

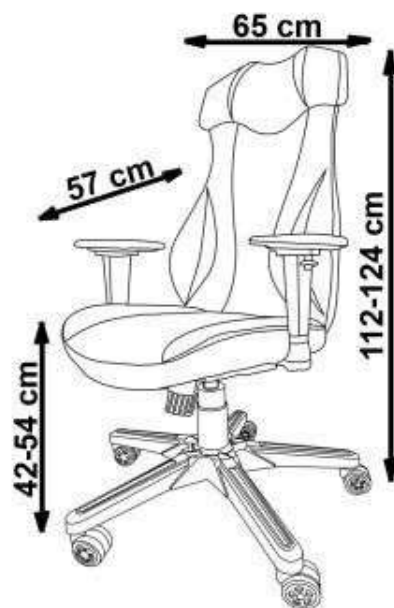

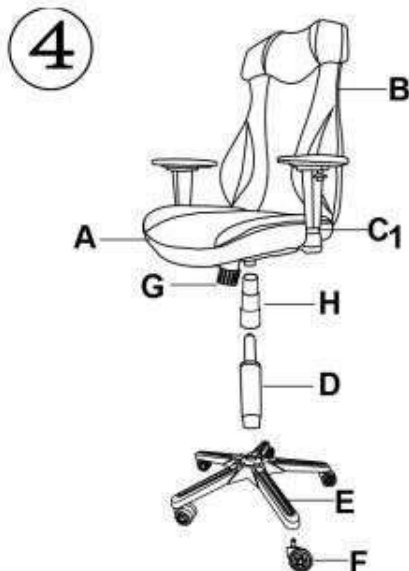

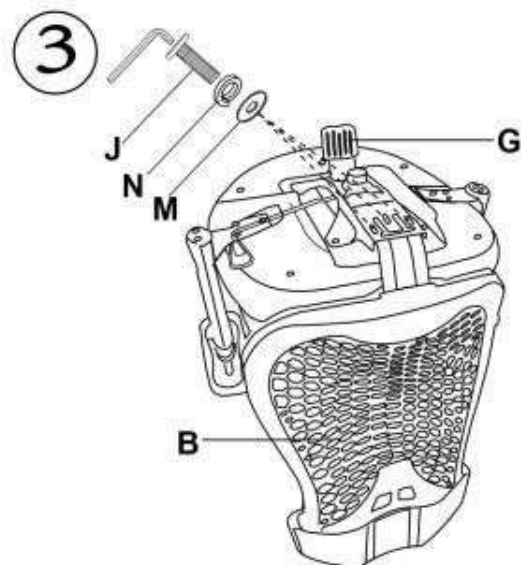

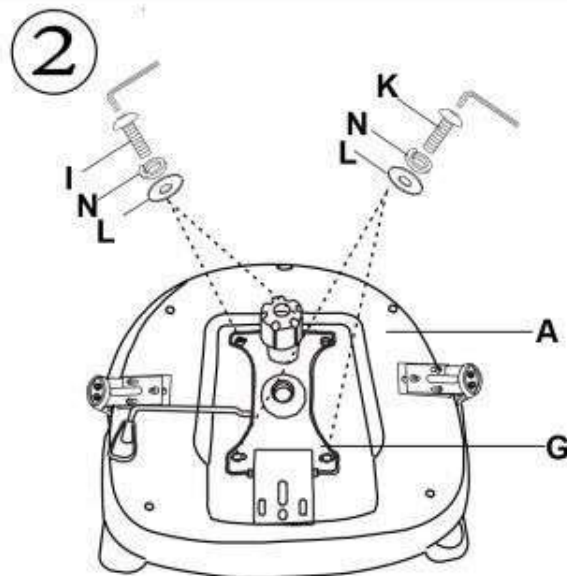

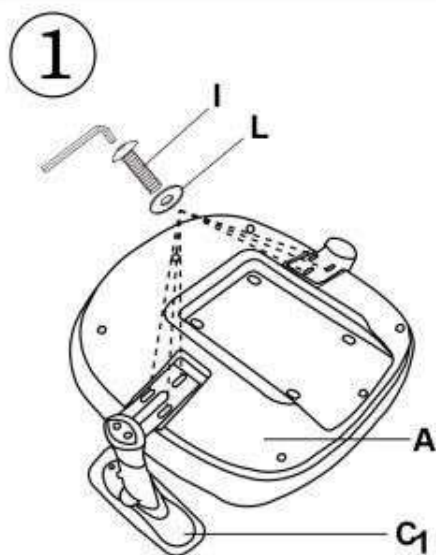







ABART



 max. 120 kg

A		1
B		1
C+C ₁		1+1
D		1
E		1
F		5
G		1
H		1
I	 M6*30MM	8
J	 M8*22MM	3
K	 M6*35MM	2
L	 M6*18*1MM	10
M	 M8*22*1.5MM	3
N	 M8	7
O		1

v.2

HALMAR Sp. z o.o.

ul. Centralnego Okręgu Przemysłowego 2, 37-450 Stalowa Wola, POLSKA / POLAND
tel. +48 15 843 28 10, fax: +48 15 842 19 57, e-mail: office@halmar.com.pl