1. Description of the controls	2
2. Operating instructions	11
3. Cleaning and maintenance	26
4. Troubleshooting	30

*Thank you for choosing one of our products.
You are advised to read this manual carefully; it contains all the information you need to use your dishwasher safely, correctly and in the most satisfactory manner.
Following the cleaning instructions provided here will keep your dishwasher's performance at peak levels in the long term.*



USER INSTRUCTIONS: *these consist of recommendations for using the appliance, a description of its controls and of the correct cleaning and maintenance procedures.*



1. Description of the controls

1.1 Upper panel

All the dishwasher controls are grouped on the upper panel. Switch-on, programming, switch-off etc. procedures are only possible when the door is open.



1	ON/OFF BUTTON
2	PROGRAM SELECTION BUTTON and INDICATOR LIGHT
3	SALT WARNIN LIGHT
4	RINSE AID WARNING LIGHT
5	ENERSAVE BUTTON and LIGHT
6	MULTIFUNCTION PRODUCT OPTION BUTTON and LIGHT
7	SPEED PROGRAM BUTTON and LIGHT
8	HALF LOAD BUTTON and LIGHT
9	PROGRAM DELAY BUTTON
10	INFORMATION DISPLAY

N.B.: symbols and styling are guideline and may vary depending on the model or version of the dishwasher purchased.

Information displayed	
Scheduled program duration	yes
Remaining program time	yes
Delayed start	1 - 24 hours
Error message	Err01,.....Err09



SETTING THE WASHING PROGRAM AND SWITCHING ON

To select the most suitable program for the dishes to be washed refer to the table below, which indicates the most appropriate program according to dish type and degree of soiling.

After using the table to identify the most appropriate washing program:



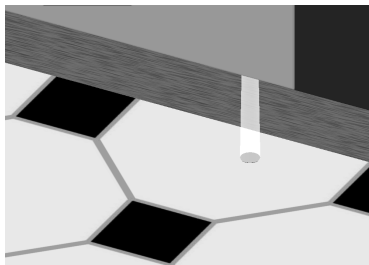
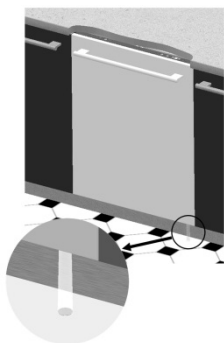

- press the **ON/OFF** button and wait for the **PROGRAM INDICATOR LIGHT** to illuminate;
- keep pressing the **PROGRAM SELECTION button (2)** corresponding to the desired program;
- close the door; after about **2"** the program will start. While it is in progress, the relative **LIGHT** will flash (indicating that the program is being executed).

PROGRAM IN PROGRESS INDICATOR LIGHT

When a program is running, a flashing light is projected onto the floor under the right-hand corner of the door. At the end of the program, the light goes out to reduce sleep mode electricity consumption.





PROGRAMME, NUMBER & SYMBOL	LOAD CROCKERY AND CUTLERY	PROGRAM PROGRESS	DURATION	CONSUMPTION	
			MINUTES (1)	WATER LITRES	POWER KWh (1)
1 SOAK 	Pans and dishes awaiting completion of the load.	Cold prewash	15	3,5	0,02
2 FAST 27 min 	Dishes with light dirt, washed immediately after use	Wash at 38°C Rinse at 50°C	27	6,5	0,70
3 DELICATE 	Delicate dishes with normal dirt.	Cold prewash Wash at 45°C Cold rinse Rinse at 70°C Dry	75	12,5	1,10
4 ECO (*) Eco EN 50242	Dishes with normal dirt, even with dried-on residues.	Wash at 45°C Cold rinse Rinse at 55°C Dry	**	**	**
5 AUTO 45-65 Auto 45°-65°  IEC/DIN ***	Dishes with normal dirt, even with dried-on residues.	When the "AUTO" program is selected, the dishwasher recognises the type of dirt and automatically adjusts the washing parameters as appropriate.			
6 INTENSIVE  ****	Very dirty pans and dishes, even with dried-on residues.	Hot prewash Wash at 70°C 2 cold rinses Rinse at 70°C Dry	135	15,5	1,60

IMPORTANT: see “NOTES AND REFERENCES” table on the following pages.







The washing cycle will not take place if the dishwasher door is left open or not properly closed.



QUICK TIME PROGRAMS

(see relevant section for explanation of functioning modes)

PROGRAMME NUMBER E SYMBOL	LOAD CROCKERY AND CUTLERY	PROGRAM PROGRESS	DURATION	CONSUMPTION	
			MINUTES (1)	WATER LITRES	POWER KWh (1)
7 DELICATE SPEED 	Delicate dishes with normal dirt.	Wash at 50°C Cold rinse Rinse at 70°C	60	9,5	1,00
8 ECO SPEED 	Dishes with normal dirt, even with dried-on residues.	Cold prewash Wash at 60°C Cold rinse Rinse at 70°C	70	12,5	1,25
9 NORMAL SPEED Auto 45°-65° 	Dishes with normal dirt, washed immediately after use	Cold prewash Wash at 70°C Cold rinse Rinse at 70°C	75	14	1,40
10 STRONG and FAST 	Mixed dishes with normal dirt without dried-on residues.	Wash at 65°C Cold rinse Rinse at 70°C	50	10	1,20

IMPORTANT: see “NOTES AND REFERENCES” table on the following pages.



The washing cycle will not take place if the dishwasher door is left open or not properly closed.



NOTES AND REFERENCES

Only run the soak program with half loads.

Options **cannot** be used with the soak program.

The **ENERSAVE** option (if featured) cannot be used with **soak**, **ultra clean**, or any programs **which do not include** the final drying stage.

*	Standard programme under EN 50242 . If present, the ENERSAVE option must be enabled .
**	See information sheet provided
***	IEC/DIN reference programme. If present, the ENERSAVE option must be enabled .
****	Reference program for laboratories: Detergent: 20g in the dispenser + 10g in the door or tablet. Configuration : see photo in "Using the baskets".
(1)	Program consumption and duration figures have been measured in accordance with the EN 50242 standard. Values may vary depending on intake water and room temperatures and the type and quantity of dishes loaded.

REFERENCES for the **ENERGY LABEL** supplied with the dishwasher:

- Annual energy consumption is based on **280 standard wash cycles** with cold water and consumption of low-energy operating modes. Actual consumption depends on the way in which the appliance is used.
- Water consumption is based on **280 standard wash cycles**. Actual consumption depends on the way in which the appliance is used.
- Information refers to the **EN 50242 STANDARD** programme (identified in the programmes table), which is the most effective in terms of combined energy and water consumption. The programme is recommended for dishes with a normal level of dirt.
- Drying efficiency class on a scale from "**G**" (minimum efficiency) to "**A**" (maximum efficiency).



1.2 Washing programs

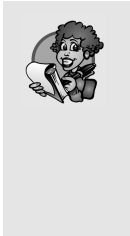

Before starting a washing program make sure that:

- The water supply tap is **open**.
- The **correct amount of detergent** has been added to the **dispenser**.
- The baskets have been **correctly loaded**.
- The spray arms are able to **rotate freely** and without obstruction.
- The dishwasher door is **securely closed**.

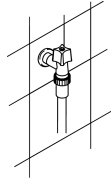

Warning:

during the initial phase of the washing program, the operation of sprayers is not perceived because they start rotating about 5 minutes after the start. This is the normal operation of the washing cycle.

QUICK TIME PROGRAMS



QuickTime

Select this option together with any washing program (except the soak program) to **SHORTEN** the cycle by from a minimum of 10% to a maximum of 55%, depending on the cycle selected. To activate this option, press the **QUICK TIME** button (light comes on) after selecting the program required. The option is automatically deactivated at the end of the program.



ENERSAVE



EnerSave

This option further **reduces energy** consumption by opening the door at the end of the cycle for more effective drying. At the end of the wash an automatic device releases the door, which slowly opens by a few centimetres. This allows optimal drying even with low rinsing temperatures, for significant **energy saving**.

The dishwasher remains in an **idle state** between the rinse stage and the end of the cycle to allow proper drying (the display shows the time left until the end of the cycle). Opening the door at this stage causes the cycle to **stop** and **ends** the program.

The program end is signalled by a short beep and the flashing of the indicator lights for programs 5 and 6.

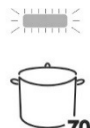

Enersave is activated automatically if the selected program is compatible with the option. It can be deactivated before the program is started.



If this function is active, **never prevent the door from opening** by any means, clear the space necessary to allow the opening of the door. **Do not force the closure of the door** before the end of cycle signal, because this would damage the mechanism.



FlexiZone

SPREAD HALF LOAD

Suitable when there are not many dishes to be washed, it saves energy and reduces the program duration. Place dishes in both baskets then load the detergent dispenser than less than the normal amount for a full load.



Flexi Tabs

Flexi Tabs

Specifically for washing with combination detergents in **tablets**, which also contain **salt and rinse aid** (3in1) or other agents such as glass protector, steel rinse aids, etc. (4in1, 5in1...). When this option is selected, salt and rinse aid will not be dispensed even if the relative compartments contain them. If the containers are empty, the **lights will remain on**.

*If the option is not provided, we recommend the use of **conventional products** (separate detergent, salt and rinse aid), because with conventional washing cycles, combined products might create problems such as a white deposit, poor drying results and residues left on dishes.*

For further information, refer to the detergent pack.

IMPORTANT:

when no longer required, the option must be **deactivated** by pressing the relative **button** (the light goes out).



These products **are not suitable** for use with **excessively "hard"** water. If the hardness level set is higher than **H3**, when the option is activated the relative light flashes to indicate that the product is being used incorrectly; the dishwasher **will still work**, but washing results may be **poor**.



Delay

DELAYED START

The start of the washing program can be delayed to program the dishwasher to operate at the preferred time of day (e.g. overnight). Press the **PROGRAM DELAY** button to activate the option and display a **1 hour** delay. Keep pressing to select the delay required, which may be **up to 9, 12 or 24 hours depending on the model**.

When the door is closed, the appliance will prewash the dishes, after which the "program delay" set will come into effect.



CANCELLING THE CURRENT PROGRAM

- To cancel the currently selected program, open the door and hold down the **PROGRAM SELECTION**  button until the program indicator light **goes out**; “P0” appears on the display.

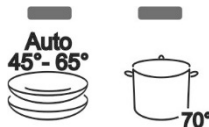

- Close the door.
- After approximately 1 minute the dishwasher will advance to the end of cycle; “End” appears on the display.

CHANGING THE PROGRAM

To change the program in progress, simply open the door and select a new program. When the door is closed the dishwasher will automatically select the new program.



TO SAVE ON ENERGY! ... AND PROTECT THE ENVIRONMENT

- Always try to run the dishwasher **fully loaded**.
- Do not wash the dishes in running water.
- Use the washing program that is **most appropriate** for each type of load.
- Do not carry out any preliminary rinsing.
- If available, connect the dishwasher to a hot water supply up to 60°C.
- Use the **ENERSAVE** option.

TO CUT DOWN ON DETERGENT CONSUMPTION! ... AND PROTECT THE ENVIRONMENT

The phosphates contained in dishwasher detergents are harmful to the environment. To avoid using excessive amounts of detergent and to save on electricity, observe the following:

- separate** the more delicate items from dishes that are more resistant to aggressive detergents and high temperatures;
- do not pour** the detergent directly on the dishes.



If the door has to be opened while washing is in progress, the program will be interrupted. The relative light will keep flashing and a beeper will signal that the cycle has not been completed. You must wait about **1 minute** before closing the door to restart the program. When the door is closed the program will continue from where it was interrupted. This operation should **only be carried out if strictly necessary**, because it might cause problems in execution of the program.



END OF CYCLE

At the end of the washing cycle the dishwasher gives a short acoustic signal and the display show "End", after which the dishwasher switches off automatically to reduce sleep mode electricity consumption.



To switch the dishwasher back on, the **ON/OFF** button must be pressed.

ENERGY MANAGEMENT

After **5 minutes of waiting** (washing cycle completed, stopped or set but not started) the dishwasher switches to a **standby** state to reduce energy consumption.

In this state, the dishwasher indicator panel (lights or display depending on model) functions more slowly (**switch-on once every 5 seconds**).

REMOVING THE DISHES

At the end of the washing program, wait at least **20 minutes** before removing the dishes, to allow them to cool down. To prevent any water droplets on the upper basket from falling on the dishes in the lower basket, it is **advisable** to unload the lower basket first, and then the upper basket.



2. Operating instructions

Once the dishwasher has been correctly installed, prepare for use as follows:

- Adjust the water softening system;
- Add the regenerating salt;
- Add the rinse aid and detergent.

2.1 Using the water softening system



The amount of scale contained in the water (water hardness index) can cause whitish staining on the dry dishes, which tend to become dull over time. The dishwasher is equipped with an automatic softening system which uses a special regenerating salt to reduce the hardness of the water. The dishwasher is factory set for water hardness level **3** (average hardness).

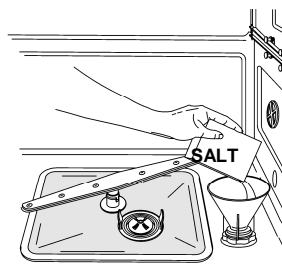

When using water of medium hardness, the regenerating salt container should be refilled after approximately **20 washing cycles**. The salt container can hold approximately **1.7 Kg** of salt in grains. The container is situated at the bottom of the dishwasher. After removing the lower basket, unscrew the salt container cap by turning it anticlockwise and pour in the salt using the funnel supplied with the dishwasher. Before replacing the cap, remove any salt residues from around the opening.



- *When using the dishwasher for the first time, in addition to the salt it is also necessary to add **one litre of water** to the container.*
- *Each time the salt container is refilled, make sure that **the cap is securely closed**. The mixture of water and detergent must never penetrate the salt container, as this would compromise the operation of the regeneration system. In the event of this occurring, the warranty will be invalidated.*
- ***Only** use regenerating salt specially formulated for domestic dishwashers. If using salt tablets, **do not fill the container completely**.*



- **Do not use table salt** as it contains insoluble substances which, over time, may damage the water softening system.
- When necessary, refill the regenerating salt container **before starting the washing program**. In this way, the excess saline solution will be immediately removed by the water; the prolonged presence of salt water inside the tank may lead to **corrosion**.





Be careful not to confuse the salt and detergent packages; adding detergent to the salt container will **damage** the water softening system.

ADJUSTING THE WATER SOFTENING SYSTEM

(available in all programs except the soak program)

The dishwasher is equipped with an electronic device for adjusting the water softening setting according to the hardness of the water. To adjust the water softening setting, proceed as follows.



- Keep the **PROGRAM DELAY**  button **pressed for a few seconds**, until the **H-** symbol, followed by the set value, appears on the **3-FIGURE DISPLAY**.
- The **PROGRAM DELAY**  button can be pressed again to select the most suitable hardness value (**h.-0, h.-1, h.-2...h.-6**). Refer to the "Water hardness table" to select the value.
- To exit the programming mode press one button or do not touch the keypad for **2 seconds**.



WATER HARDNESS TABLE

WATER HARDNESS		SETTING
German Degrees (°dH)	French Degrees (°dF)	
0 - 6	0 - 11	h.-0 NO SALT
7 - 10	12 - 18	h.-1
11 - 15	19 - 27	h.-2
16 - 21	28 - 37	h.-3
22 - 28	38 - 50	h.-4
29 - 35	51 - 62	h.-5
36 - 50	63 - 90	h.-6

Contact your local water board for information on the hardness of your water supply.

After adjustment or display of the current setting, simply do not touch the button for a few seconds; the dishwasher will automatically return to standard mode, quitting the adjustment mode.

2.2 Using the rinse aid and detergent dispensers

The detergent and rinse aid dispensers are situated on the inner part of the door: the **detergent dispenser** is on the left, and the **rinse aid dispenser** is on the right.

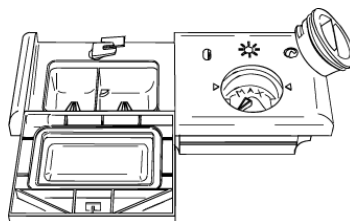

With the exception of the **SOAK** program, before every washing cycle it is necessary to add the required amount of detergent to the **detergent dispenser**. The rinse aid, on the other hand, should only be added as required.



ADDING THE RINSE AID

The rinse aid helps the dishes dry faster and prevents the formation of scale deposits and staining; it is automatically added to the water during the final rinse cycle, from the container situated on the inner side of the door.

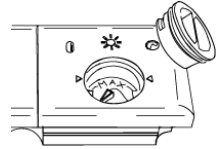

To add rinse aid:

- Open the door.
- Rotate the container cap anticlockwise by $\frac{1}{4}$ of a turn and remove it.
- Add the rinse aid until the container is full (approximately 140 cc). The optical level indicator on the side of the cap should be completely obscured. Refill the rinse aid when the optical level indicator becomes clear again, or when the rinse aid warning light illuminates.
- Replace the cover and turn it in a clockwise direction.
- Use a cloth to remove any spillage of rinse aid which might lead to the formation of excess foam.

ADJUSTING THE RINSE AID DISPENSER SETTING

The dishwasher is factory set for medium water hardness. However it is possible to change the setting by turning the dispenser's selector to the desired position: the amount of rinse aid dispensed is proportional to the selector position.

- To adjust the rinse aid setting, rotate the dispenser cap through a quarter turn in an anticlockwise direction and remove it.
- Then use a screwdriver to rotate the rinse aid selector to the desired position.
- Replace the cap, turning it clockwise.



- *The amount of rinse aid must be **increased** if the washed dishes appear dull or feature circular stains.*
- *If, on the other hand, the dishes are sticky or have white streaks, it is necessary to **reduce** the rinse aid setting.*



ADDING THE DETERGENT

To open the detergent dispenser cap, lightly press the button **P**. Add the detergent and close the cap carefully.

During the washing cycle, the dispenser will be opened automatically.

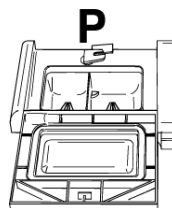
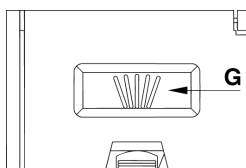
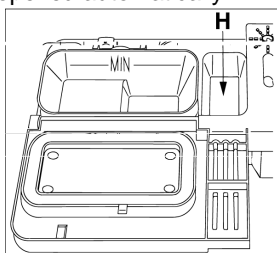

- *When a program with hot prewash is selected (see program table), extra detergent must be placed in the cavity **G/H** (depending on models).*
- *Use **only** detergents specially formulated for dishwashers. For optimal washing results it is important to use a good quality detergent.*
- *The detergent packs must be sealed and stored in a dry place to prevent the formation of lumps which may negatively affect washing results. Once opened the detergent packs should not be kept for too long, otherwise the detergent loses its effectiveness.*
- *Do not use detergents formulated for washing dishes by hand, because they produce a great deal of foam and may negatively affect the operation of the dishwasher.*
- *Add the correct amount of detergent. An insufficient amount of detergent will result in a partial removal of dirt from the dishes, whereas an excessive amount is wasteful and does not improve the washing results.*
- *The market offers liquid and powder detergents with differing chemical compositions, which may contain **phosphates**, or be phosphate-free but contain **natural enzymes**.*
 - *Detergents containing **phosphates** are more effective against grease and starch at **temperatures above 60°C**.*
 - ***Enzyme** detergents, on the other hand, are also effective at lower temperatures (**from 40 to 55°C**) and are more easily biodegradable. With enzyme detergents it is possible to obtain at low temperatures comparable results to those which can only be achieved at **65°C** using traditional detergents.*

*For the safeguarding of the environment we recommend the use of **phosphate- and chlorine free** detergents.*



The introduction of detergent into the rinse aid dispenser, even in liquid form, will damage the dishwasher.

2.3 General warnings and recommendations



Before using the dishwasher for the first time, it is advisable to read the following recommendations concerning dish types to be washed and their loading.

There are generally no constraints on the washing of domestic dishes, but in certain cases it is necessary to take their characteristics into account.

Before loading the dishes into the baskets it is necessary to:

- *remove coarse food remains: e.g. bones, fish-bones, etc. which may clog the filter or damage the wash pump.*
- *soak any pots or pans with burnt-on food remains on the bottom to facilitate removal, then load them into the LOWER BASKET.*

There is no need to pre-wash the dishes under running water before loading them into the baskets since this only wastes water.

Correct loading of the dishes helps ensure optimal washing results.



WARNING!

- *Make sure that the dishes are securely in place so that they cannot tip over or obstruct the rotation of the spray arms during the washing cycle.*
- *Do not place very small objects in the baskets as these could fall and obstruct the spray arms or the wash pump.*
- *Containers such as cups, bowls, glasses and pots should always be loaded with the opening facing downwards and with any cavities at an angle, to allow the water to drain out.*
- *Do not stack dishes or place them in such a way that they cover one other.*
- *Do not place glasses too close together because they may knock against each other and break, or there might be staining at the point where they touch.*

MAKE SURE that the items being washed are dishwasher-safe.

Items which are not dishwasher-safe:

- **Wooden dishes, pots or pans:** these may be damaged by the high washing temperatures.
- **Handcrafted items:** these are rarely suitable for washing in a dishwasher. The relatively high water temperatures and the detergents used may damage them.
- **Plastic dishes:** heat resistant plastic dishes must be washed in the upper basket.
- **Dishes and objects in copper, tin, zinc or brass:** these tend to stain.
- **Aluminium dishes:** items made from anodised aluminium may lose their colour.
- **Silverware:** silver items may stain.
- **Glass and crystal:** in general, glass and crystal objects can be washed in the dishwasher. However, certain types of glass and crystal may become dull and lose their clearness after many washings. Therefore, for these items we recommend using the least aggressive program available.
- **Decorated items:** the decorated objects available on the market are generally able to withstand washing in the dishwasher, although the colours may fade after a great many washes. If in doubt as to the fastness of the colours, it is advisable to wash just a few items at a time for approximately one month.



2.4 Using the baskets

The dishwasher has a capacity of **13 place-settings**, including serving dishes.

LOWER BASKET

The lower basket receives the full force of the lower spray arm, and should therefore be used for the “toughest” items with a heavier degree of soiling.

All types and combinations of loads are permitted, provided that the dishes, pots and pans are arranged with all the soiled surfaces exposed to the water jets coming from the bottom.

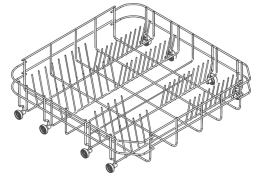

With fixed supports

To make the most of the space inside the basket when loading large items, certain models are equipped with tip-up supports for plates in 2 or 4 sections.

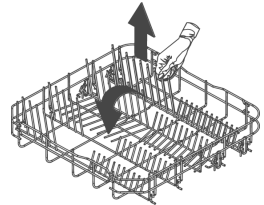

With tip-up supports

BOTTOM BASKET INSERTS

Some models are equipped with bottom basket inserts which improve the drying of dishes. The inserts are supplied in the accessories bag; to use them, simply fit them into place as shown.

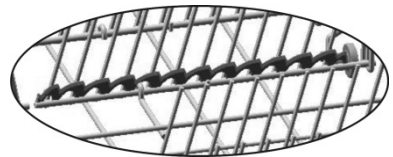
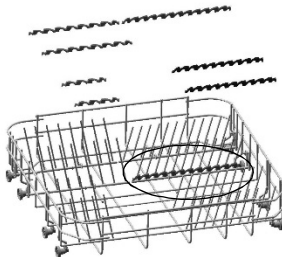



LOADING THE LOWER BASKET

Carefully load flat plates, soup plates, dessert and serving dishes, positioning them vertically. Pots, pans and their covers must be loaded upside down. When loading soup plates and dessert bowls, be sure to leave a gap between them.

Loading examples:

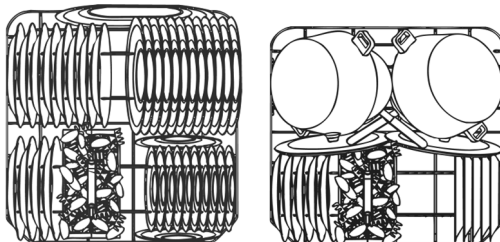

UPPER BASKET

The upper basket should be loaded with small or medium-sized items such as glasses, small plates and saucers, tea or coffee cups, shallow bowls and light objects. If the upper basket is used in the lowermost position, it can also be loaded with serving dishes, provided they are only lightly soiled.

LOADING THE UPPER BASKET

Load plates facing forward; cups, bowls etc. must always be facing downwards. The left side of the basket can be loaded with cups and glasses on two levels. In the centre section, plates and saucers can be loaded vertically into the supports provided.

Loading examples:

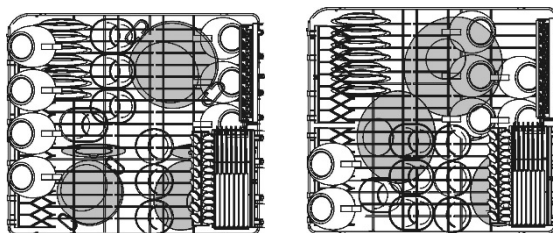



CUTLERY BASKET

The basket has **removable top grids** into which items of cutlery should be inserted to keep them properly spaced and allow water to pass between them effectively. The top grids and central lid are in the **bag of accessories**. The **central lid** functions as a **lid only**.

The top grids can be **detached** and **used separately**.

The cutlery should be arranged in an orderly manner inside the basket, with the handles pointing downwards. Take care during loading to avoid injury from the knife blades. The basket is suitable for all types of cutlery, except those long enough to interfere with the upper spray arm. Ladles, wooden spoons and cooking knives can be placed in the upper basket, **making sure that the knife blades do not protrude from the basket**.

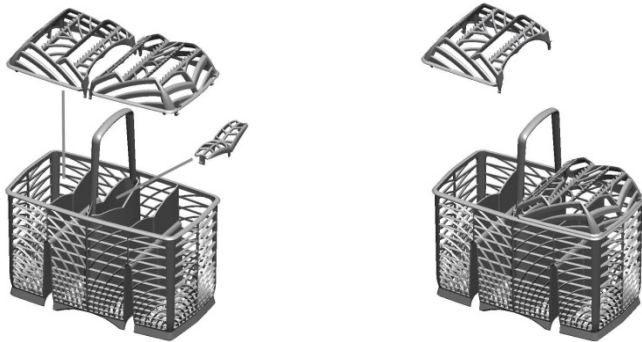

The cutlery basket slides across the dishwasher and can be **placed in any position** to allow optimal use of the space in the bottom basket.

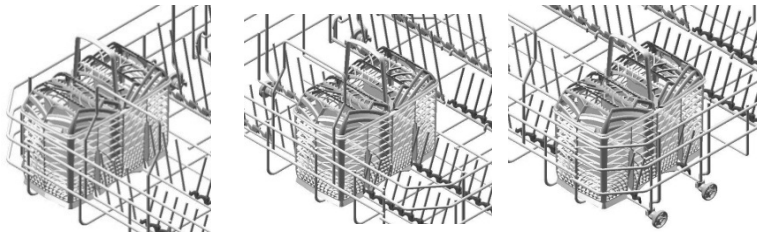



FLEXI DUO TOP RACK (on some models only)

This comprises **two independent** sliding, pull-out tray racks for easier loading/unloading of cutlery. Various loading systems and configurations are possible. For example, **tea cups** can be loaded with the **right-hand** rack set in the **low position**, while the left-hand rack or both can be removed to allow **large dishes** to be put in the **top basket**. In order to position the right hand basket in a low position, the upper basket has to be adjusted so that it is in the lowest position (see “adjusting the upper basket”).

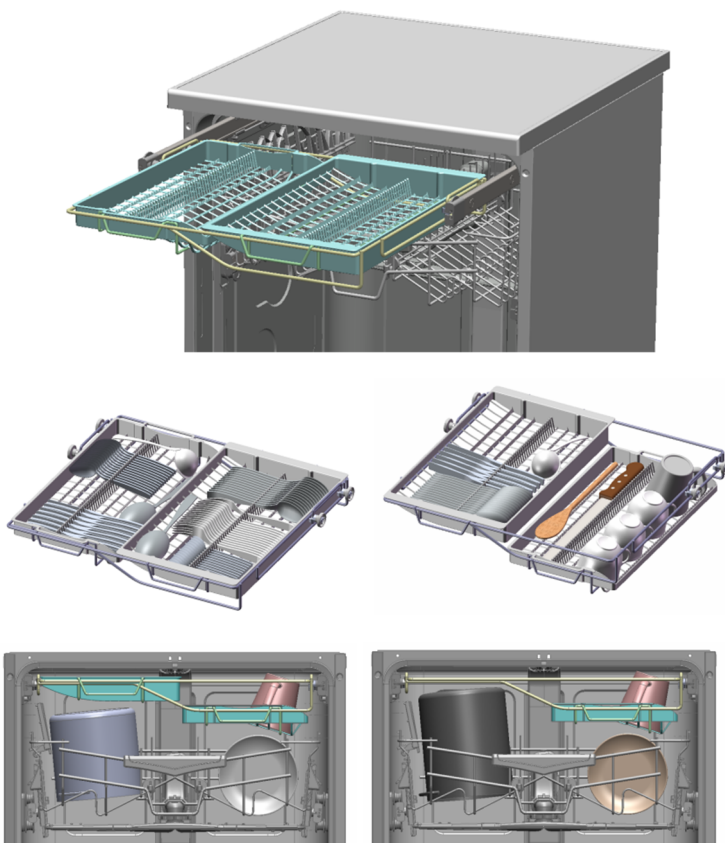



Examples of loading for intensive dirt:

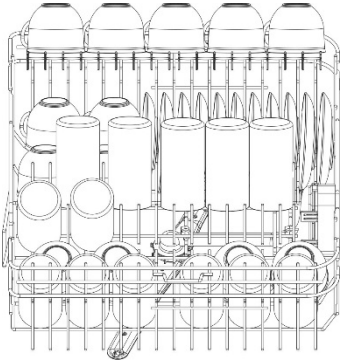
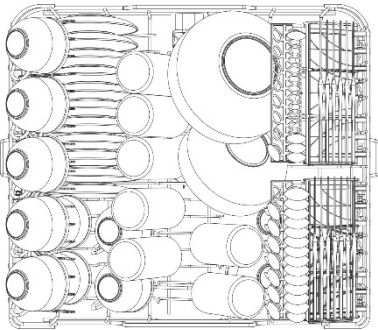
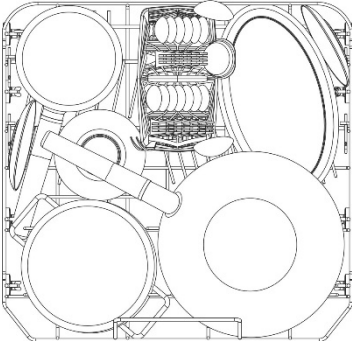



**Examples of loading for intensive dirt:
FLEXI DUO TOP RACK (on some models only)**

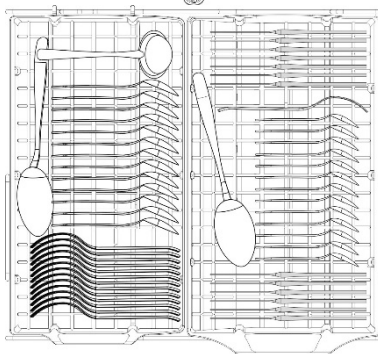
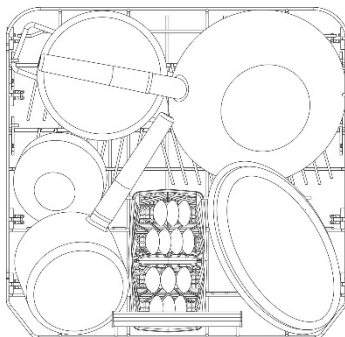
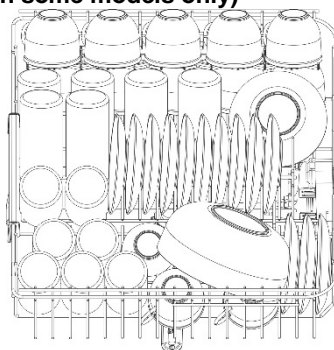
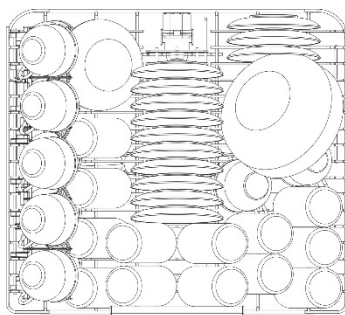



Depending on the models, the basket may be equipped with some or all of the following accessories:

- Supports for cups or long objects (ladles, spoons...), on the left; can be tipped to the vertical position when not in use.
- Long-stemmed glass holder, on the left; to use, simply lift and fix onto the hooks provided.
- Cutlery racks, on the right, designed for knives and teaspoons; for teaspoons, pull out the sliding support. The racks can be tipped to the vertical position when not in use.
- Fixed or movable racks in the middle. The movable supports can be fixed vertical, resting on the bottom of the basket when not in use, or set in the intermediate position, as required.

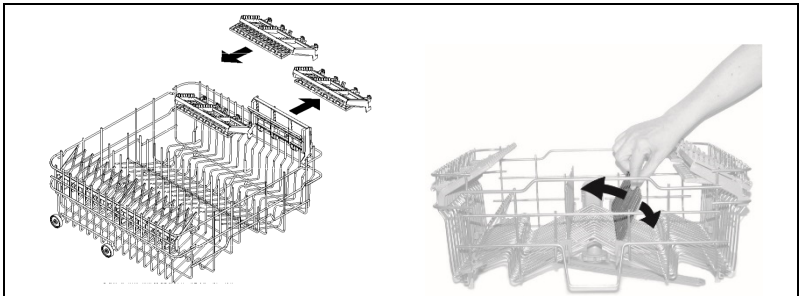
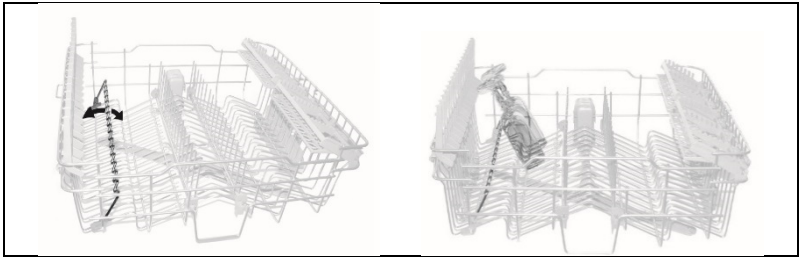



ADJUSTING THE UPPER BASKET

The height of the top basket can be adjusted to allow large dishes or pans to be placed in the bottom basket.

The adjustment procedure may be type **A** or **B**, depending on the dishwasher model purchased.

Version A: pull-out with adjustment in two positions.

- Pull out both the basket guides.
- Remove the stops, first releasing them as shown in the diagram.
- Pull out the basket.
- Fit the upper or lower pair of wheels into the guide, depending on the setting required;
- Return the stops to their original position.

The left hand and right hand sides of the basket **must always be set at the same height**.

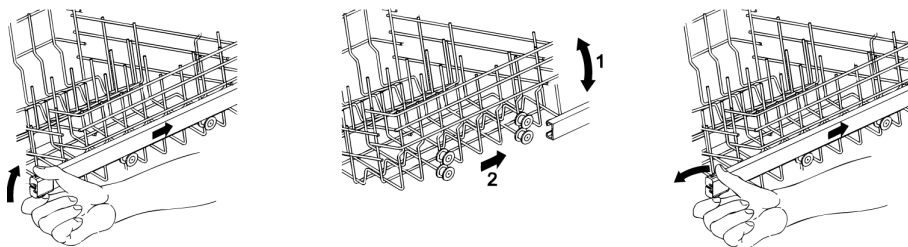

Version B: with adjustment in three positions on both sides.

The sides of the basket **must always be set at the same height**.

- Raise the basket by pulling on the top edge (1), to the first or second catch depending on the height required.
- To lower the basket, first release it by pulling the release lever (2).

Adjustment is also possible with the basket loaded, but in this case when lowering the basket it should be held steady with one hand to avoid knocking the dishes.

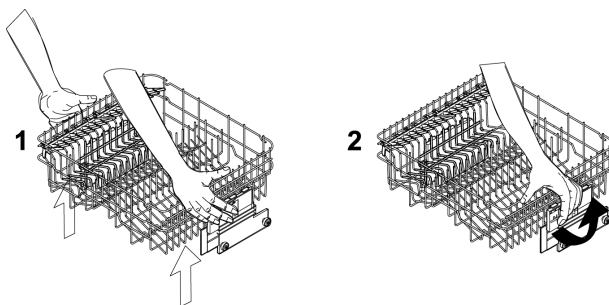



3. Cleaning and maintenance



Before carrying out any work, always unplug the appliance from the electrical supply or switch off the all-pole disconnection device.

3.1 General warnings and recommendations

Avoid the use of acidic or abrasive detergents.

Clean the outer surfaces and door-lining of the dishwasher regularly using a soft cloth moistened with water or with a normal detergent suitable for painted surfaces. Clean the door gaskets with a damp sponge. Periodically (once or twice a year) it is advisable to clean the tank and gaskets, using a soft cloth and water to remove any deposits.

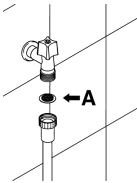

CLEANING THE WATER INTAKE FILTER

The water intake filter **A** located at the outlet of the water supply tap needs to be cleaned periodically.

After having closed the water supply tap, unscrew the end of the water intake hose, remove the filter **A** and clean it delicately under running water. Reassemble filter **A** in its seat and carefully screw the water intake hose back into position.

CLEANING THE SPRAY ARMS

The spray arms can be easily removed for periodic cleaning of the nozzles, to prevent possible clogging. Wash them under running water and carefully replace them in their seats, **checking that their rotary movement is in no way impeded.**

- To remove the **upper** spray arm, unscrew locking ring **R**.
- To remove the **lower** spray arm, simply lift it up, pulling by the central part.
- To remove the **orbital** spray arm assembly, take hold of the longer arm and pull the orbital unit upward. Wash the arms under a jet of running water and return them carefully to their seat. **After reassembly, check that the spray arms turn freely.** Otherwise, check that they have been installed correctly.

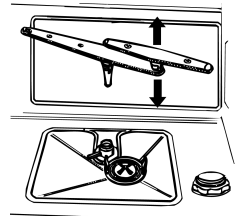
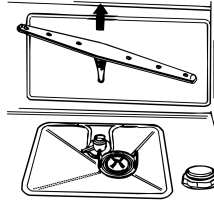
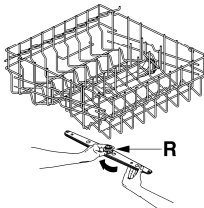



CLEANING THE FILTER UNIT

- It is advisable to periodically inspect the centre filter **C** and, if necessary, to clean it. To remove the filter, grip the tabs, turn them anticlockwise and lift upwards;
- push the centre filter **D** from the underside to remove it from the micro-filter;
- separate the two parts which make up the plastic filter by pressing the body of the filter in the zone shown by the arrows;
- remove the centre filter by lifting it upwards.

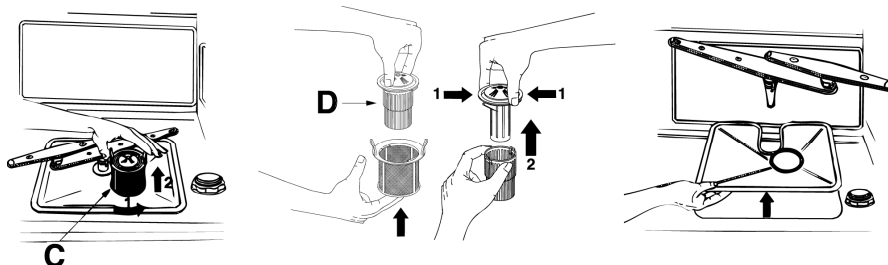

GENERAL WARNINGS AND RECOMMENDATIONS FOR CORRECT MAINTENANCE:

- The filters should be cleaned **under running water** using a stiff brush.
- **When removing the filter**, take care that there are no food residues on it. If any residues fall into the washing pit they might block hydraulic components, or foul the spray arm nozzles.
- It is essential to **thoroughly clean the filters** according to the above instructions: the dishwasher cannot function if the filters are clogged.
- **Carefully replace** the filters in their seats, to avoid damaging the wash pump.

PROLONGED DISUSE:

- Run the soak program twice in succession.
- **Unplug** the power cord from the socket.
- **Leave the door slightly open**, in order to prevent the formation of unpleasant odours inside the washing tank.
- **Fill the rinse aid dispenser.**
- **Shut off the water supply tap.**



BEFORE STARTING THE DISHWASHER AFTER PROLONGED DISUSE:

- Check that there are no deposits of sludge or rust inside the water pipe: if there are, allow the water to run from the water supply tap for a few minutes.
- **Plug the power cord** back into the socket.
- **Reconnect the water intake hose and open the tap again.**

TROUBLESHOOTING MINOR PROBLEMS

In some cases it is possible to remedy minor problems by referring to the following instructions:

If the program fails to start, check that:

- the dishwasher is connected to the electrical power supply;
- there is no power failure;
- the water tap is open;
- the dishwasher door is properly closed.
- The door won't close > The door latch was released > Use greater strength to close the door.

If water remains inside the dishwasher, check that:

- the drain hose is not kinked;
- the drain siphon is not obstructed;
- the dishwasher filters are not clogged.

If the dishes are not being cleaned properly, check that:

- the correct amount of detergent has been added;
- there is regenerating salt inside the special container;
- the dishes are being loaded correctly;
- the selected program is suitable for the dish types and their degree of soiling;
- all the filters are clean and positioned correctly;
- the spray arm nozzles are not obstructed;
- there is no object obstructing the rotation of the spray arms.



If the dishes fail to dry or remain dull, check that:

- there is rinse aid inside the special container;
- the rinse aid dispenser setting is correct;
- the detergent used is of good quality and has not lost its effectiveness (for example, through incorrect storage, with the box left open).
- Non-dry synthetic dishes.
Synthetic material has a lower heat storage capacity and is therefore harder to dry.

If the dishes show signs of streaking, staining, etc., check that:

- the rinse aid dispenser setting is not too high.

If there are visible traces of rust inside the tank:

- the tank is made of steel, and therefore any rust marks are due to external elements (fragments of rust from the water pipes, pots, cutlery, etc.). Special products are commercially available to remove such marks;
- check that the amount of detergent being used is correct. Certain detergents can be more corrosive than others.
- check that the cap of the salt container is securely closed, and that the water softening setting is correct.



If after following the above troubleshooting instructions the problem persists, call the nearest After-Sales Centre.

WARNING: any operations performed on the appliance by unauthorised persons are not covered by the warranty and shall be paid for by the user.



4. Troubleshooting

The dishwasher is equipped with a self-diagnostics system that is capable of detecting and signalling a number of possible faults

TABLE OF FAULTS DETECTED BY THE SELF-DIAGNOSTICS SYSTEM

FAULT	DESCRIPTION
Err01	The anti-flooding system (where present) has been tripped.
Err02	The water level limitation system has tripped.
Err03	The appliance cannot heat the water.
Err04	The temperature sensor is disconnected.
Err05	The appliance cannot take in the water.
Err06	The appliance cannot drain the water from the tank.
Err07	The dishwasher cannot measure the precise water quantity that has been loaded.
Err08	Problem on the water distribution system to the baskets.
Err09	Water intake system malfunction
Err11	Wash motor pump does not work

If an alarm occurs the appliance interrupts the program in progress and signals a fault.

- Alarms **Err01**, **Err02**, **Err03**, **Err04**, **Err08** and **Err09** interrupt the current program immediately.
- The **Err05**, **Err06** alarms interrupts the running program once the cause is resolved, it will bring back the execution of the program.
- The alarm **Err07** is visualized at the end of the cycle that comes, however, brought to the end since the operation of the dishwasher is not harmed.
- **Err11**: Contact the after-sales service.

To "reset" an alarm is necessary:

- Open and close the door, or turn off and on the machine. At this point is possible to program the dishwasher again.



User instructions

EN



If the malfunction persists, contact your authorised Service Centre.