



# Friends

42626





**Get excited about our new packaging!**

We're switching from plastic to paper-based packaging. That's why you might find a mix of paper and plastic in our boxes!

**Nos nouveaux emballages vous emballeront !**

Nous passons des emballages en plastique aux emballages à base de papier. C'est pourquoi vous pourriez trouver un mélange de papier et de plastique dans nos boîtes !

**¡te presentamos nuestros nuevos empaques!**

Estamos sustituyendo las bolsas de plástico por bolsas con base de papel. ¡Por eso, puedes encontrar una mezcla de papel y de plástico en nuestras cajas!

[LEGO.com/sustainable-packaging](https://www.lego.com/sustainable-packaging)





🔍 LEGO® Builder

# BUILDER



Apple and the Apple logo are trademarks of Apple Inc., registered in the U.S. and other countries and regions. App Store is a service mark of Apple Inc. Google Play and the Google Play logo are trademarks of Google LLC. Tencent and the Tencent logo are trademarks of Tencent Inc.

🔍 [lego.com/legobuilder](https://lego.com/legobuilder)

EN: Ask parents' permission before going online | DE: Eltern um Erlaubnis bitten, bevor ihr online geht | FR: Demandez l'autorisation d'un parent avant d'aller en ligne | IT: Chiedi il permesso ai tuoi genitori prima di andare online | ES: Pídeselo permiso a los papás antes de conectarte a Internet | PT: Peça autorização aos pais antes de acessar online | CN: 上网前应先征得父母同意 | PL: Prośmi o zgodzie u rodziców przed wejściem do Internetu | CS: Než půjdete na internet, požádejte rodiče o svolení | SK: Skôr než pôjdete na internet, vyspajte si s rodičmi o ich súhlas | HU: Először kérj engedélyt a szüleidtől online hozzáféréstől | RO: Cere permisiunea părinților înainte de a te conecta online | BG: Попрашай разрешение от родителите, преди да отидеш онлайн | LV: Pirms dotardas tieksmes palūdz atļauju vecākiem | ET: Ühe Interneti kasutamist küsi vanemast luba | CZ: Před přihlášením online požádejte o svolení rodičů

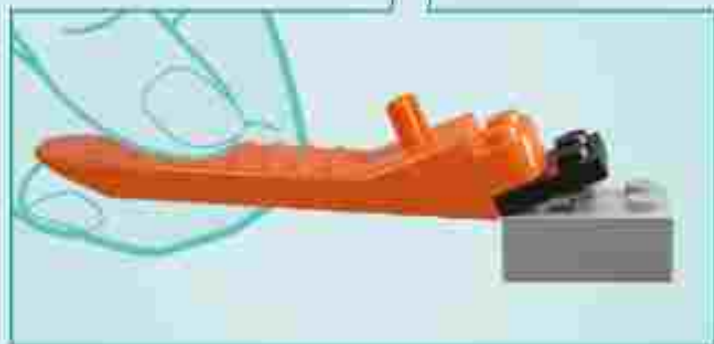

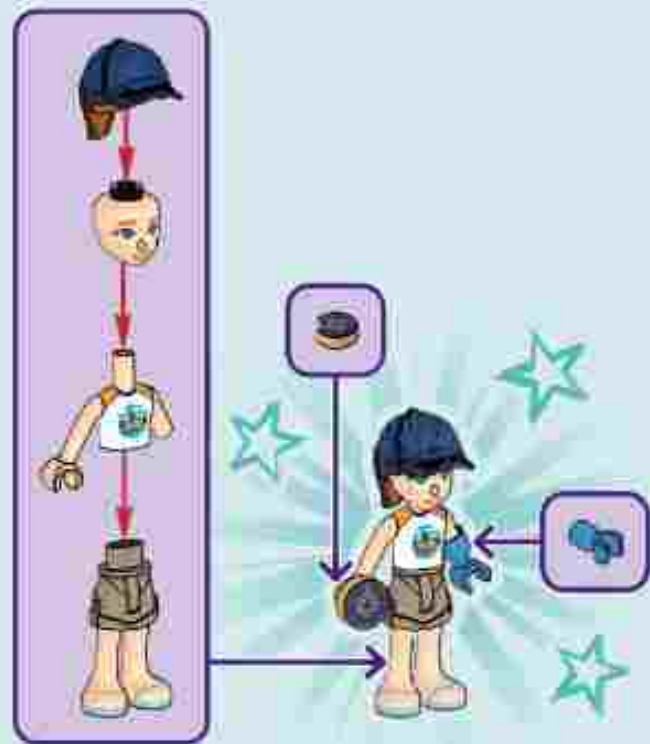

# AUTUMN







ZAC



LIANN



AUTUMN



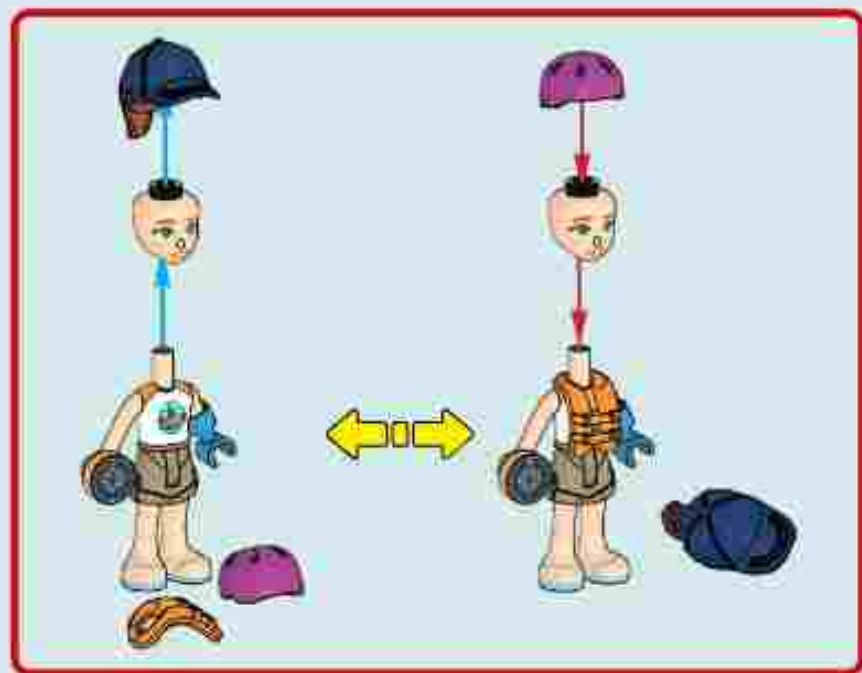



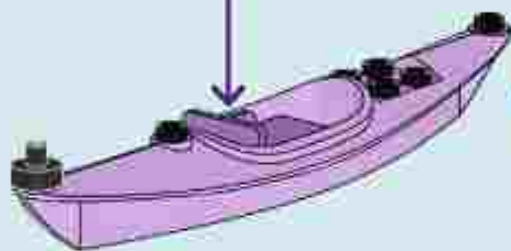
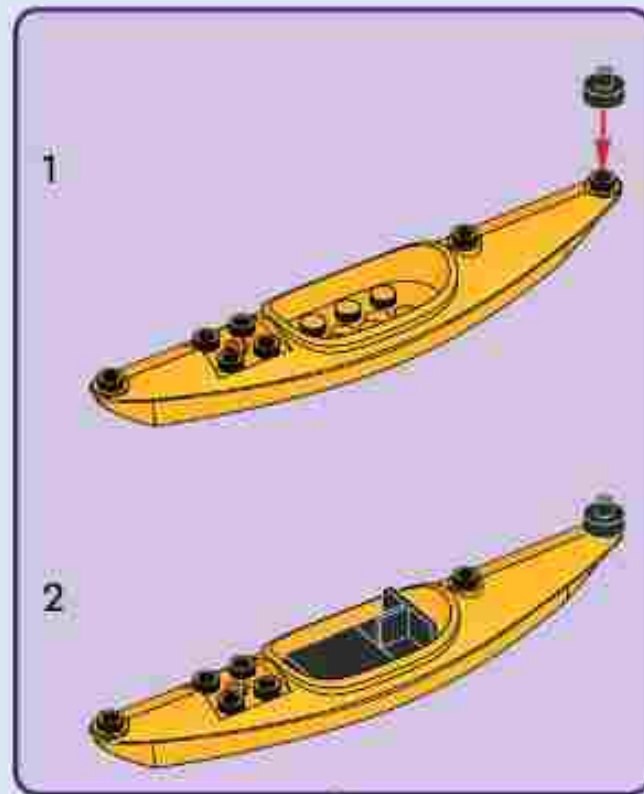
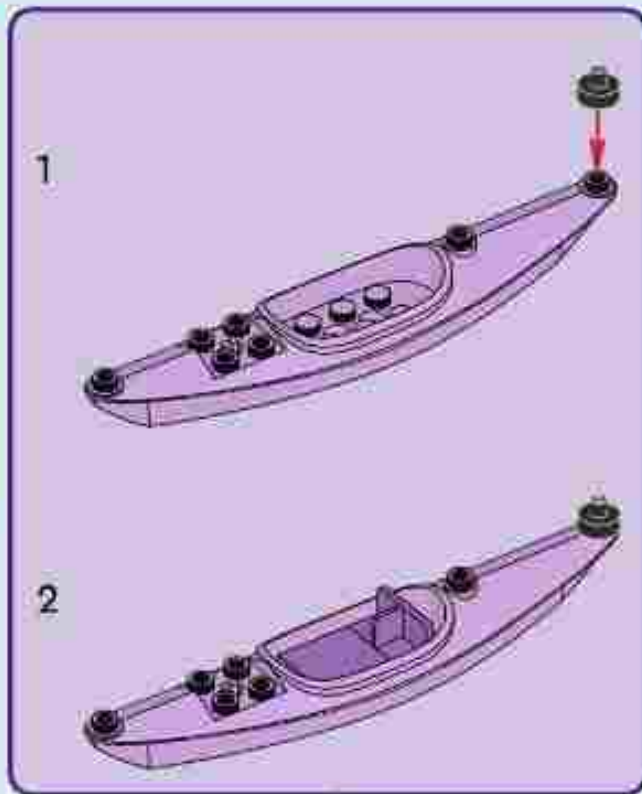
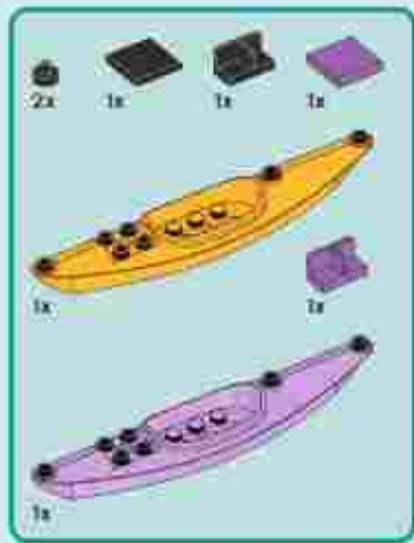

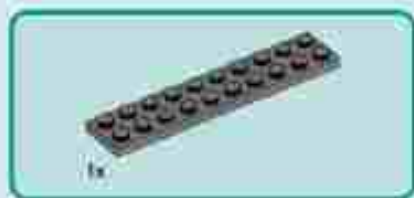

1

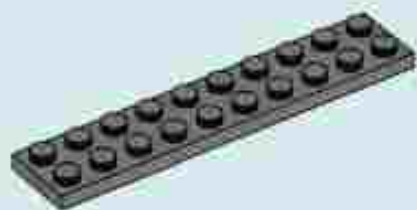

2



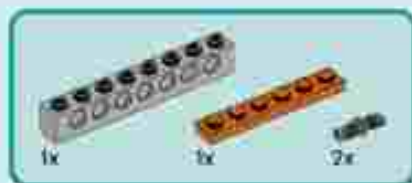

3

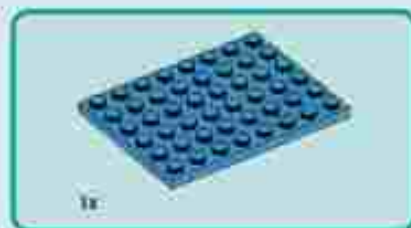
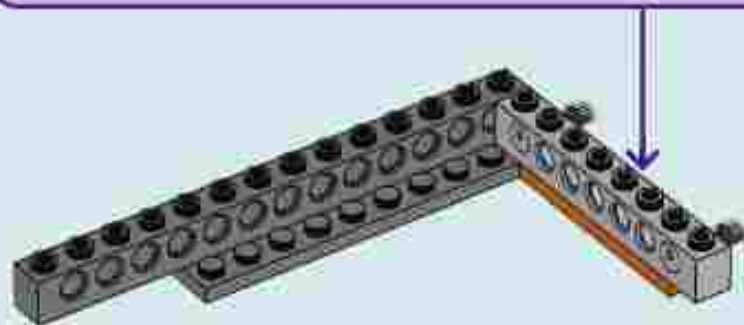
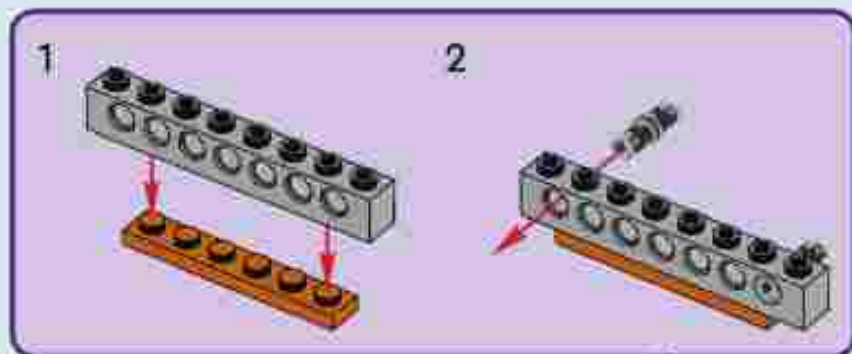

4

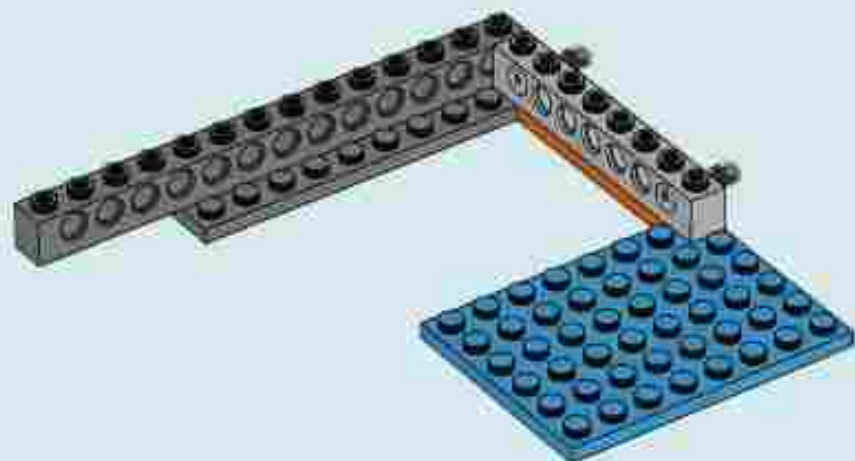



5

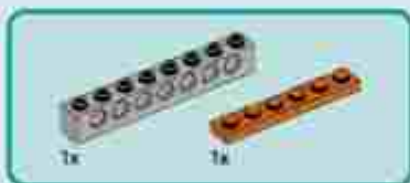
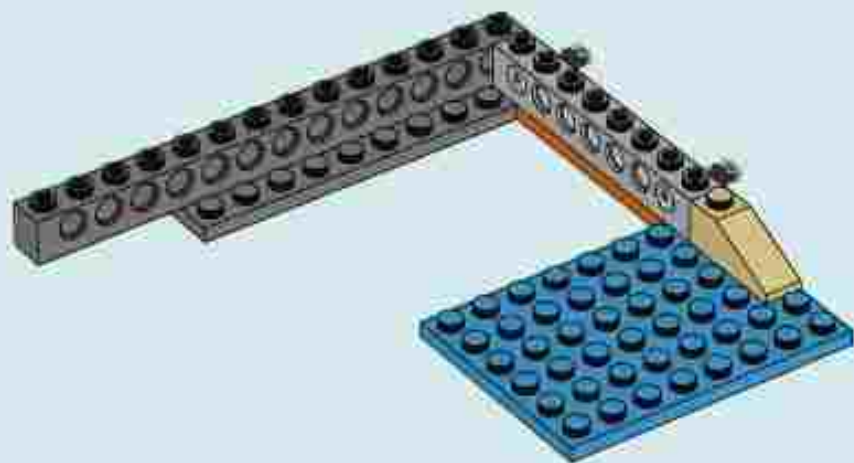

6

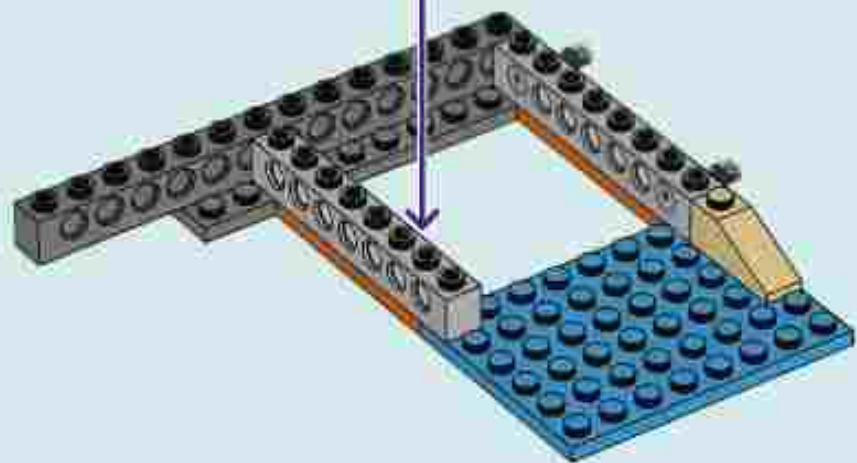
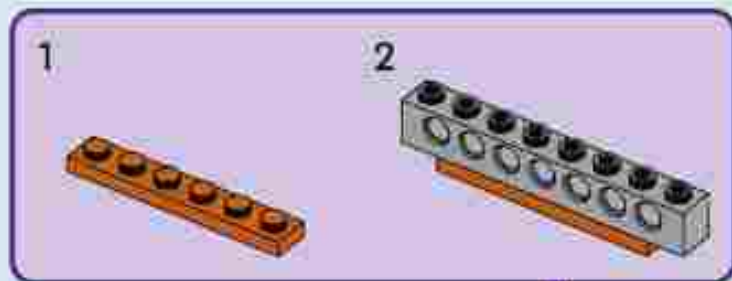



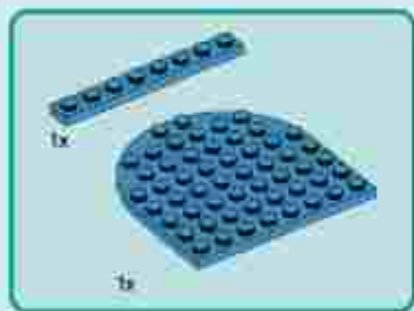

7

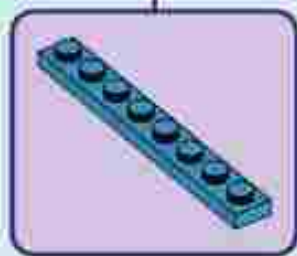
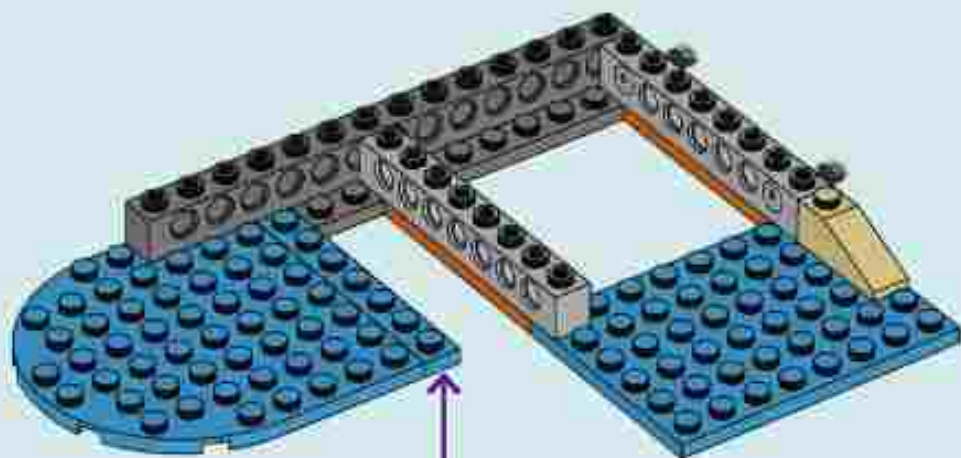



8

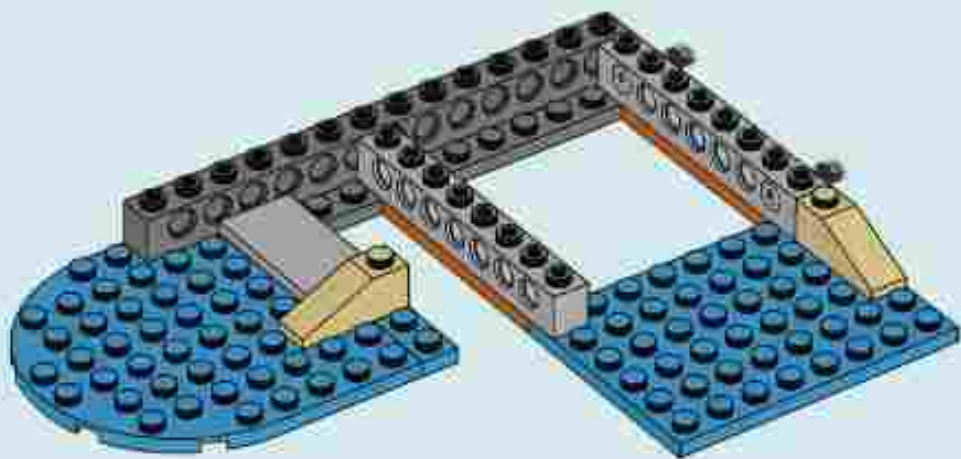



9

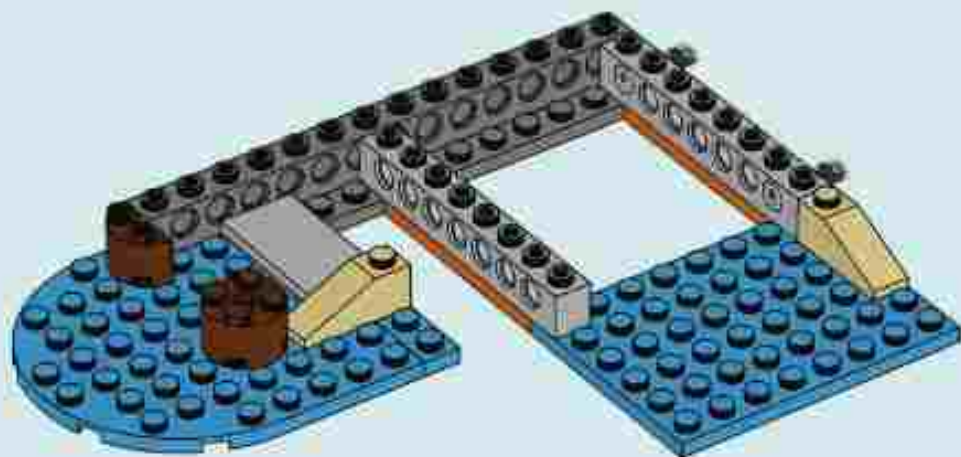



10

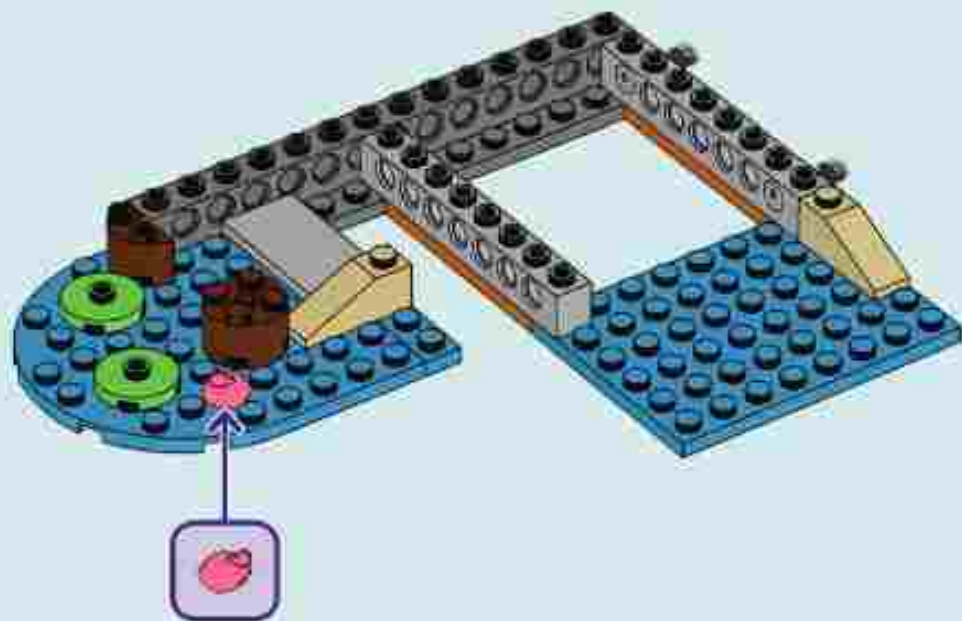





11

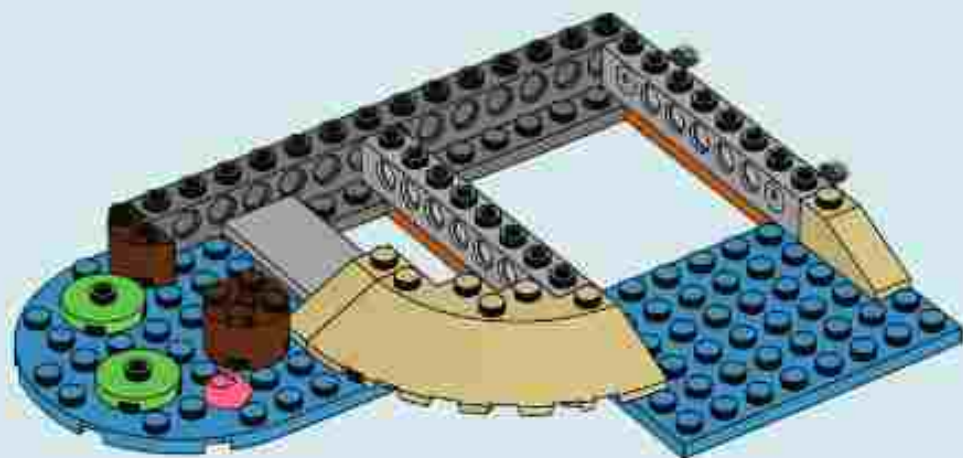

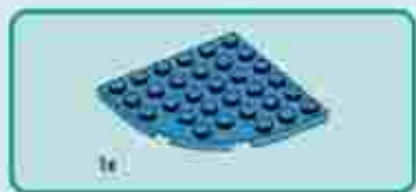

12

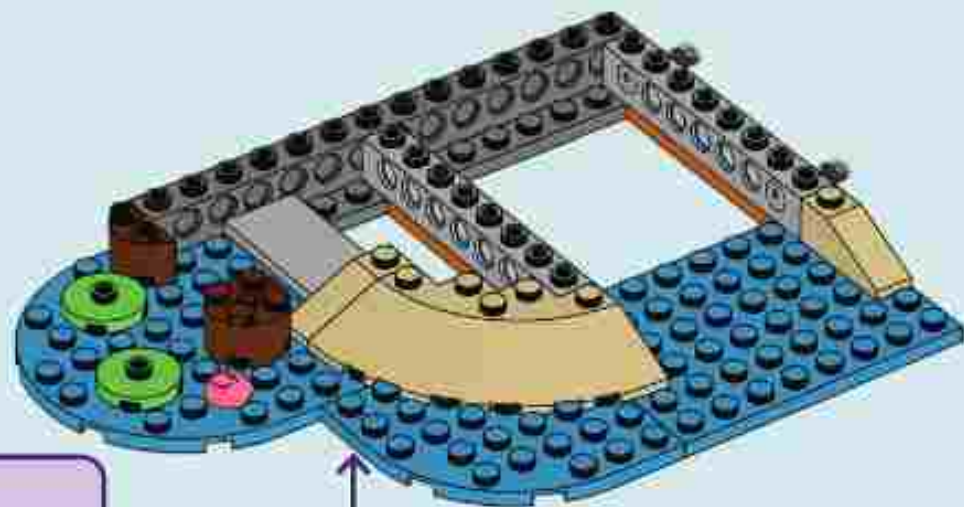



13

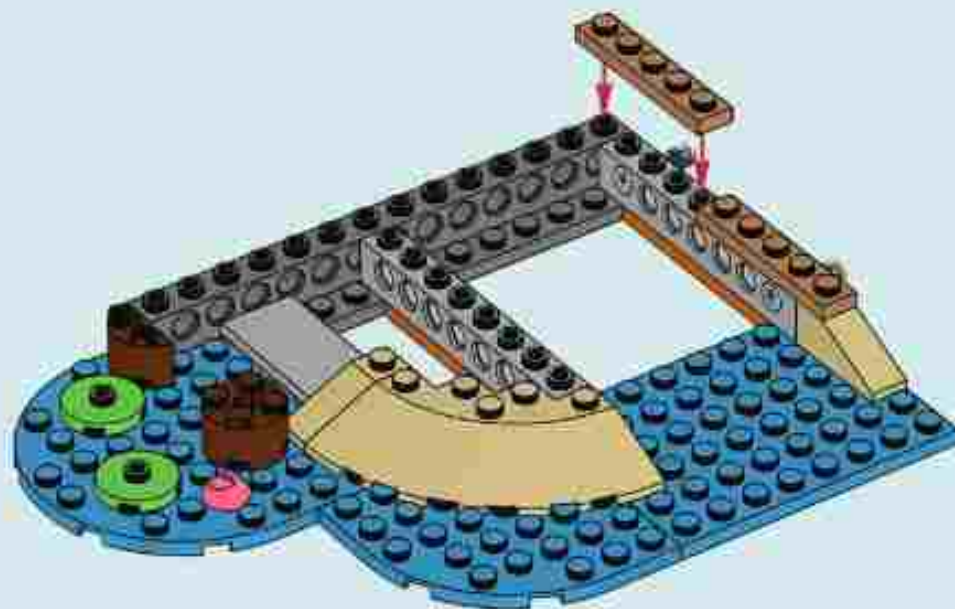

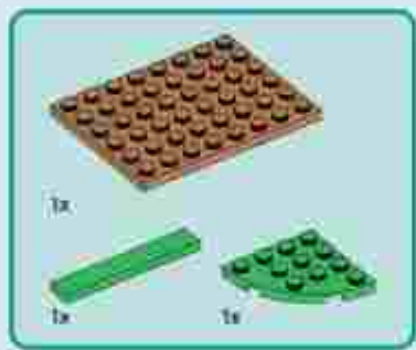

14

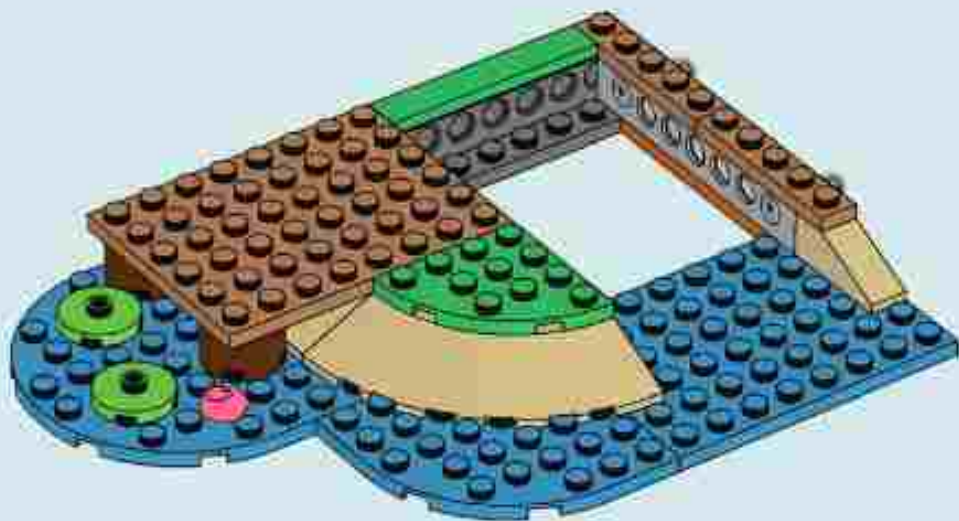





15

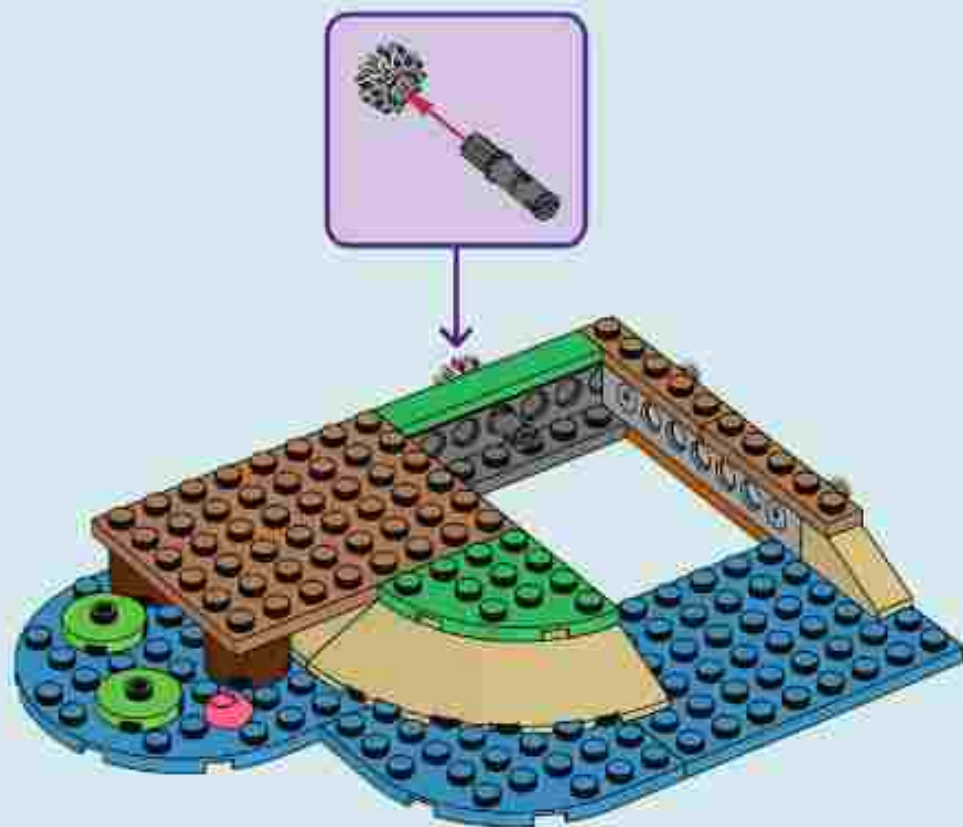



16

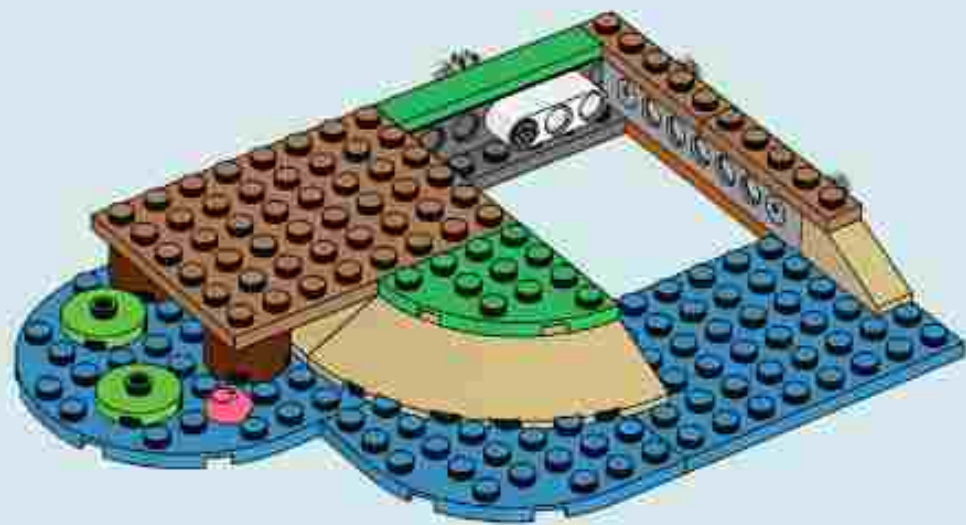



17

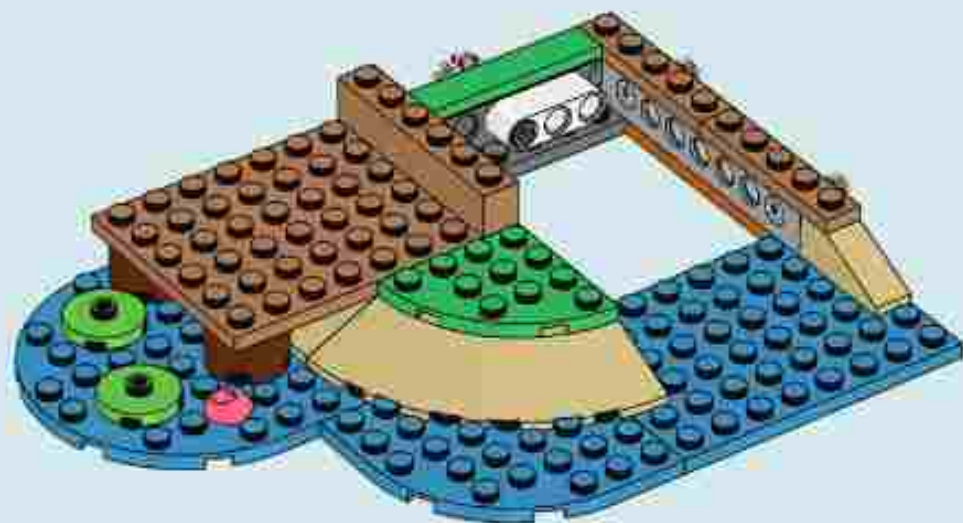



2x



1x

18

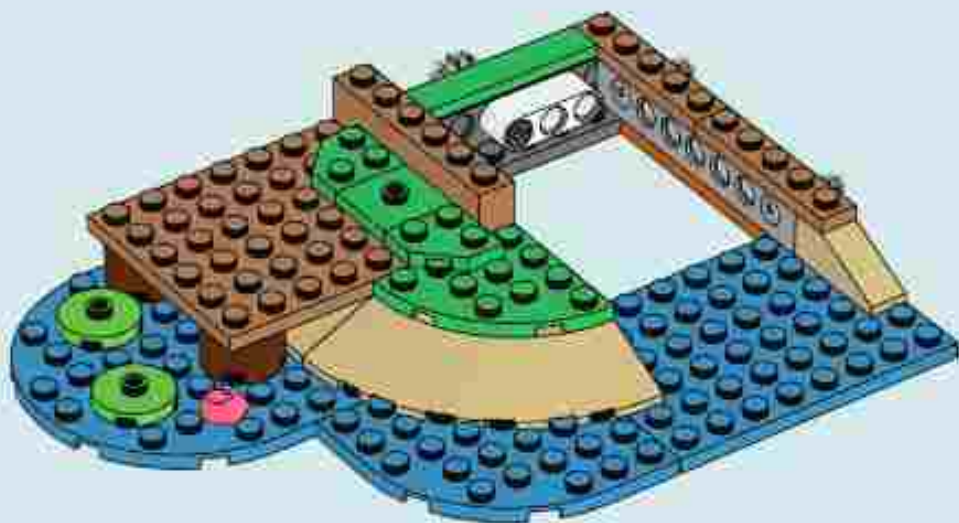





19

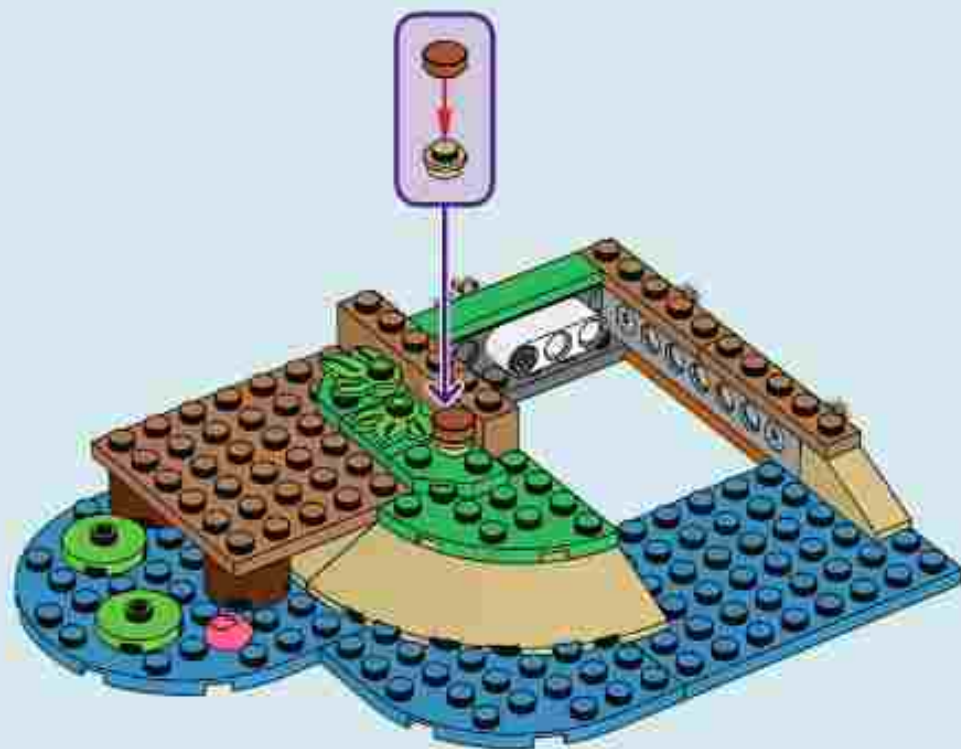



20

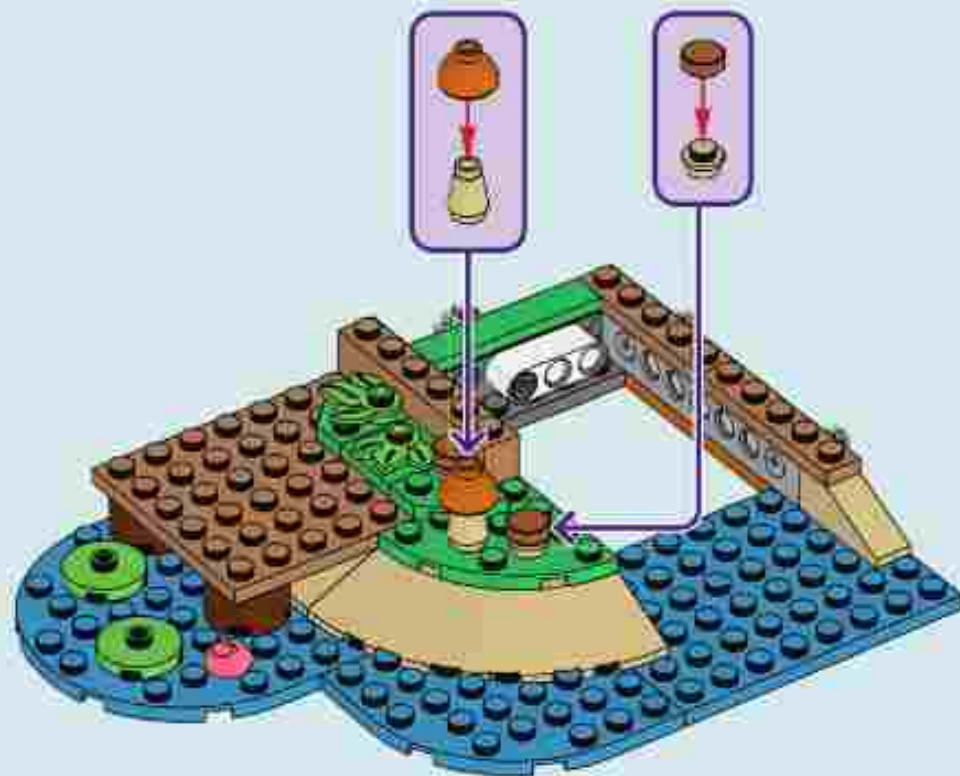



21

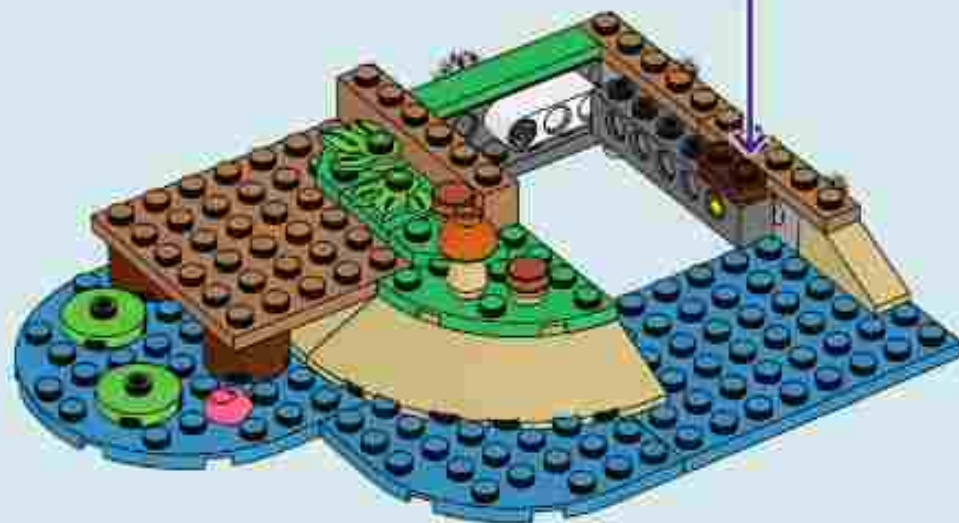



22

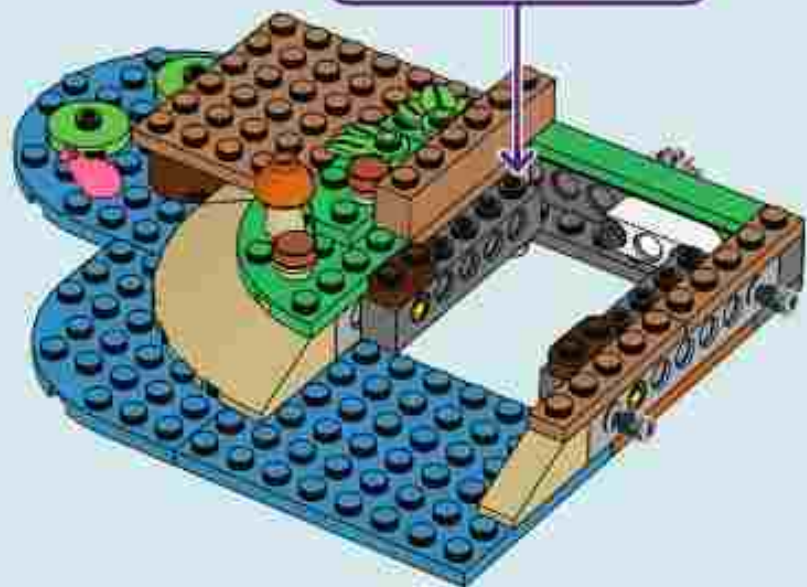
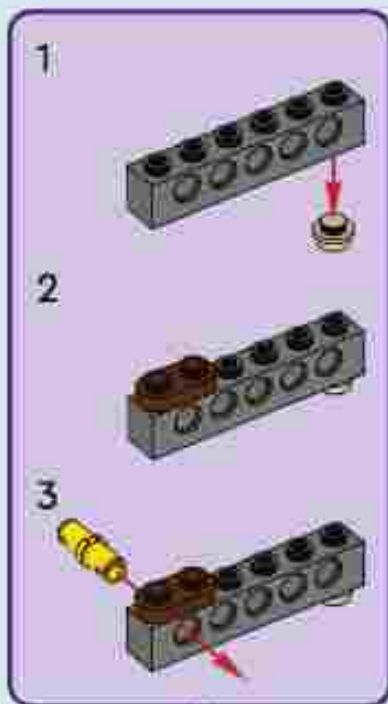

23

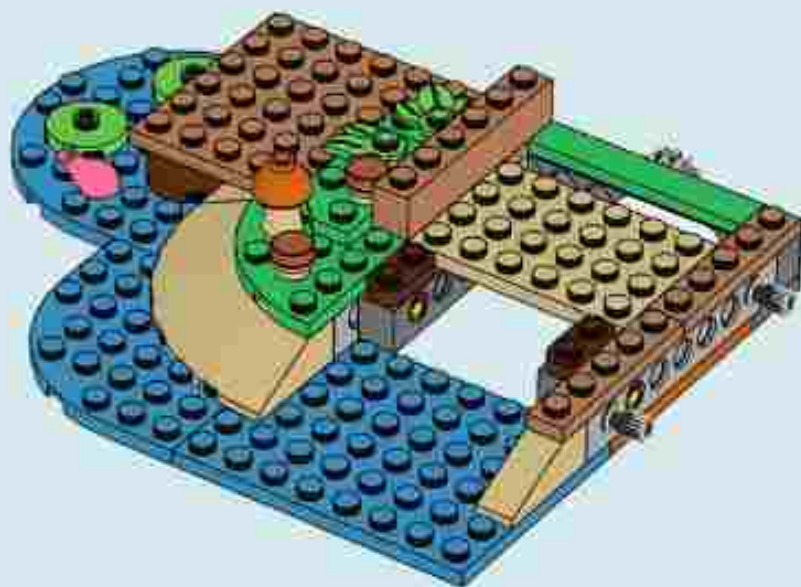





24

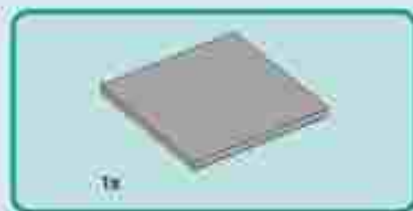

25





26

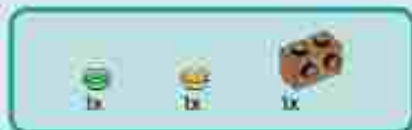
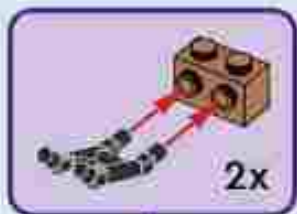

27

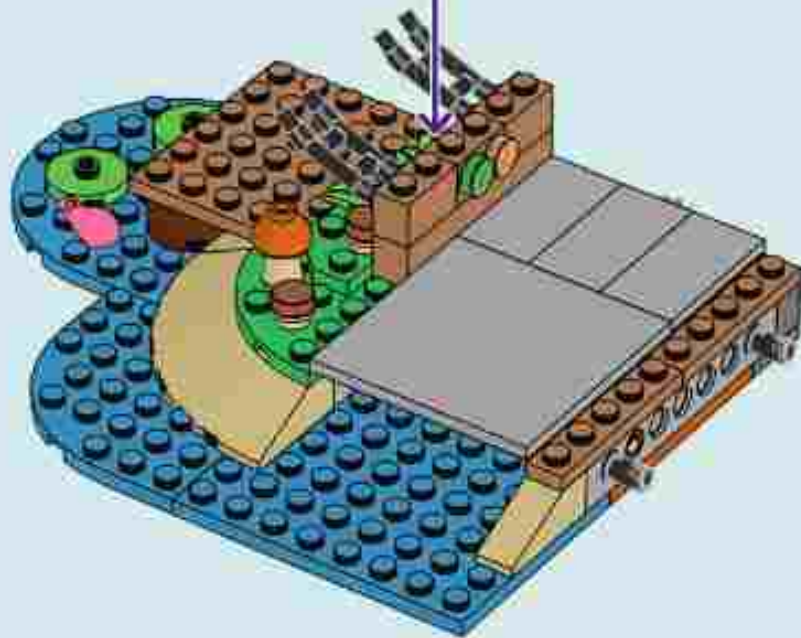

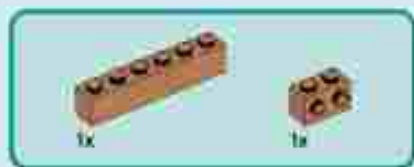

28

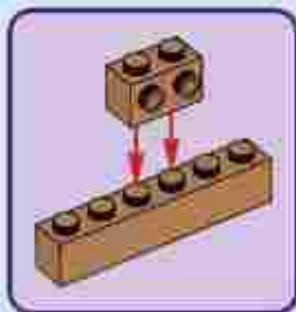

29

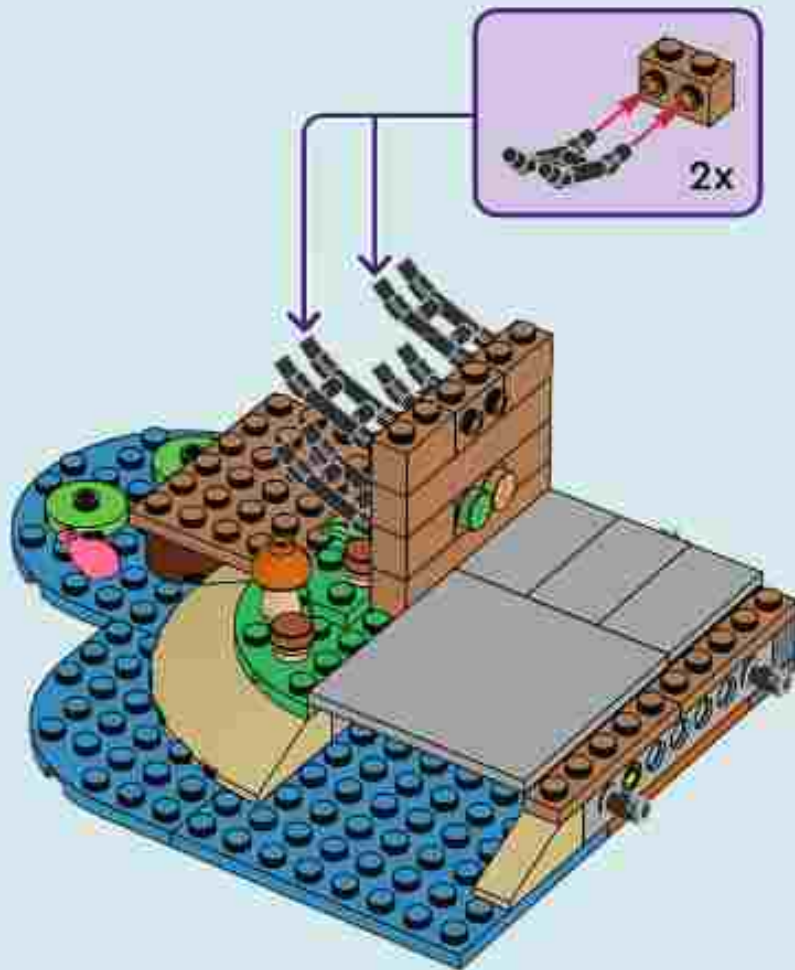





30

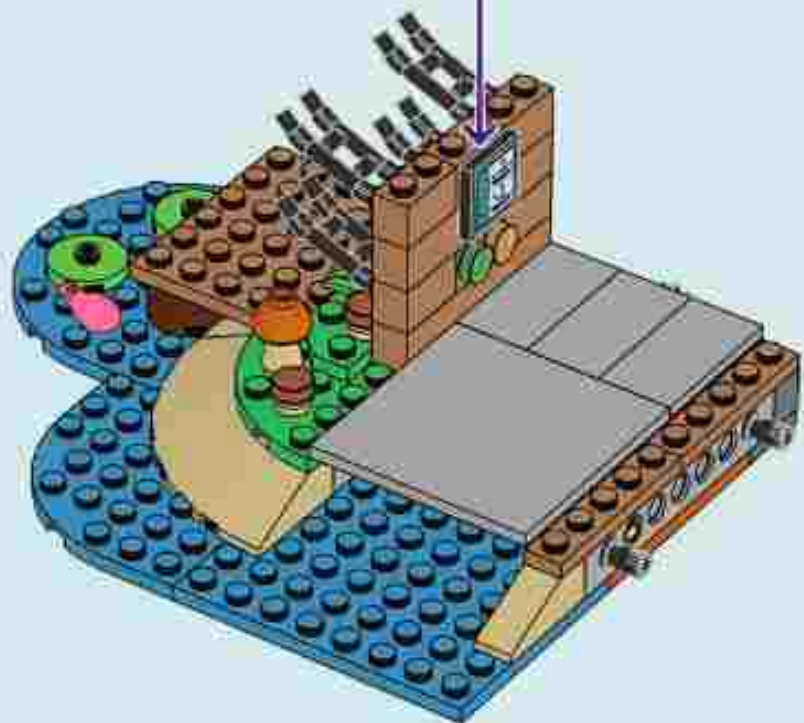

31

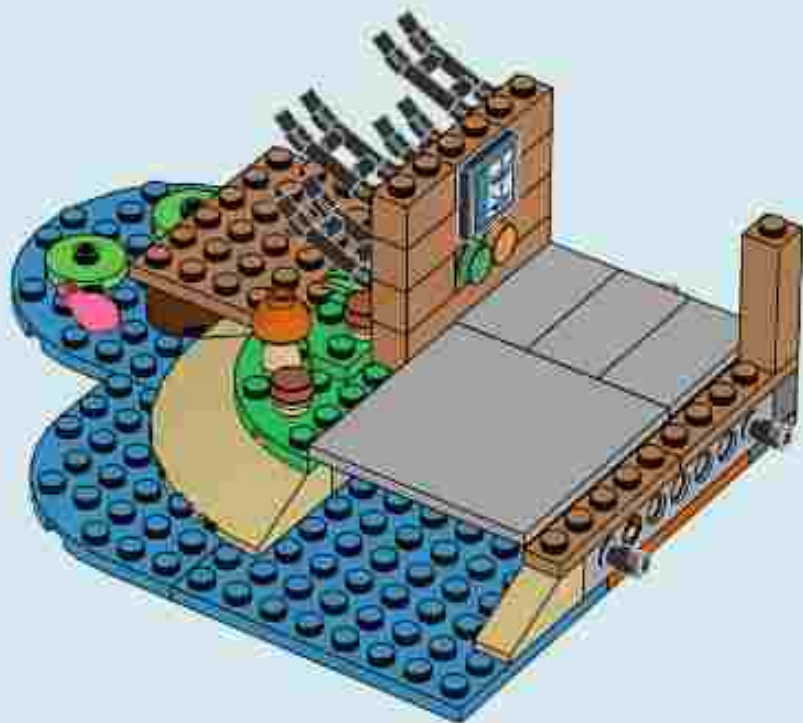



32

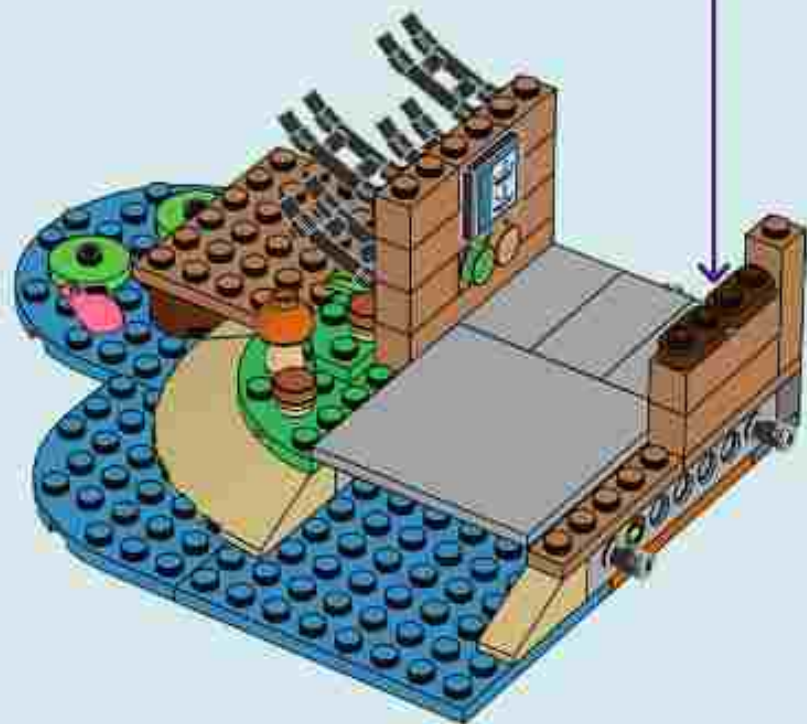
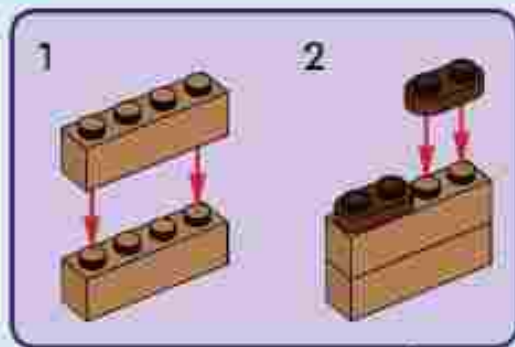

33

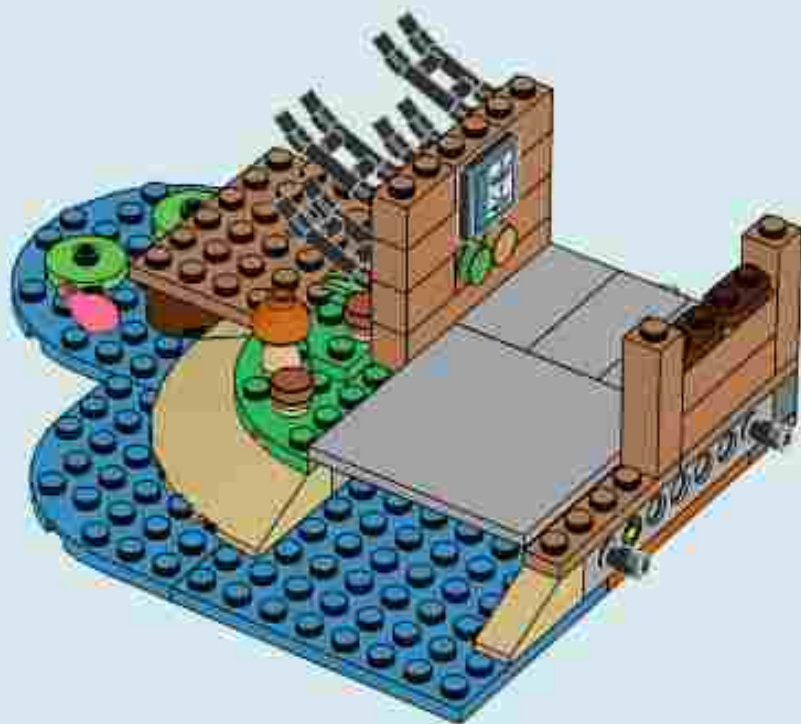





34

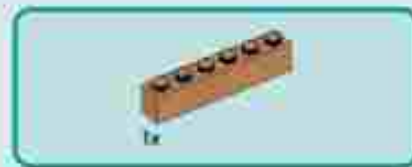
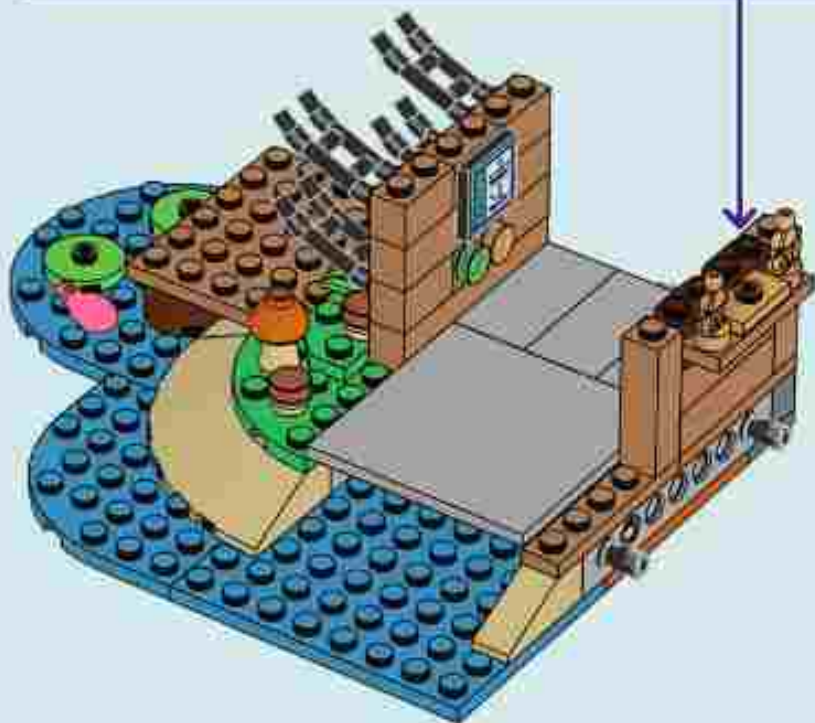

35

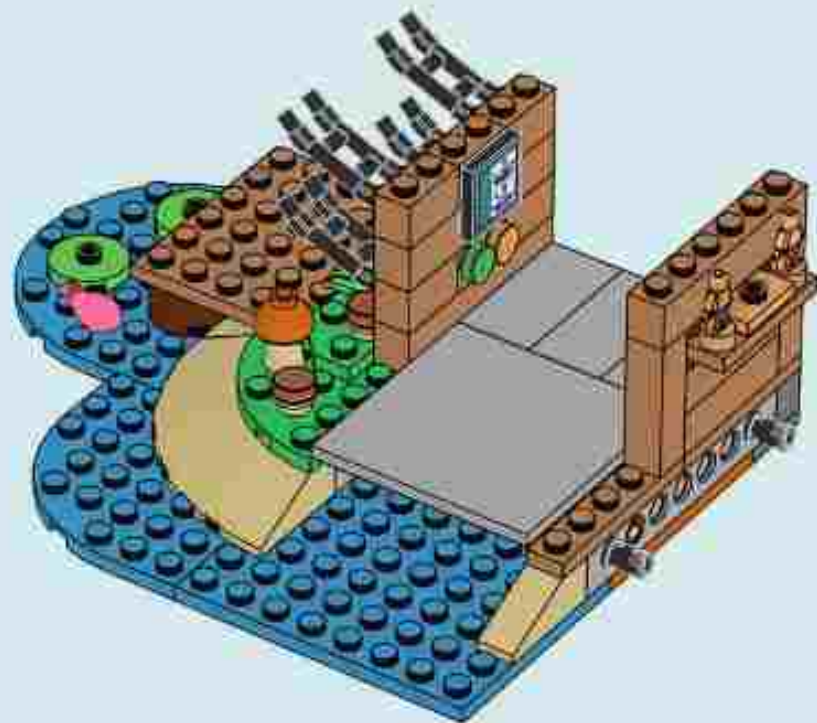

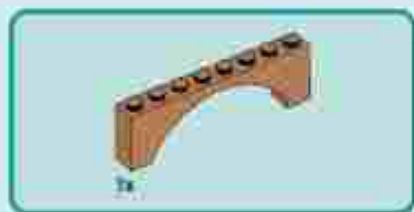

36

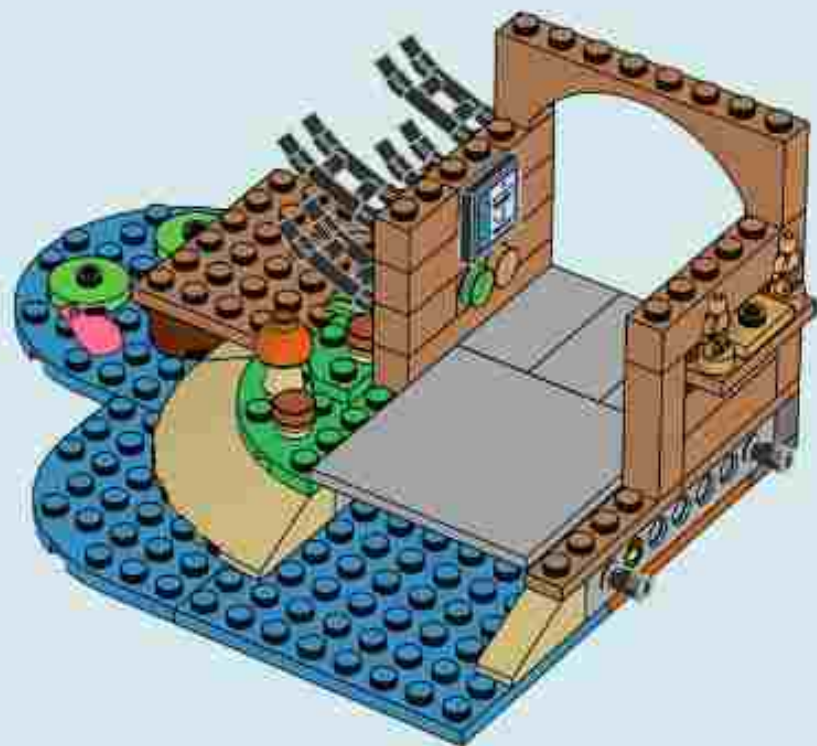

37

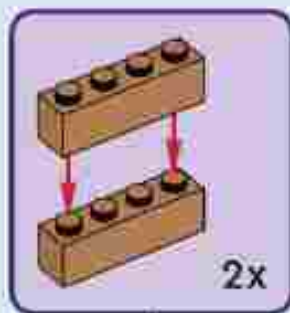
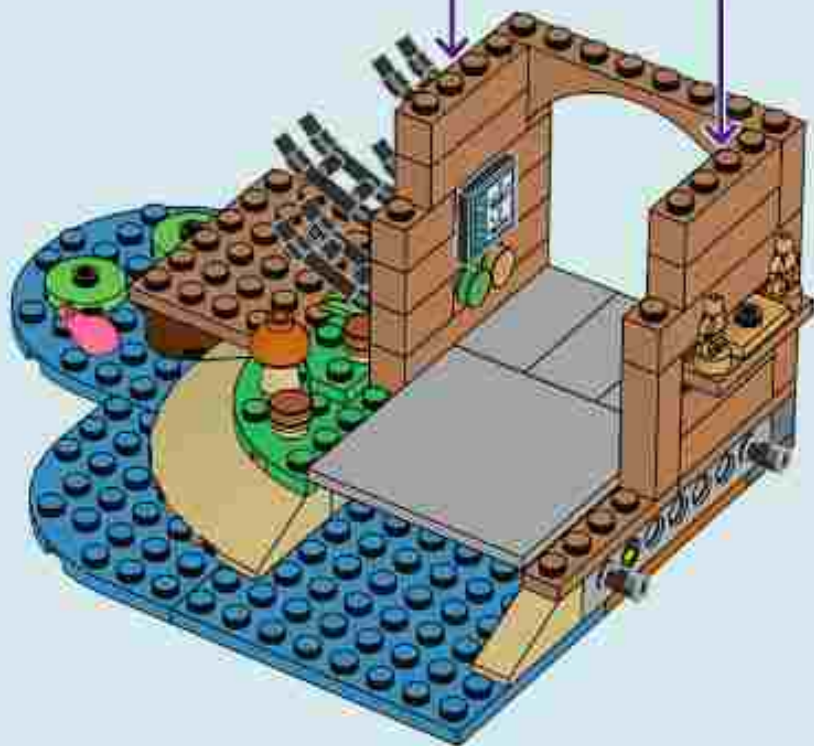



38

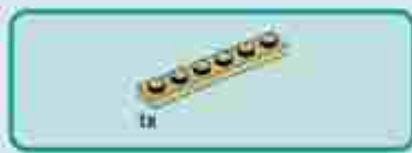
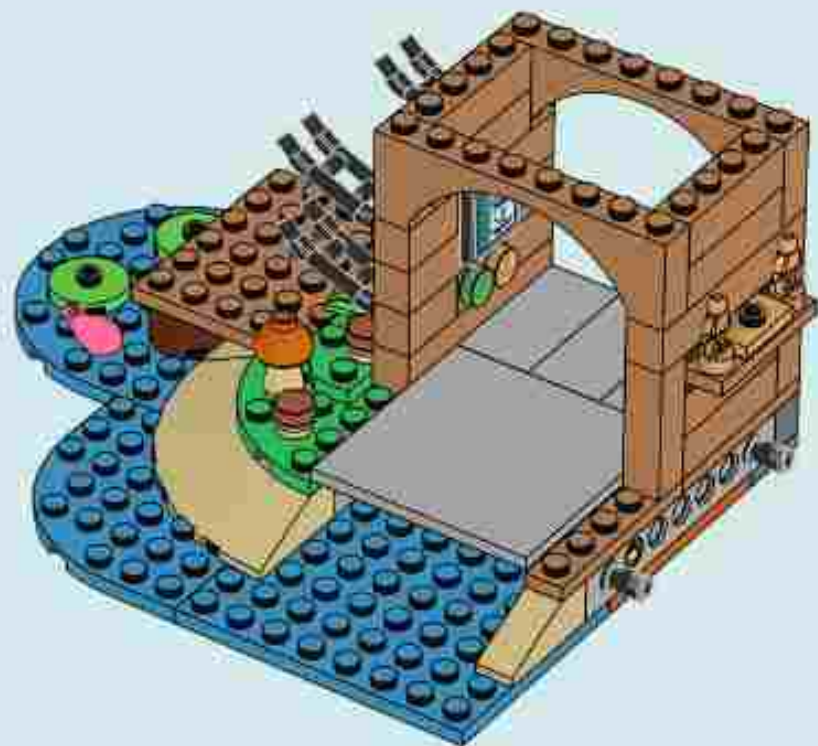

39

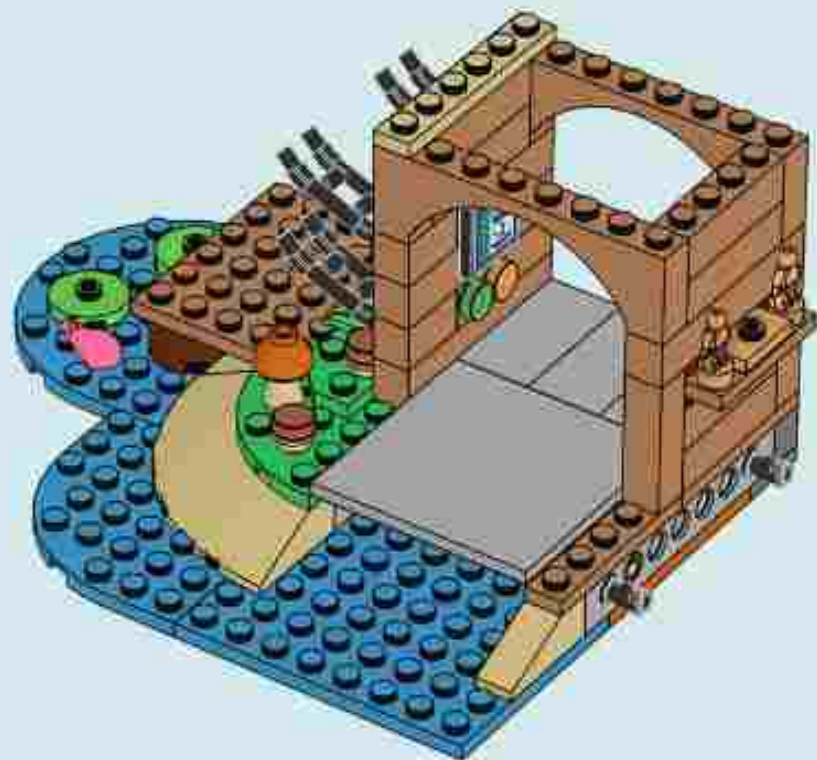





40

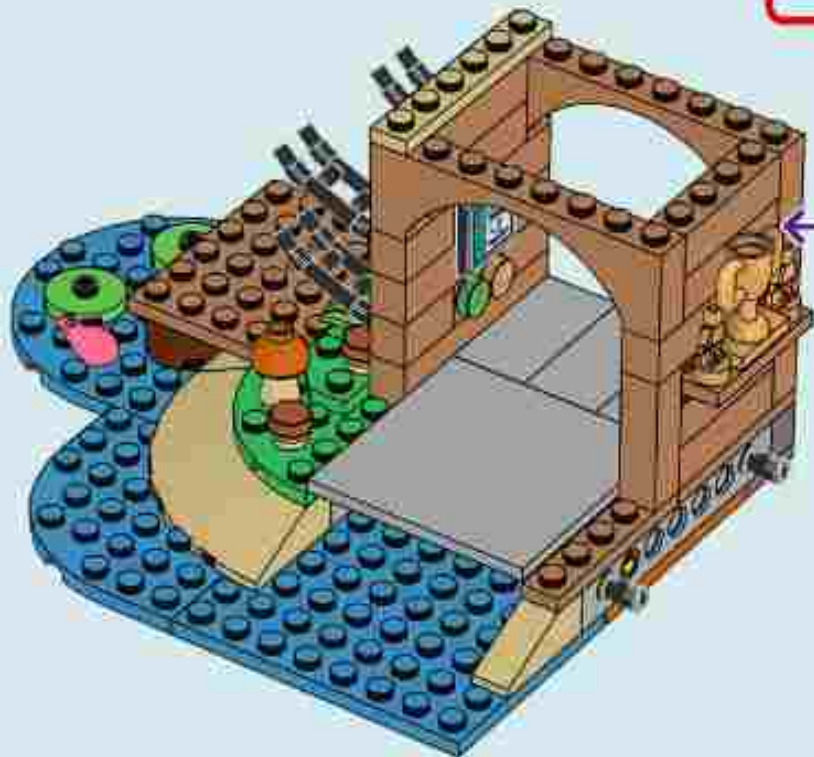
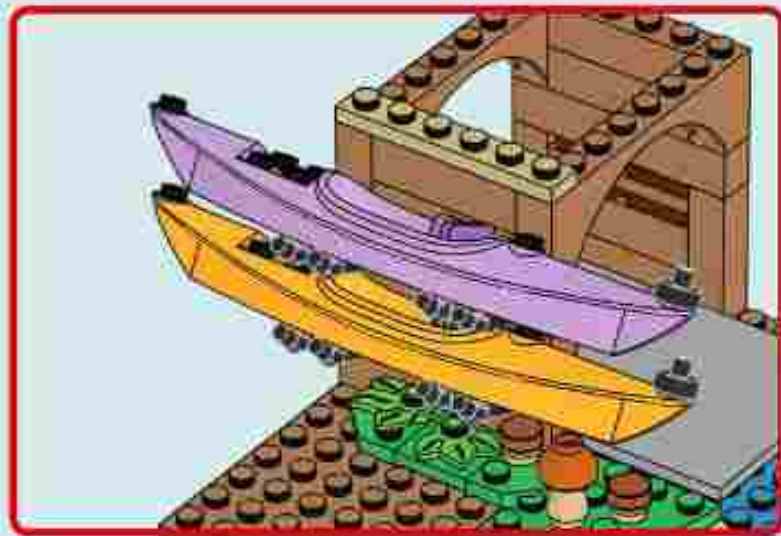



1



2

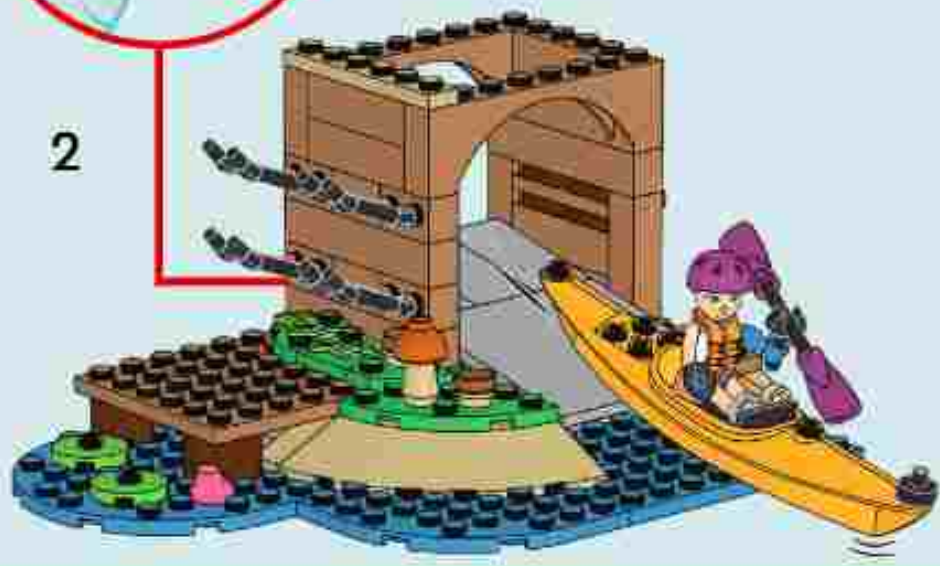



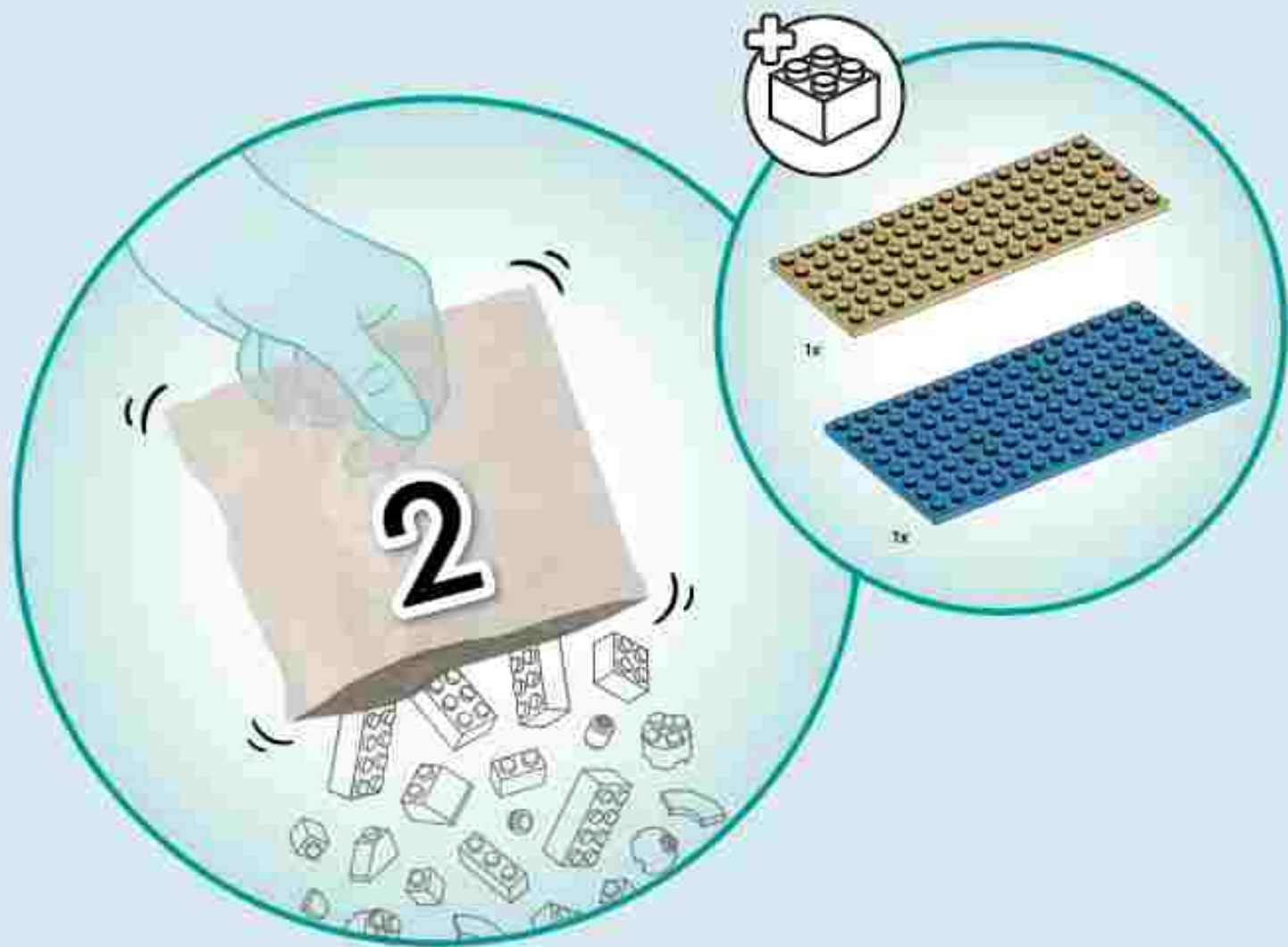

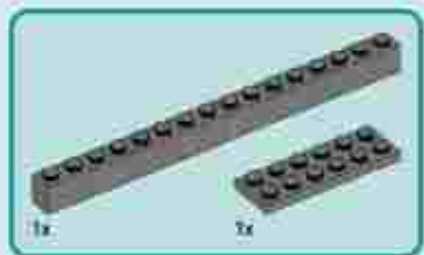

41

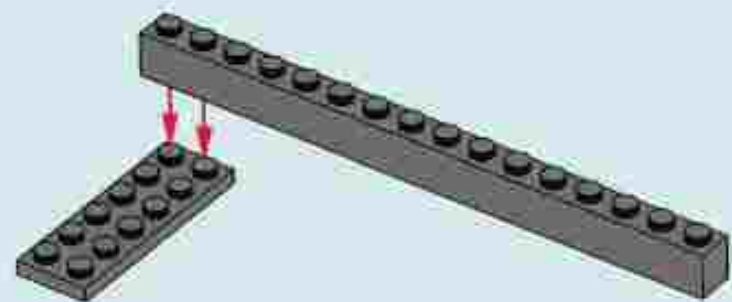

42

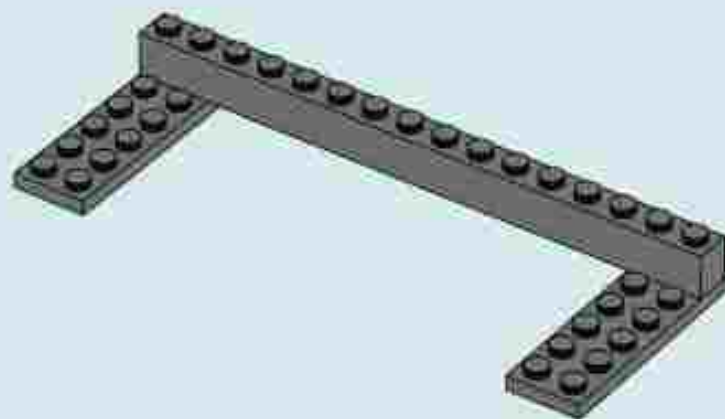

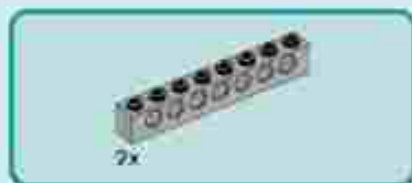

43

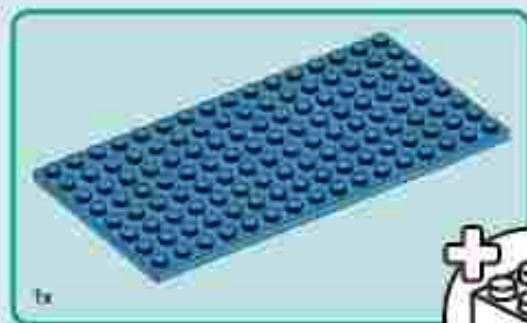
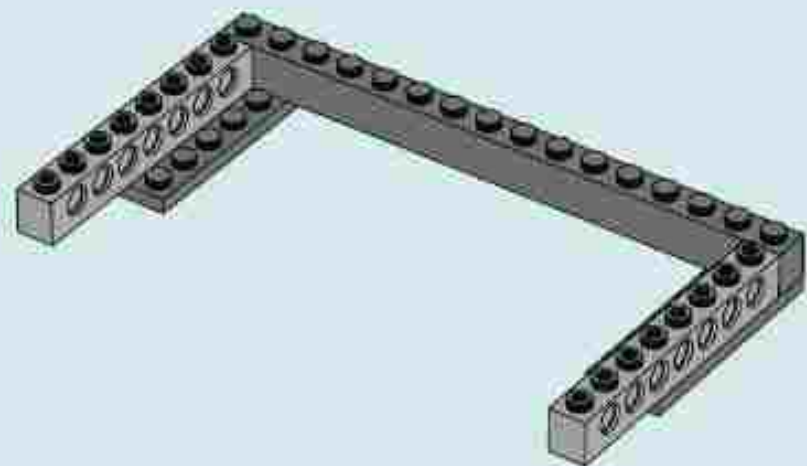

44

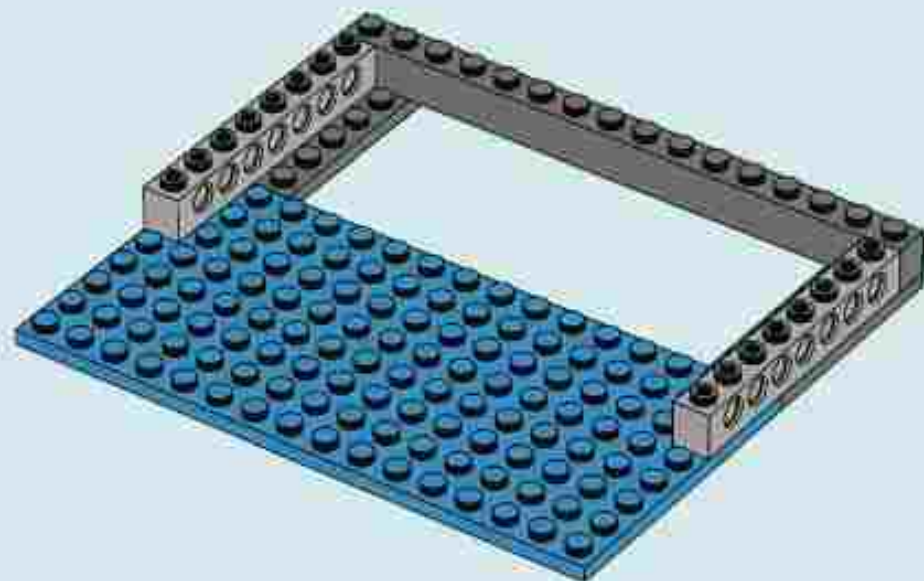



45

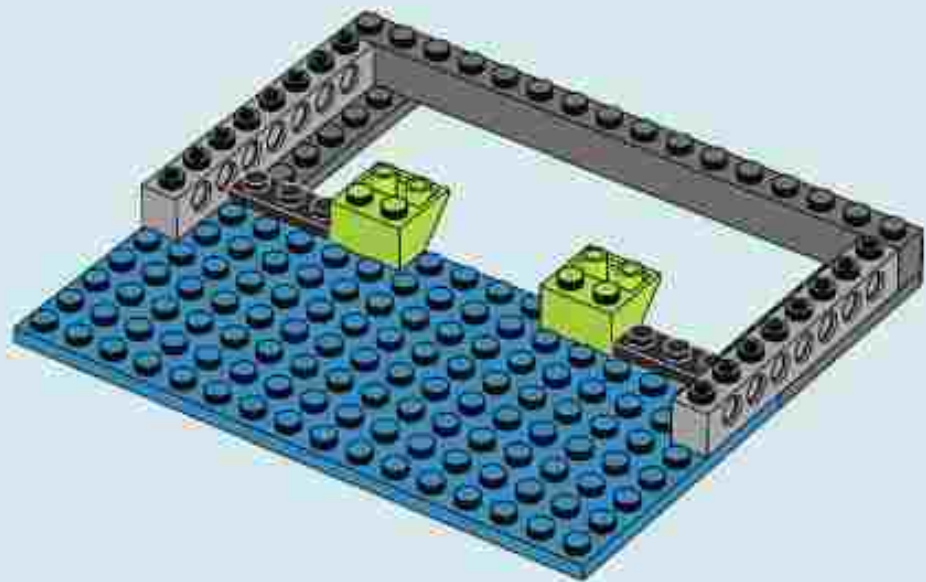

46

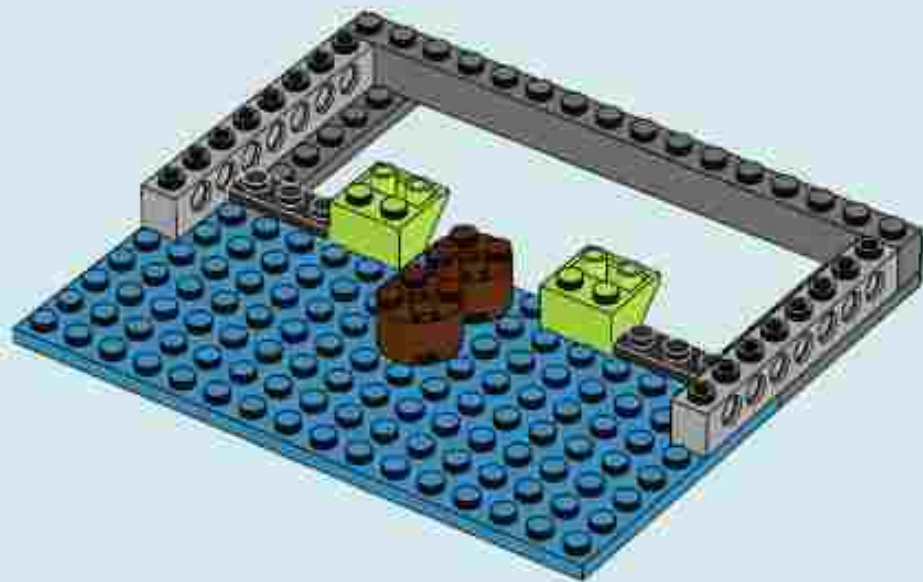



47

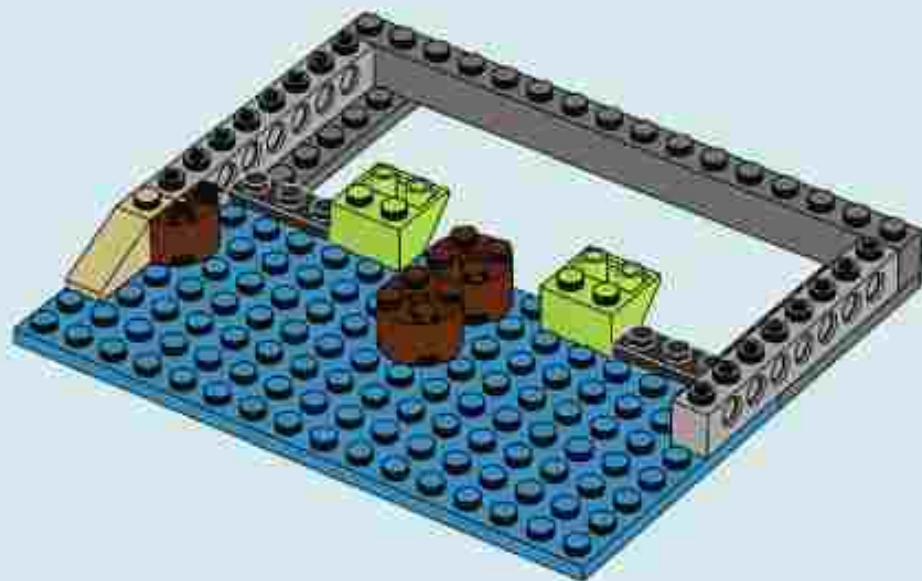

48

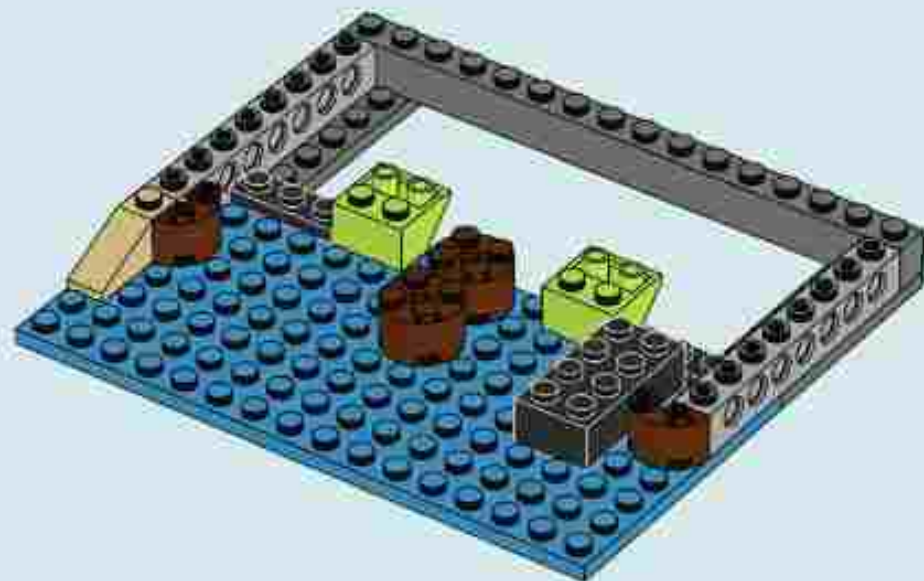



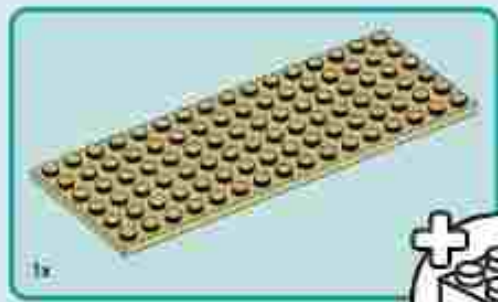

49



50

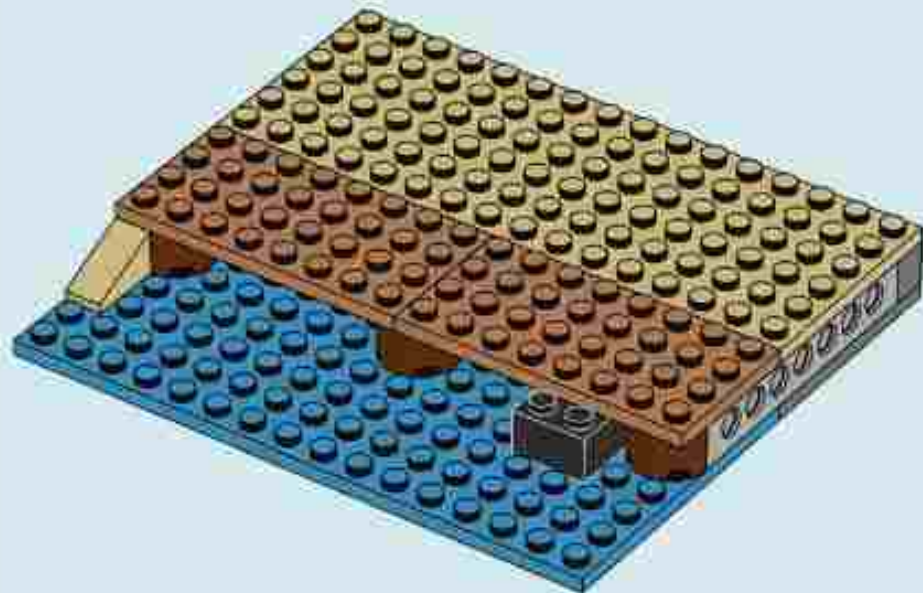
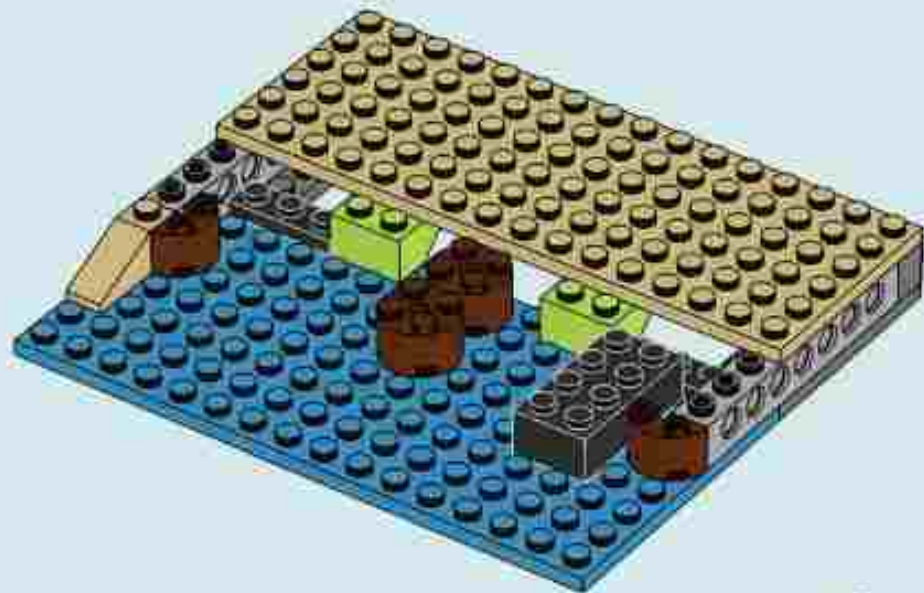



51

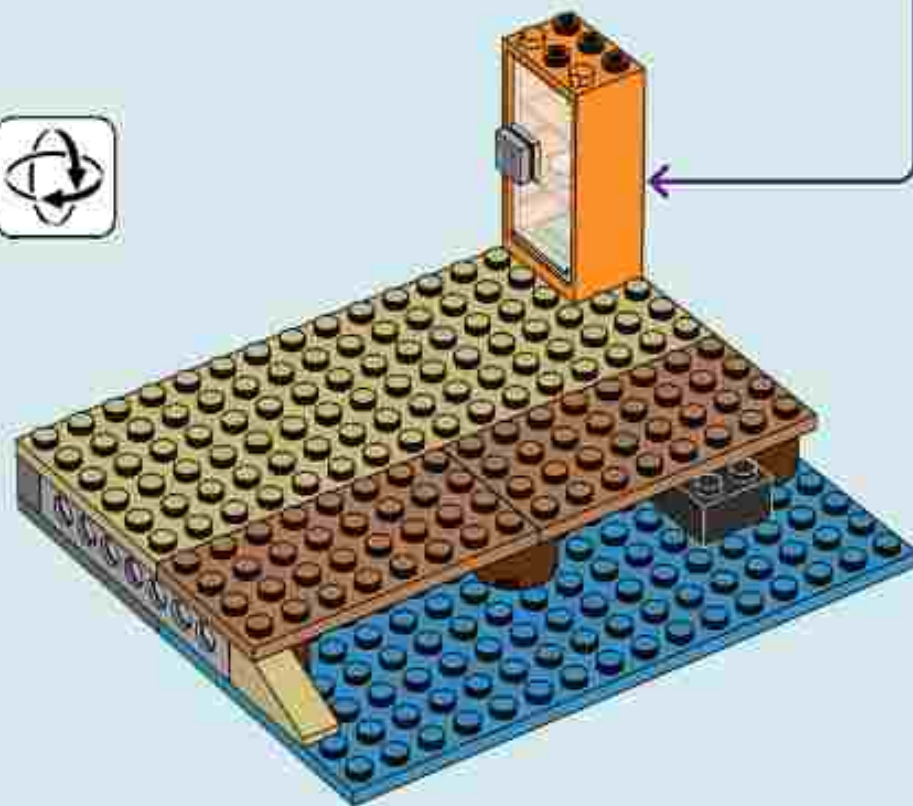
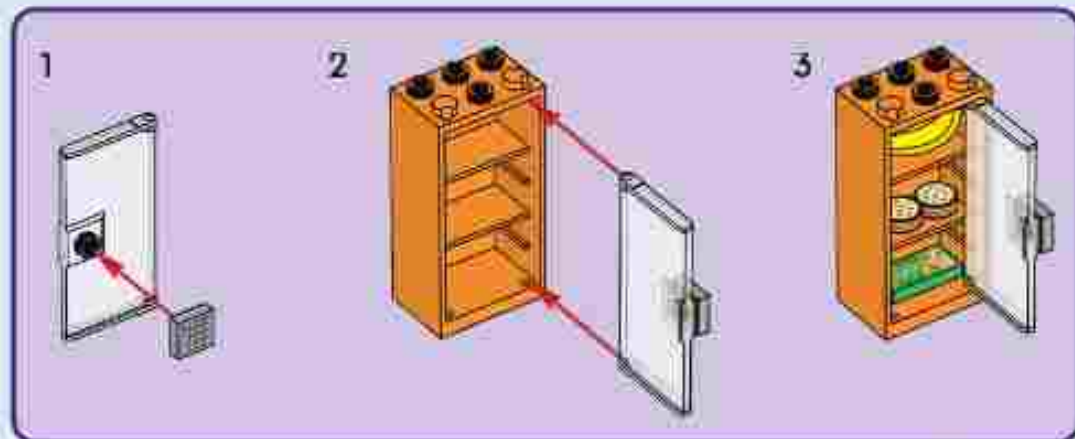



52

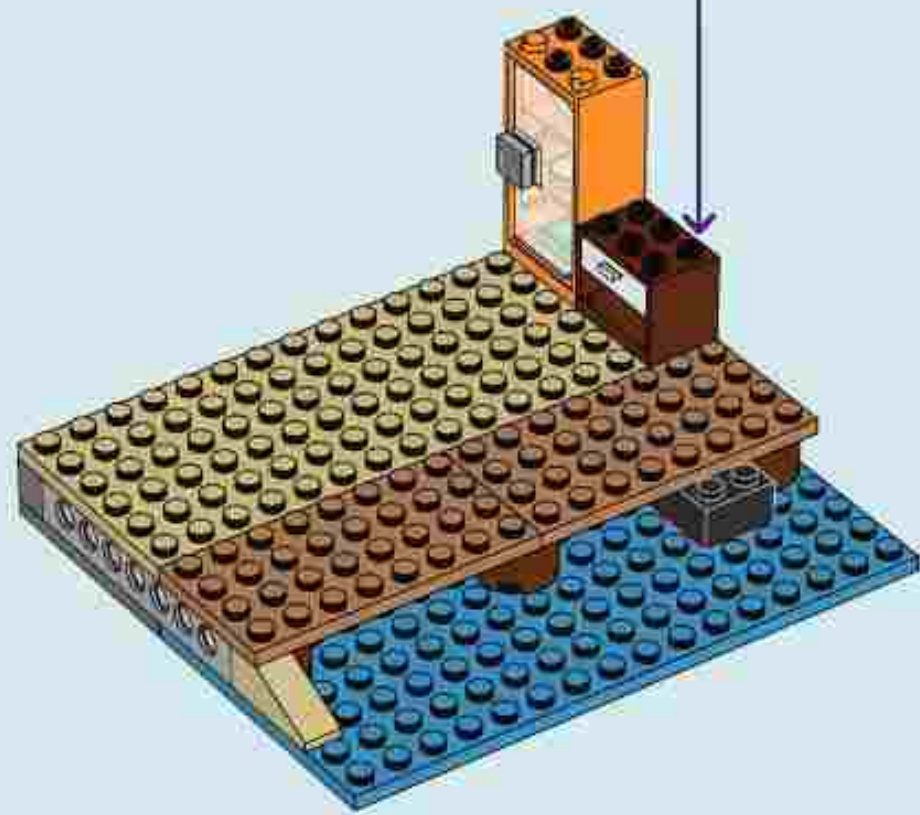
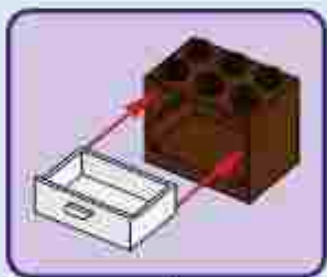

53

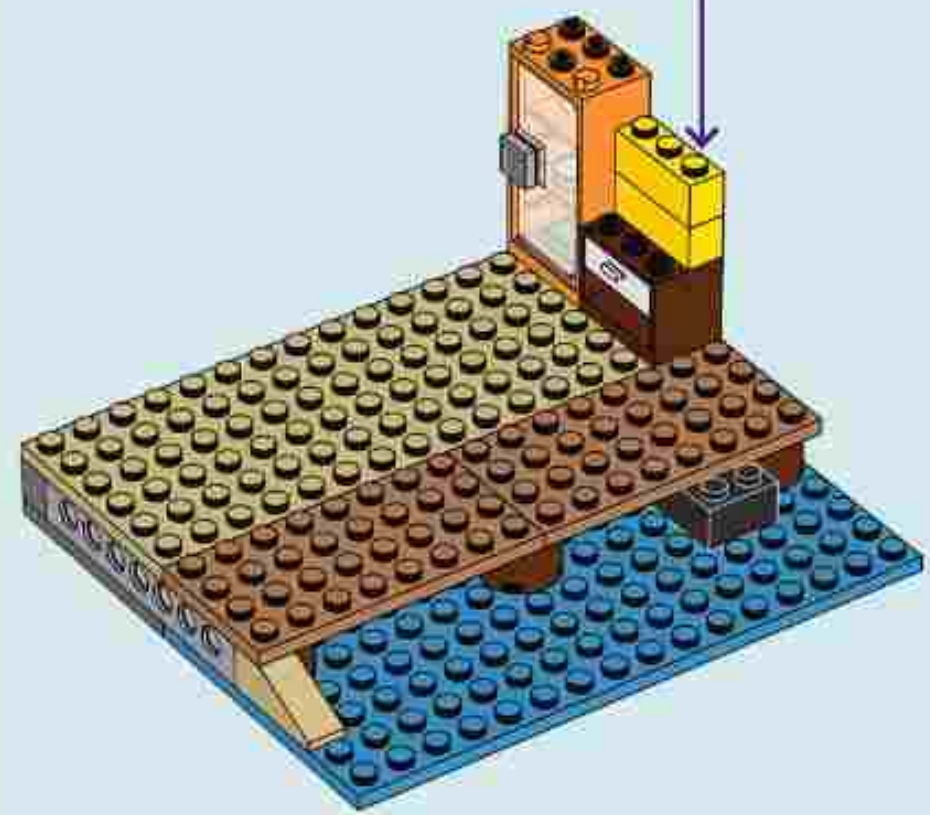
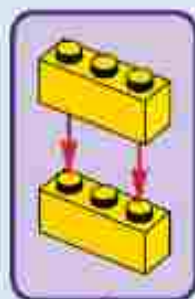





54

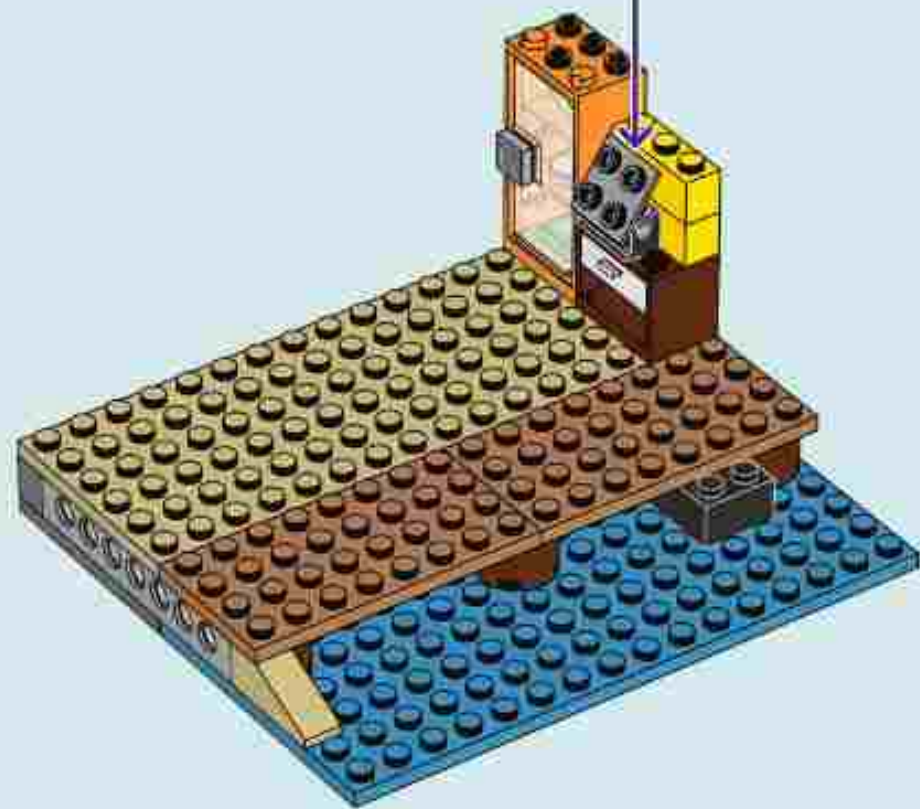

55

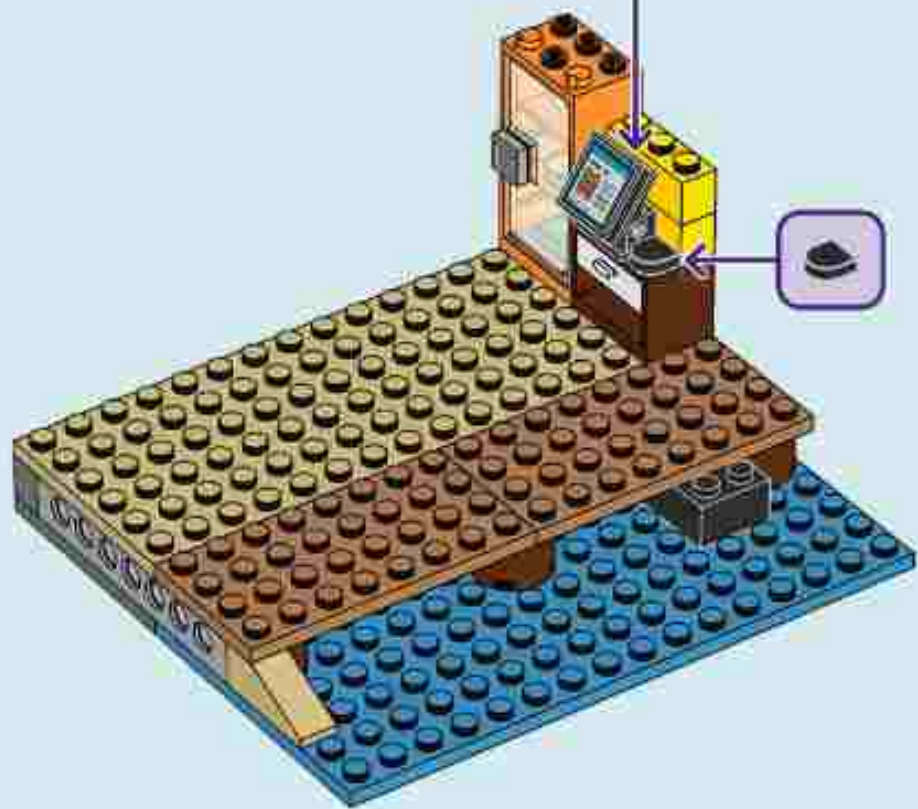



56

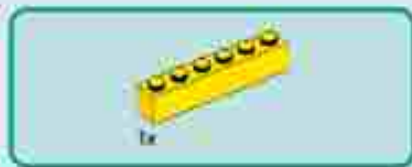
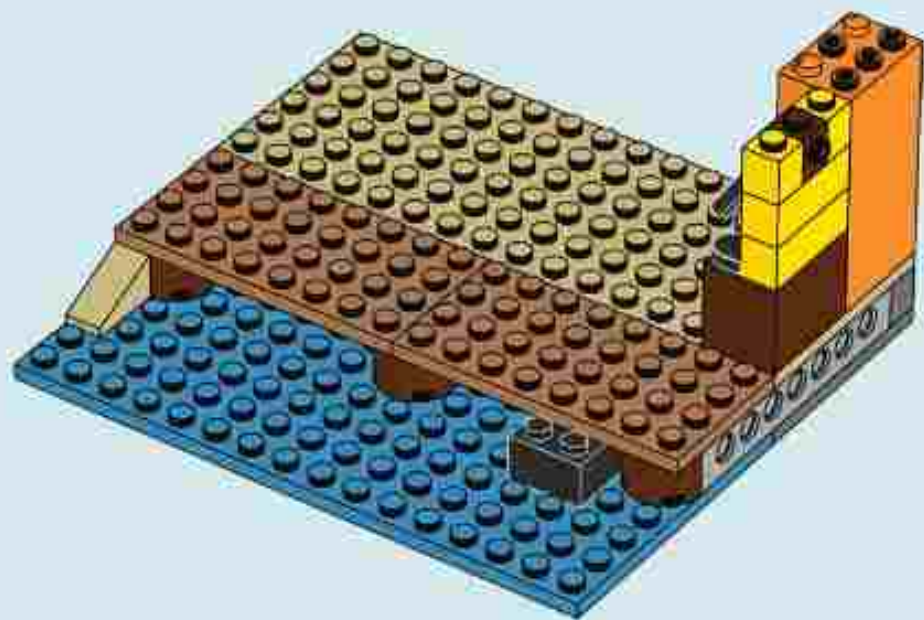

57

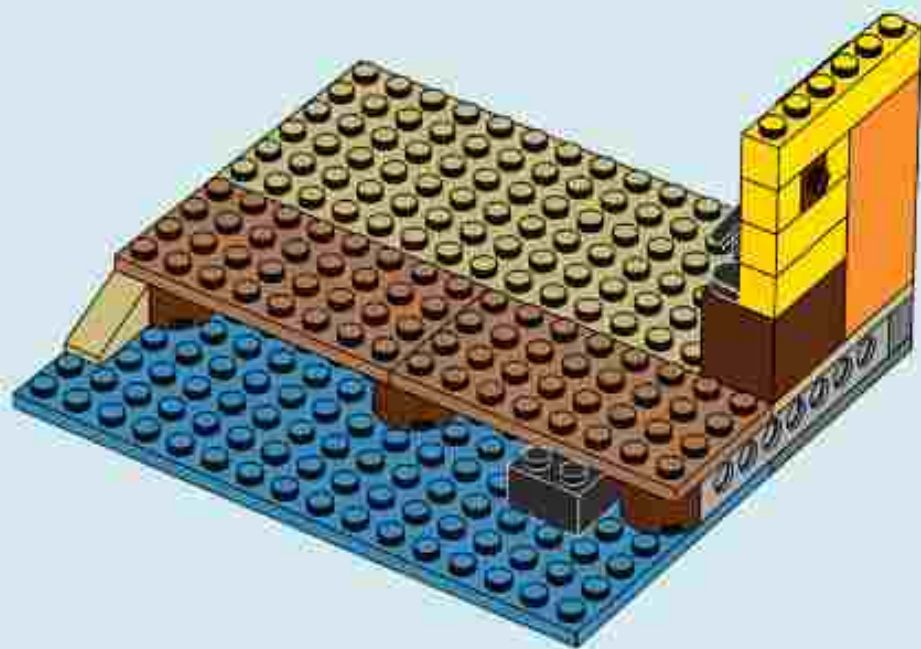





58

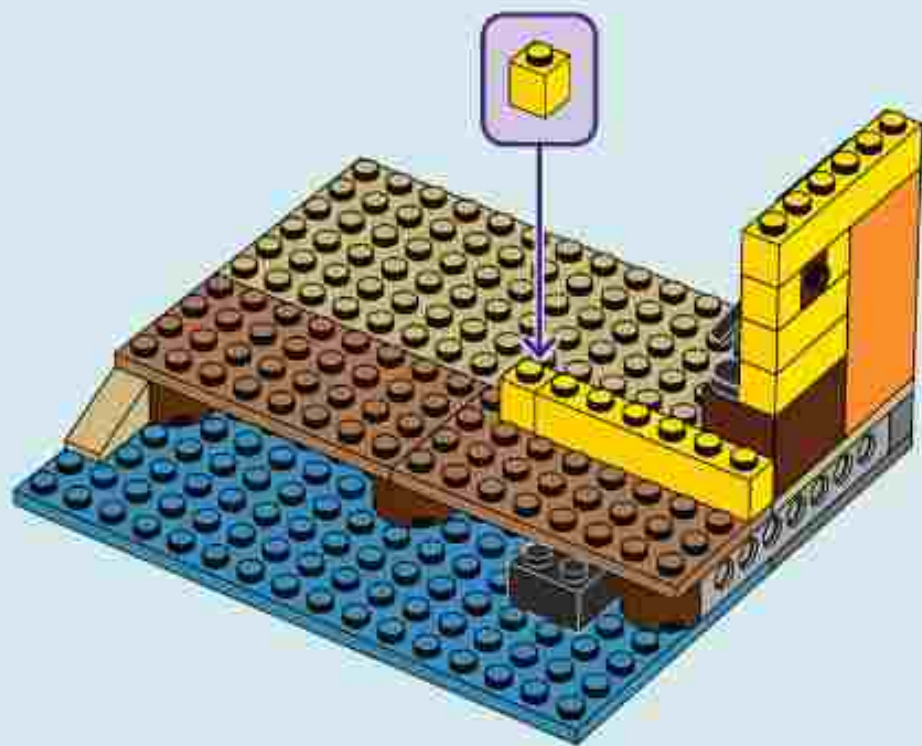

59

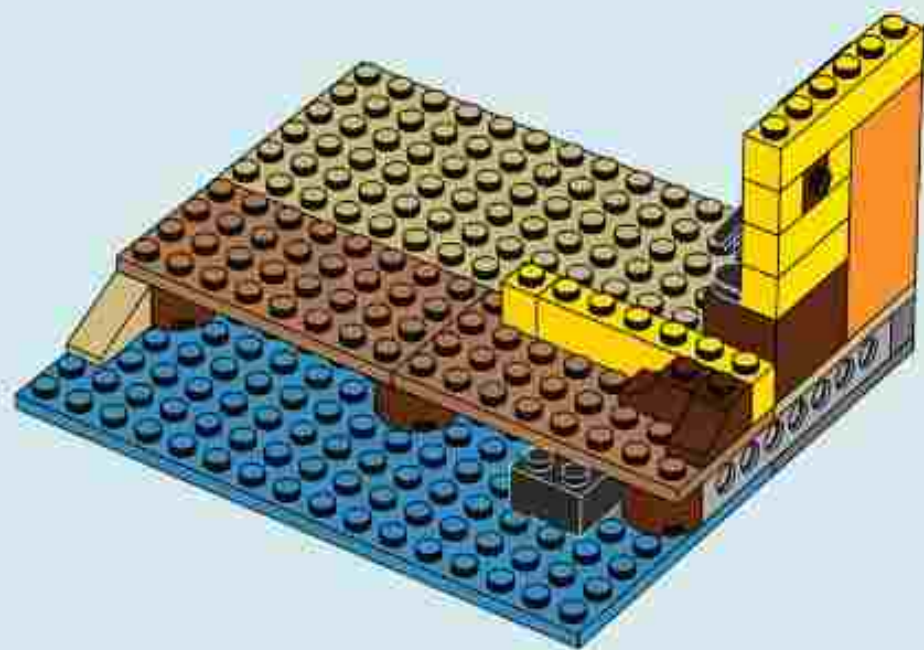



60

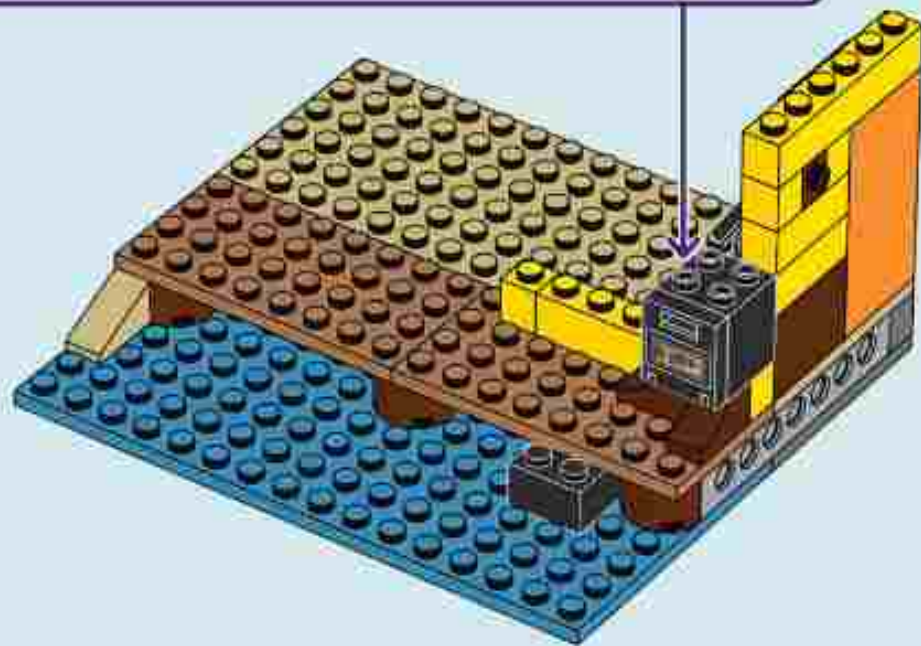
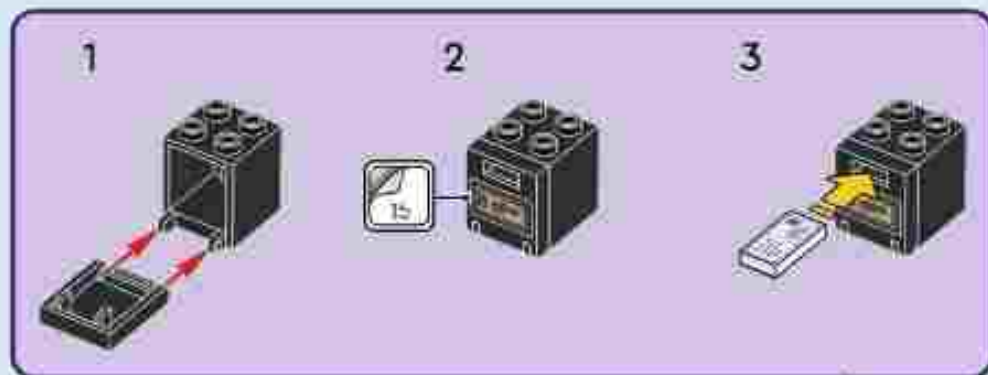



61

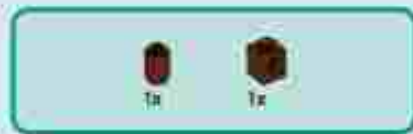
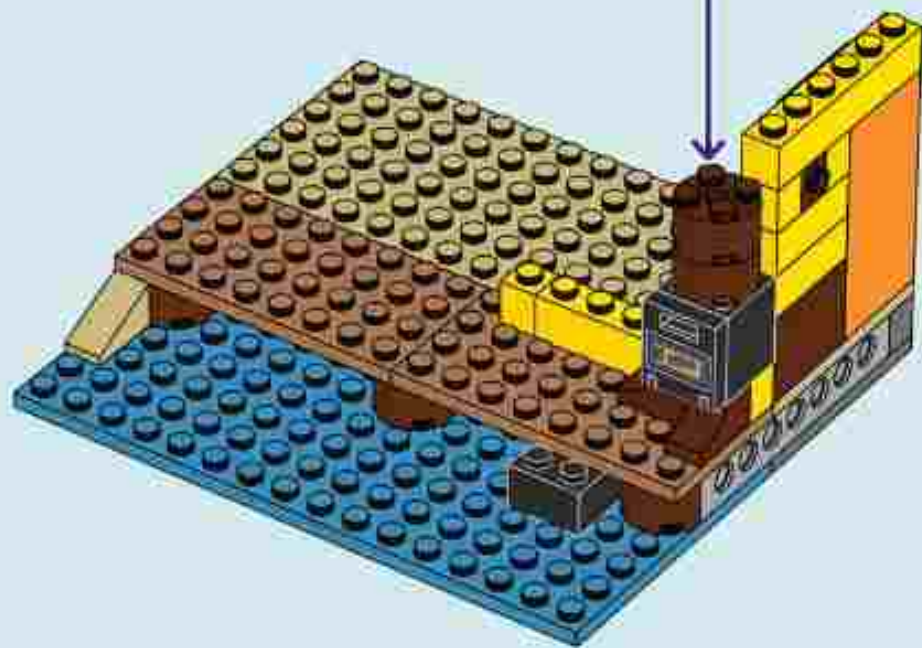

62

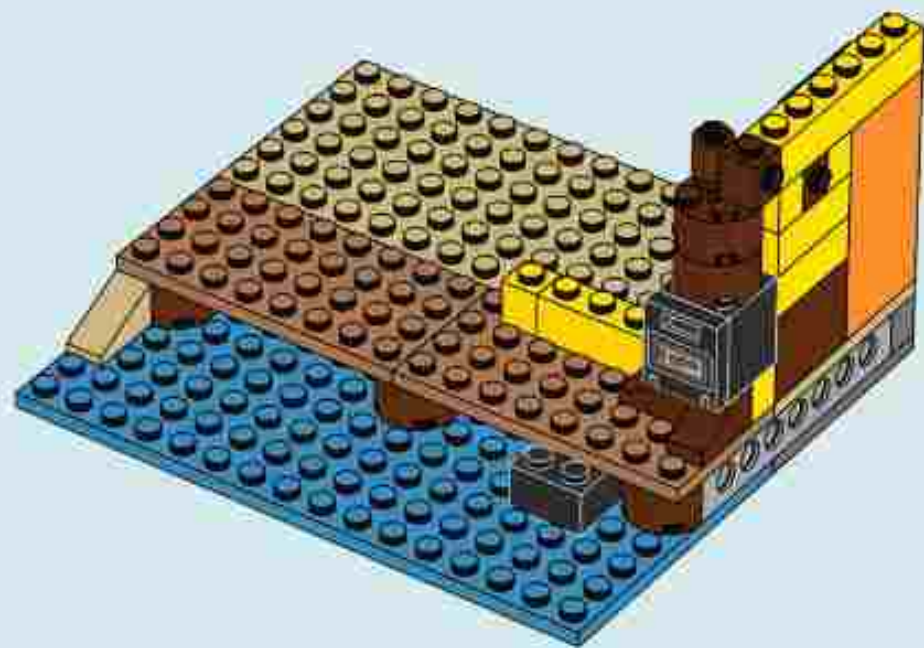





1x

63

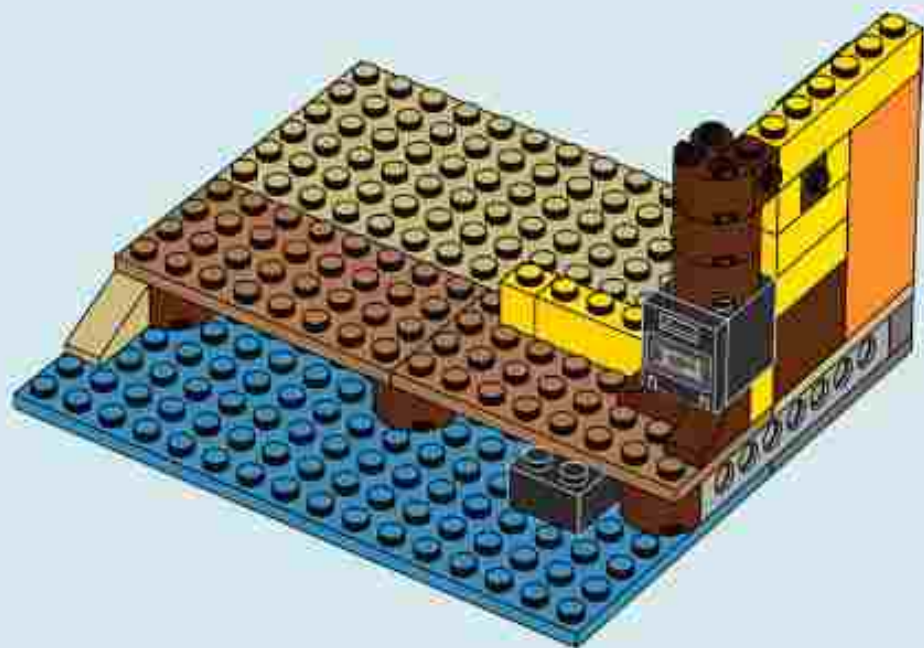

1x



1x



1x

64

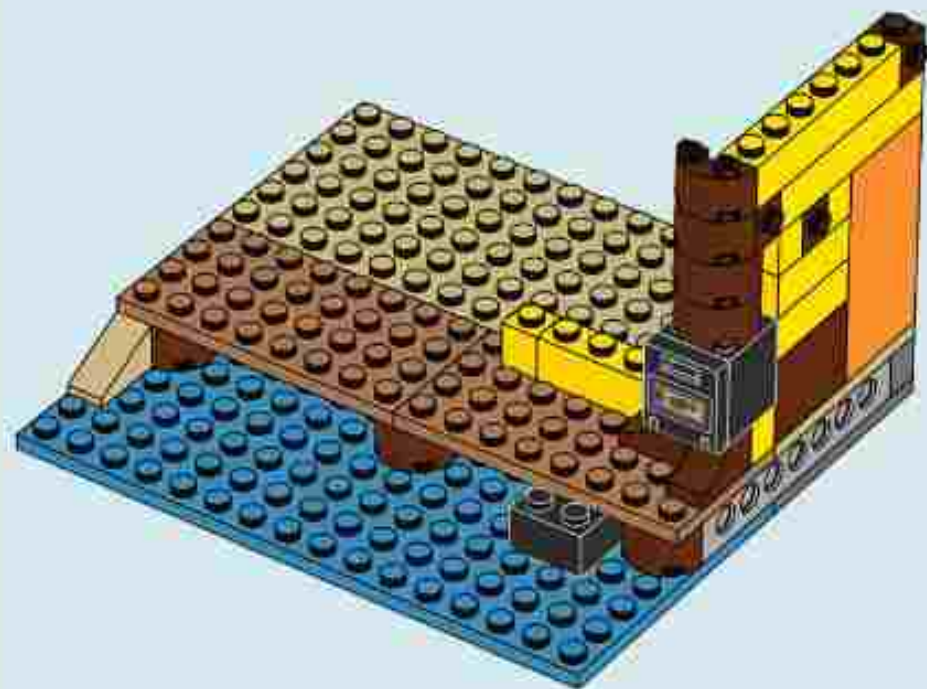





65

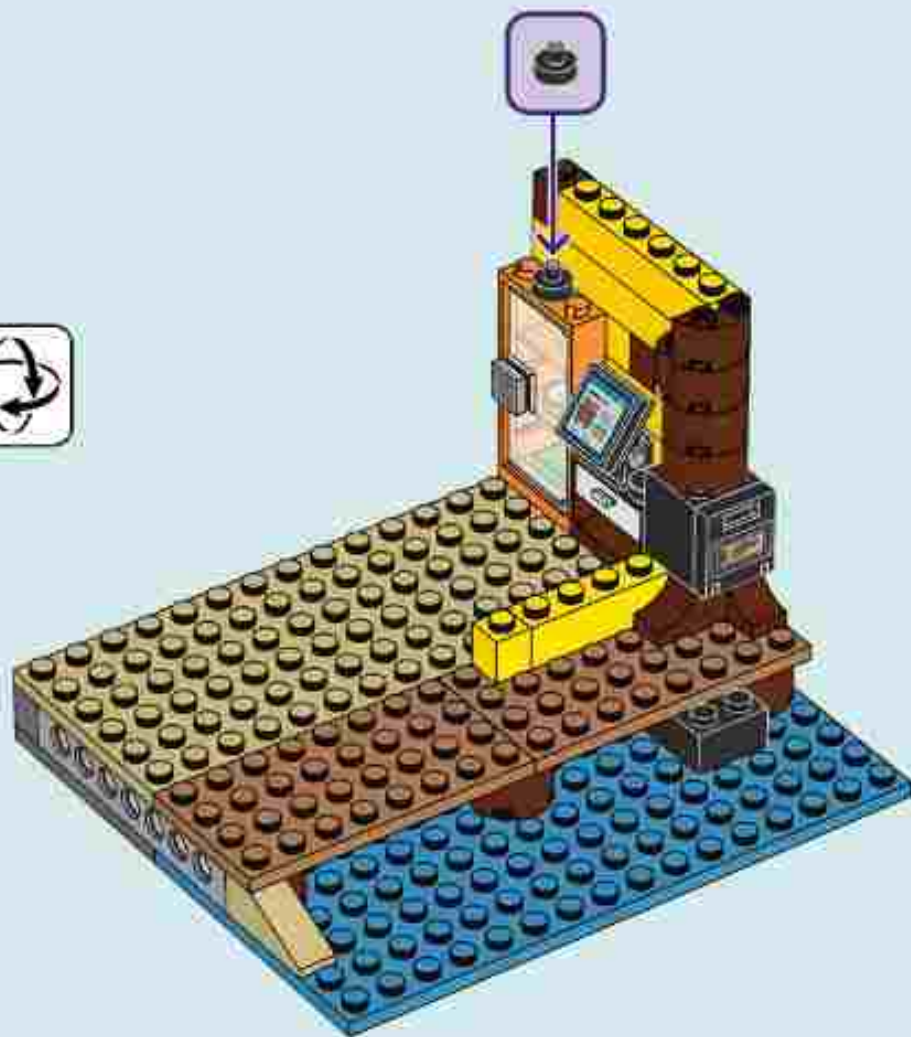



66

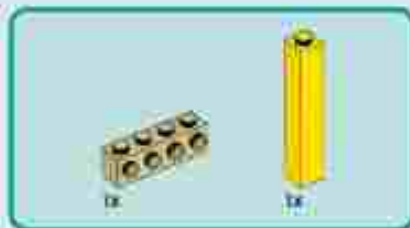
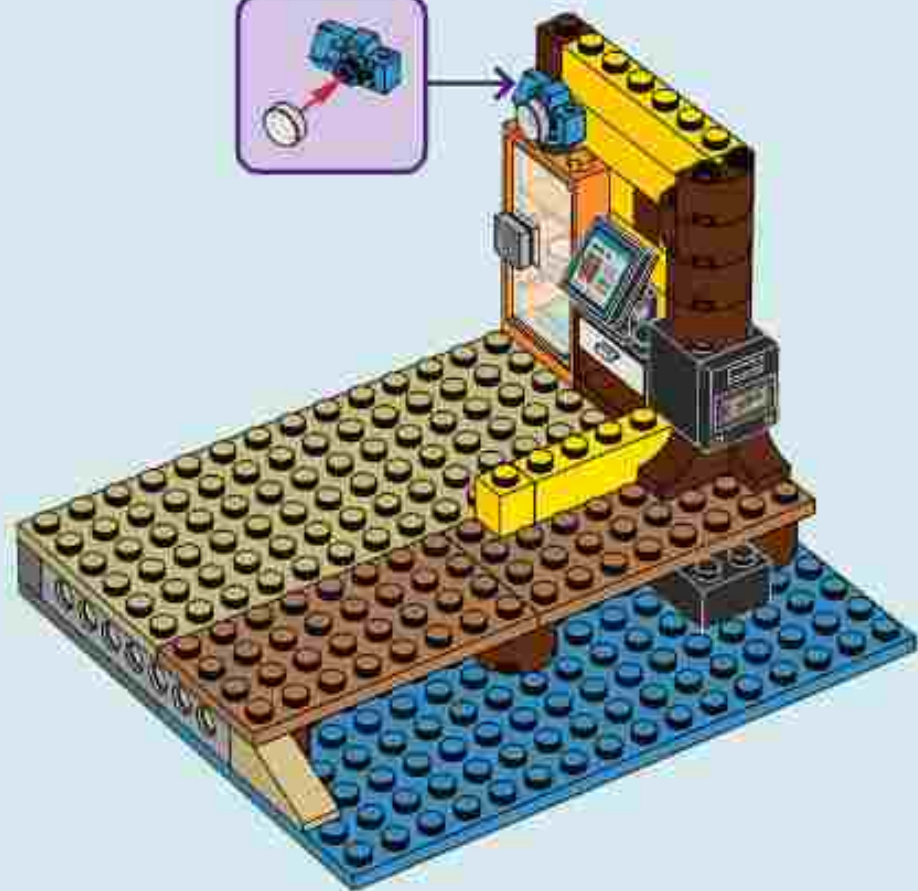

67

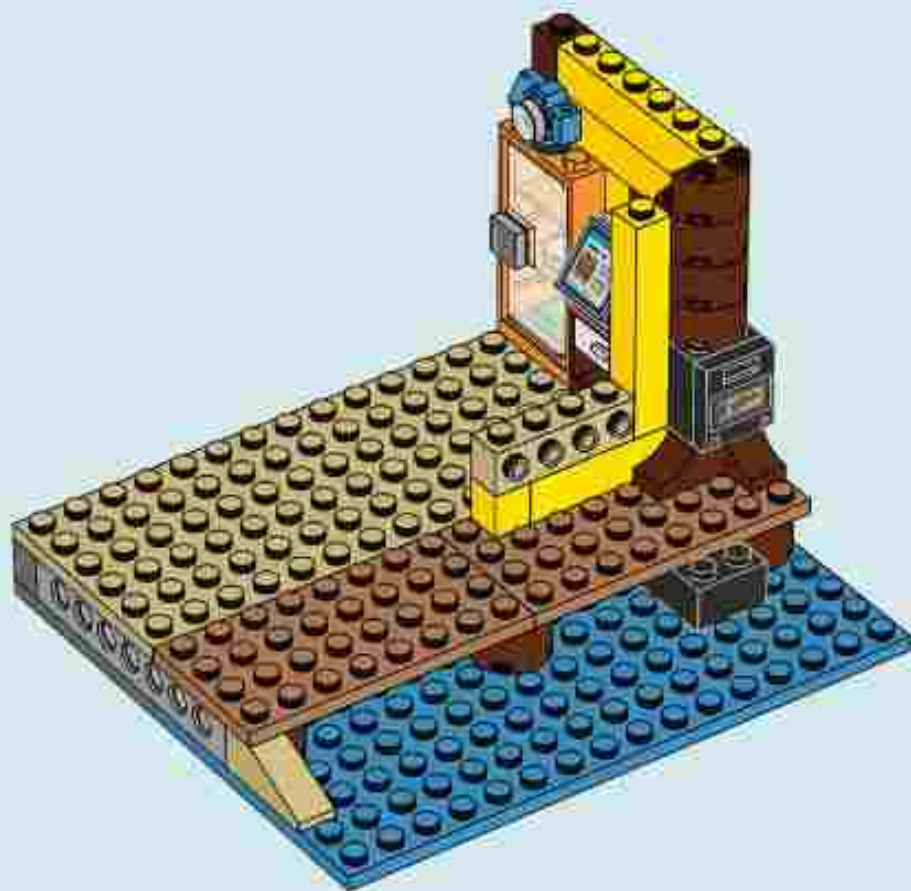



68

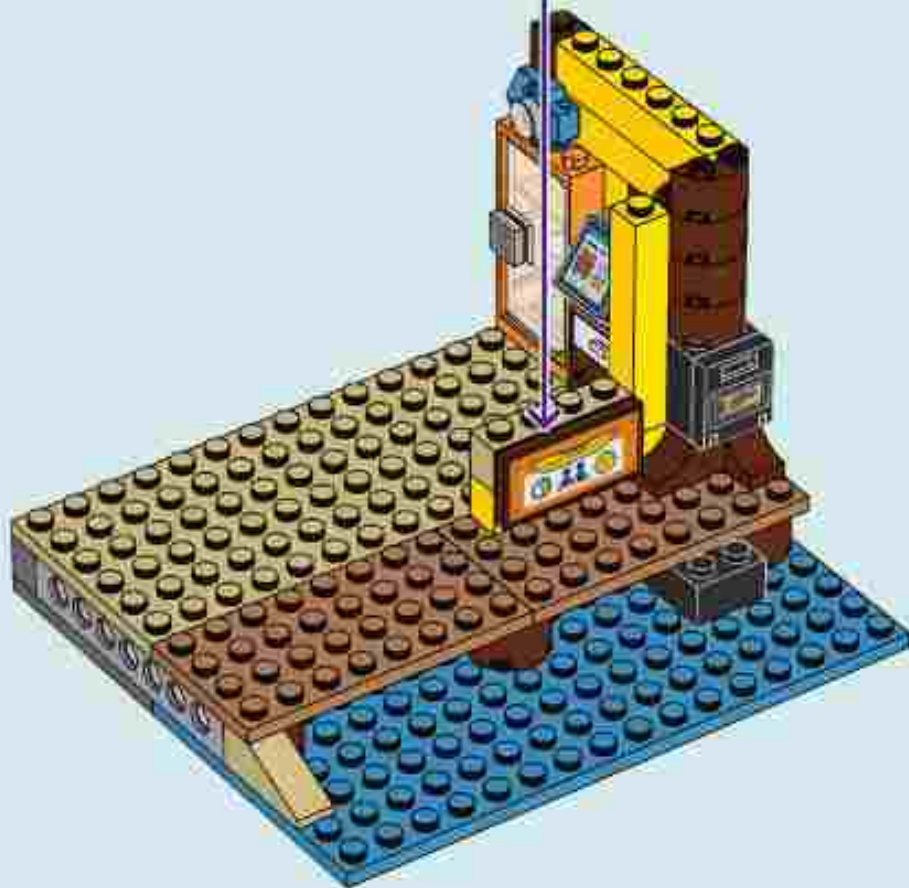





69

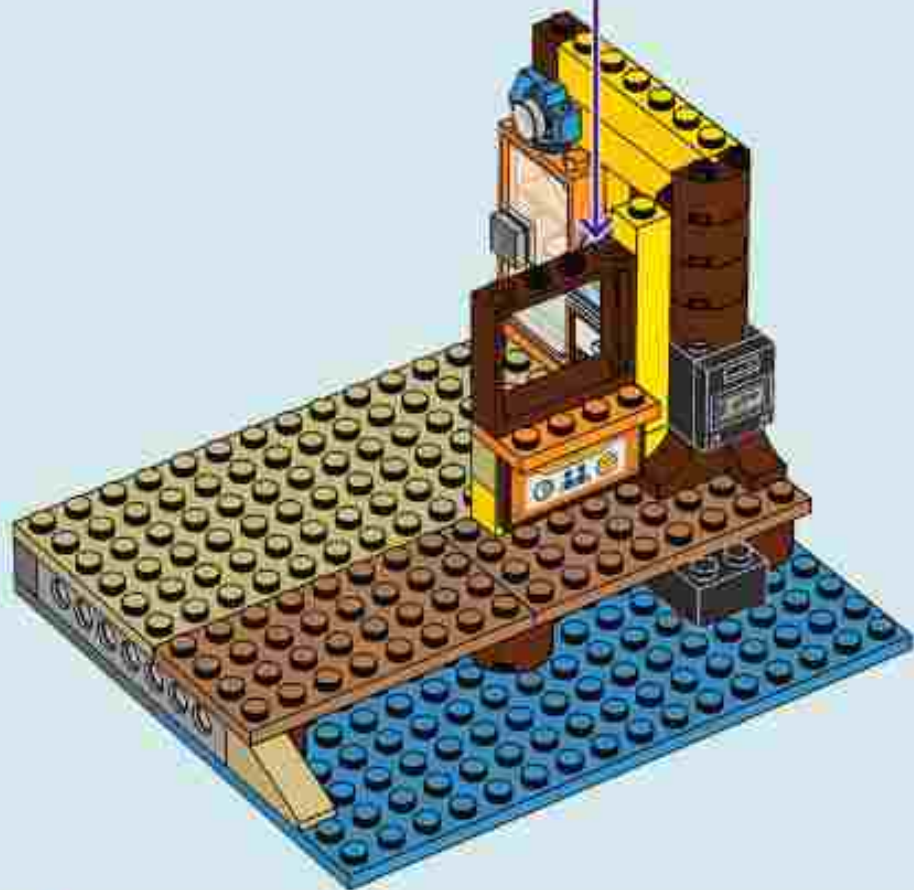
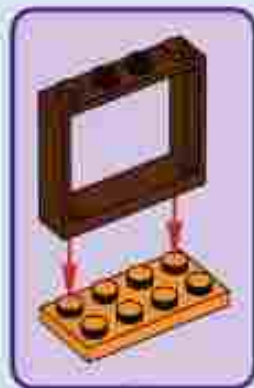

70

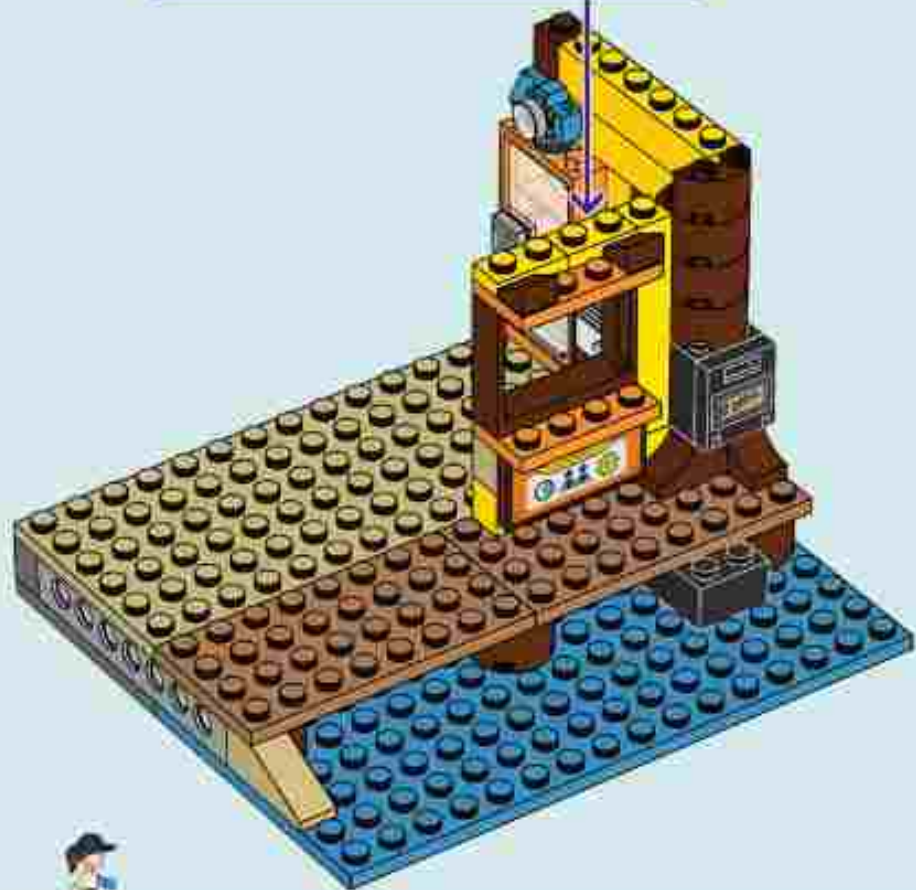



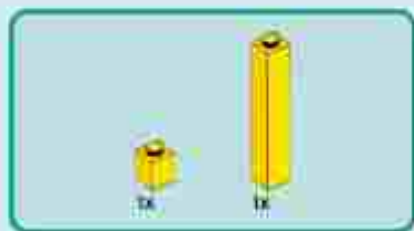

71

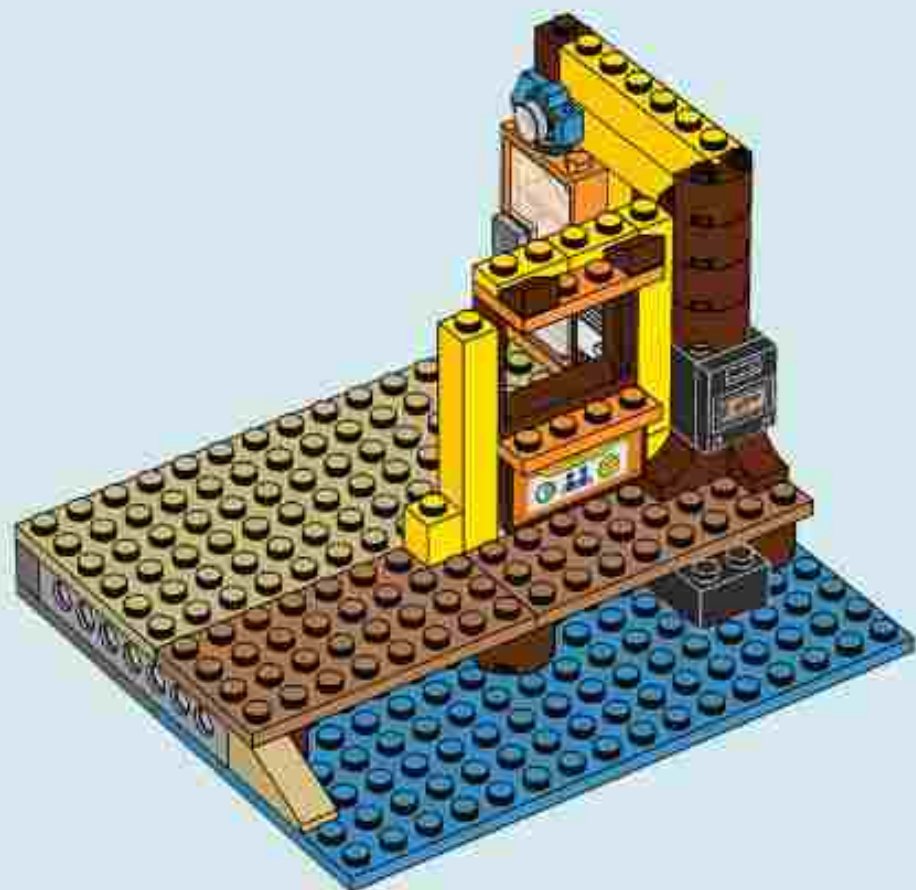

72

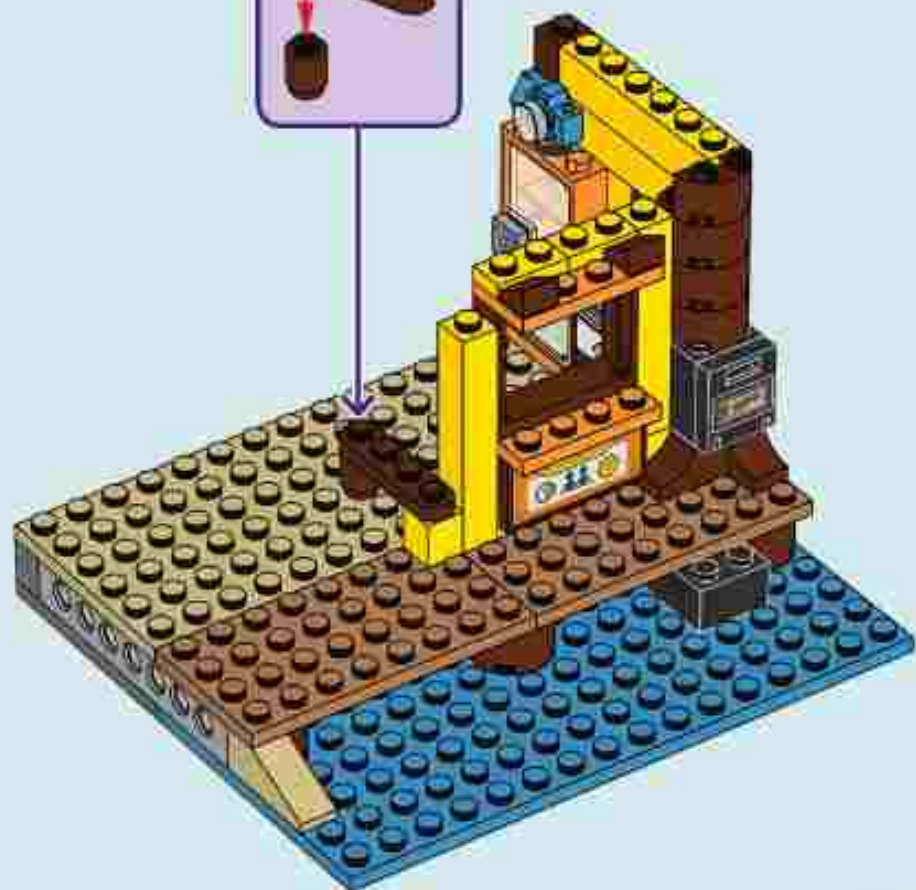



1x

73

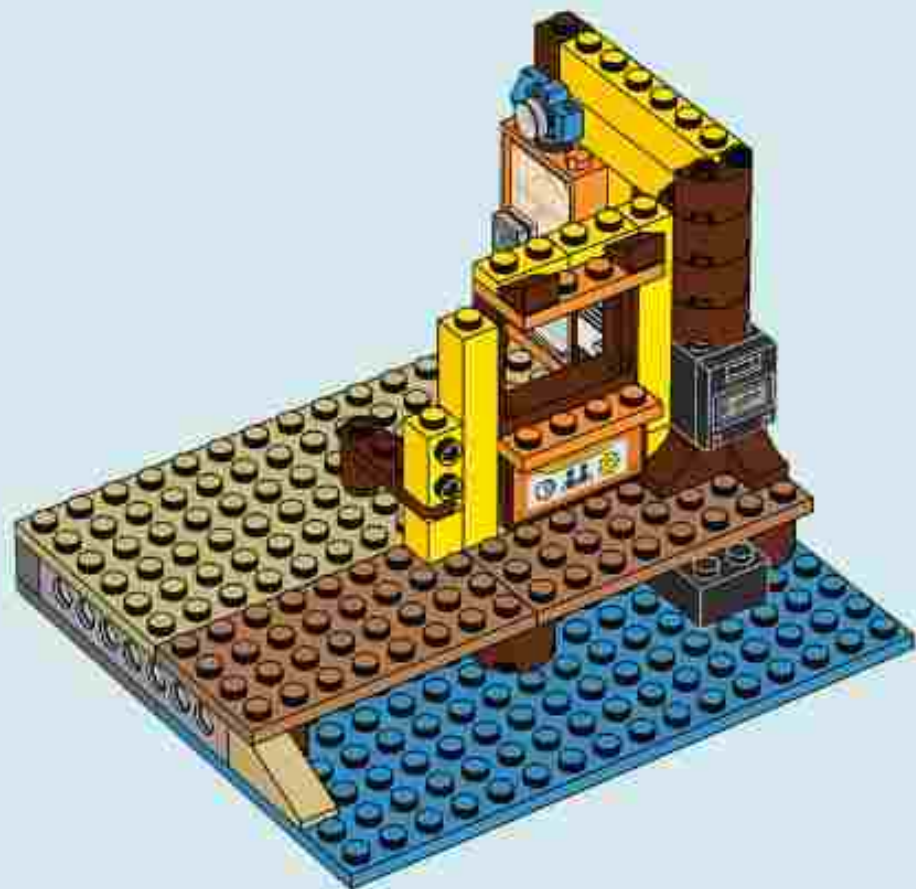

1x



1x

74

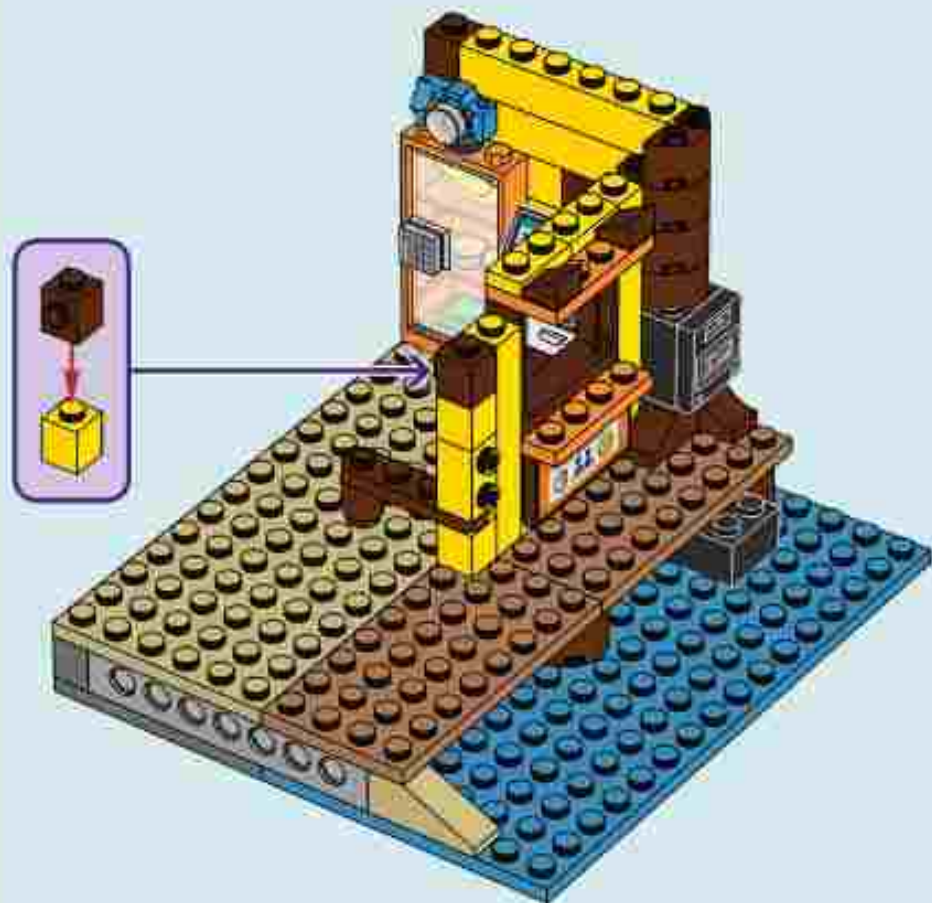





75

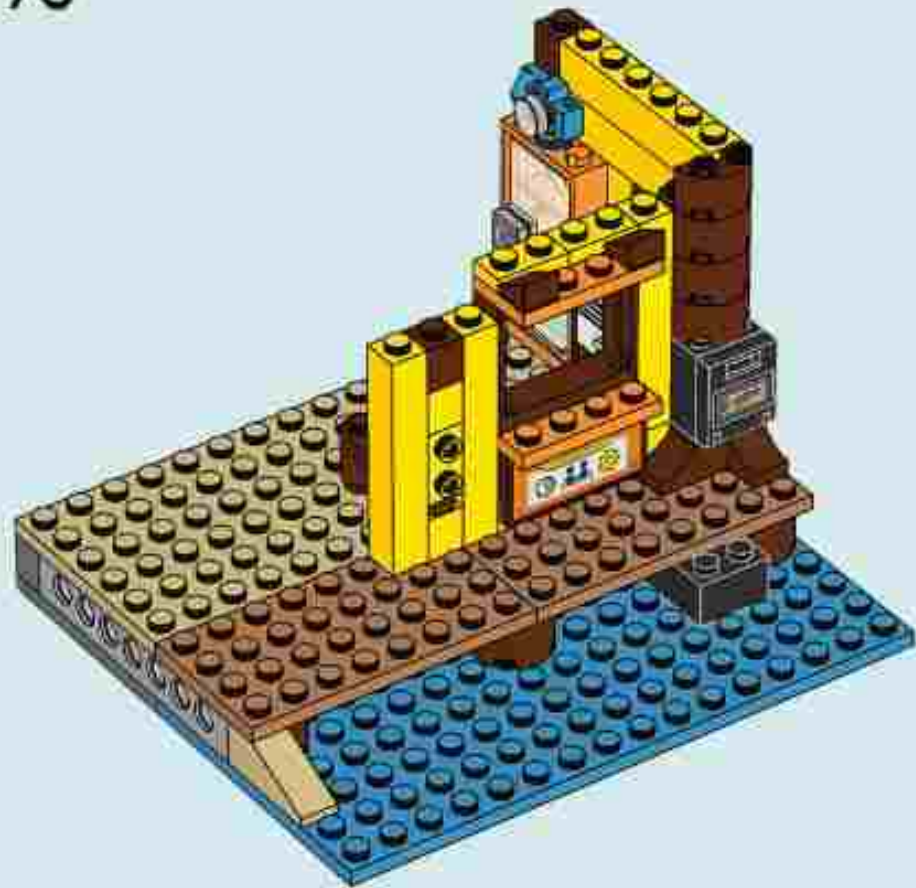

76

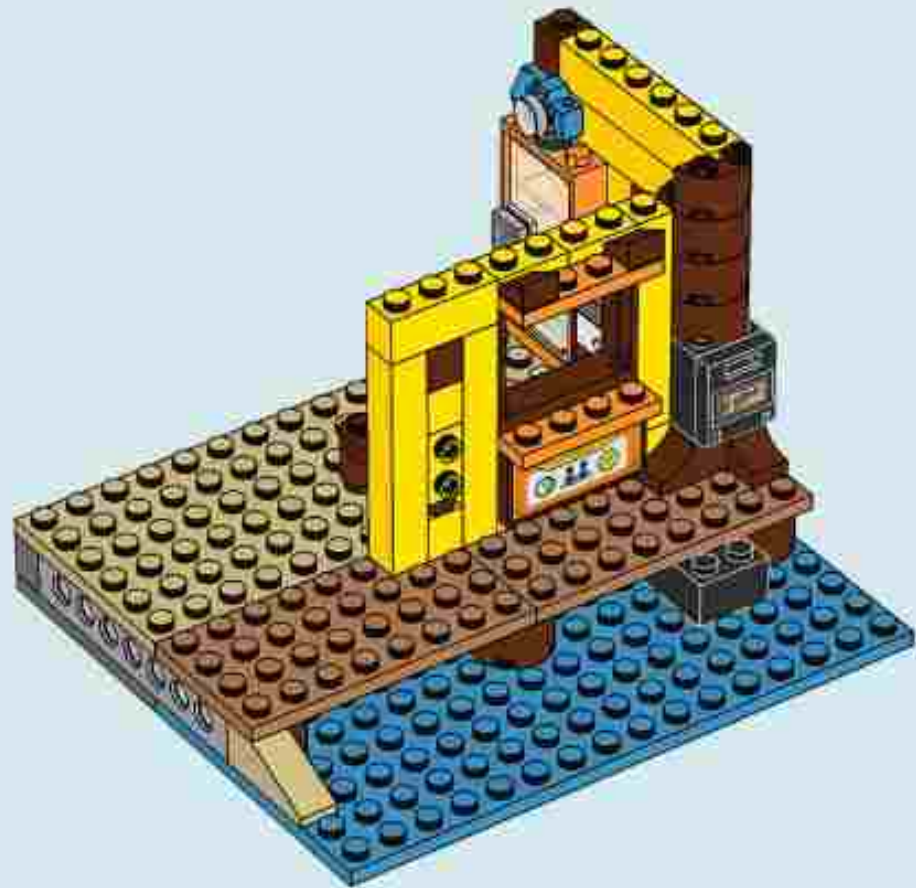



77

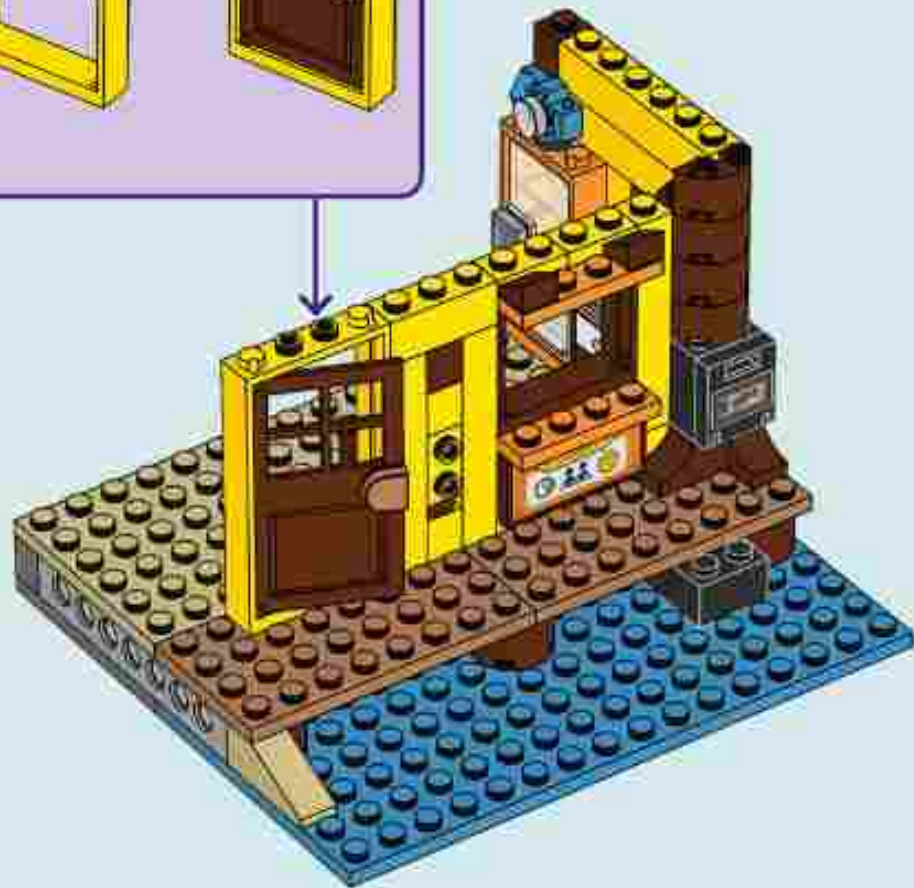
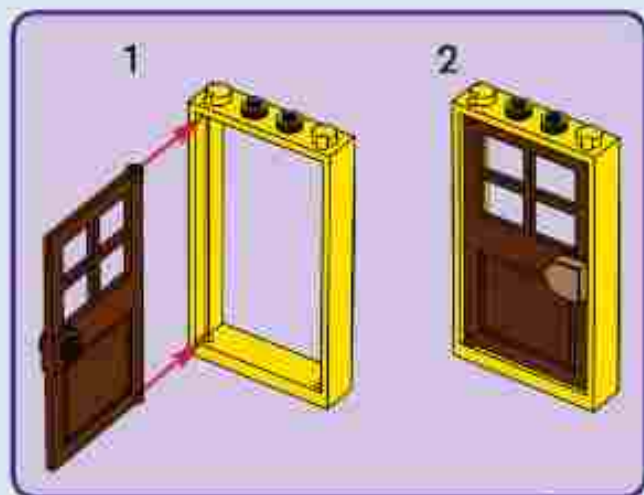



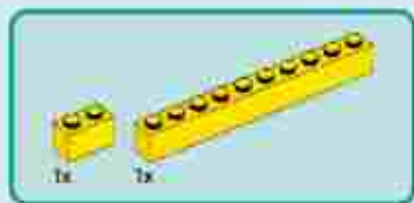

78

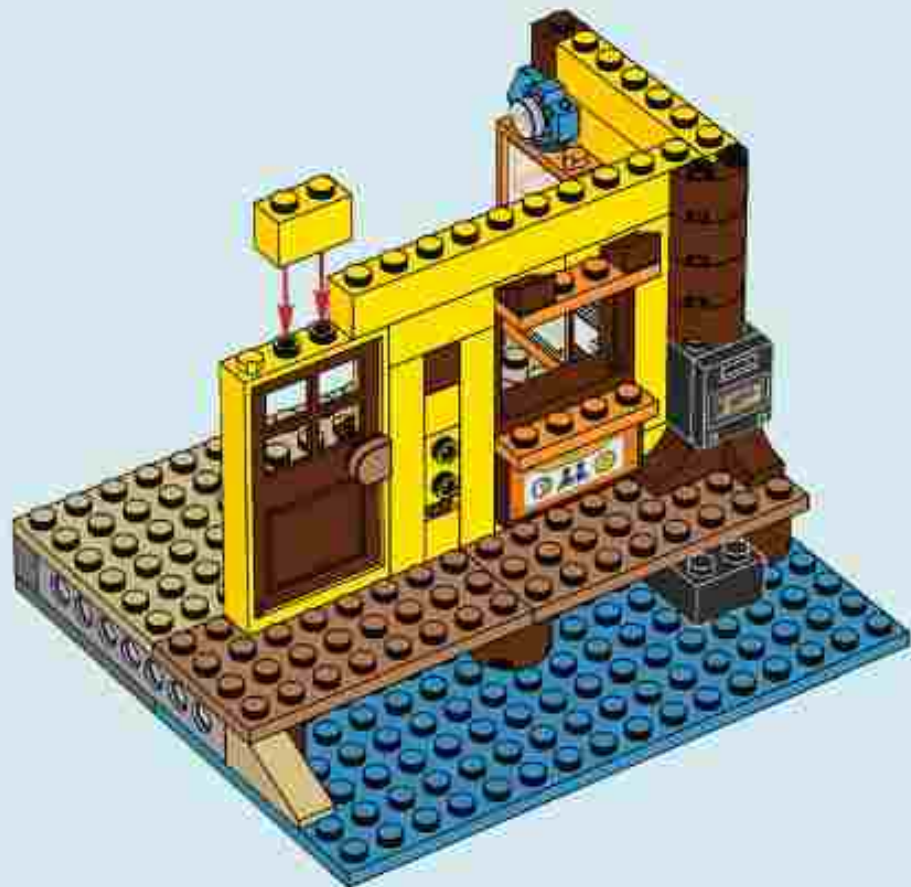

79





80





81

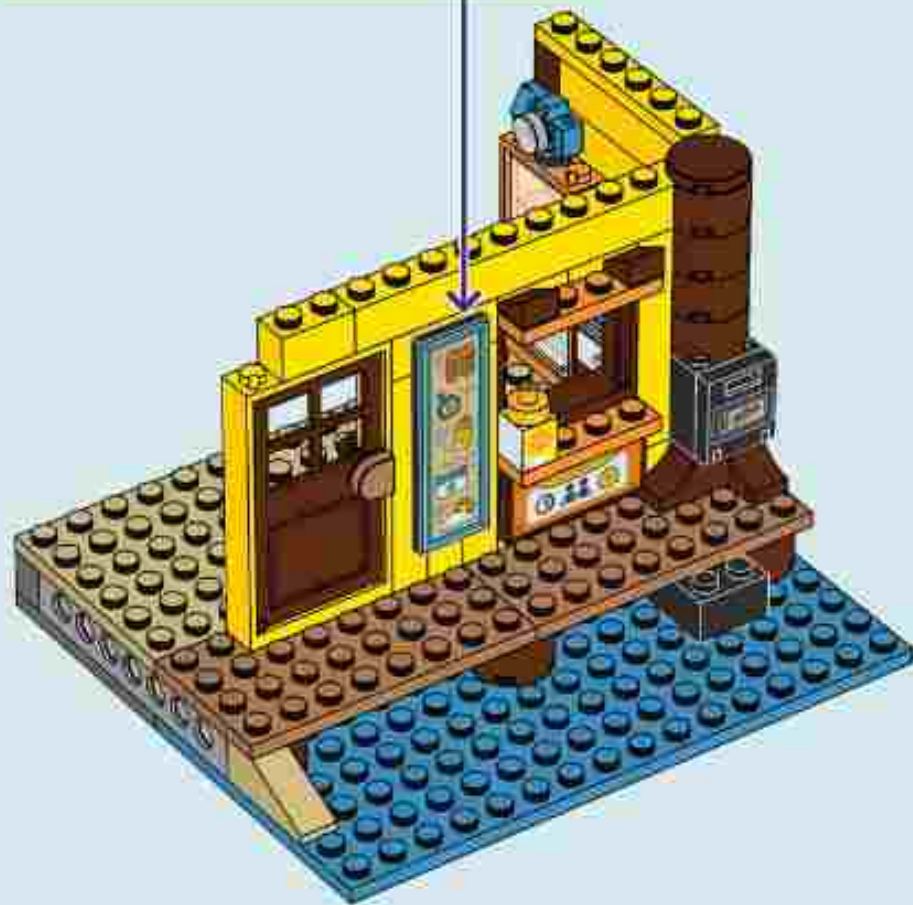



82



1

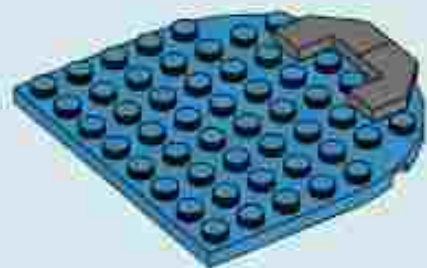

2

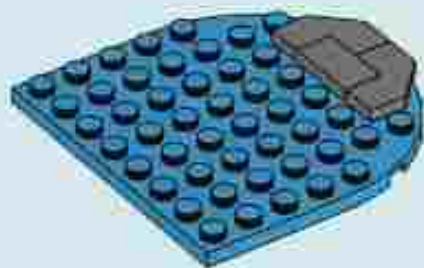

3

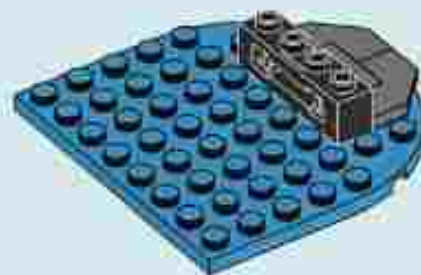



4



5

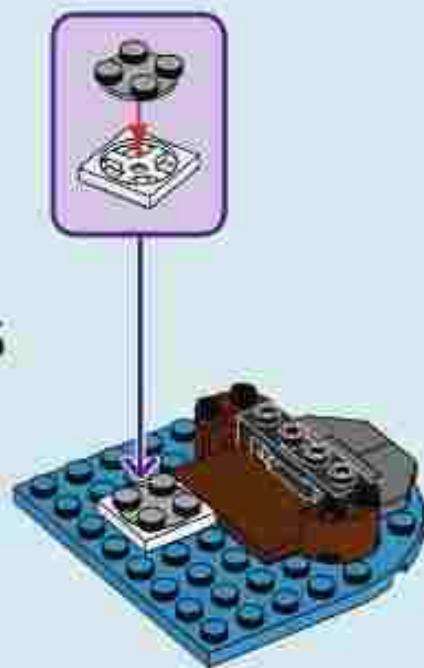

6







2x

83





2x

84







85





86

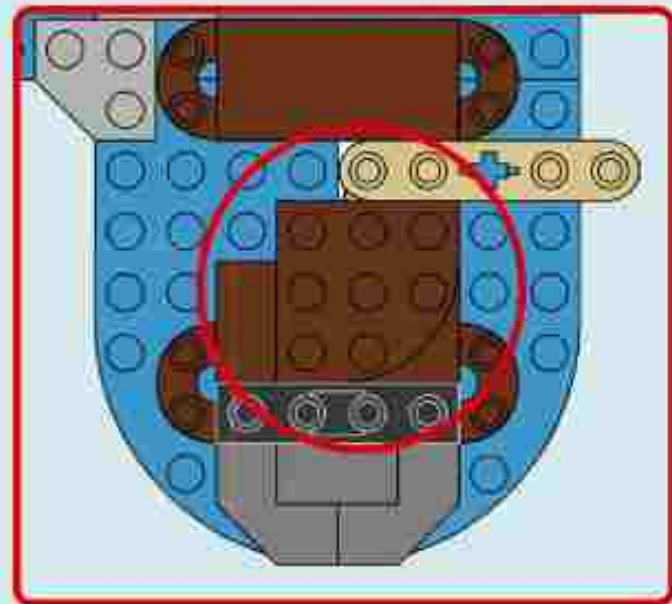
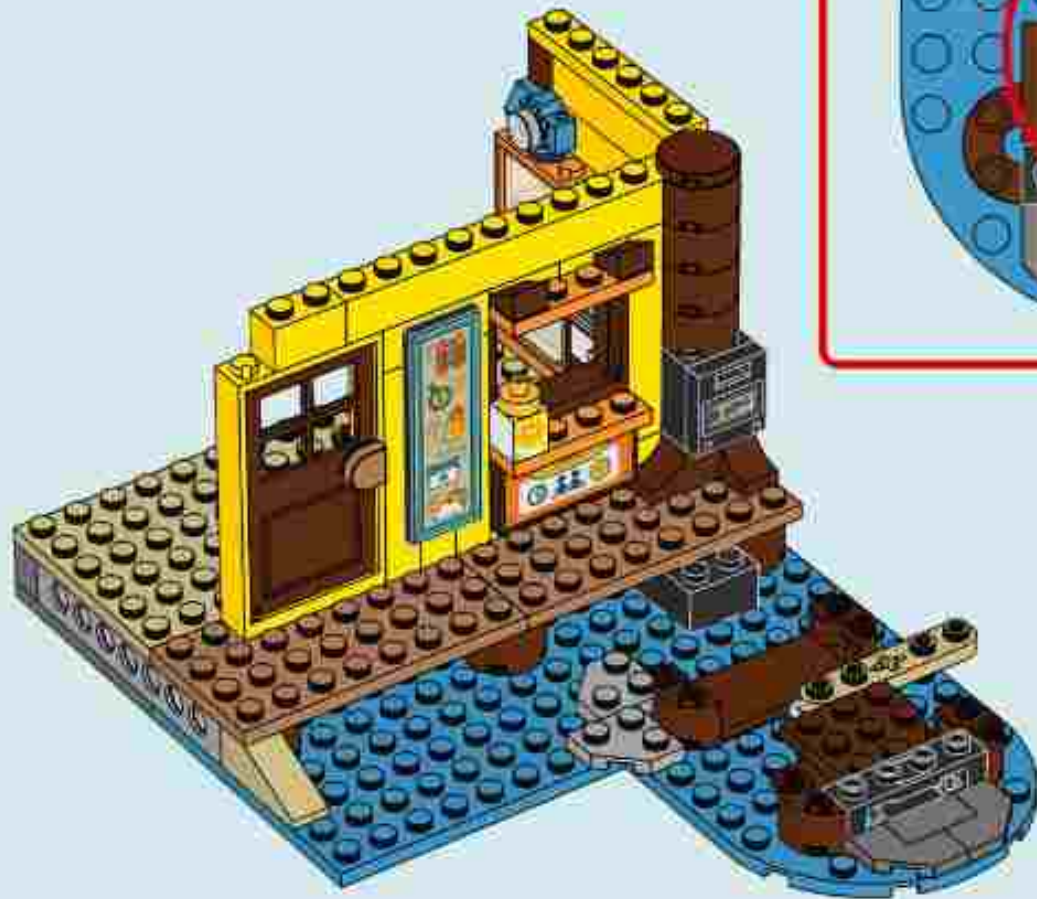



87





88







89







90



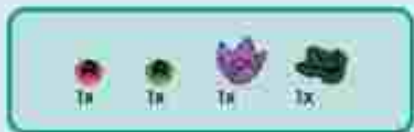

91







92





5x

93

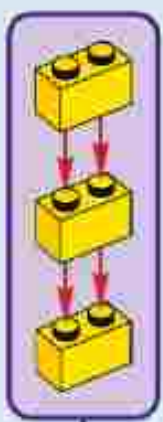



94





95

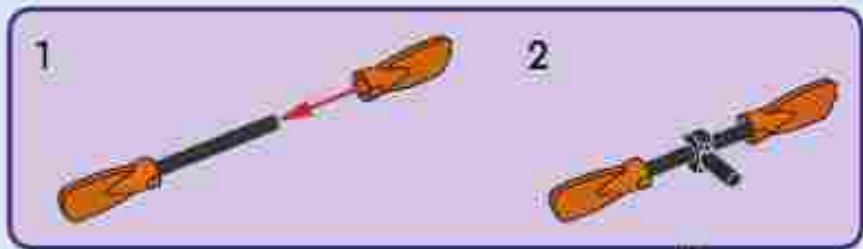



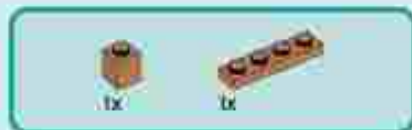

96



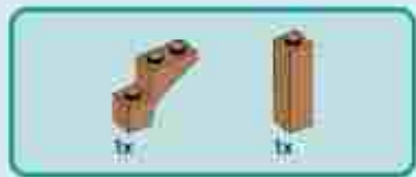

97

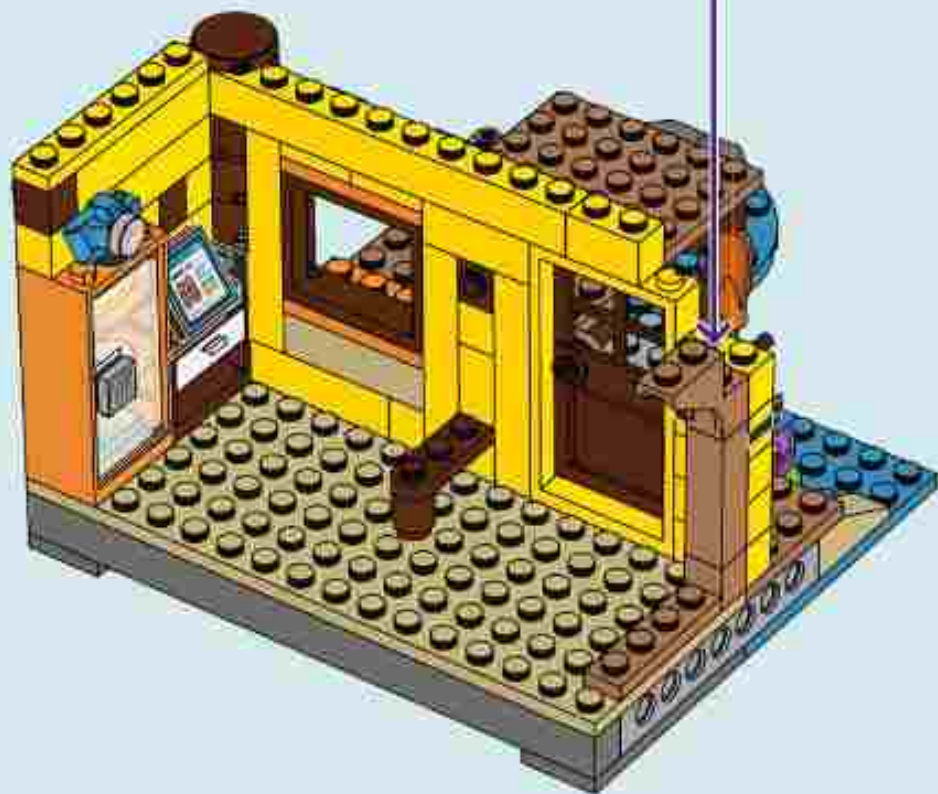
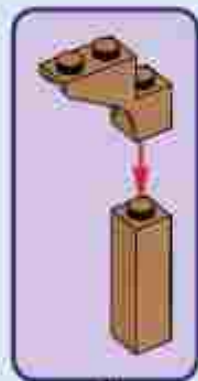



7A

98

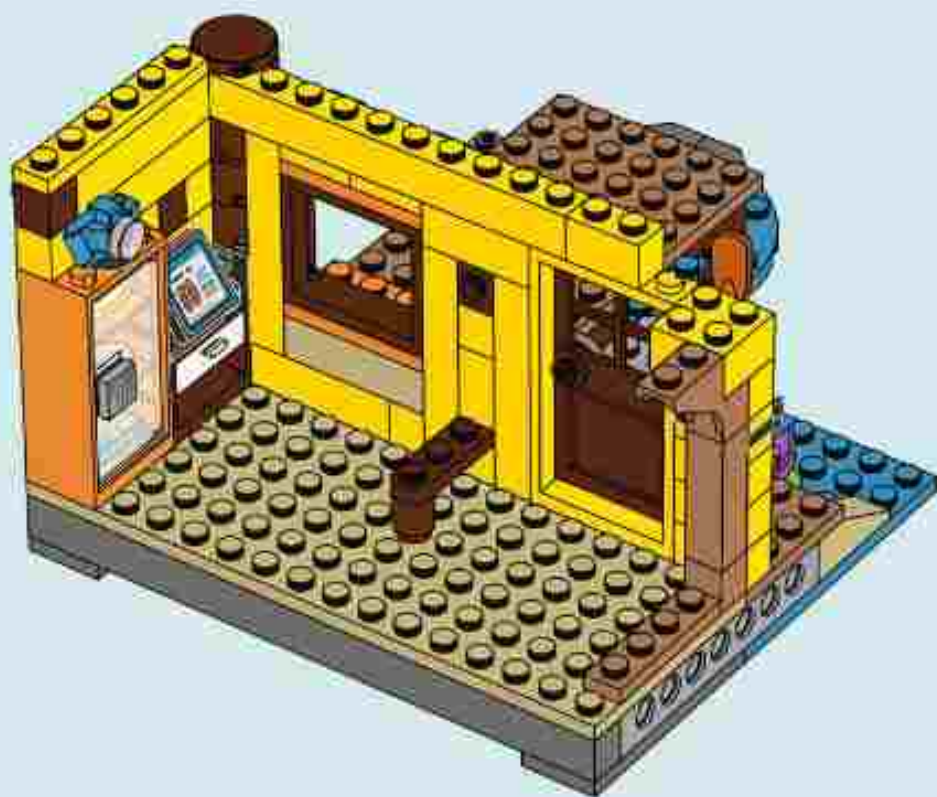



99







100

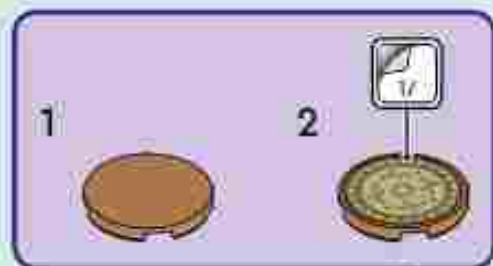



101



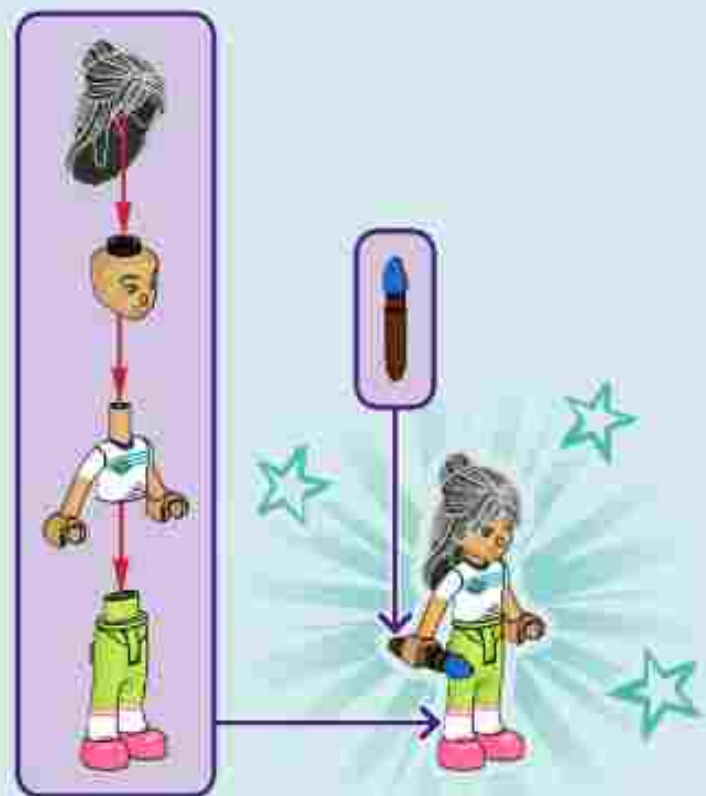

# LIANN





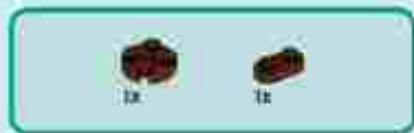

102



103



104

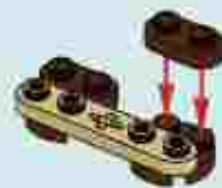

105





2x

106



2x

107



4x

108



1x



2x

109





110



111

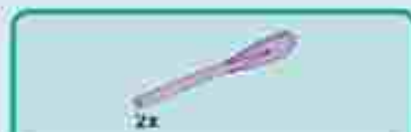
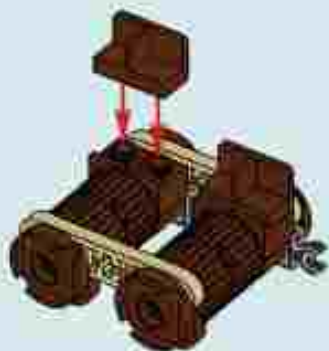

112

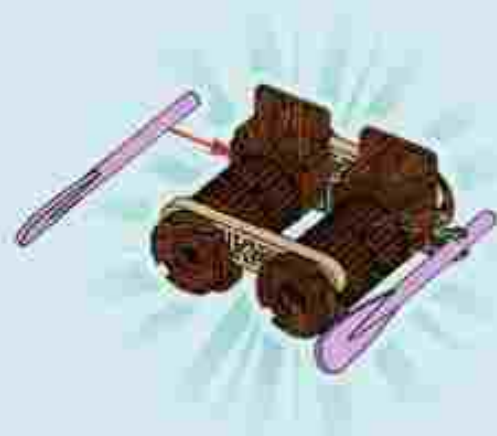

2x

113







114

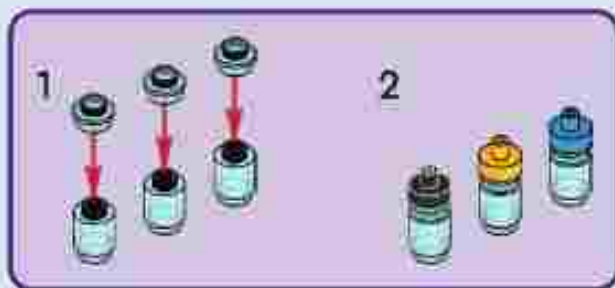

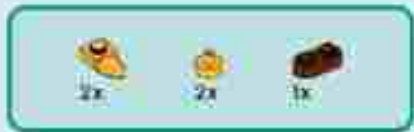

115

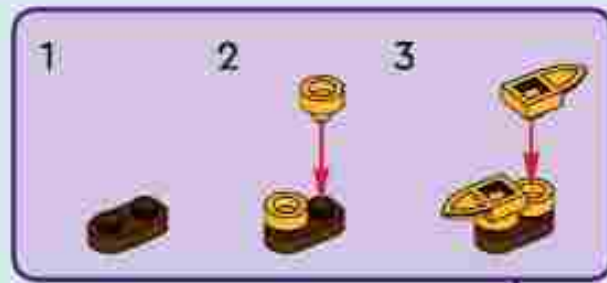

116

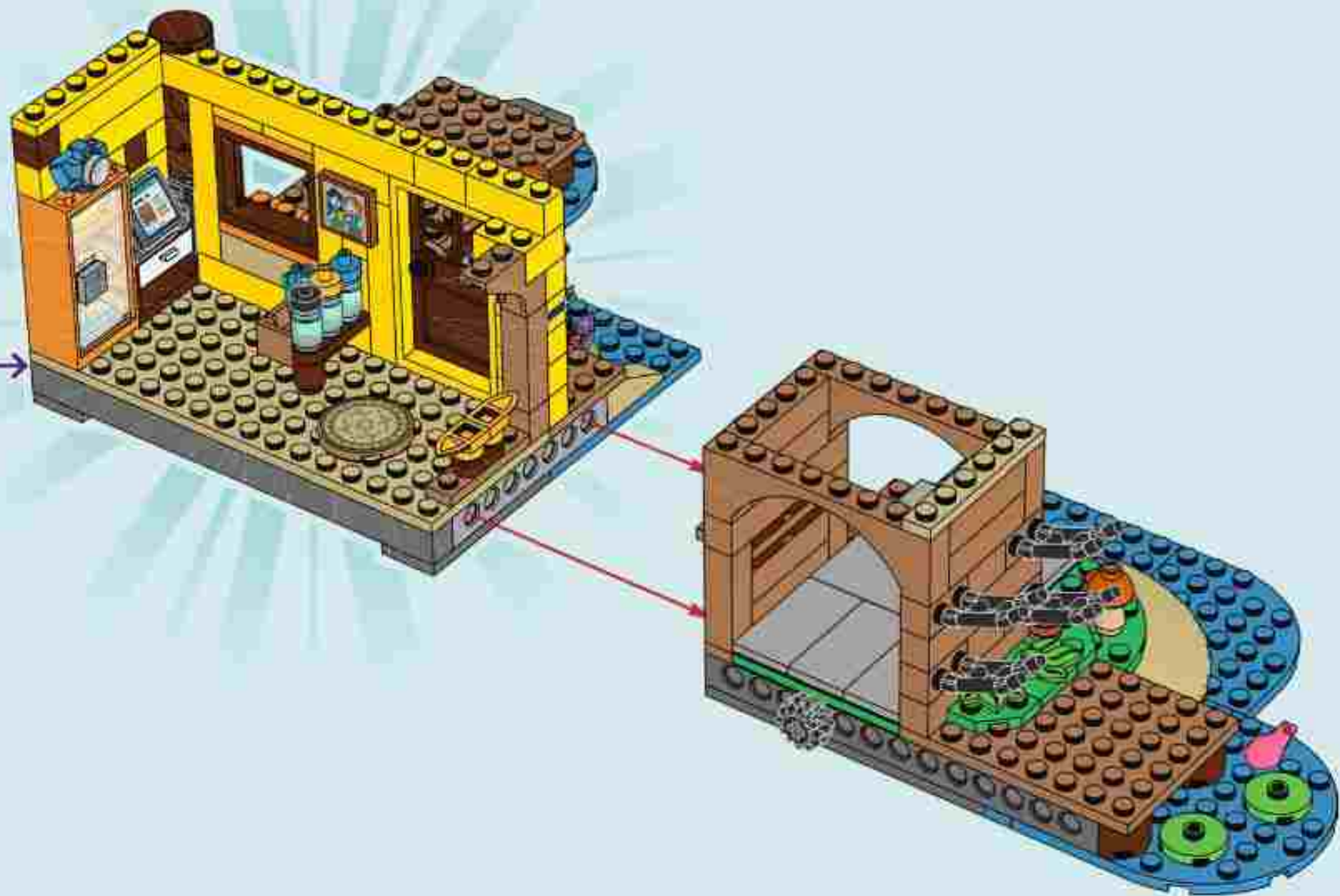





117

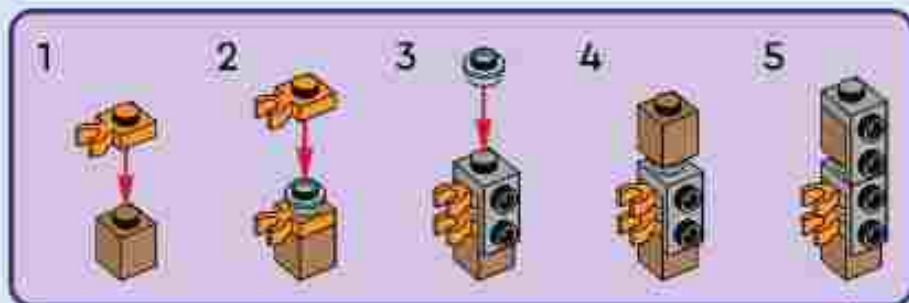





118





2x

119

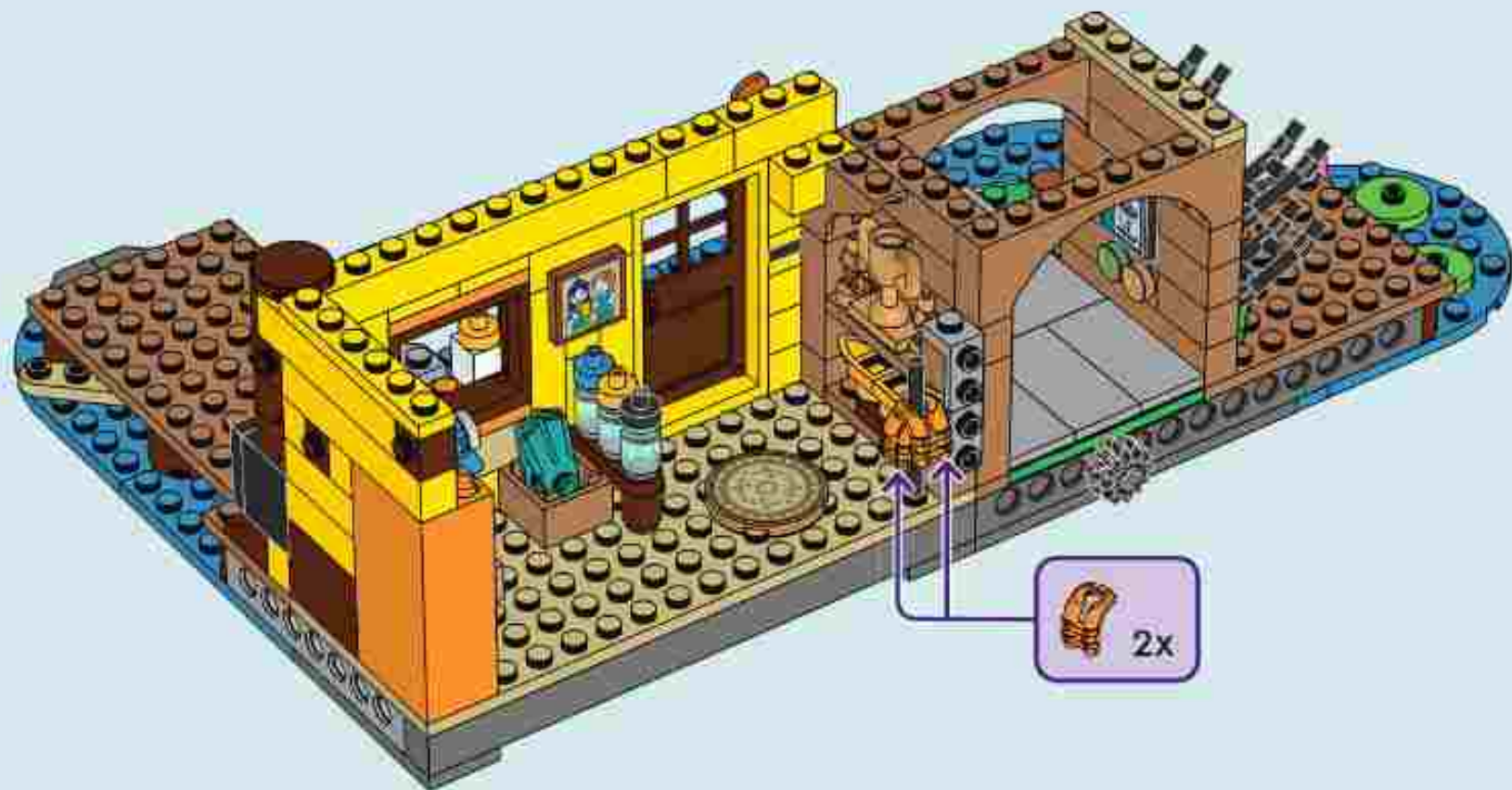

2x



120

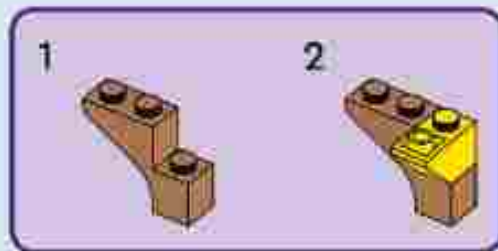





121





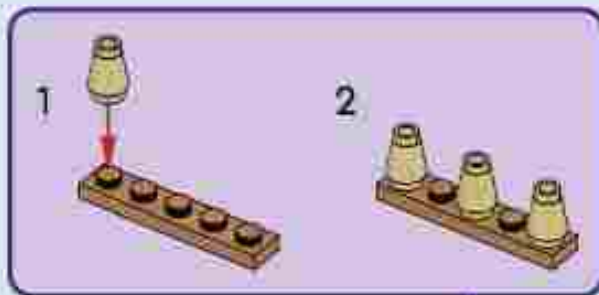

122

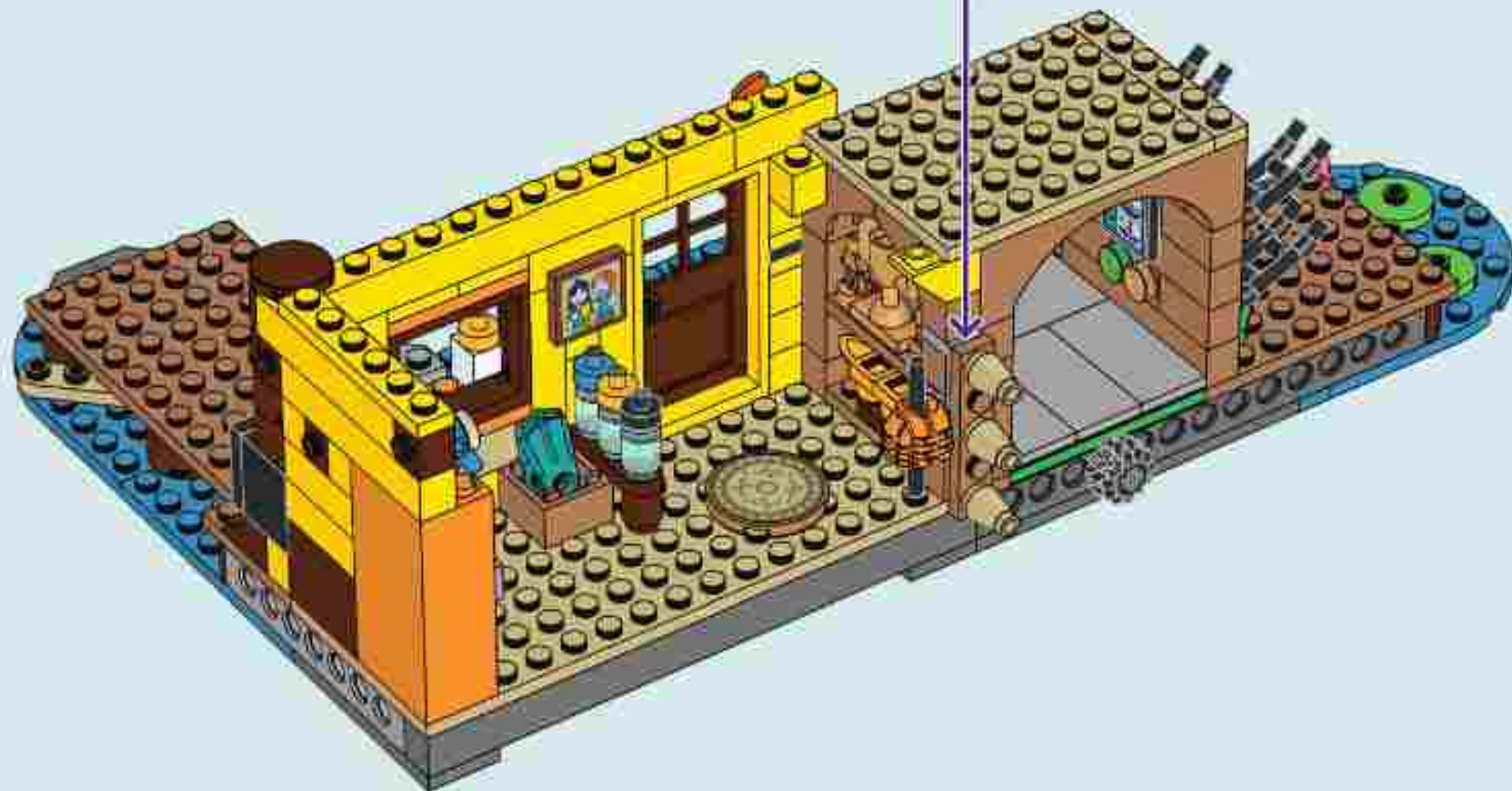



123

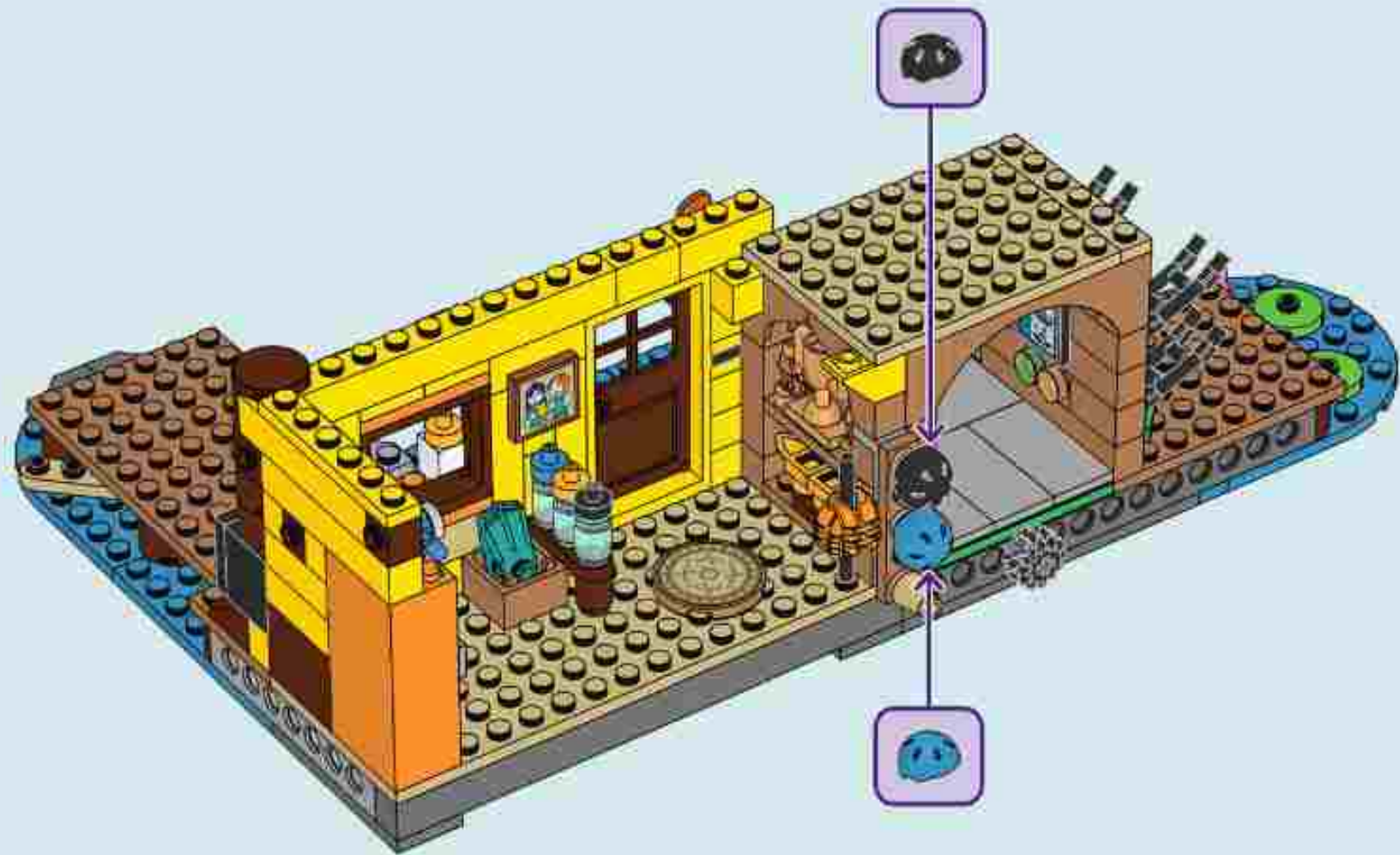



124







125







126

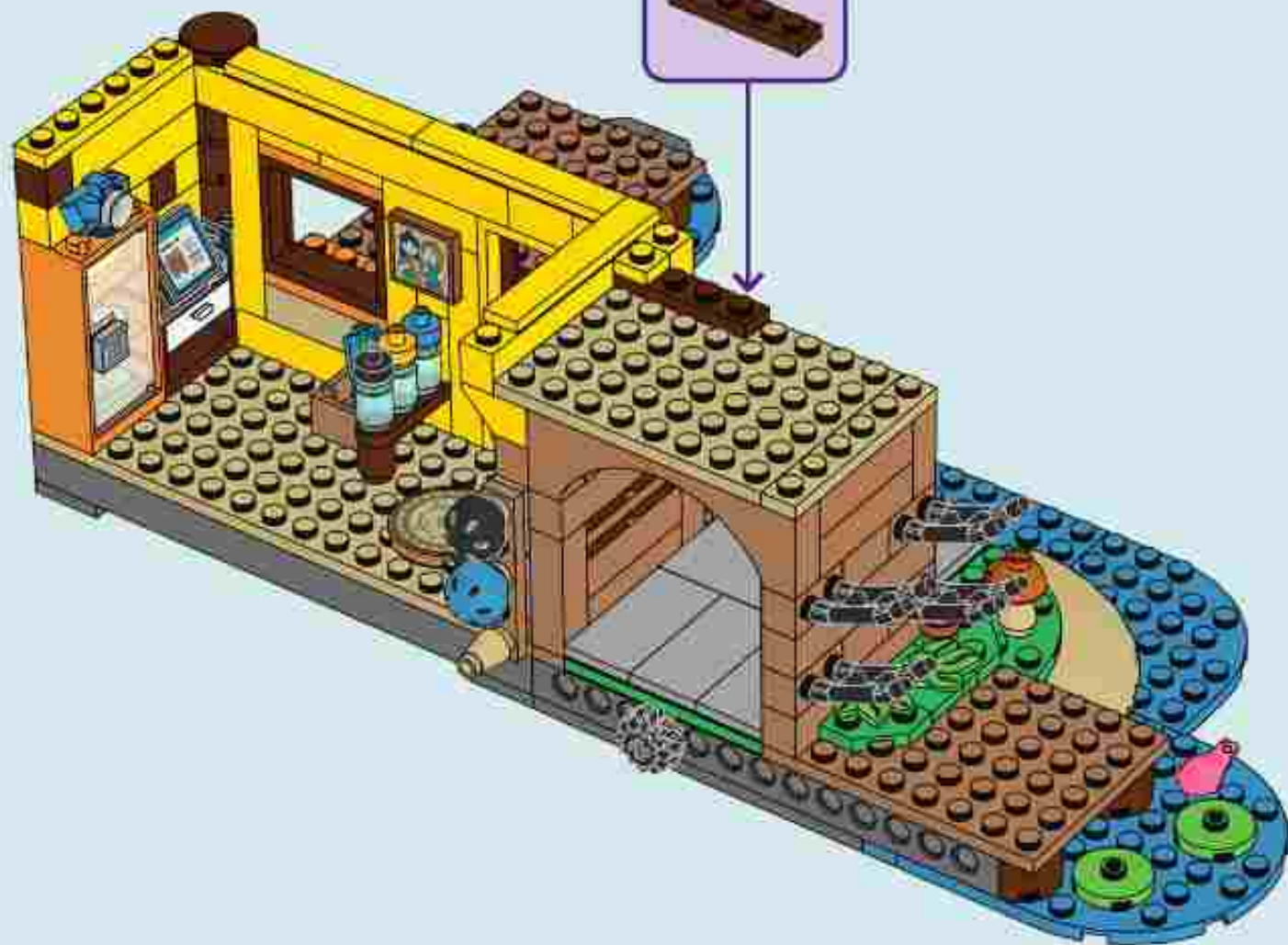



127

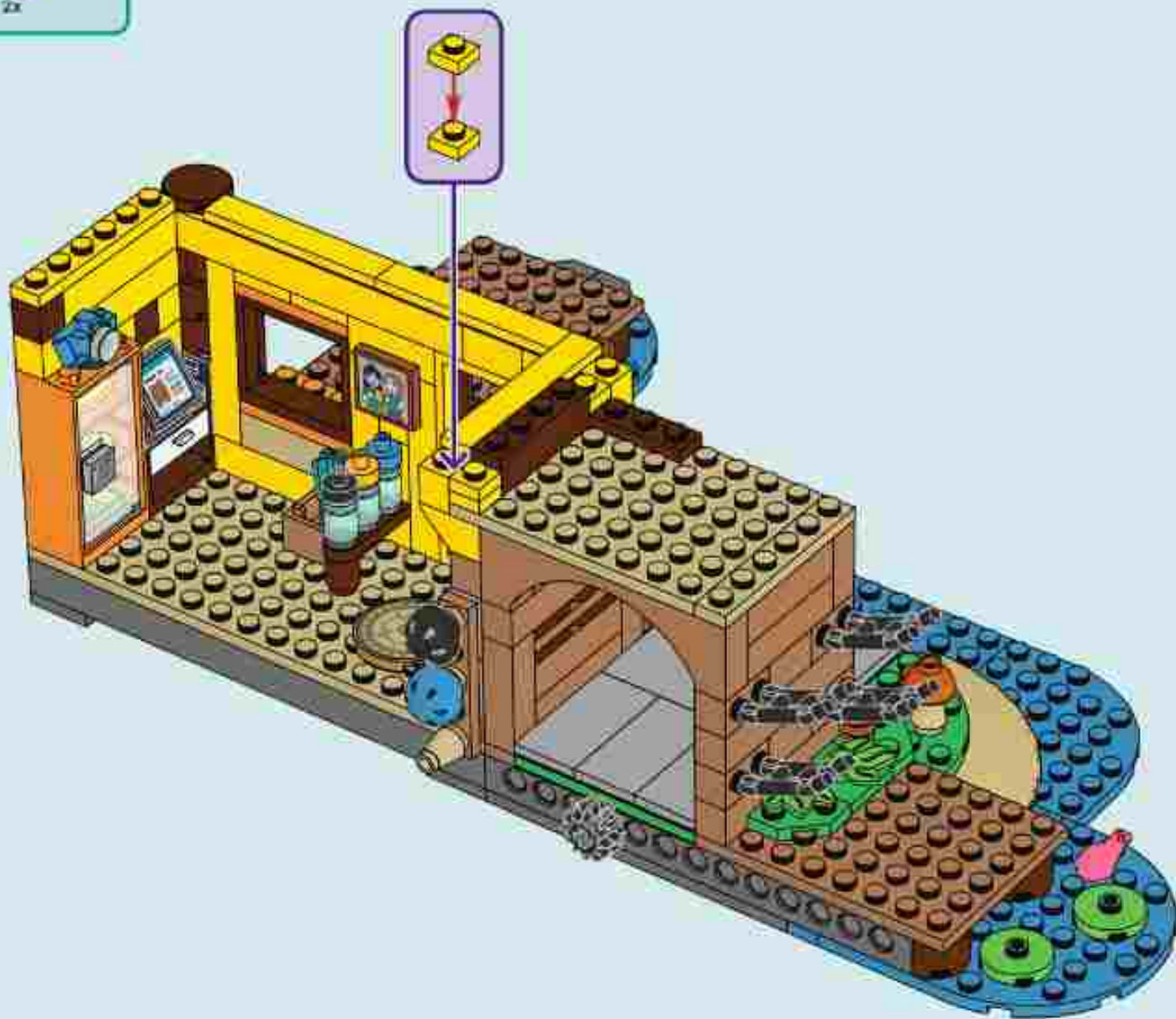



128

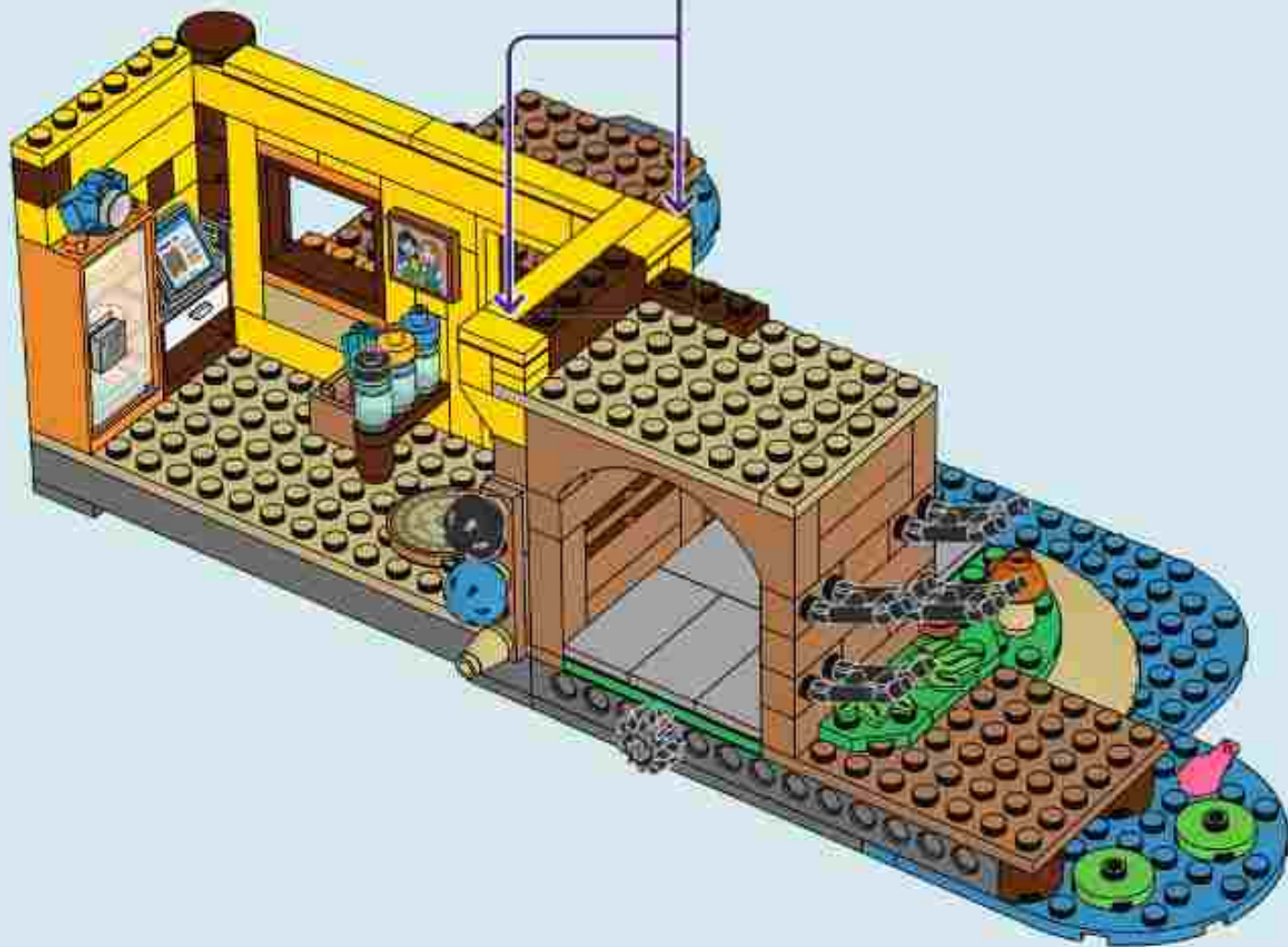





129

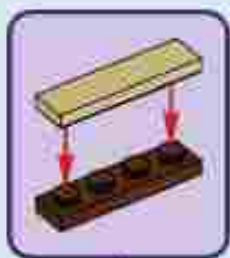





130

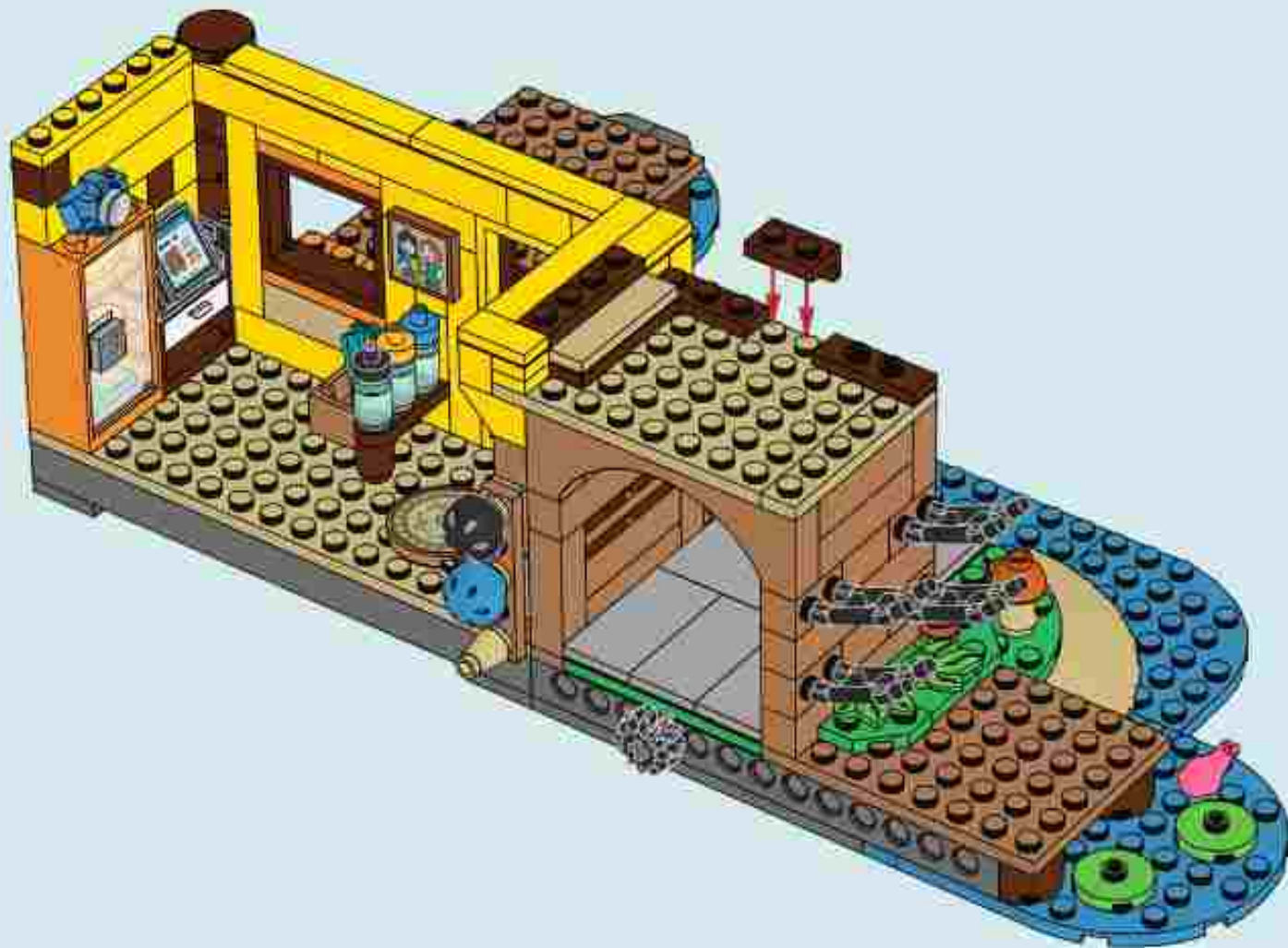



2x

131

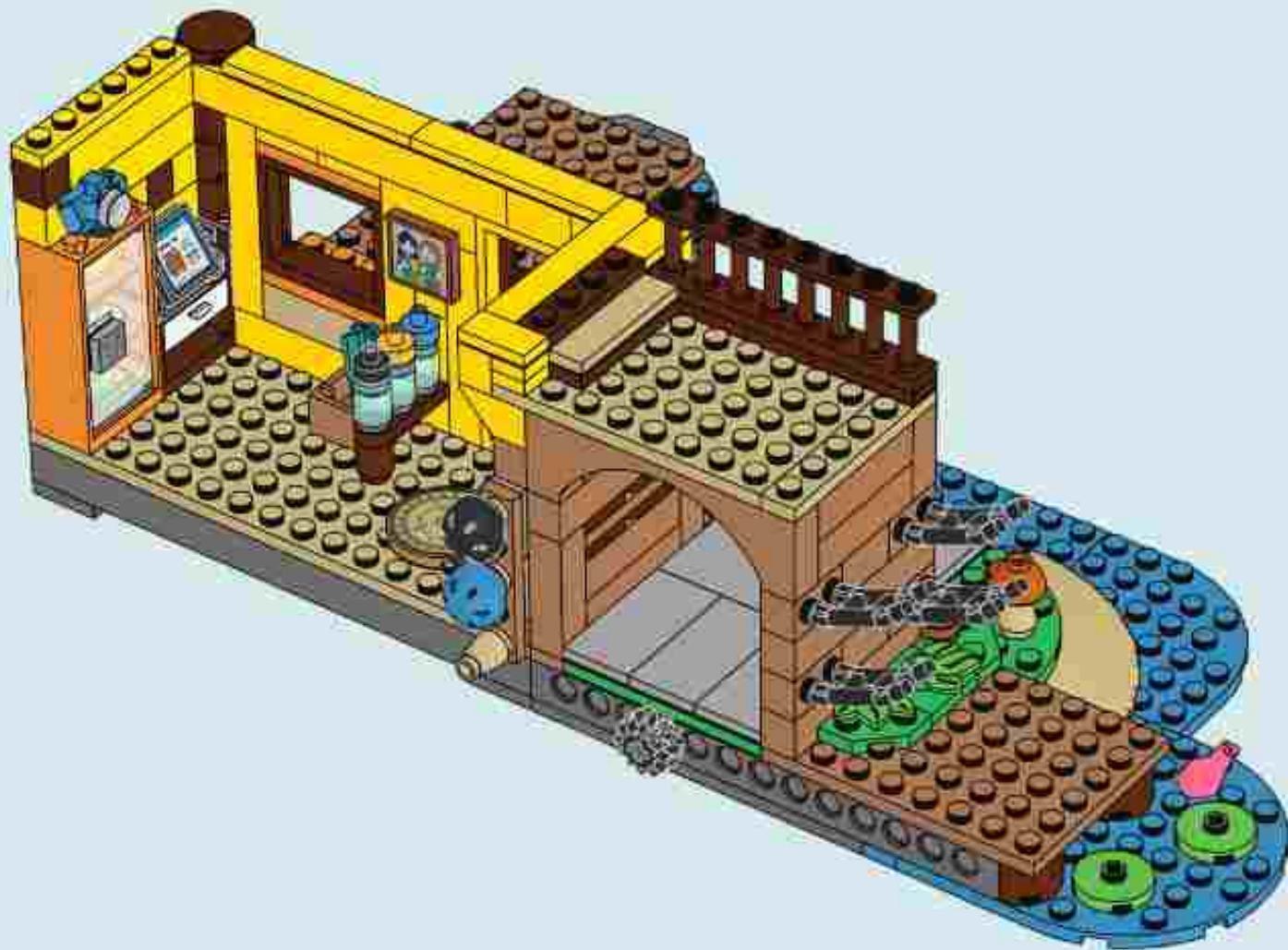



132

1

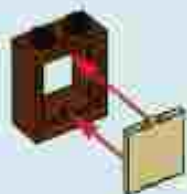

2



3



4

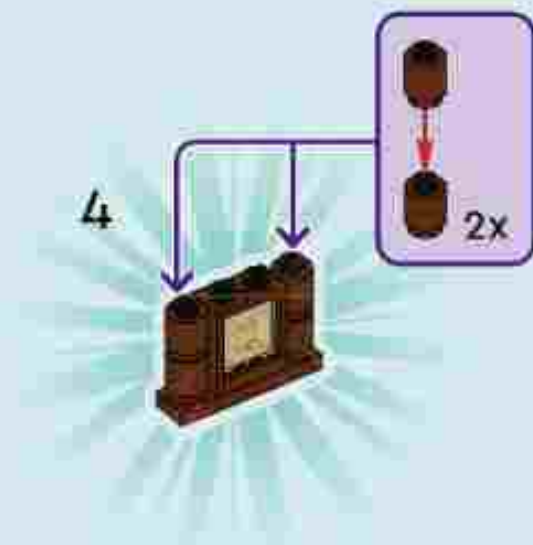



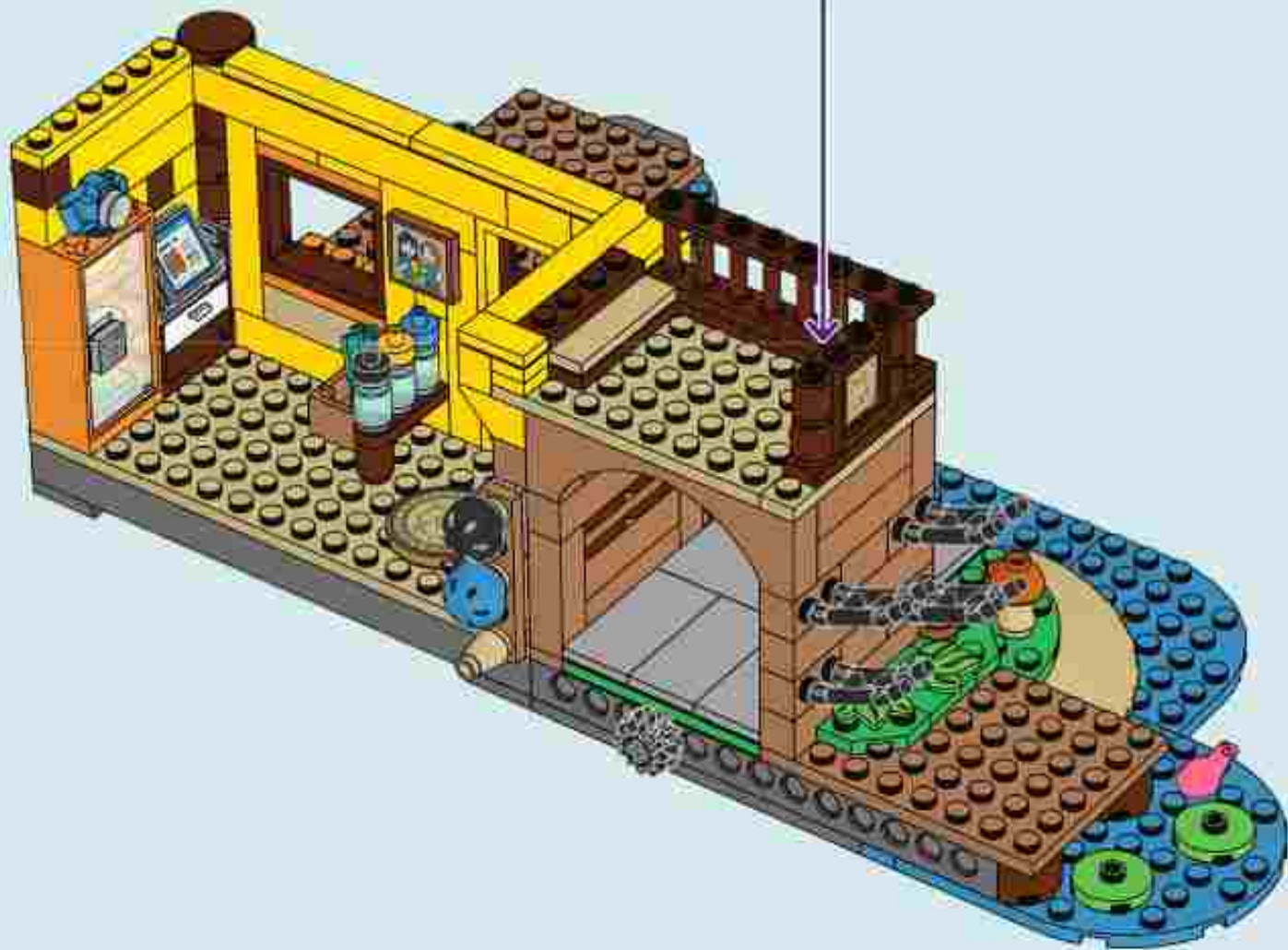





133

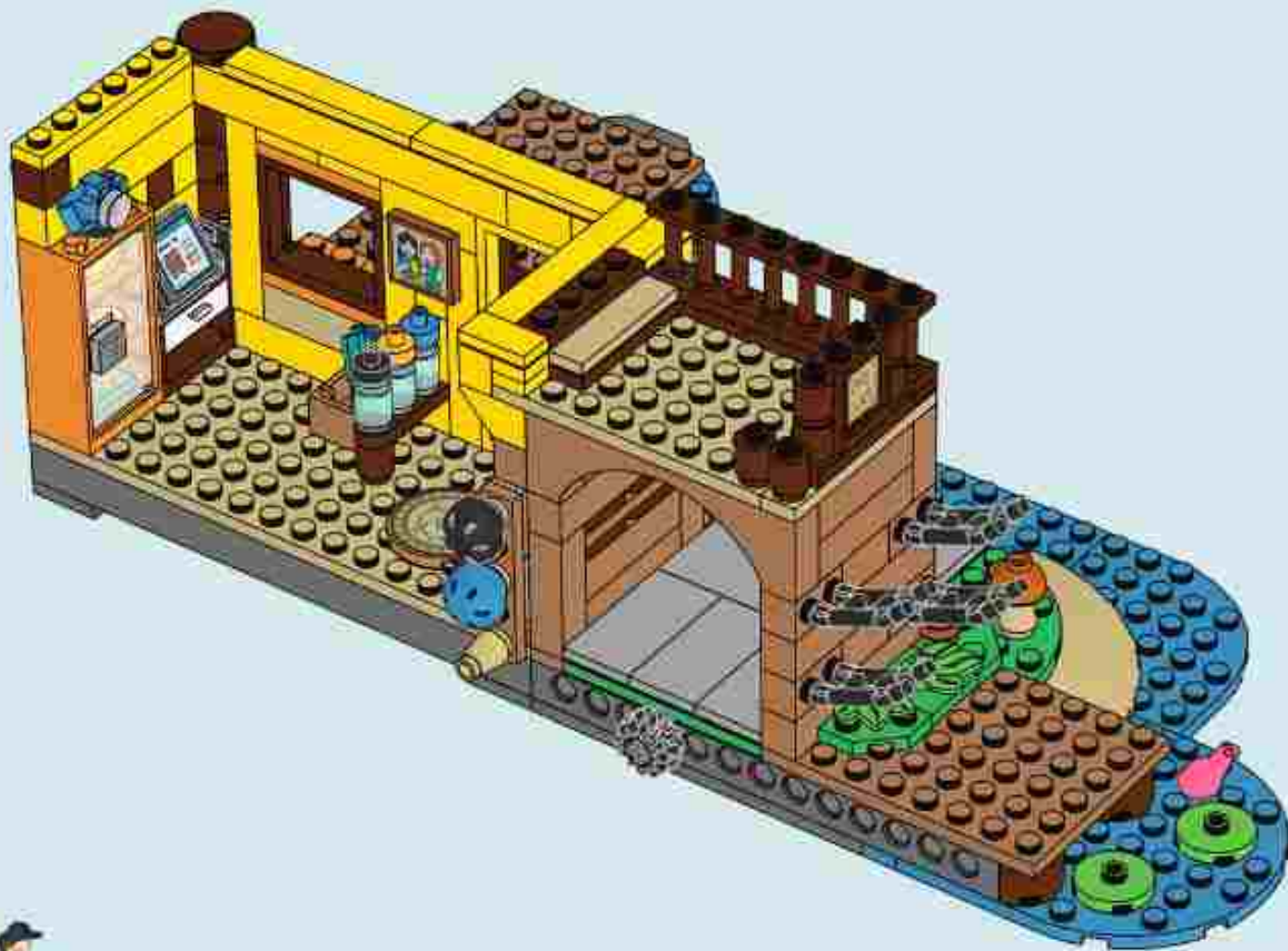



134

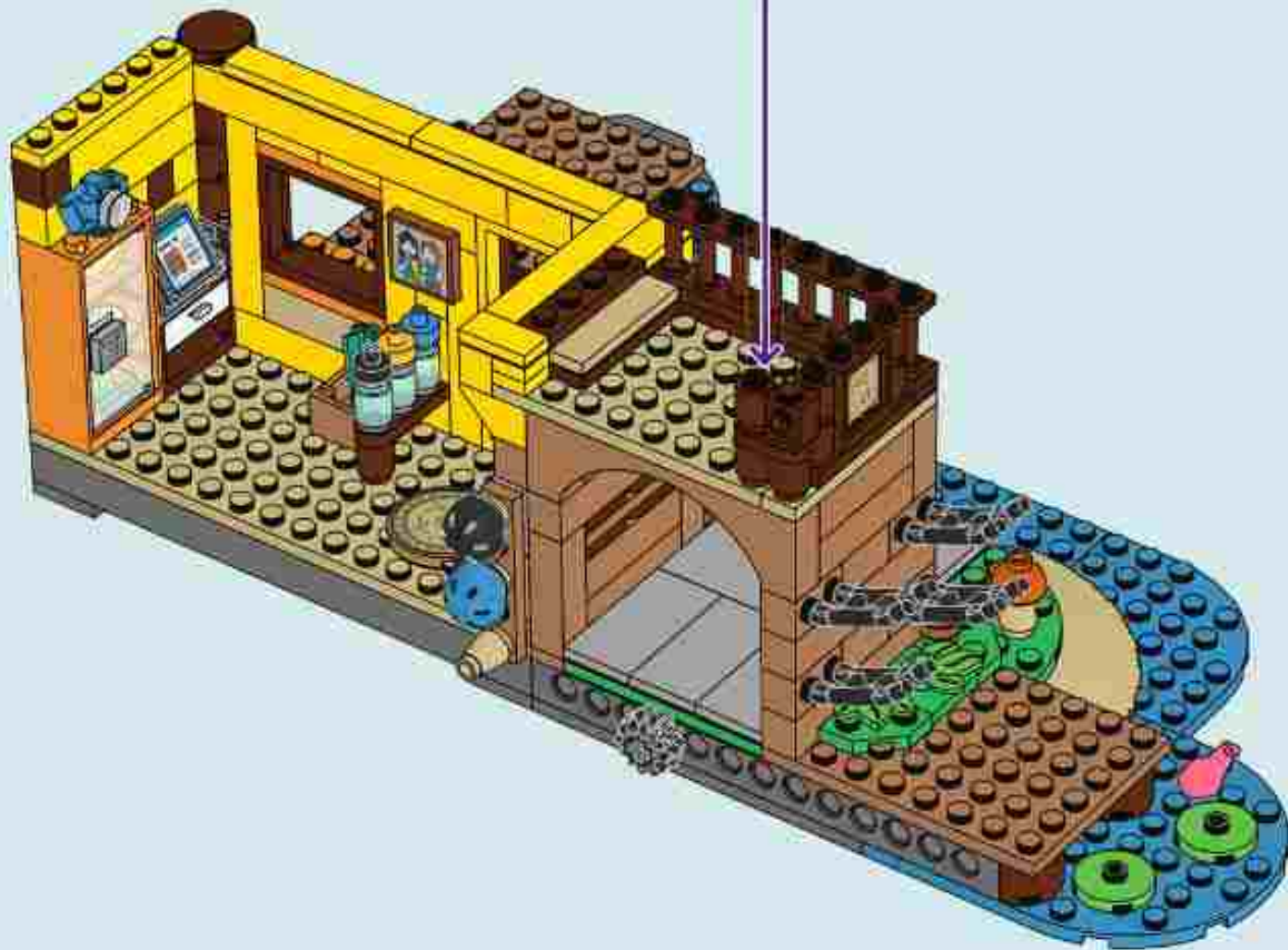
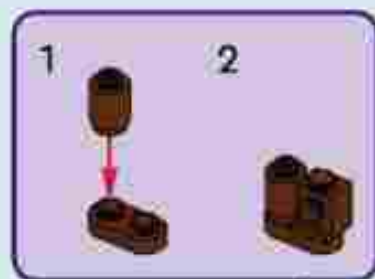



135

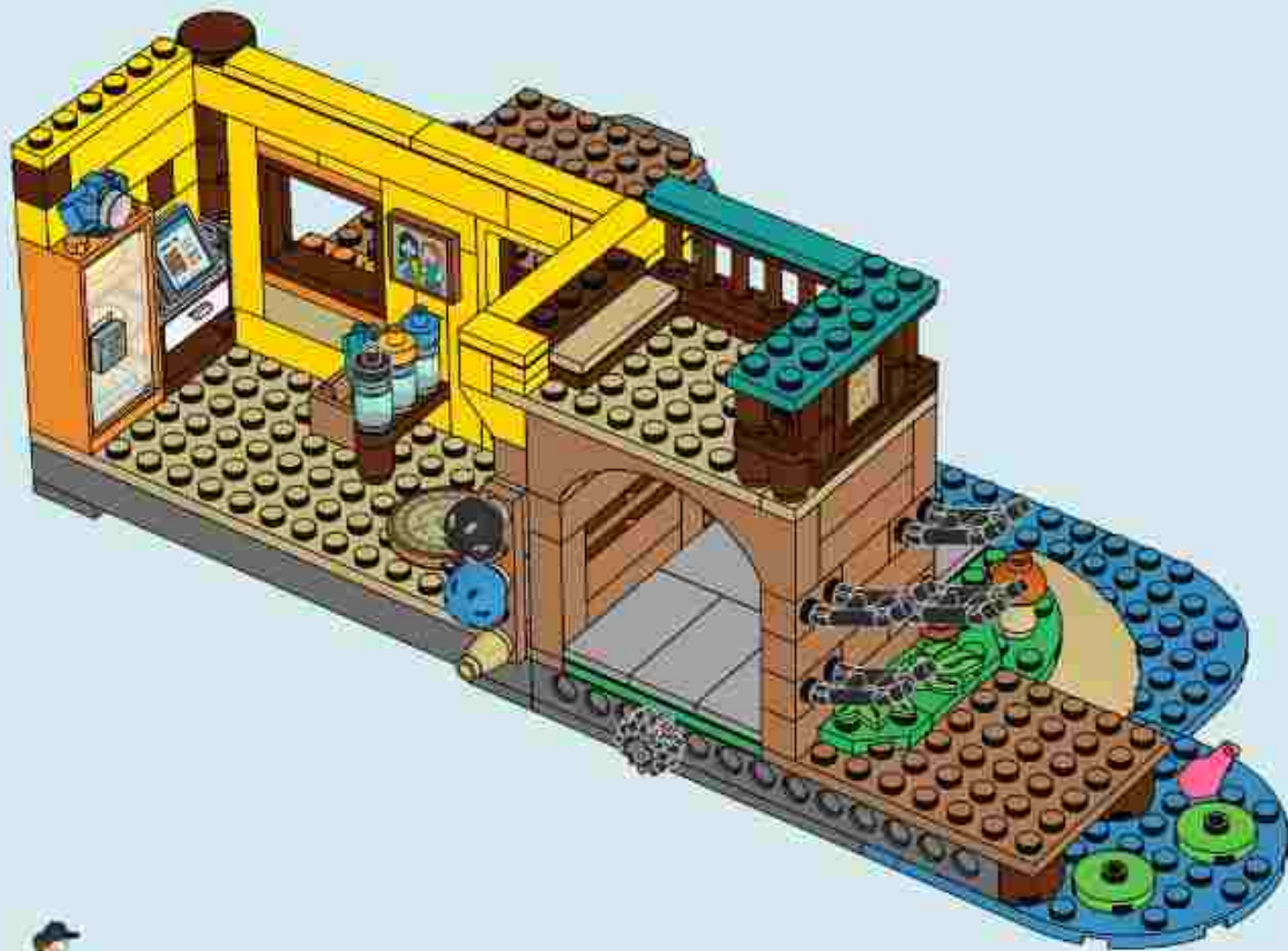





136







137

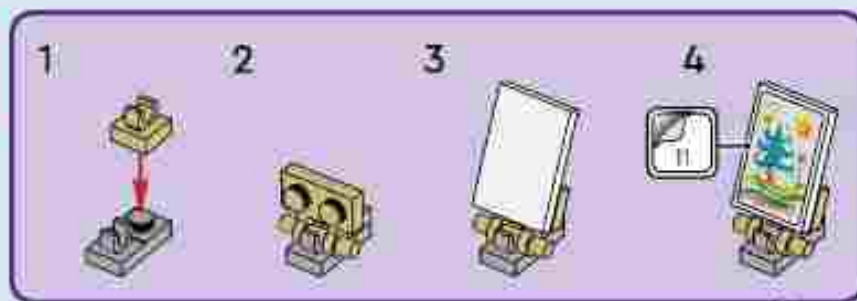



138

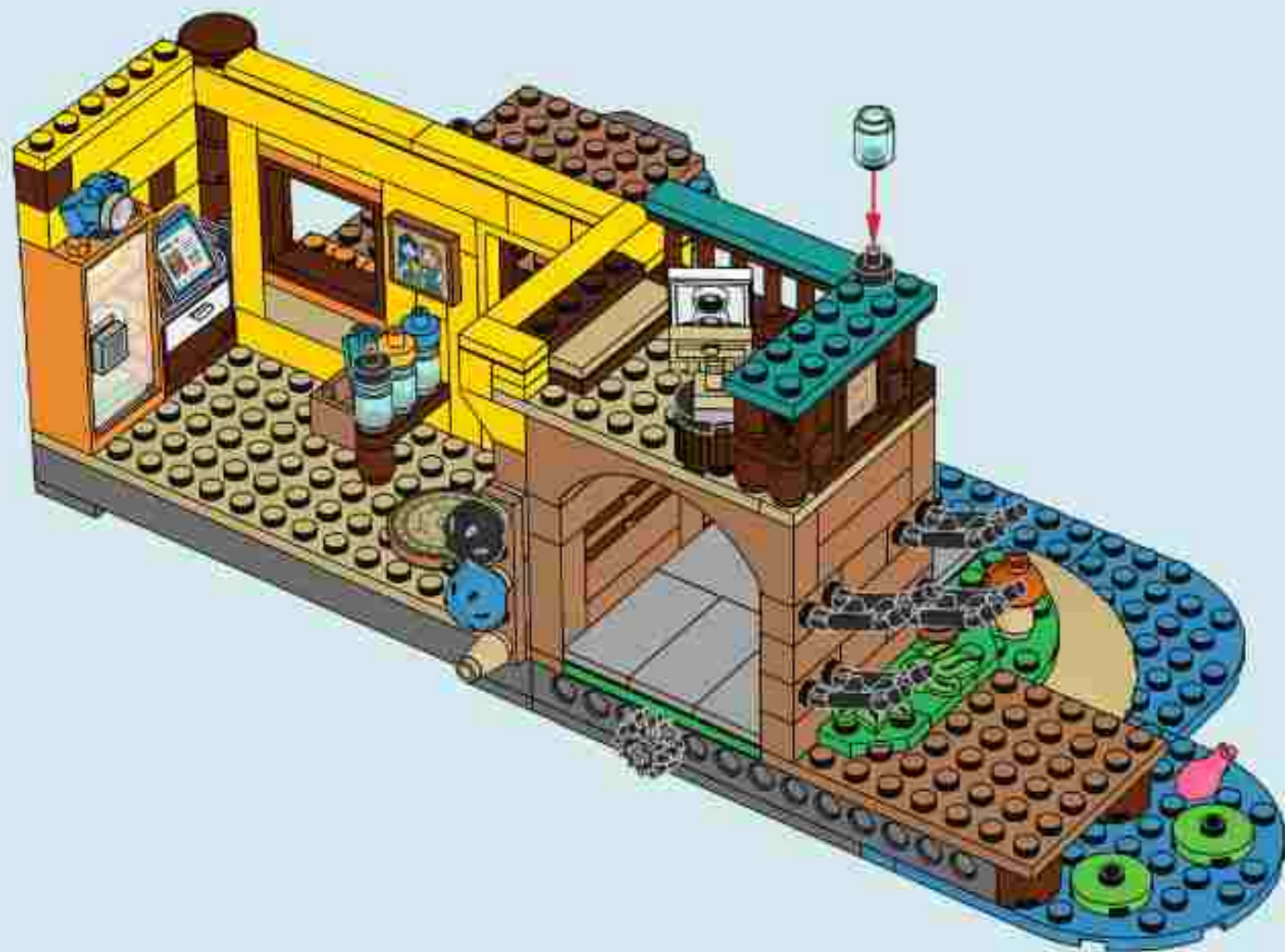





139

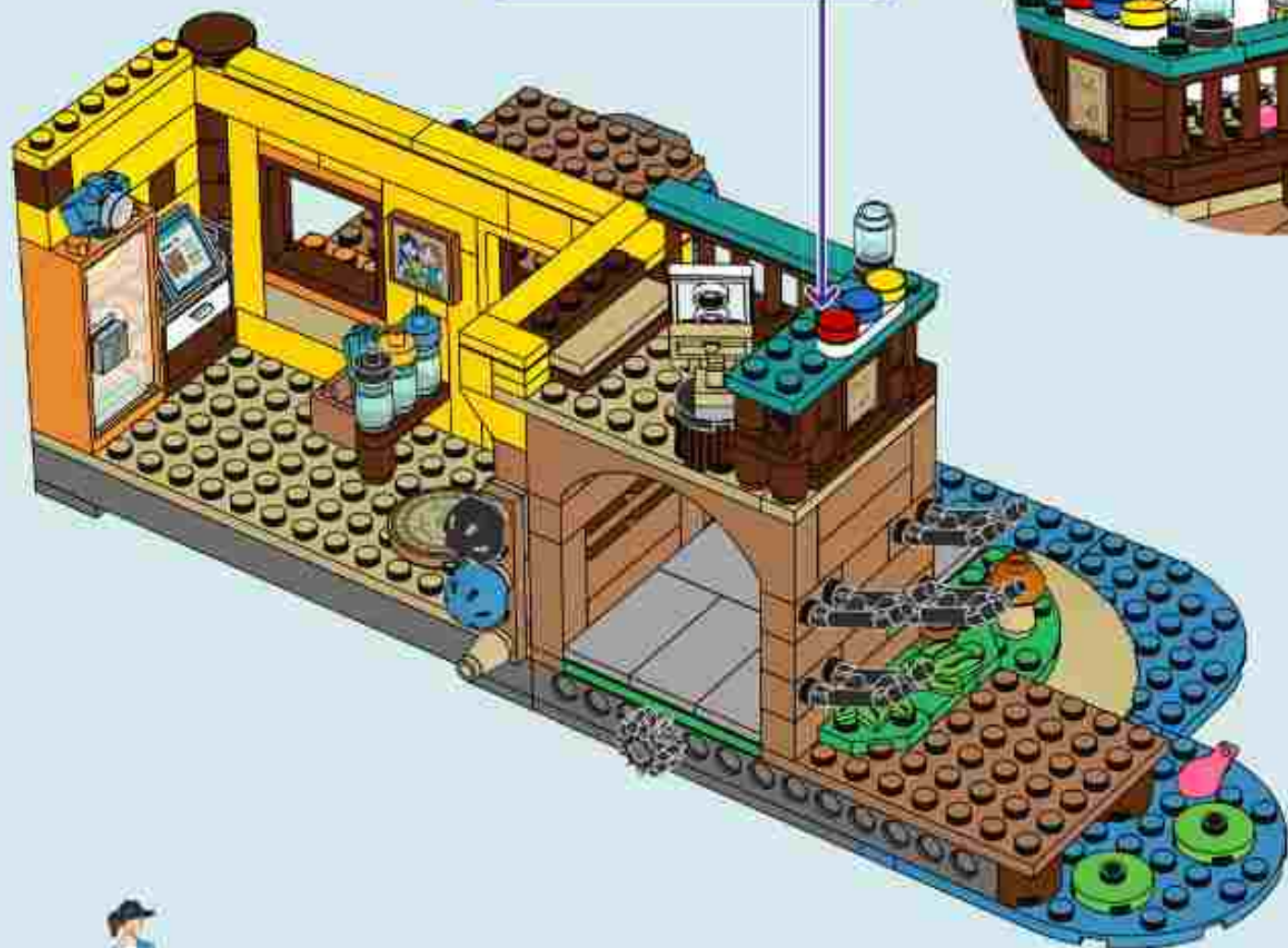
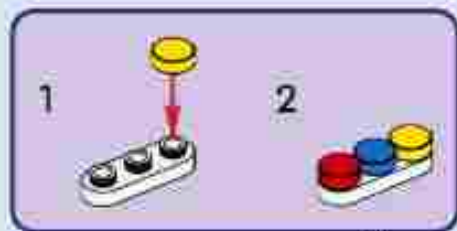



140

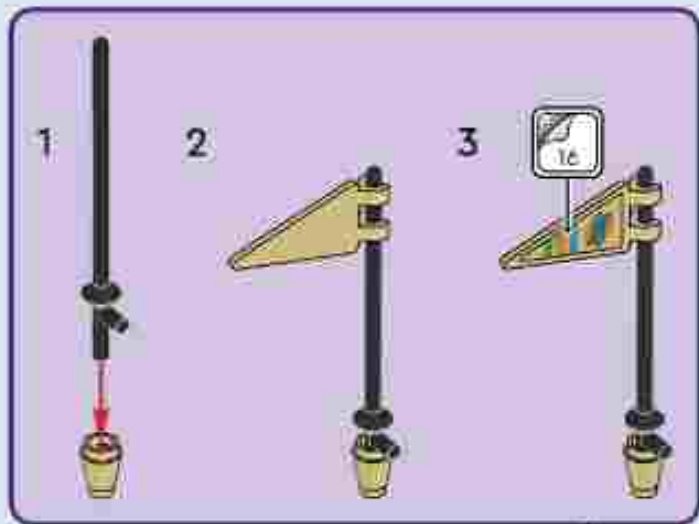





141





142





143

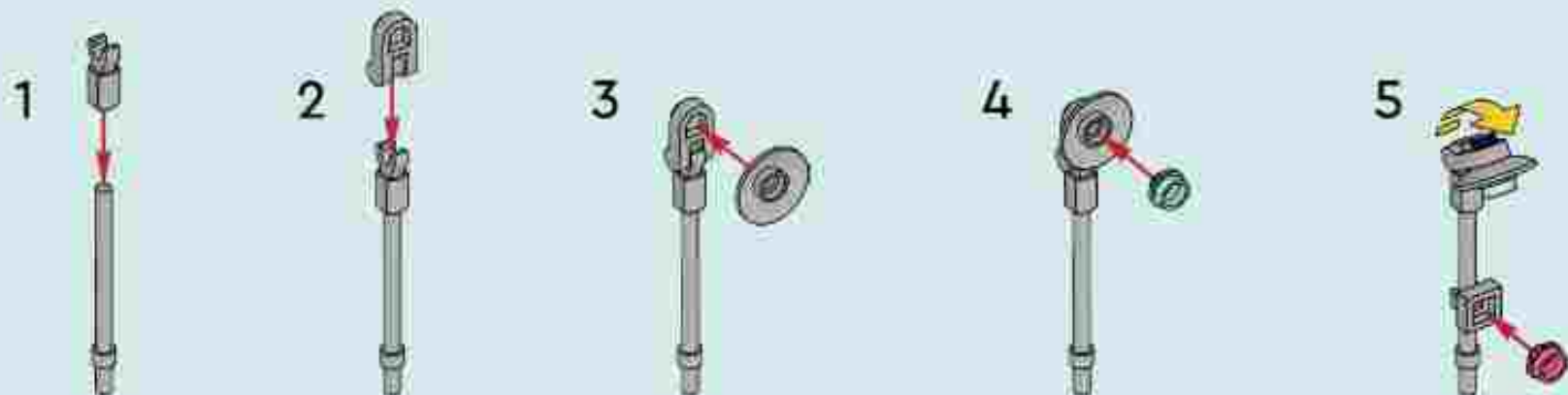









144





145







146





2x

147



2x





148



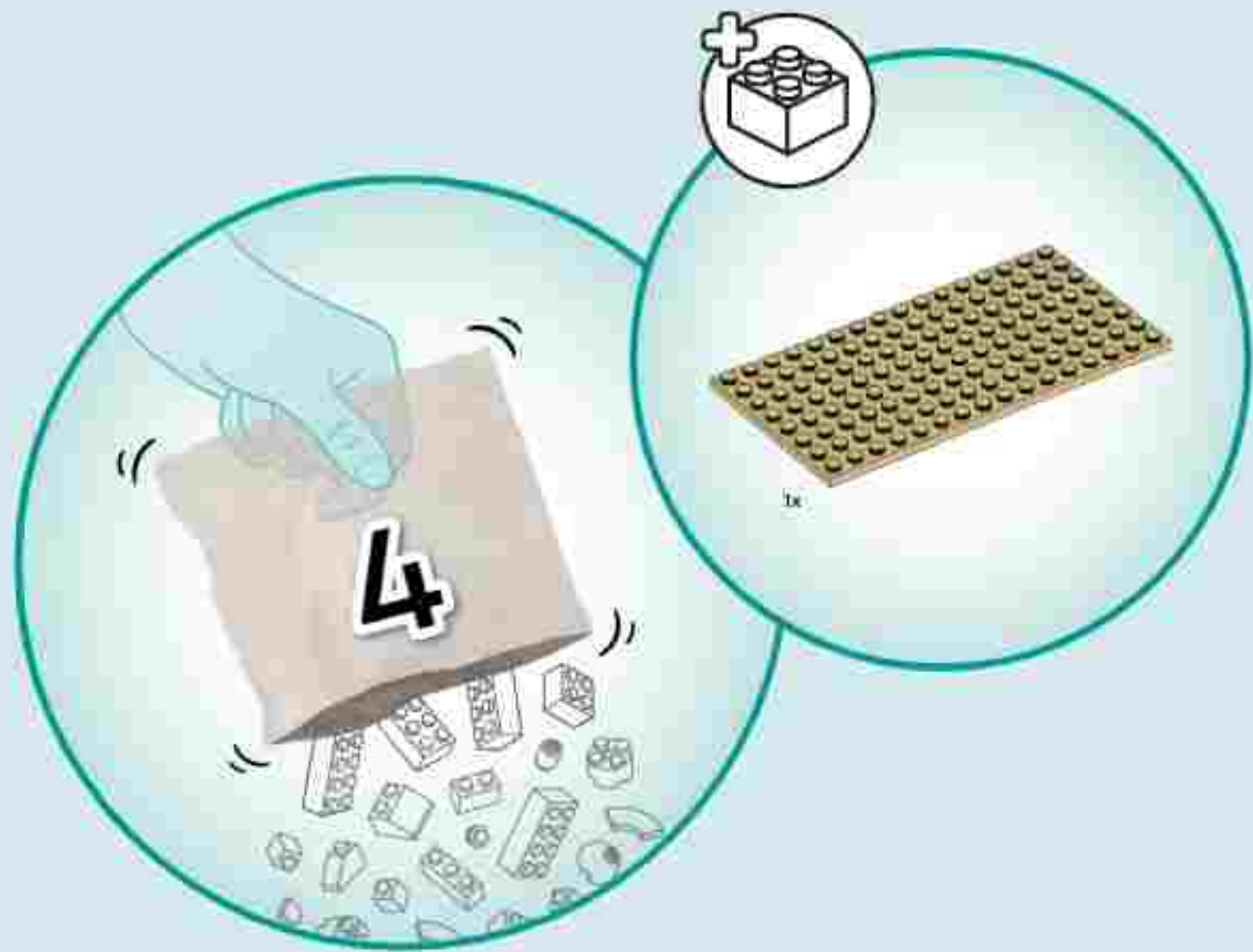

# ZAC





149

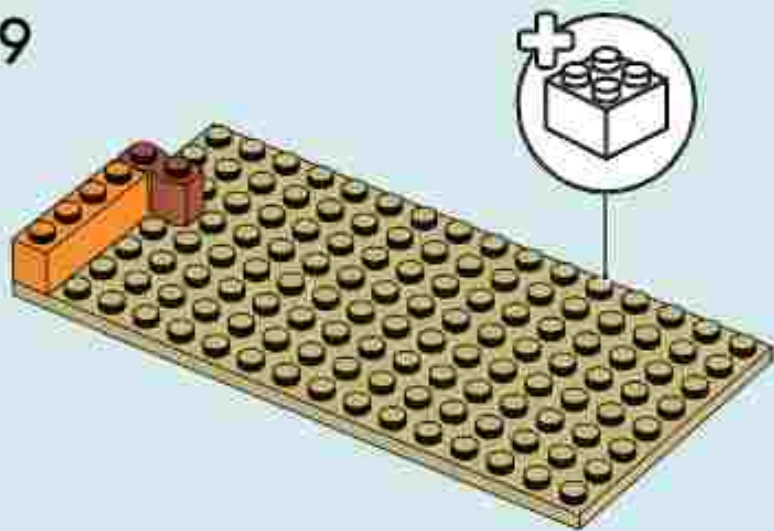

150

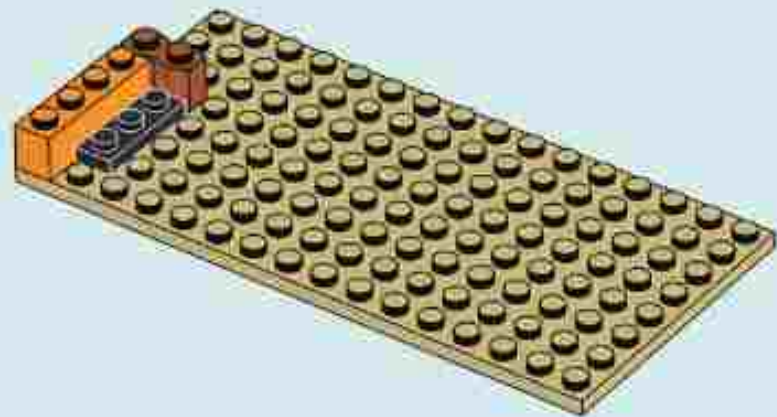





151

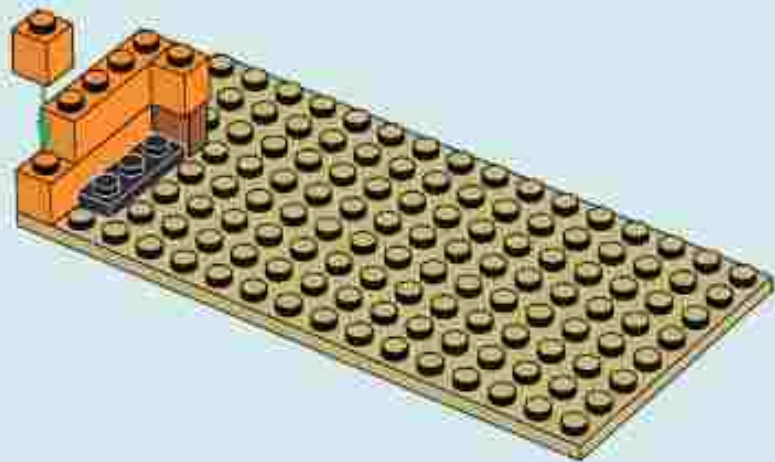

152

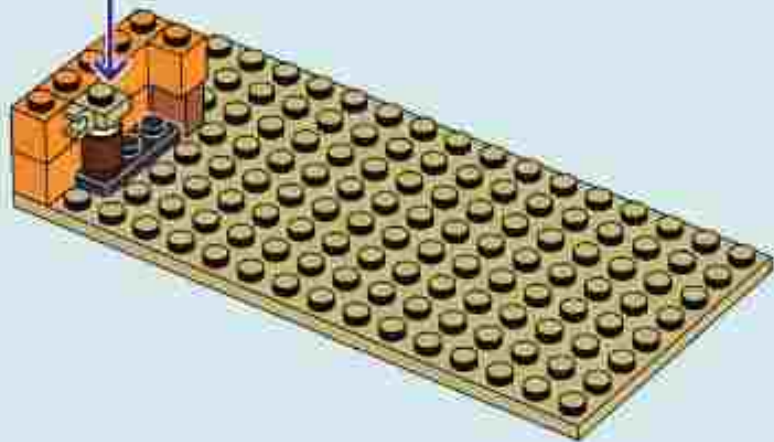

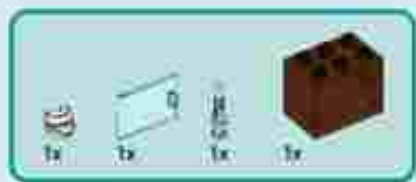

153

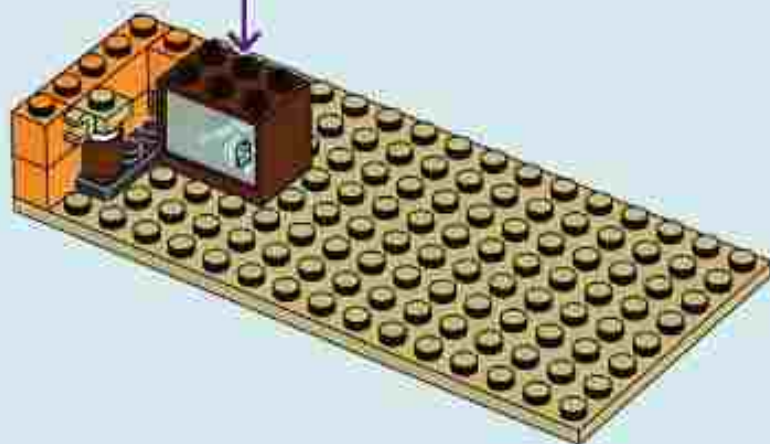



154



155





156



157





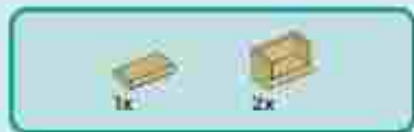

158



159

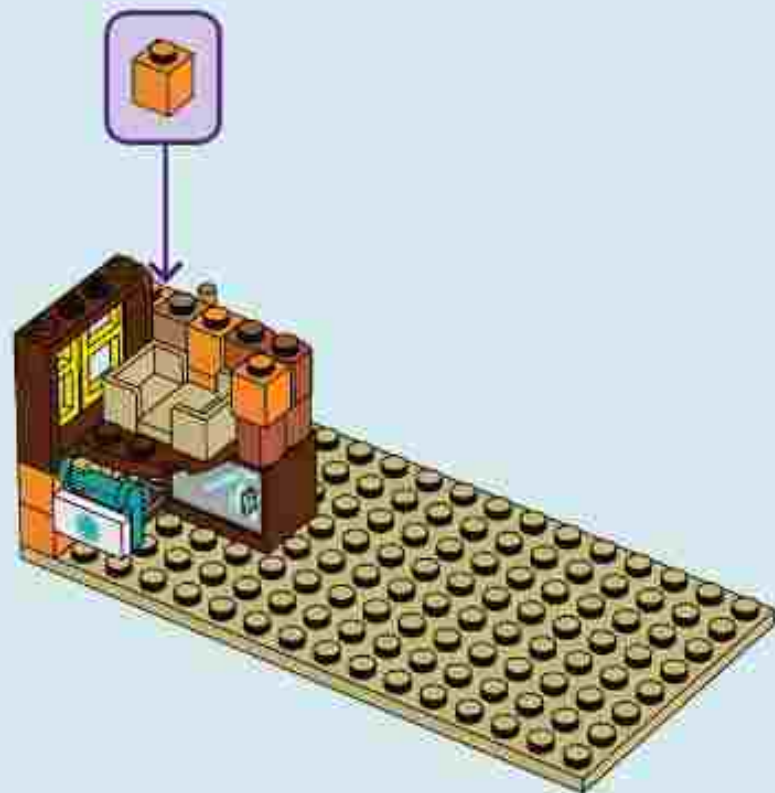



160





161

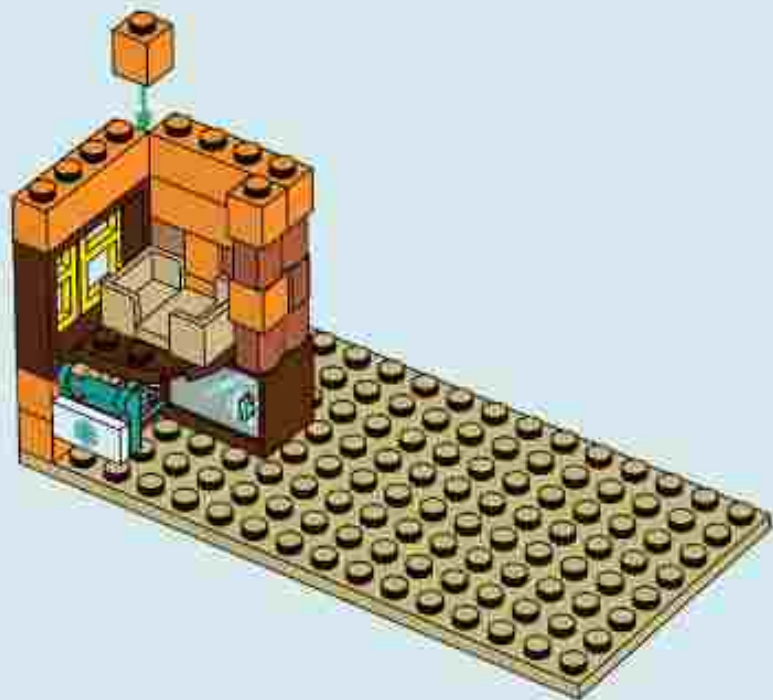

162

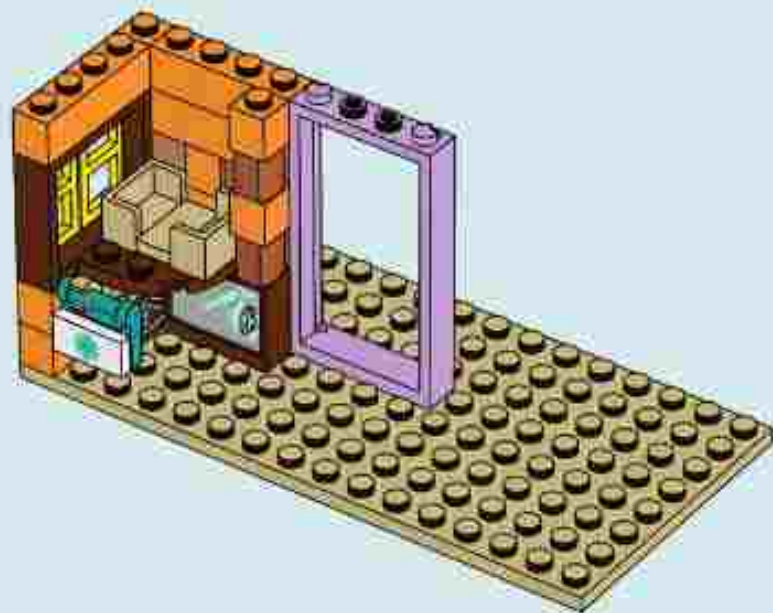



163

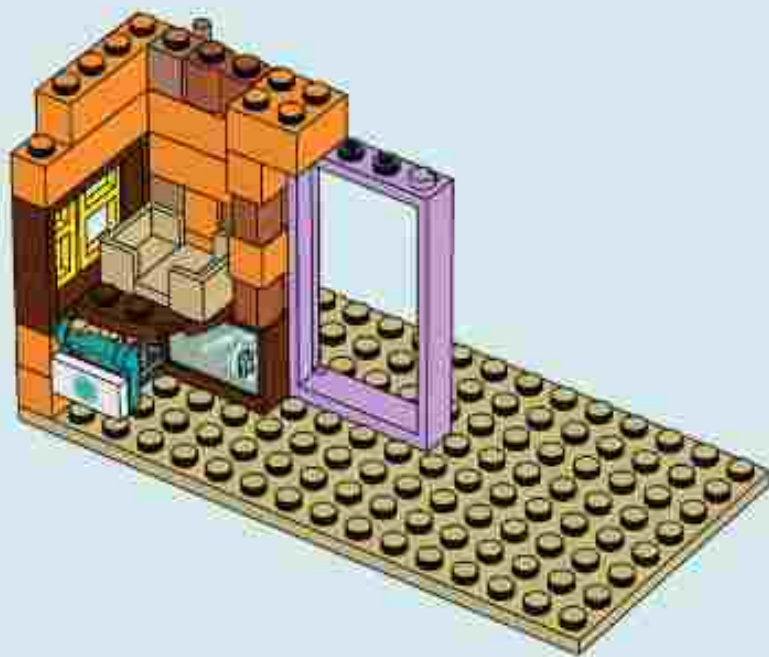



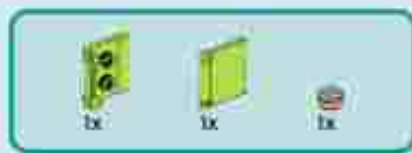

164

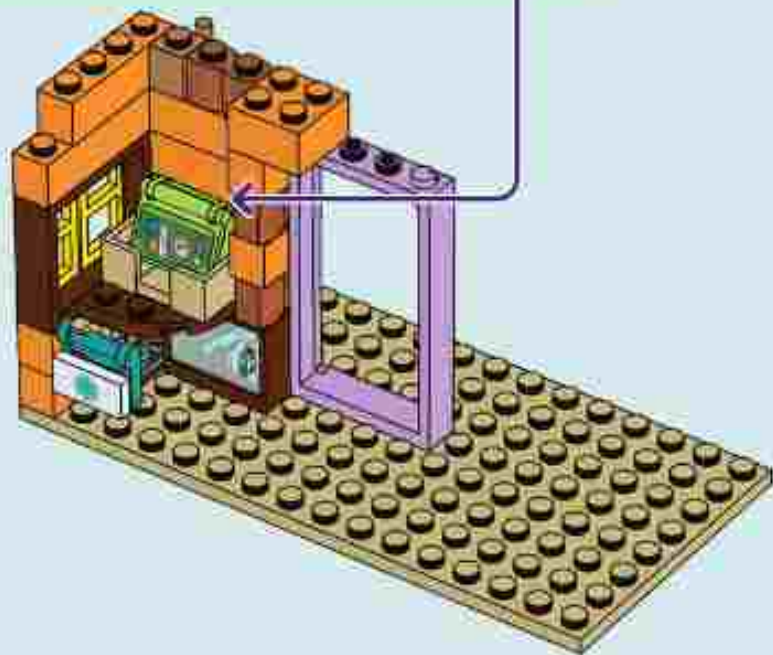
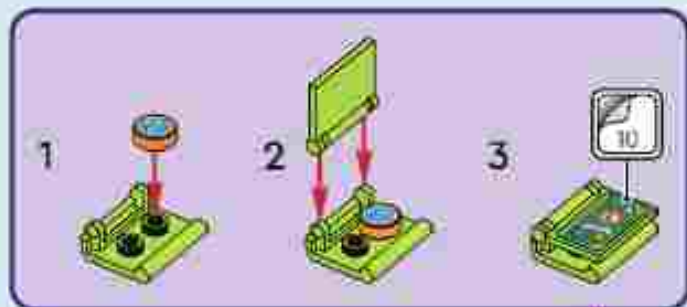

165

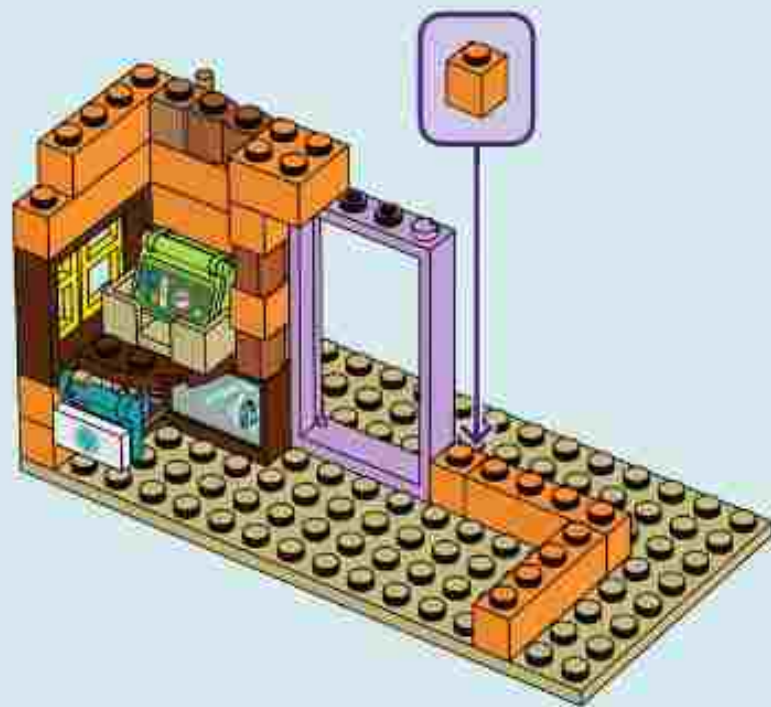



4x

166

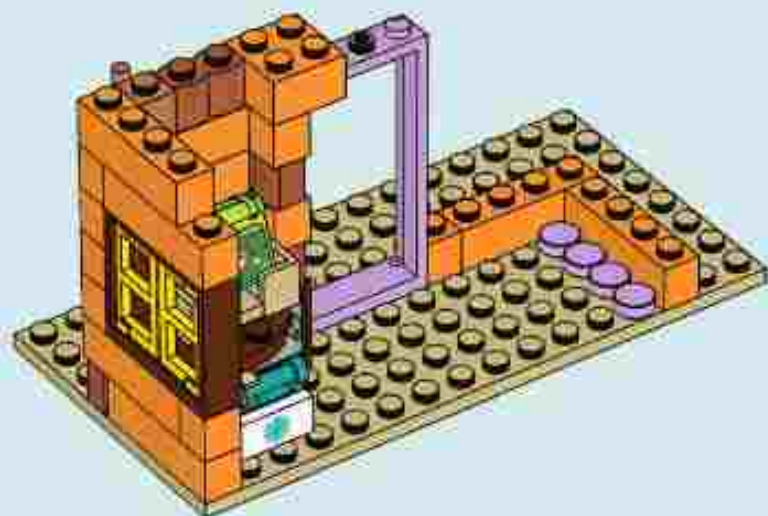

1x



1x



2x

167

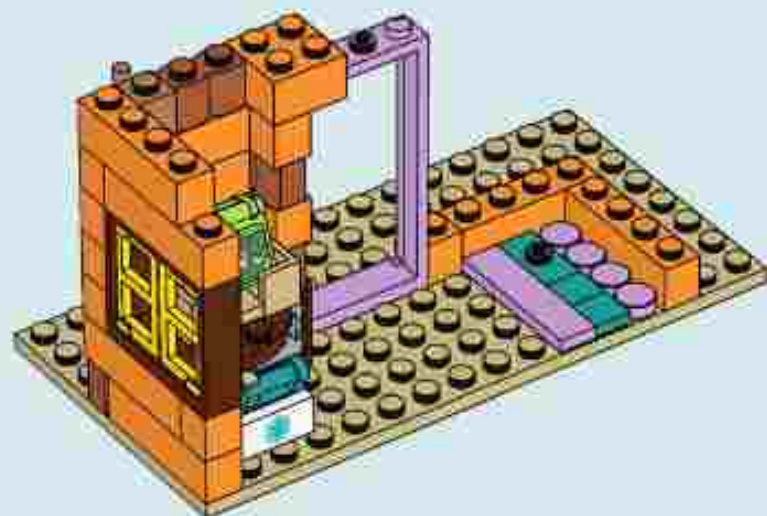



168

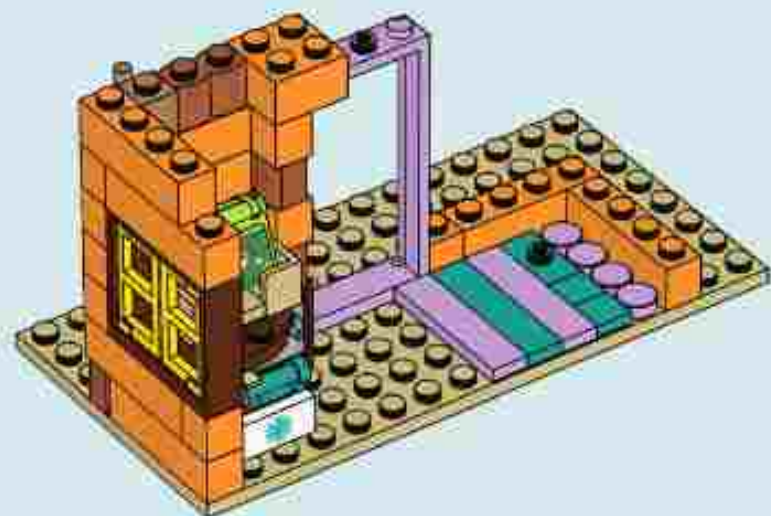

169

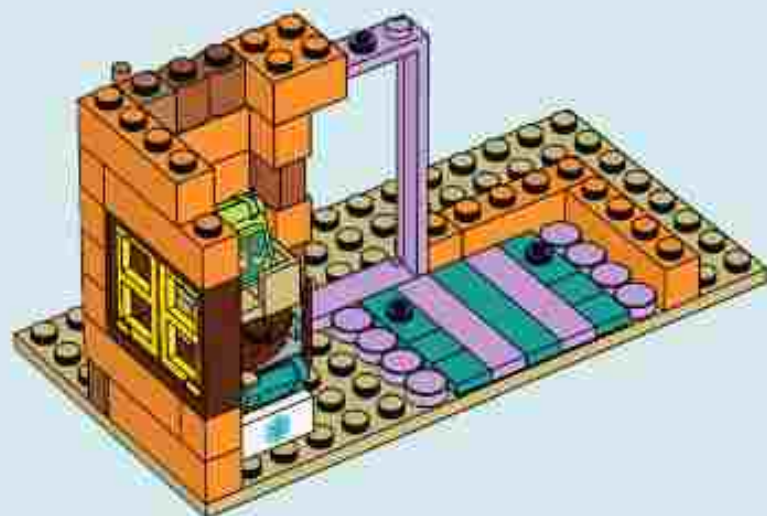



170

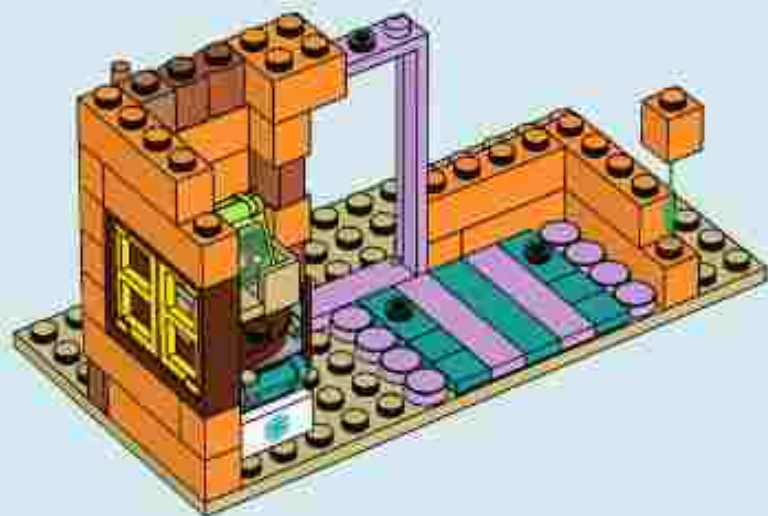

171

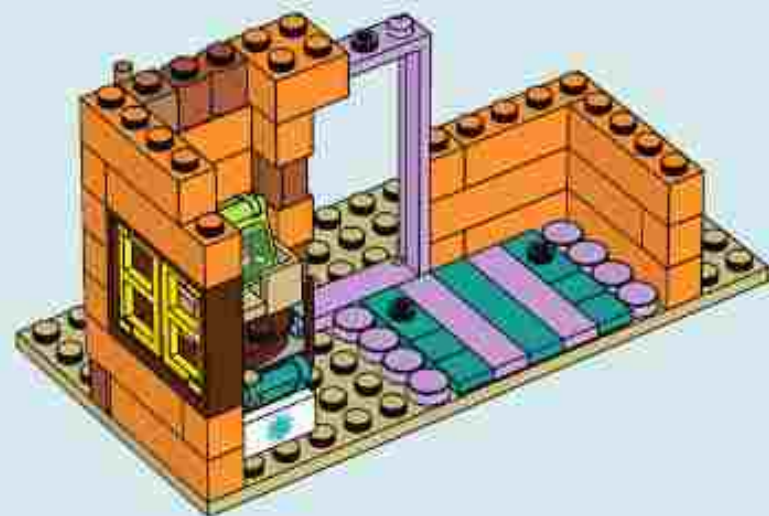





172

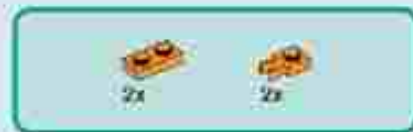
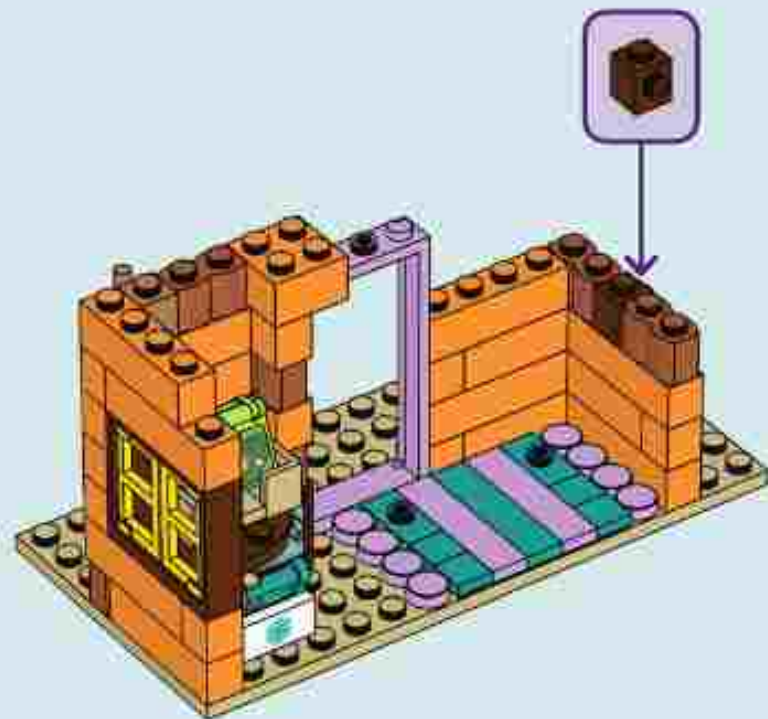

173

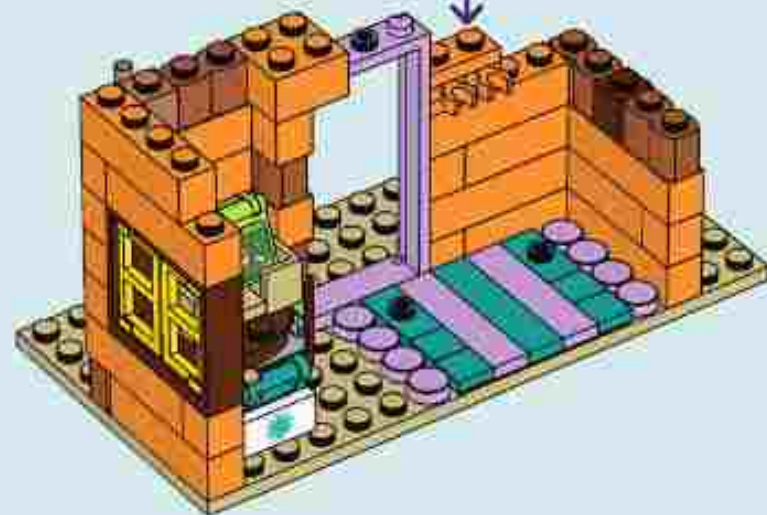
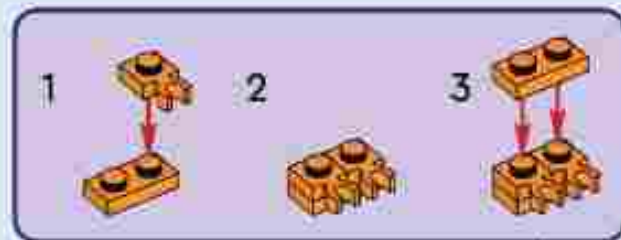



174

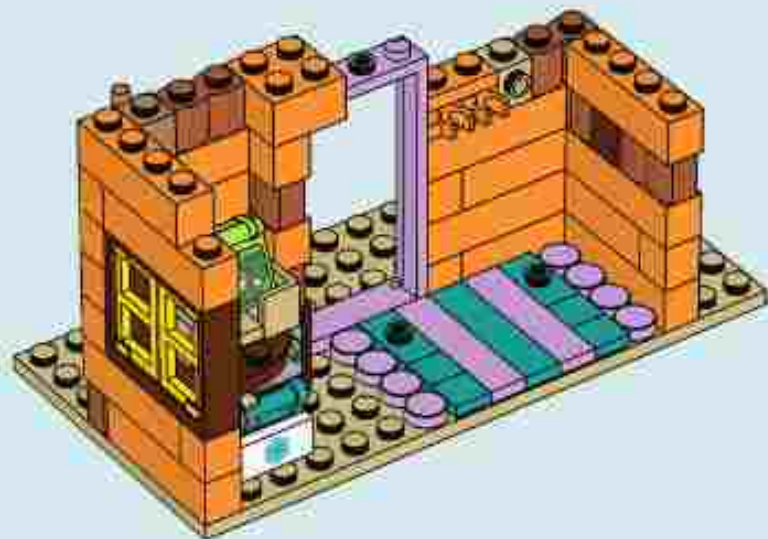

175

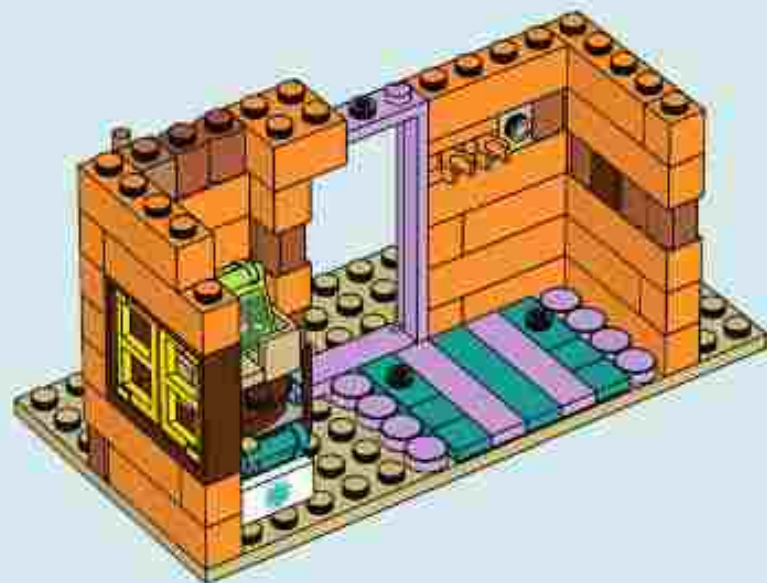



176

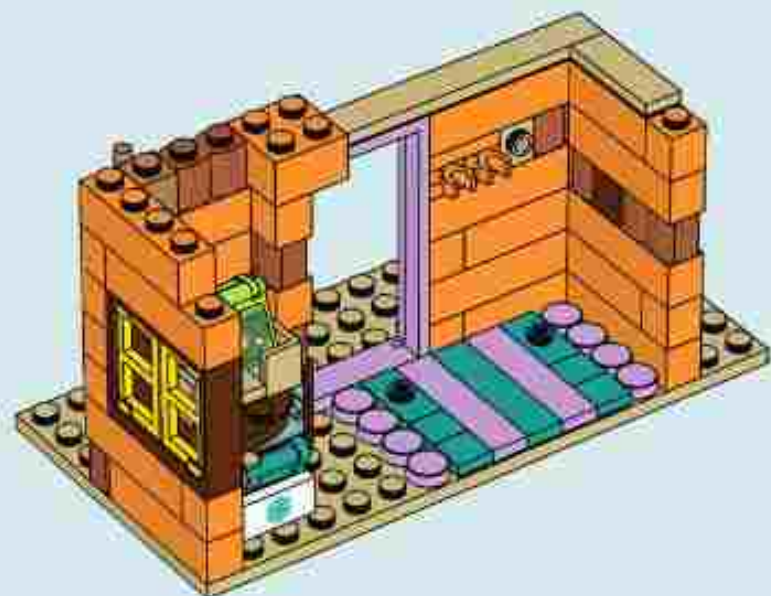

177

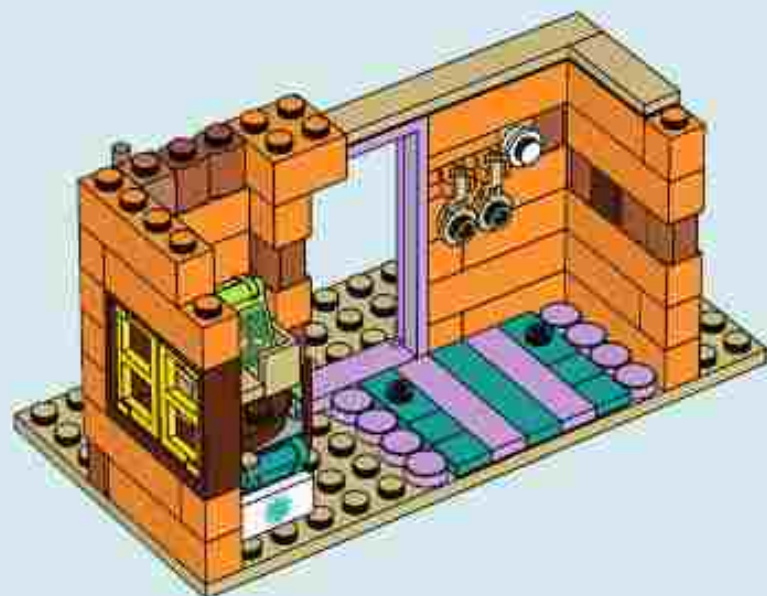

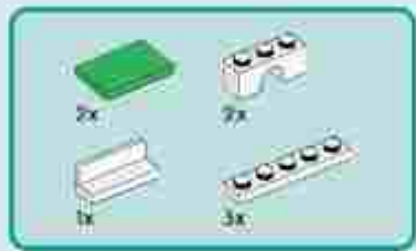

178

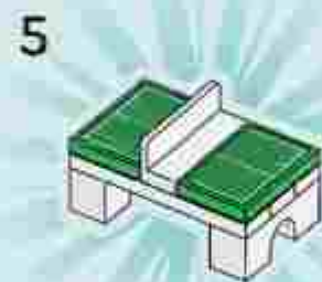
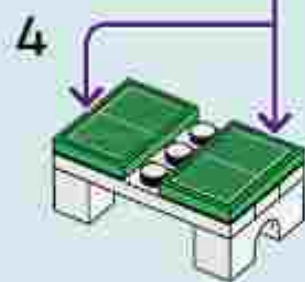
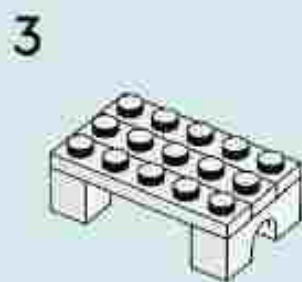
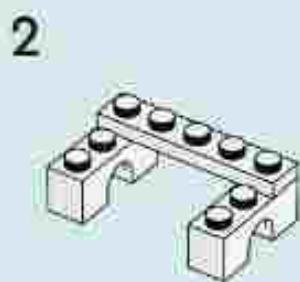
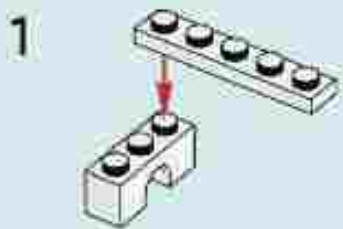
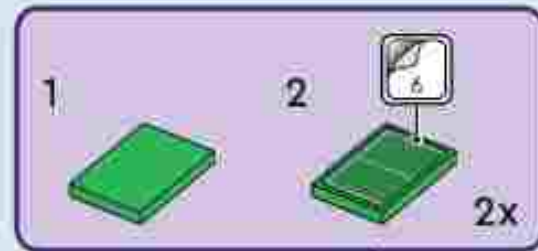





179

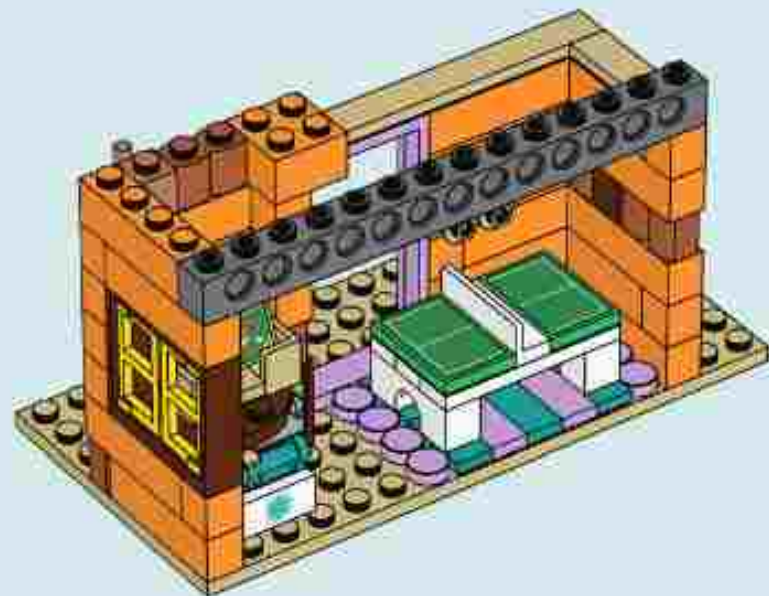
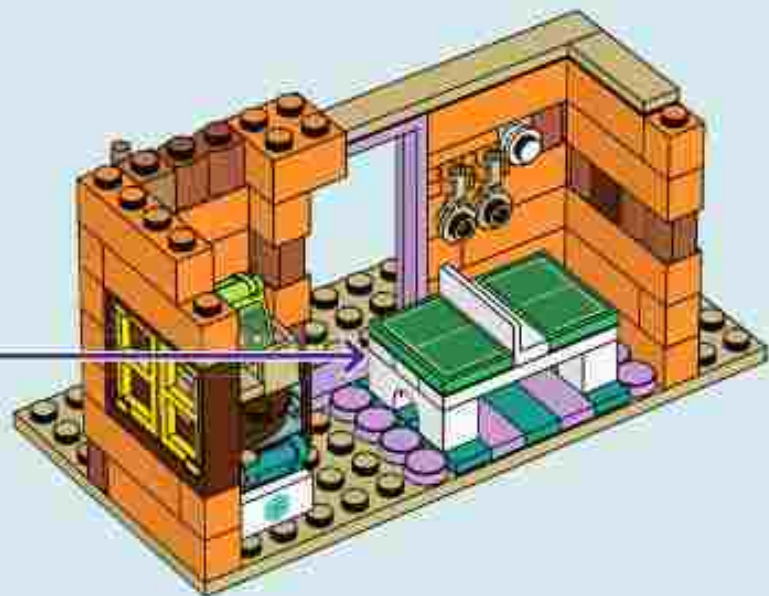

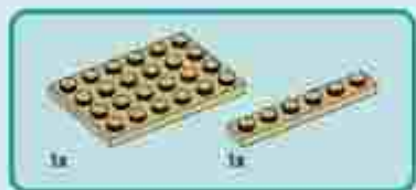

180

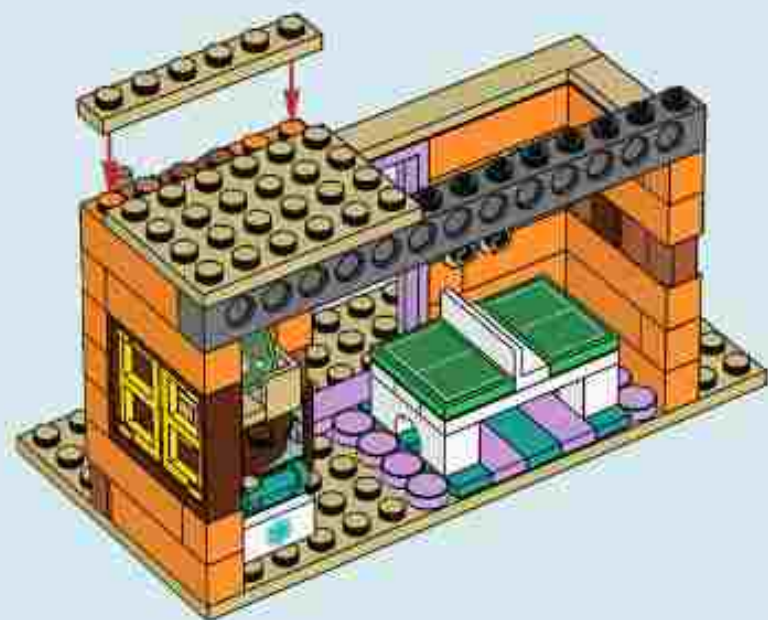

181

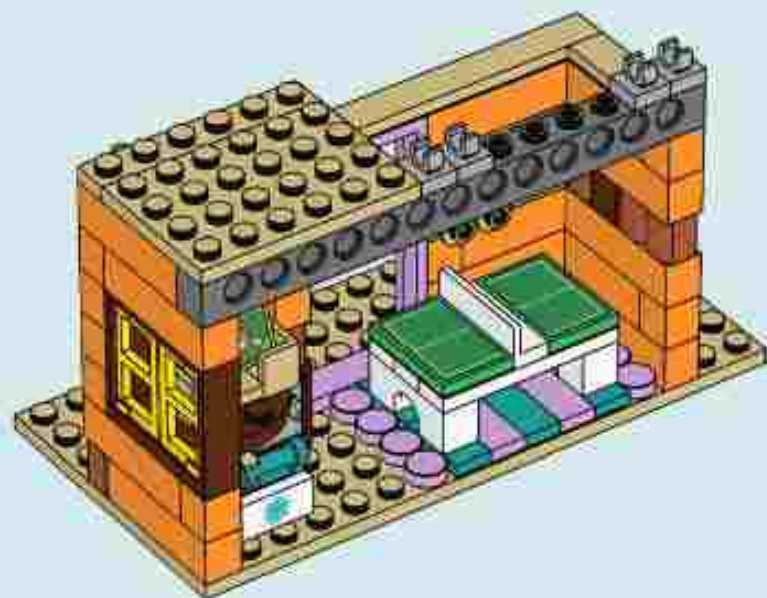



182

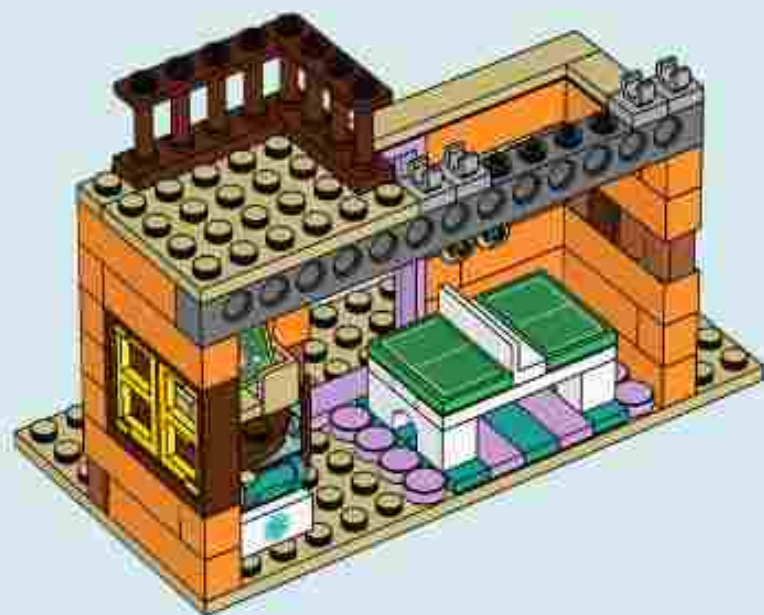

183

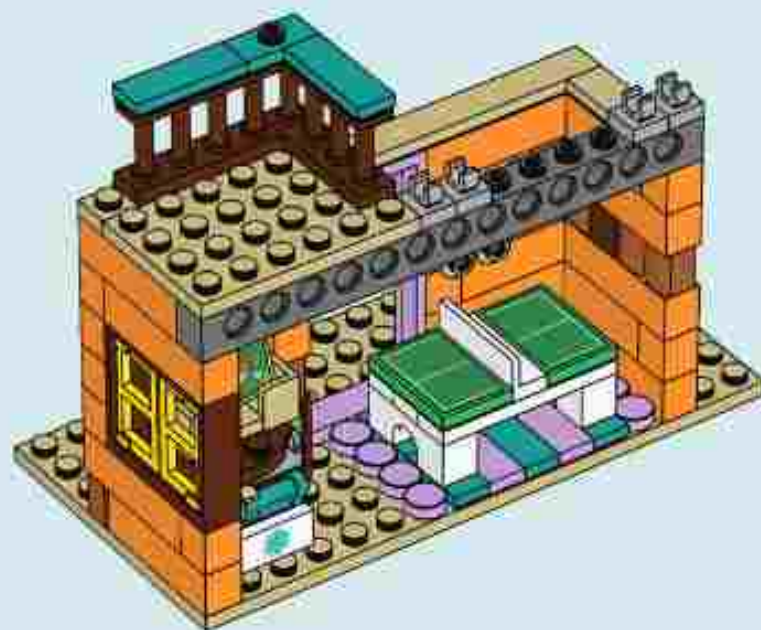





184

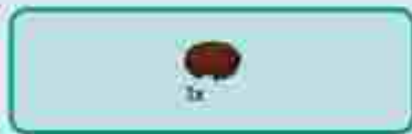
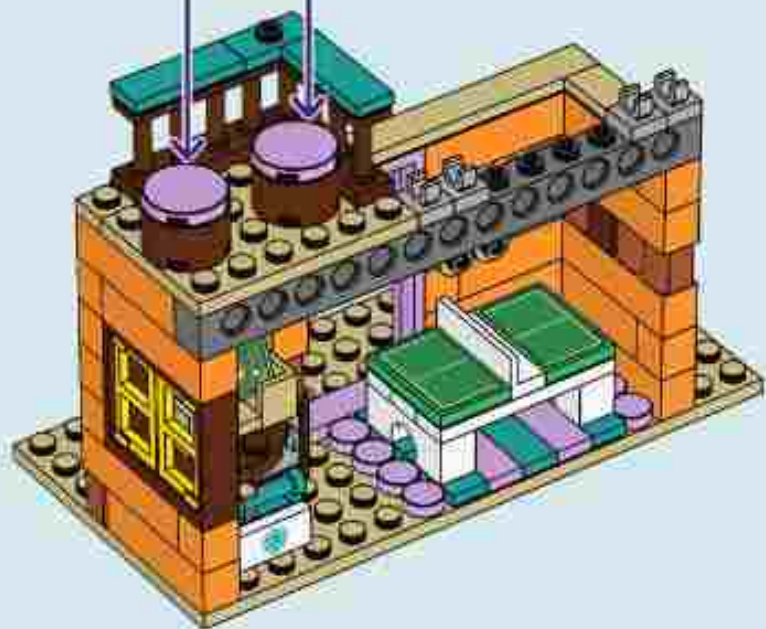

185

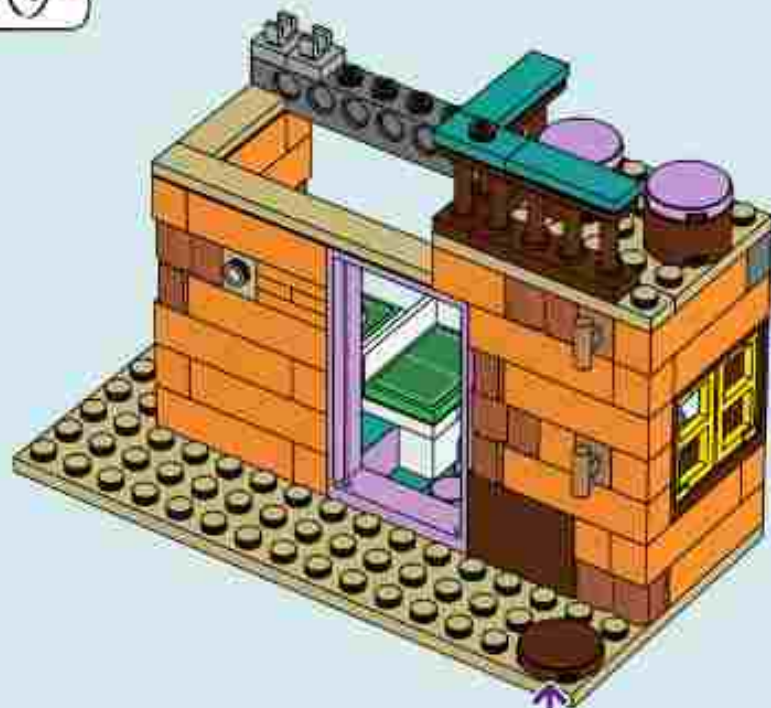



186









187





188







189





190

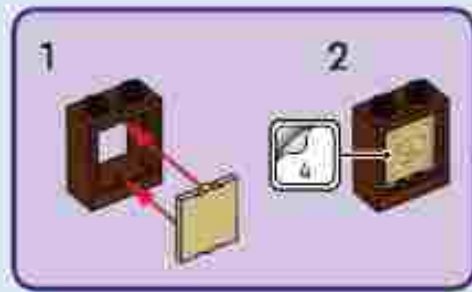



7x

191





192

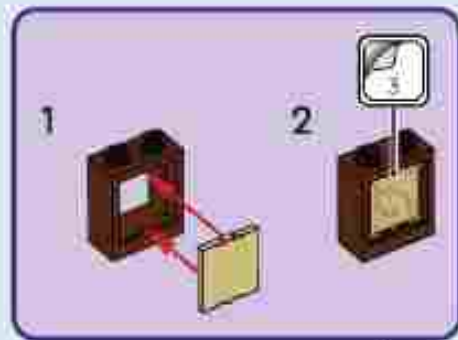





193



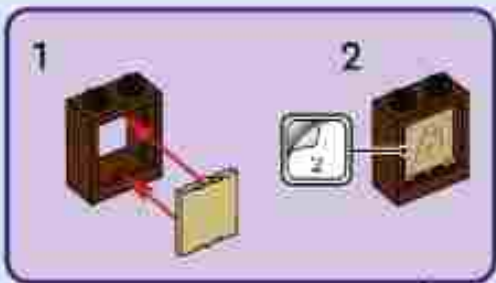

194





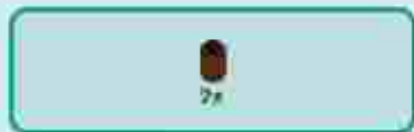

195





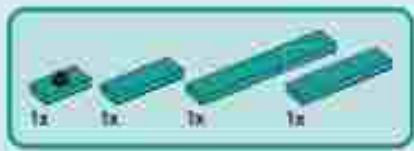

196





197











199

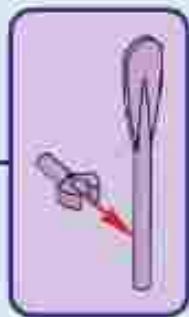

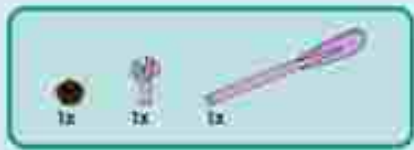

200

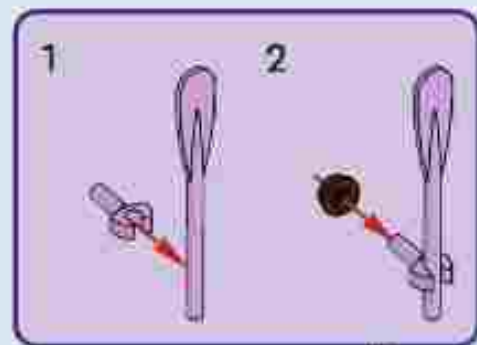





201

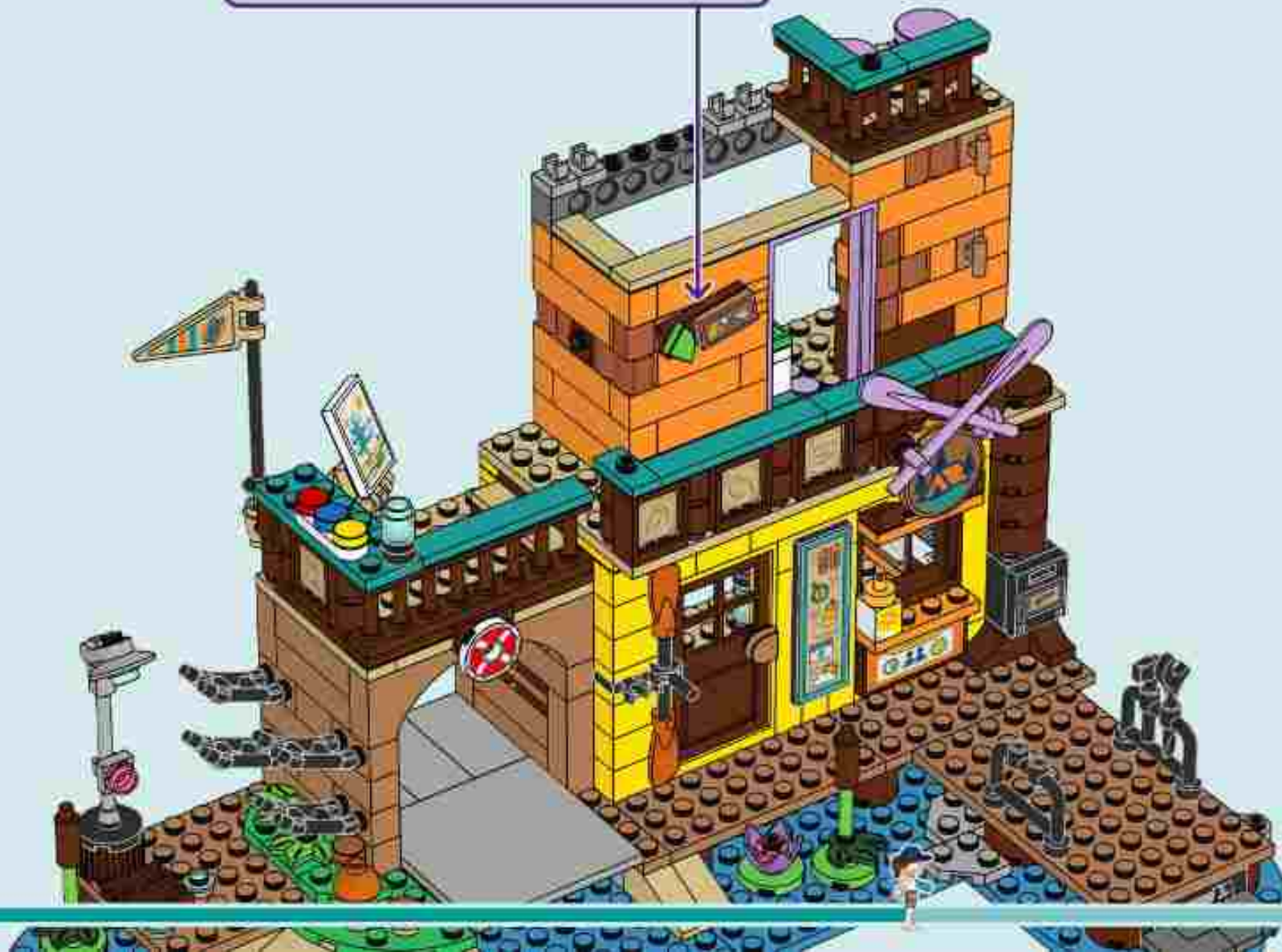





202





203

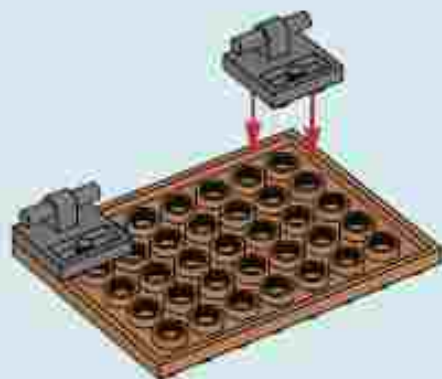

204



205





206



207









1x

209







210

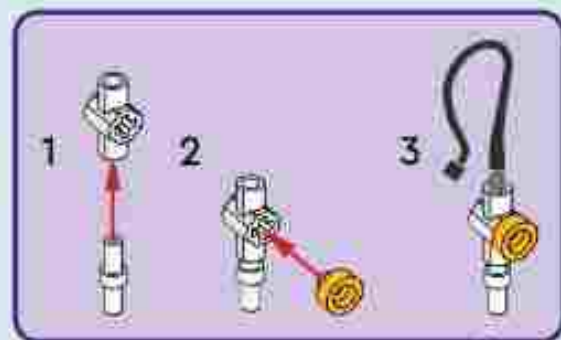





211



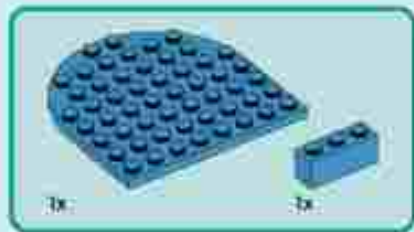

212

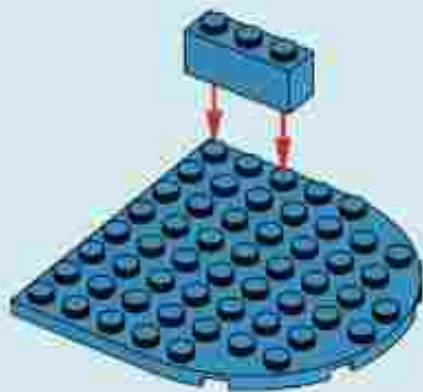

213

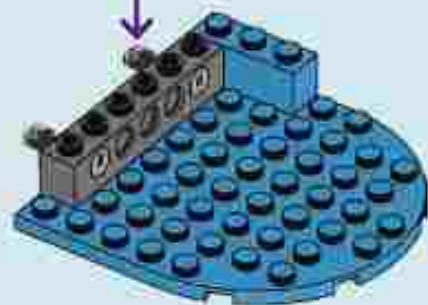

214

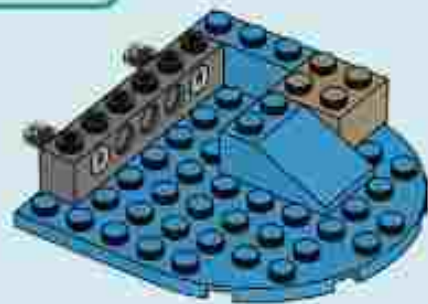



215



216

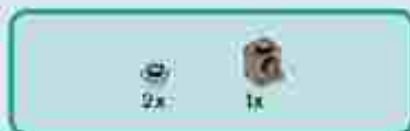
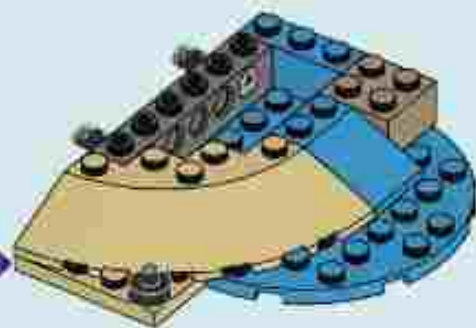

217

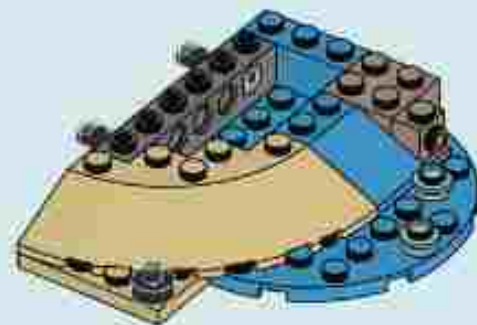

218

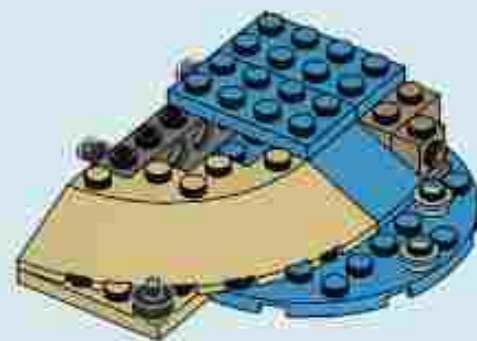





219

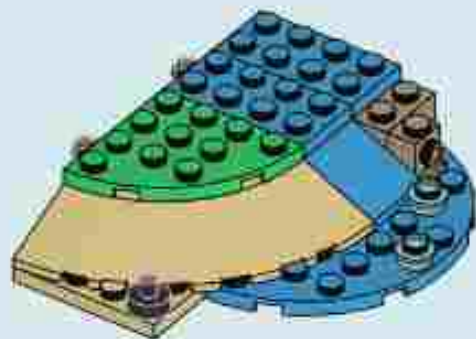

220

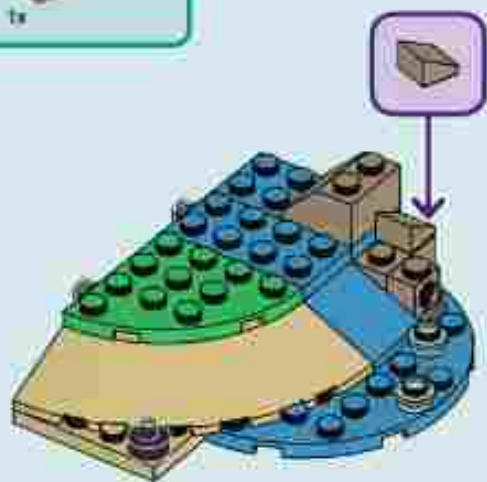

221

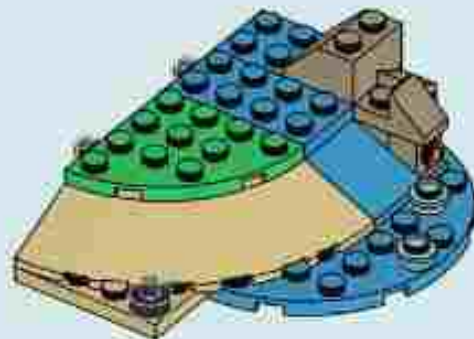

222





223

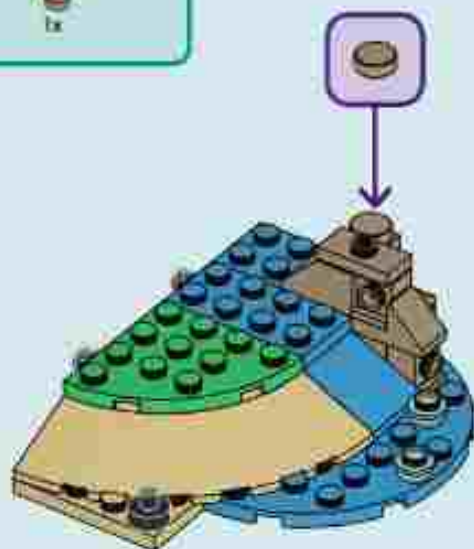

224

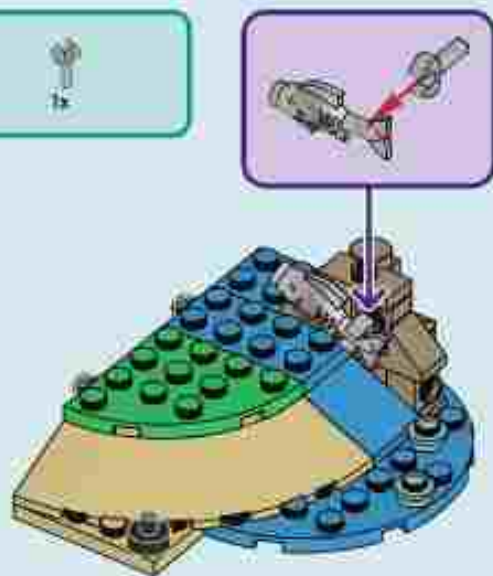

225

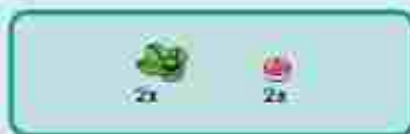
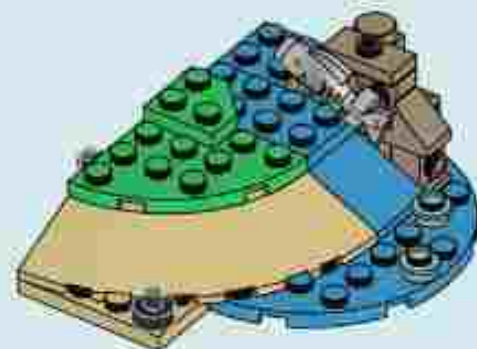

226

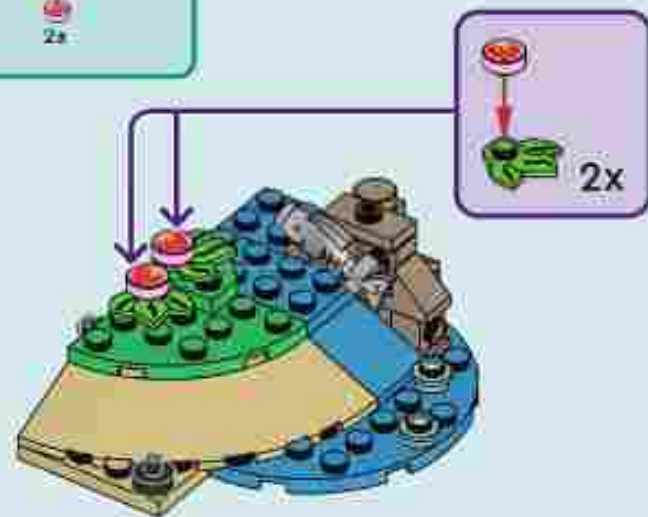



227

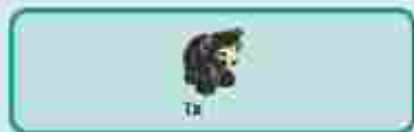

228



229





230







231

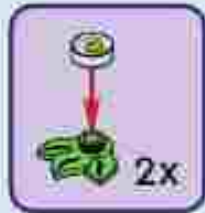





232







233



5



6



7



8



9



10









234

1



2



3



4



5



6



7









235

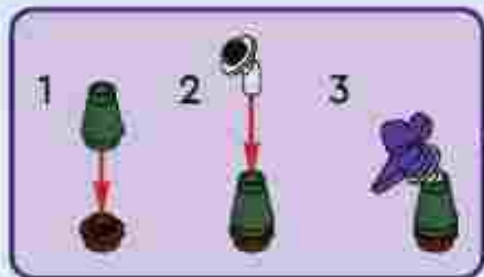









# Friends

WATCH SERIES  
ONLINE

REGARDEZ  
LA SÉRIE EN LIGNE

MIRA LA SERIE  
EN INTERNET







# Friends



42624



42626



42622



42631





# Friends



NOVA

OLLY

ALIYA

PAISLEY

ZAC

LIANN

LEO

AUTUMN











YOU COULD **WIN**



Scan this QR code or go to **LEGO.COM/PRODUCTFEEDBACK** and give us your short feedback about this LEGO® set for a chance to win a cool LEGO prize.

Terms and Conditions apply\*



**EN: YOU COULD WIN.** Terms and Conditions apply\* **DE: Du könntest GEWINNEN.** Es gelten die Teilnahmebedingungen\* **FR: Tu pourrais GAGNER.** Des conditions s'appliquent\* **IT: Potresti VINCERE tu.** Termini e condizioni sono applicabili\* **ES: Puedes GANAR.** Aplican términos y condiciones\* **PT: Poderá GANHAR.** Aplicam-se termos e condições\* **ZH: 轻松获奖, 条款和条件适用\*** **PL: Szansa na WYGRANĄ.** Obowiązują warunki korzystania\* **CS: Máte šanci VYHRÁT.** Platí všeobecné smluvní podmínky\* **SK: Máte šancu VYHRAŤ.** Platia všeobecné zmluvné podmienky\* **HU: TE IS NYERHETSZ.** Felhasználási feltételek érvényesek\* **RO: Ai putea CÂȘTIGA.** Se aplică termenii și condiții\* **BG: Можете да СПЕЧЕЛИТЕ.** Има определени правила и условия\* **LV: Tu vari LAIMĒT.** Ir spēkā noteikumi un nosacījumi.\* **ET: Sul on võimalus VÕITA.** Kehtivad tingimused\* **LT: Jūs galite LAIMĖTI.** Taikomos sąlygos\*

\*[LEGO.com/productfeedback-terms](https://www.lego.com/productfeedback-terms)