

NICA

UAB „Rubineta“
Savanorių pr. 180, LT-03154 Vilnius
www.rubineta.com

COMPANY WITH
QUALITY SYSTEM
CERTIFIED BY DNV GL
= ISO 9001 =

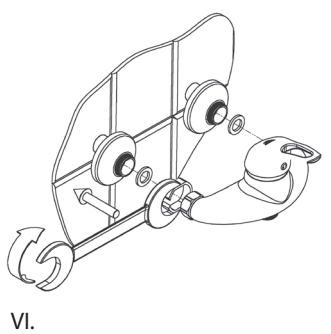
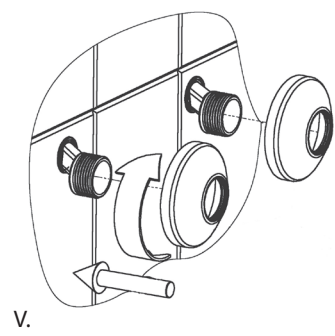
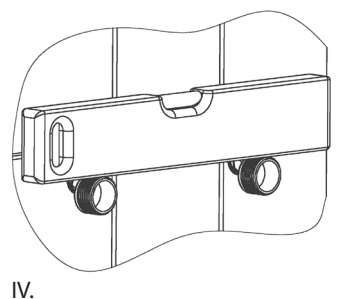
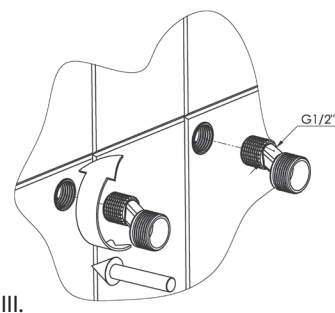
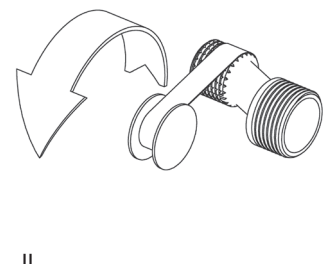
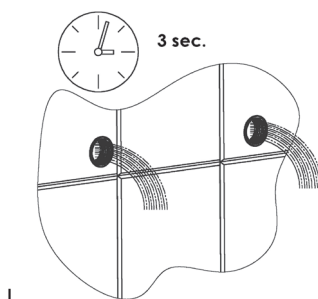
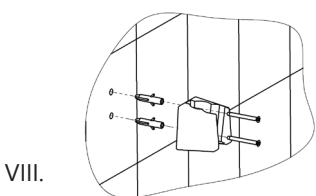
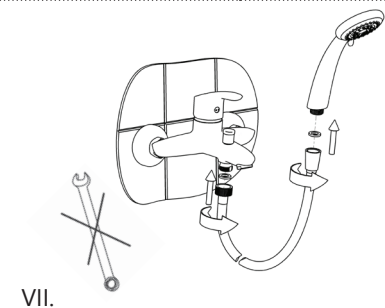
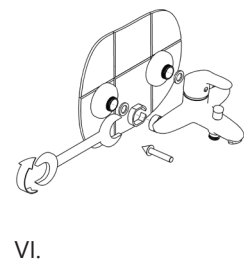
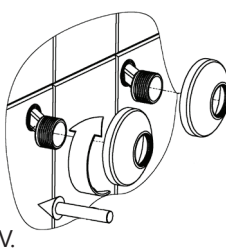
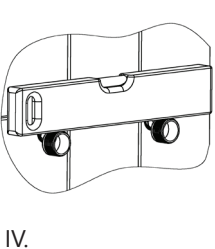
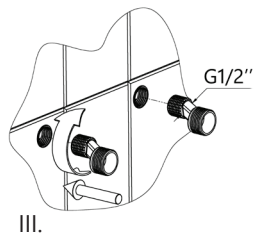
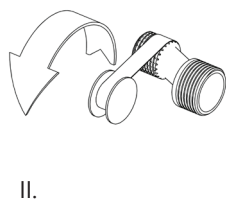
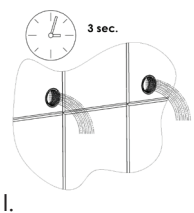

Nica-11/C

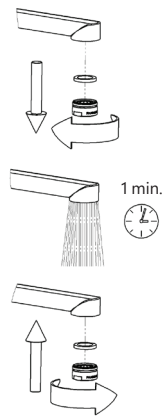
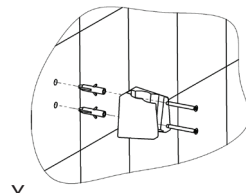
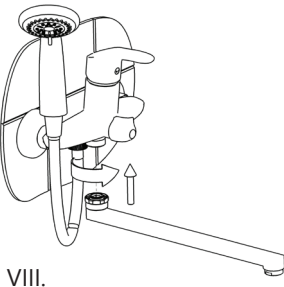
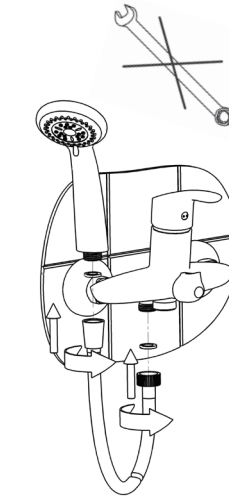
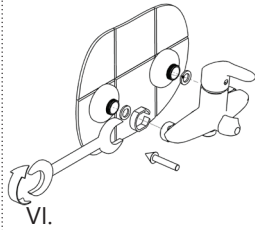
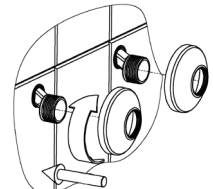
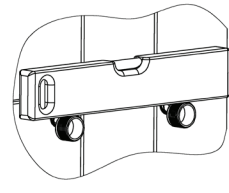
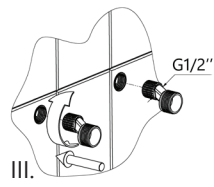
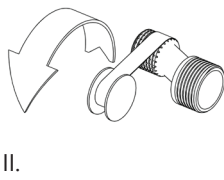
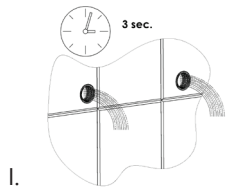

Nica-12/K

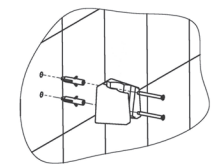
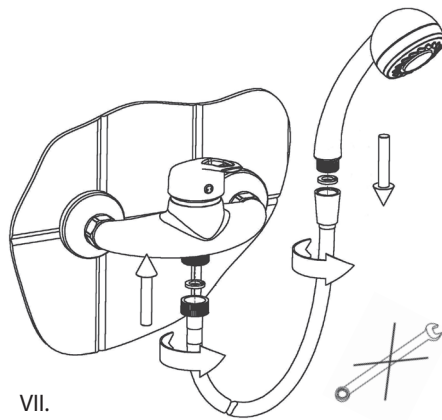
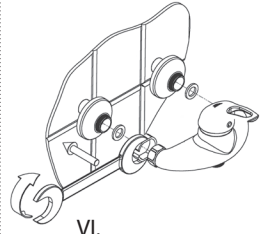
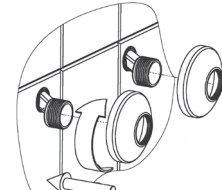
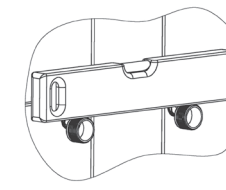
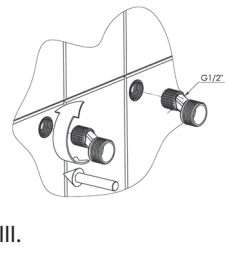
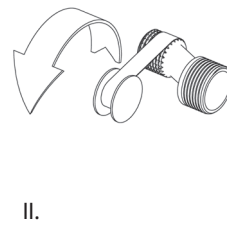
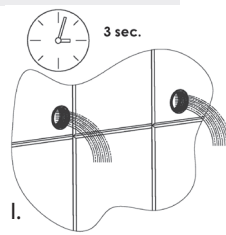

Nica-18

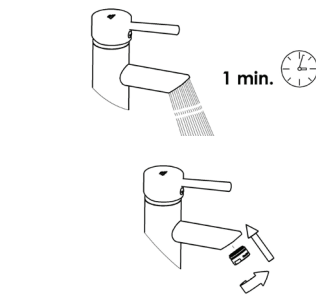
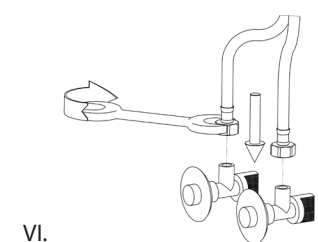
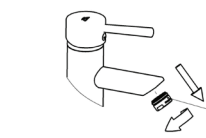
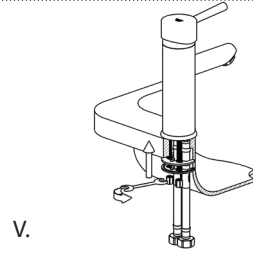
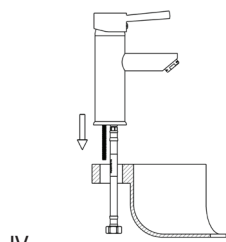
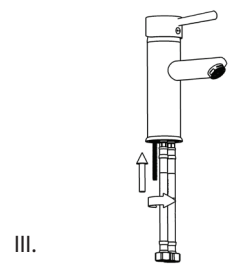
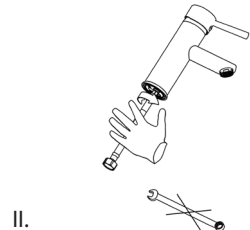
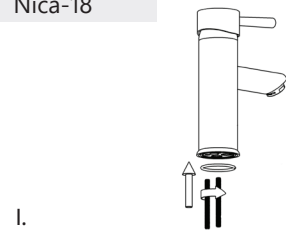

Nica-18/D

