

I

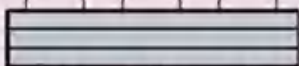

3

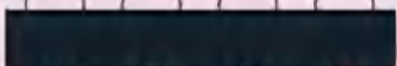

4

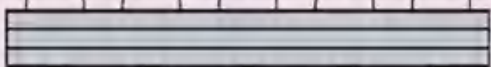

5

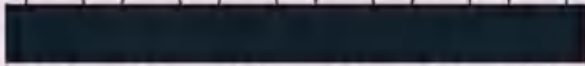

6

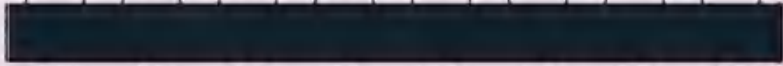

8



0 1 2 3 4 5 6 7 8 9 10 11 12 13 14 15 16



**II**

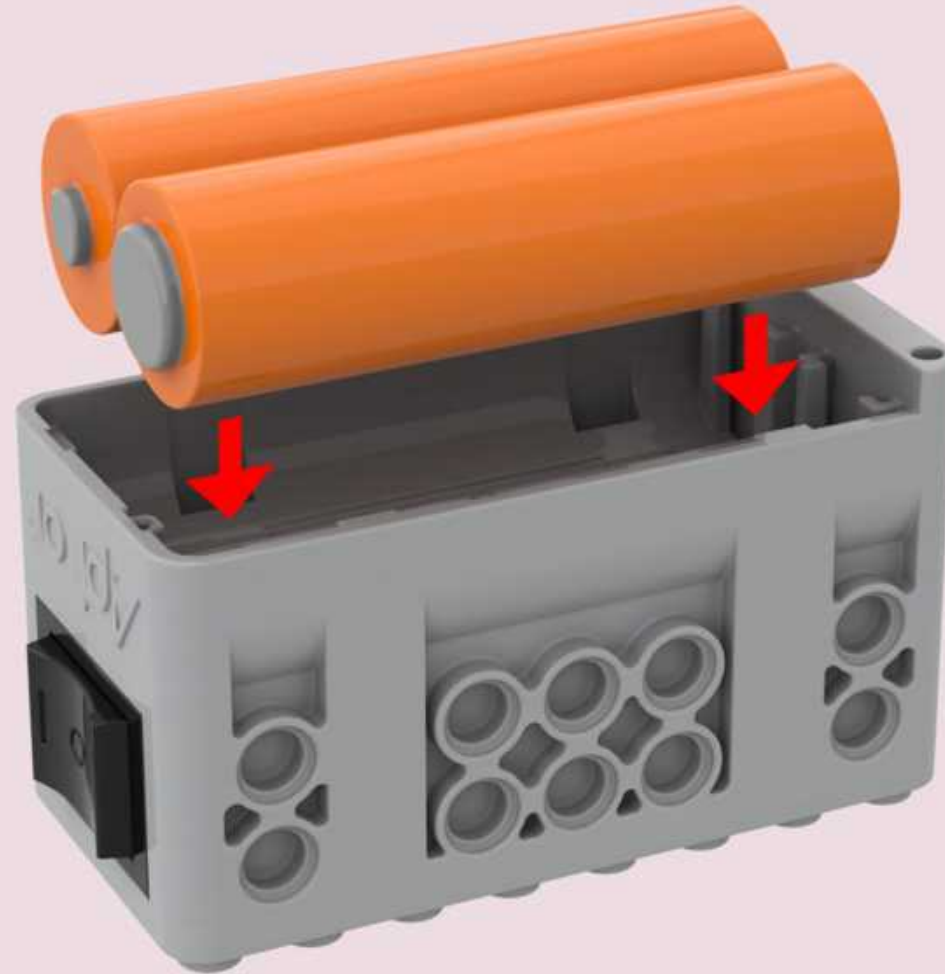

**AA x2**

# 1

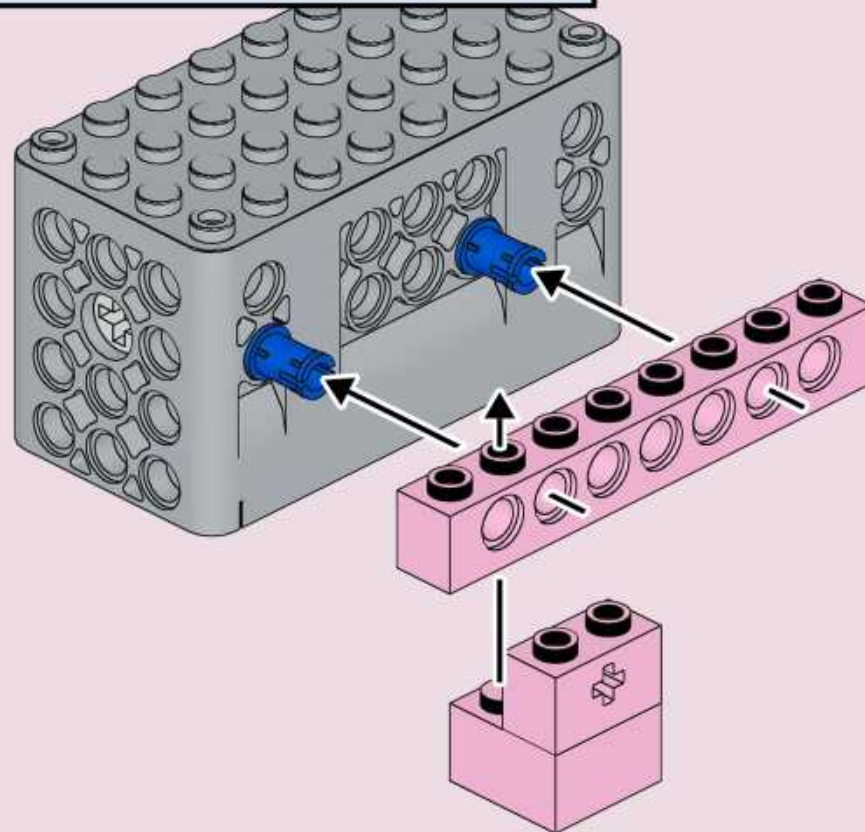
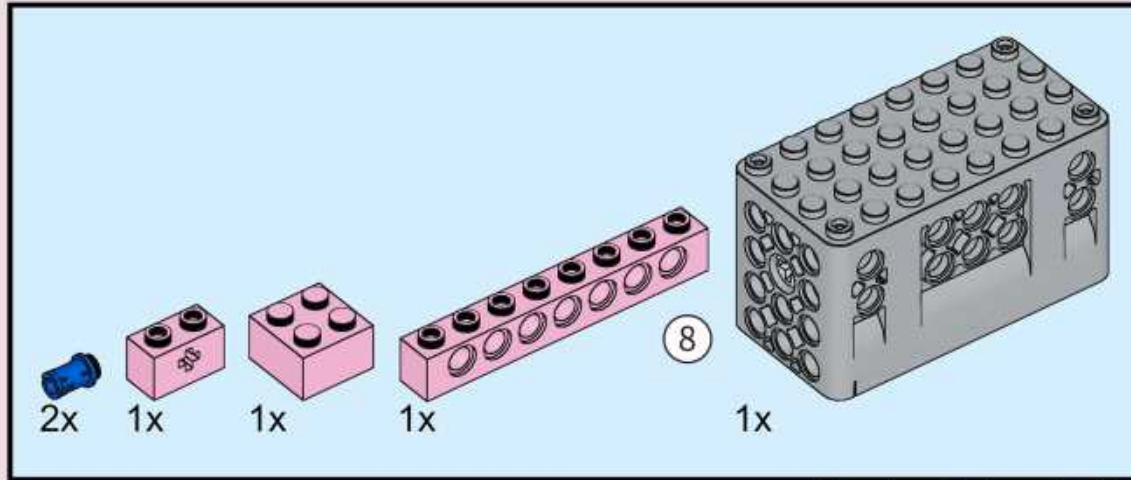



# 2

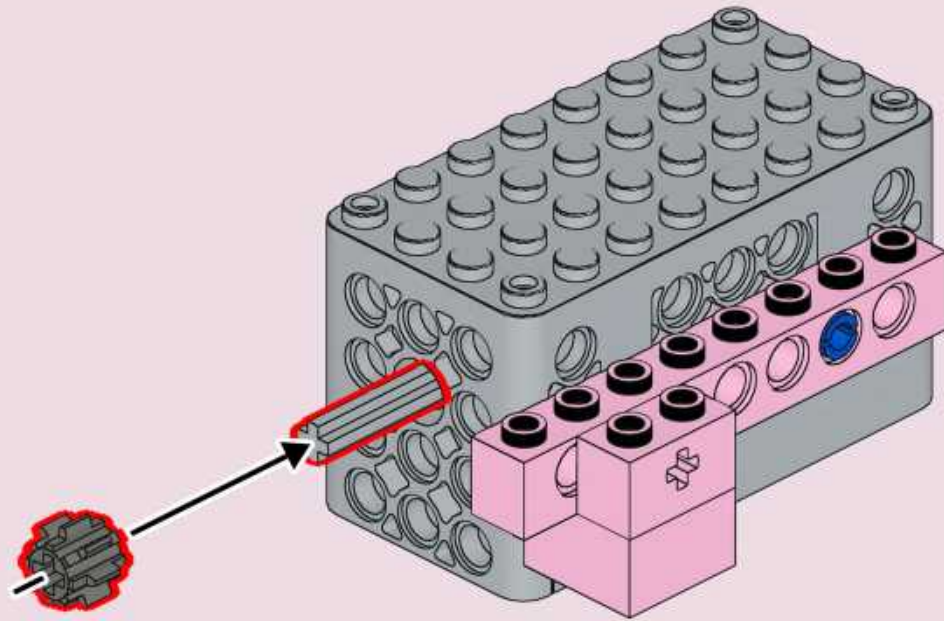
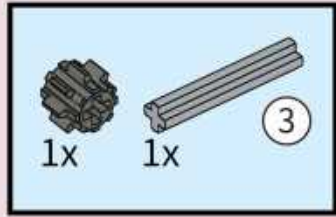

3

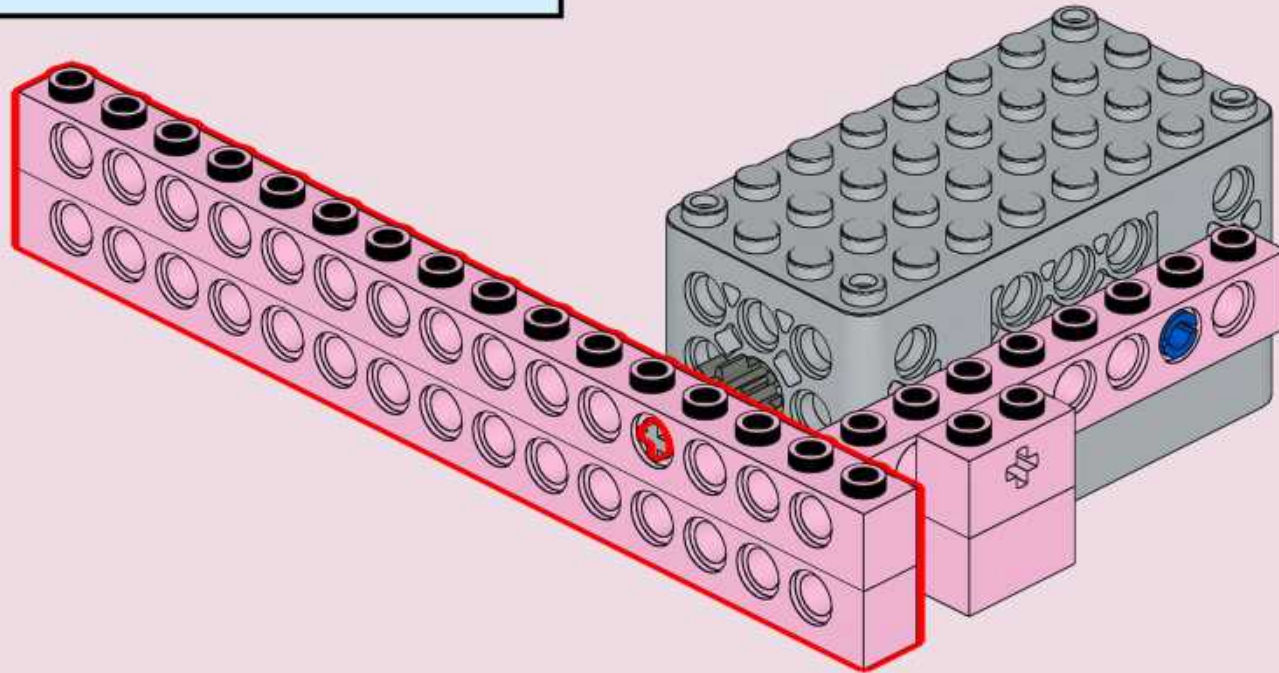
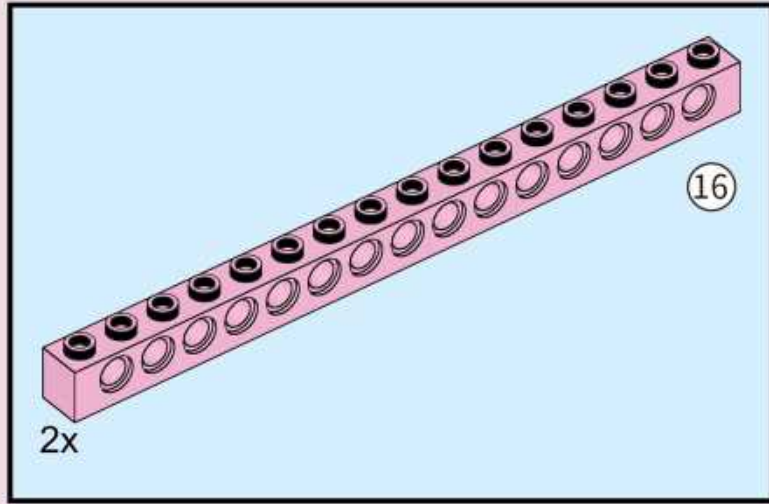

# 4

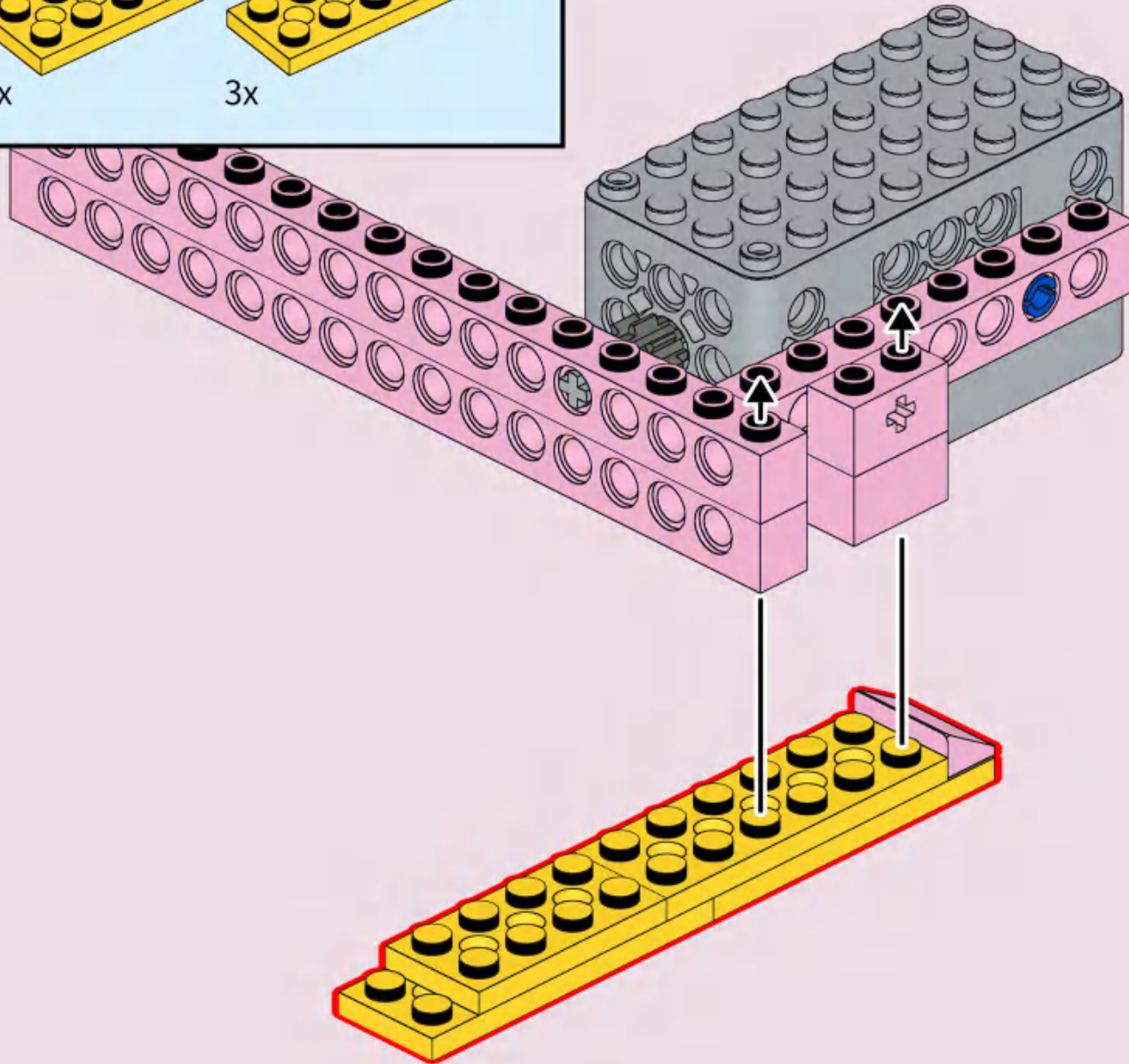
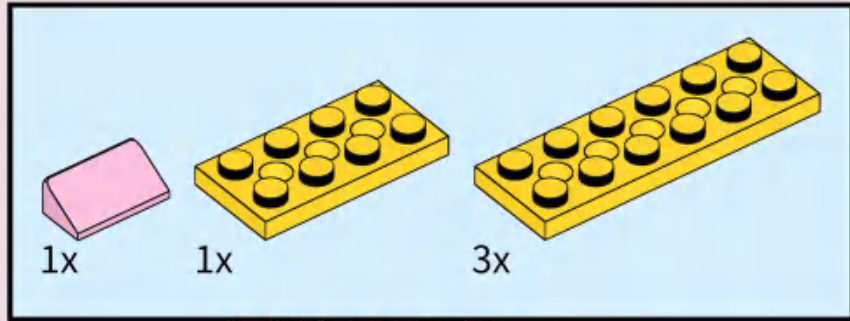

# 5

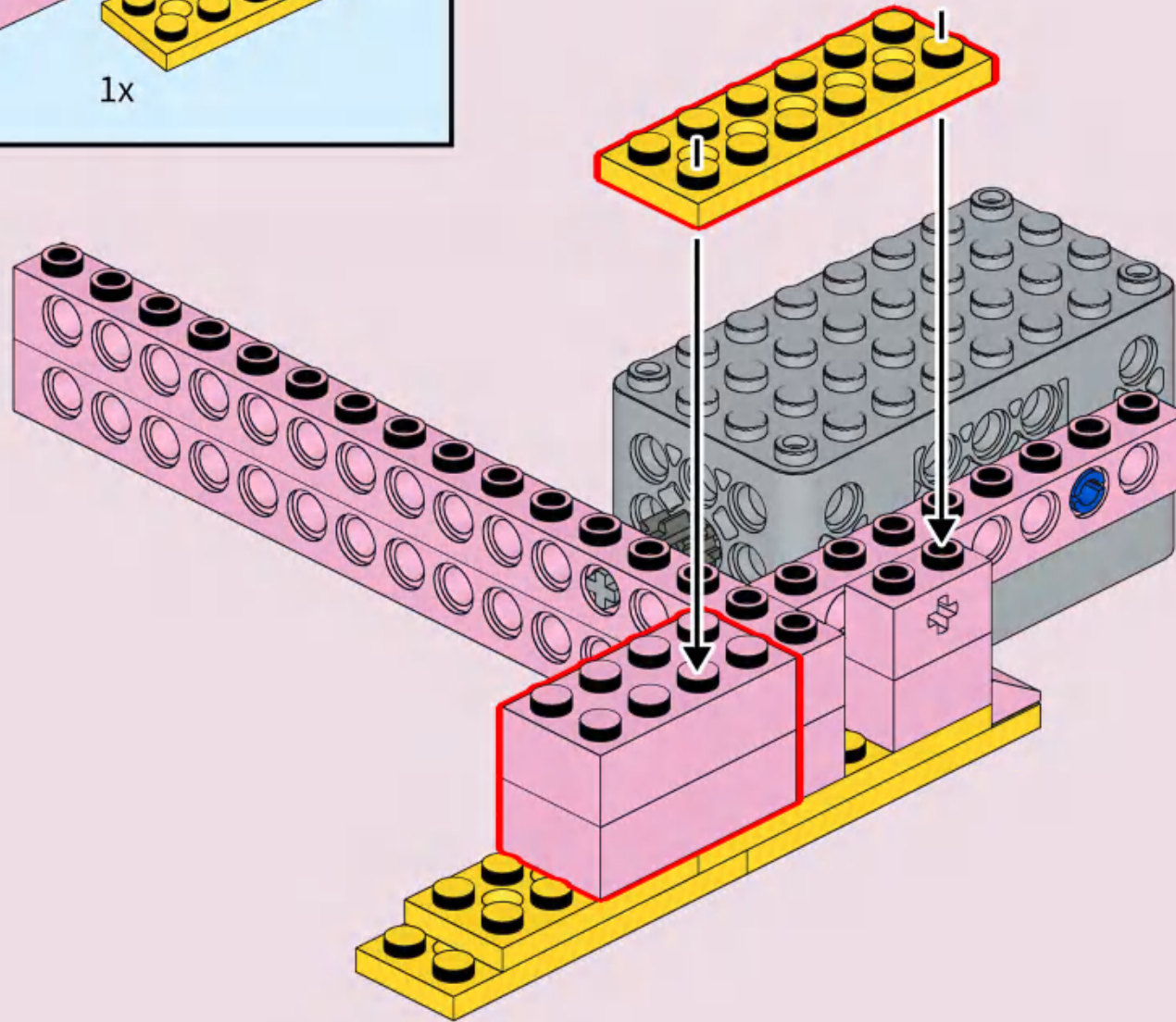
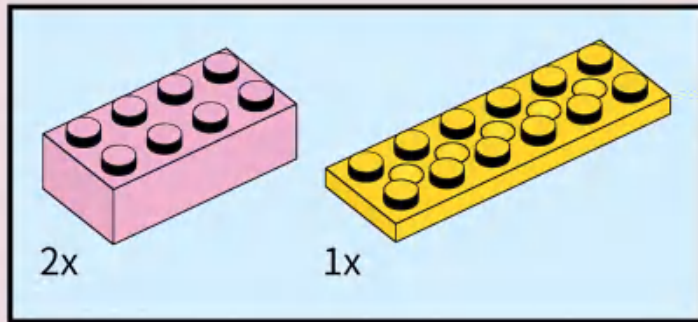



6

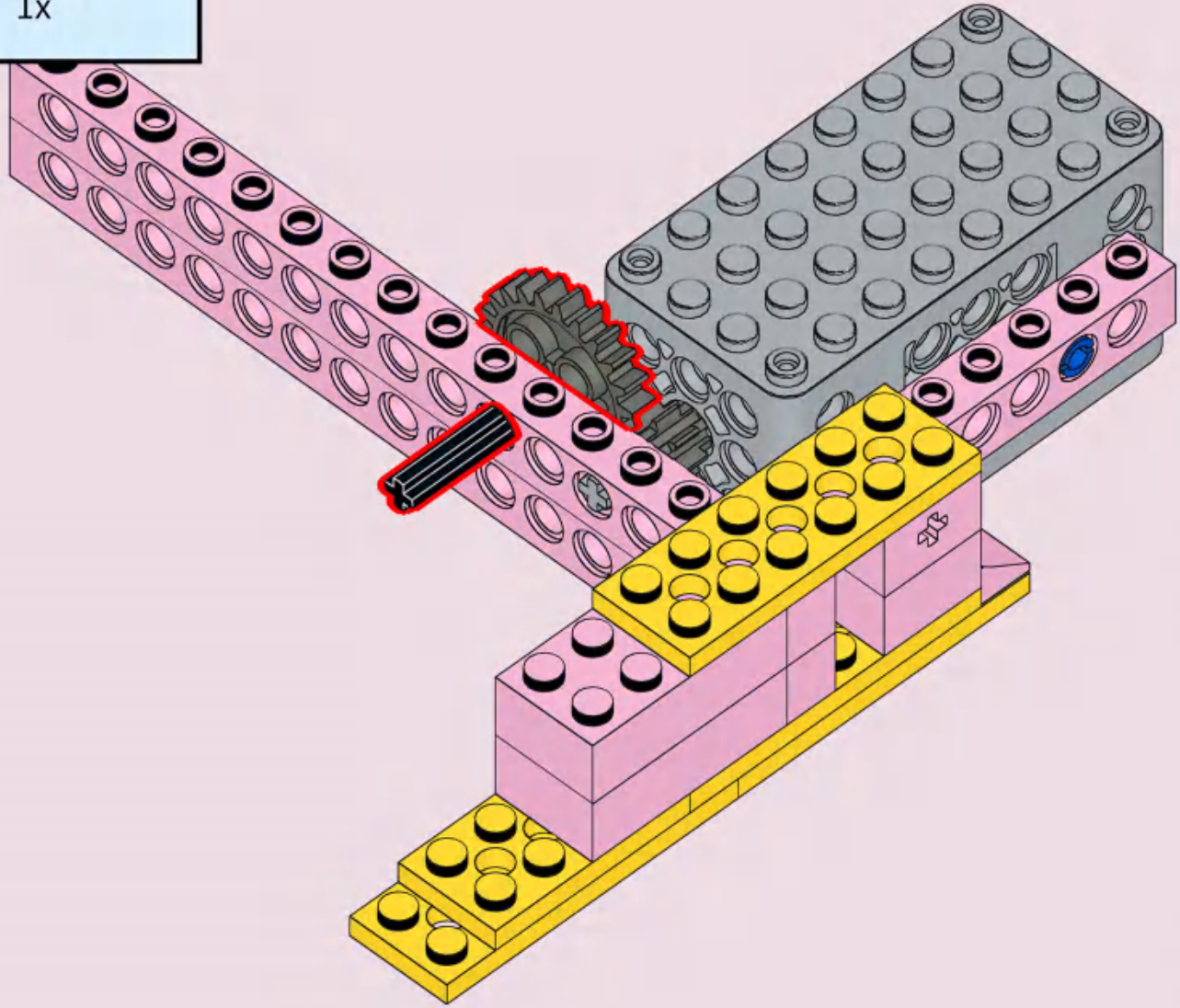
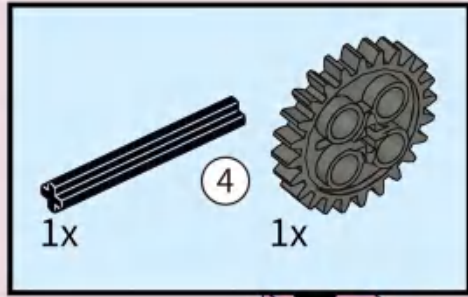



7

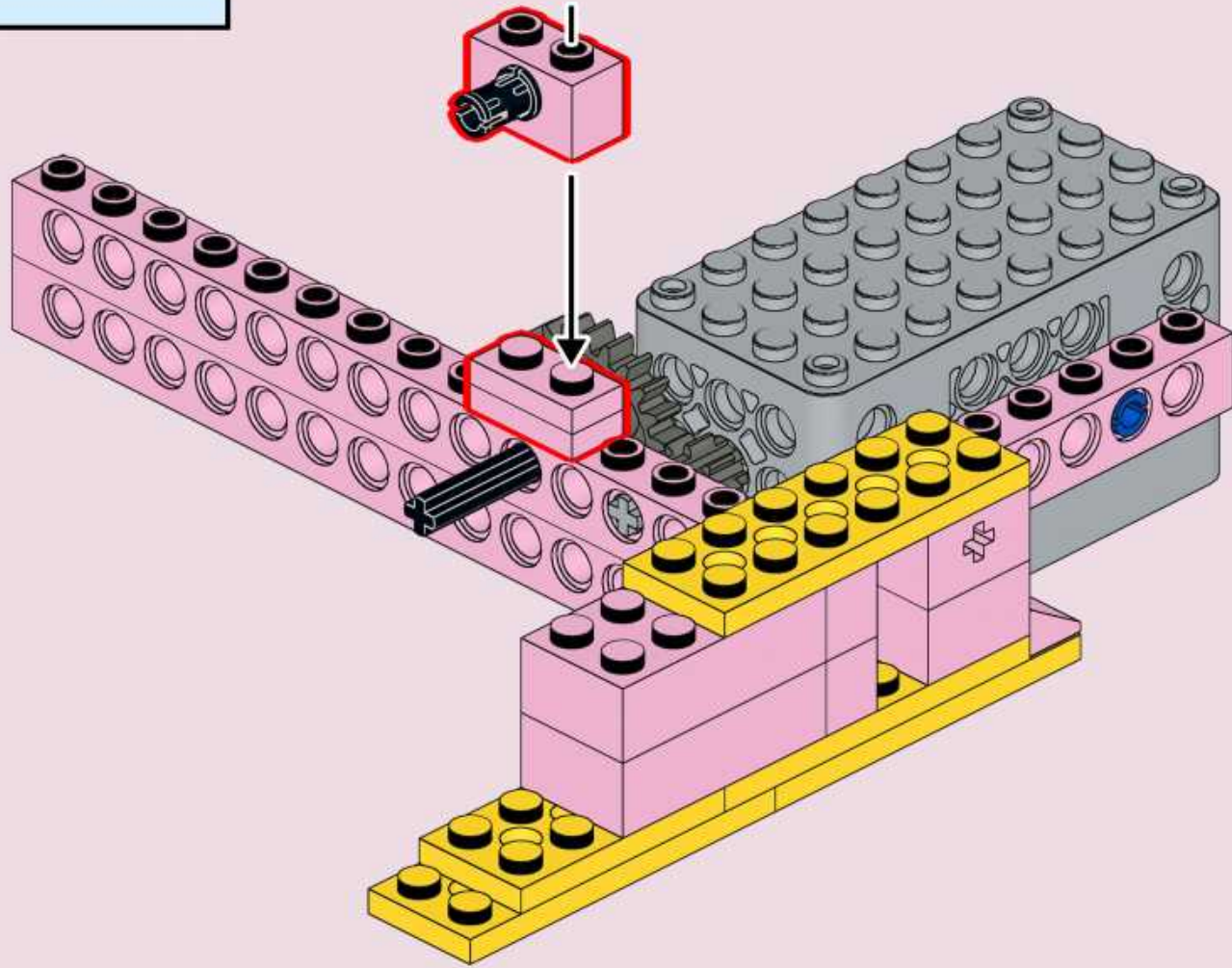
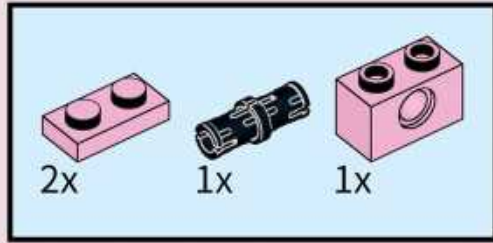

8

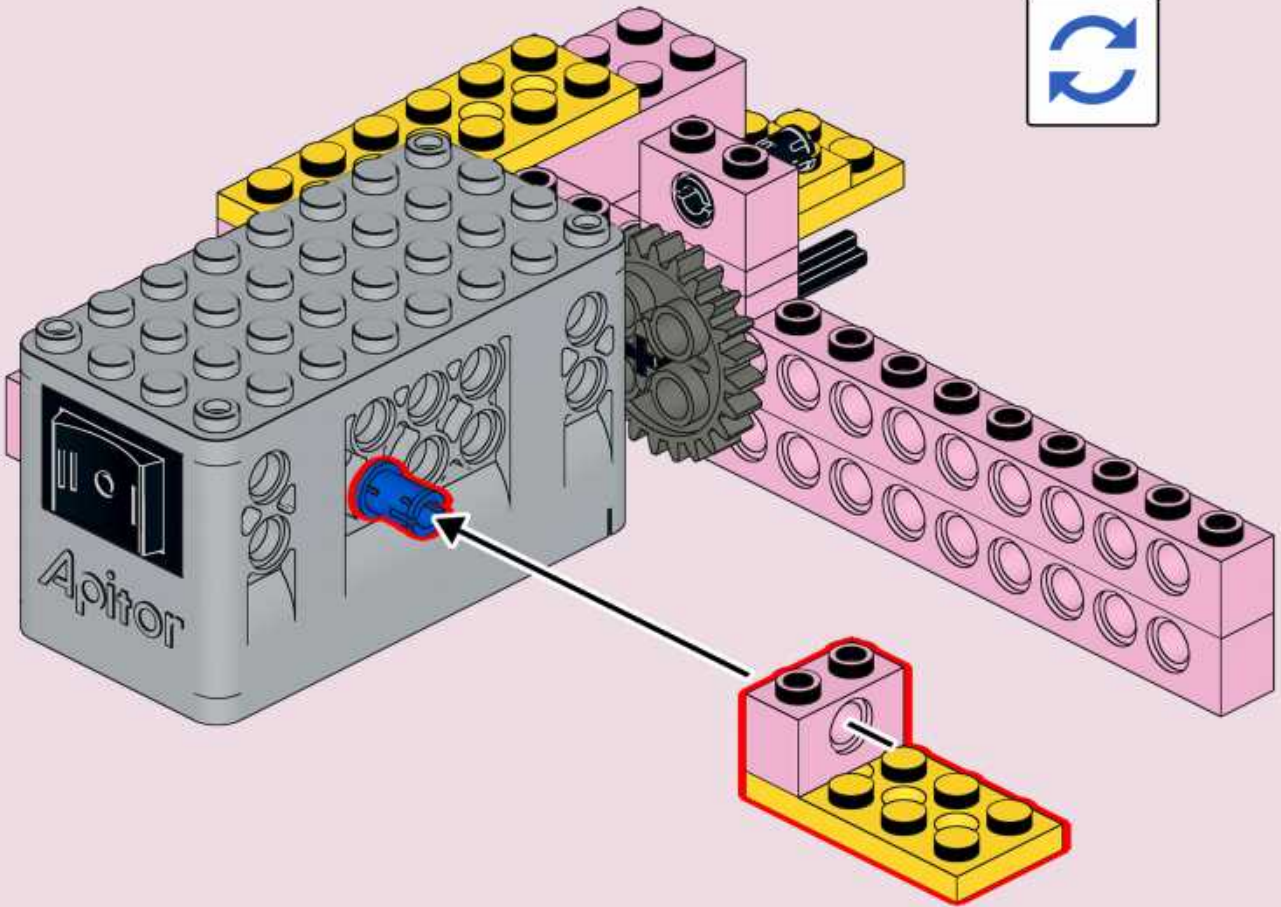
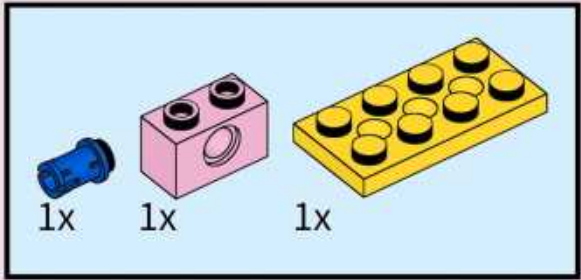

# 9

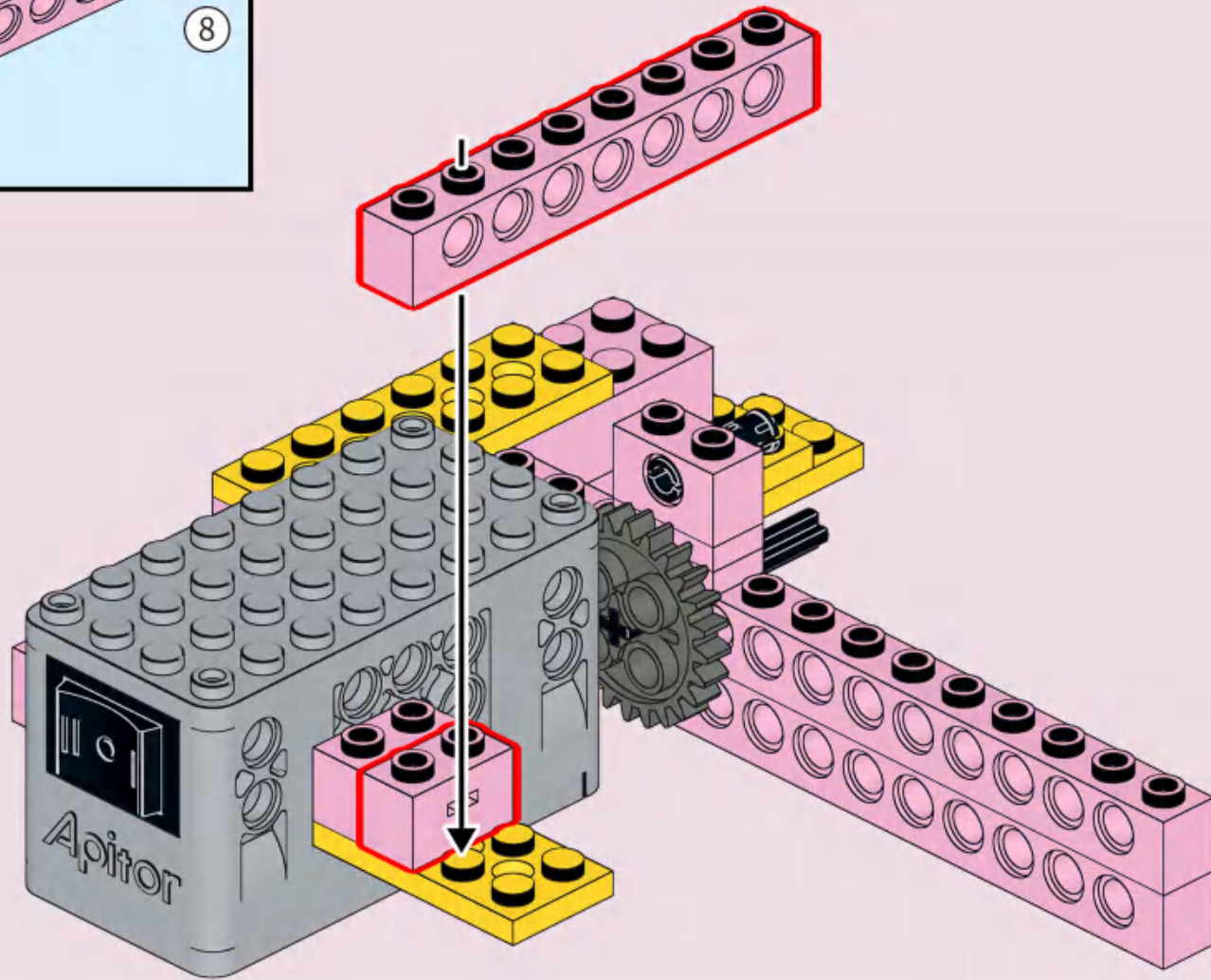
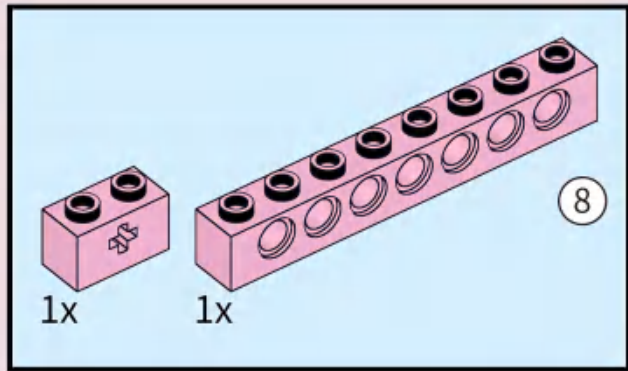



# 10

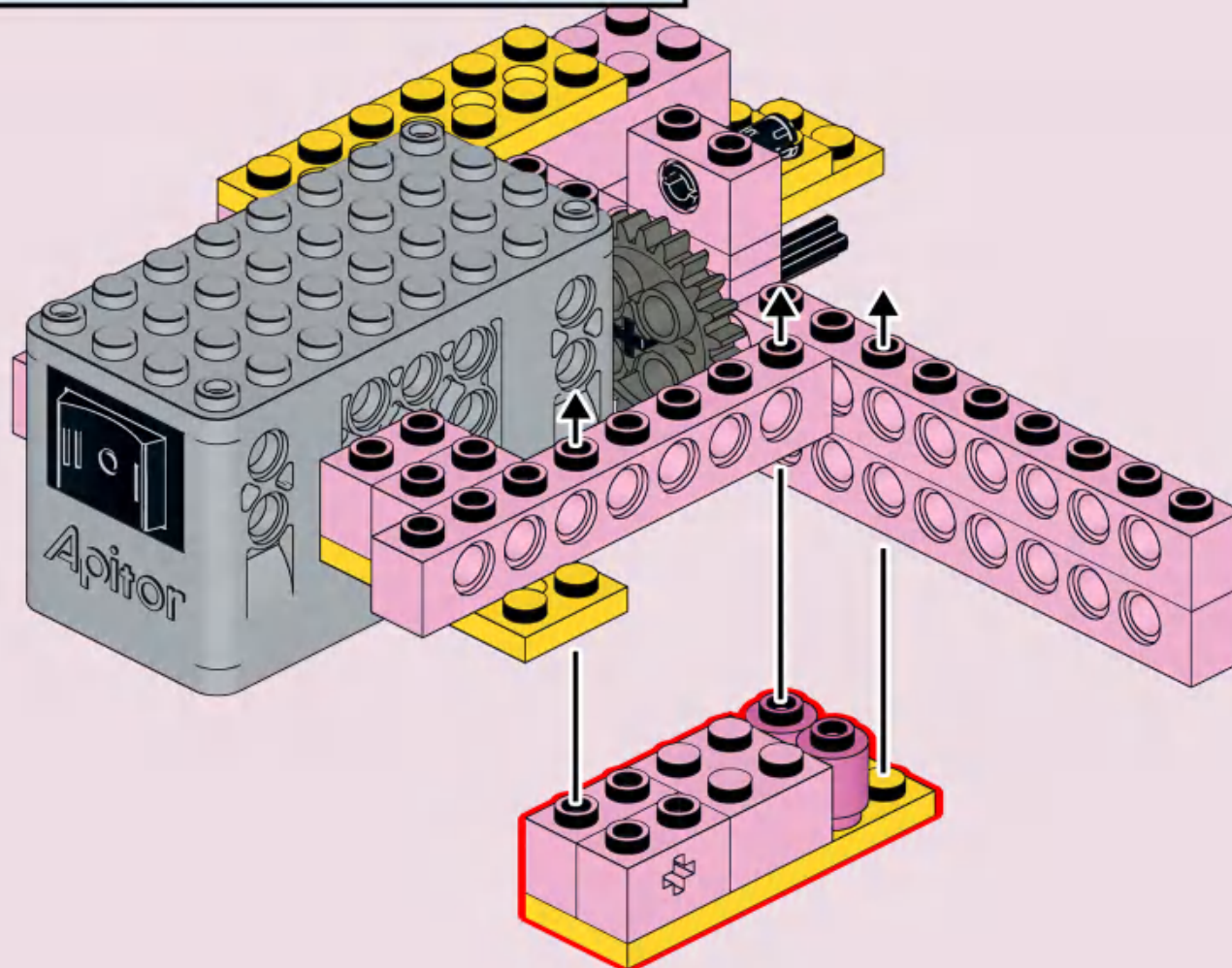
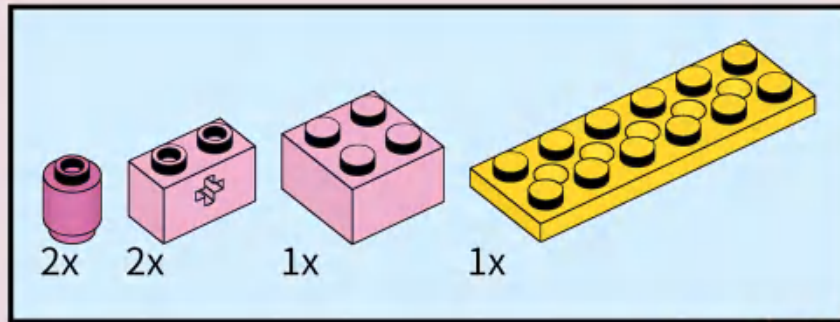

# 11

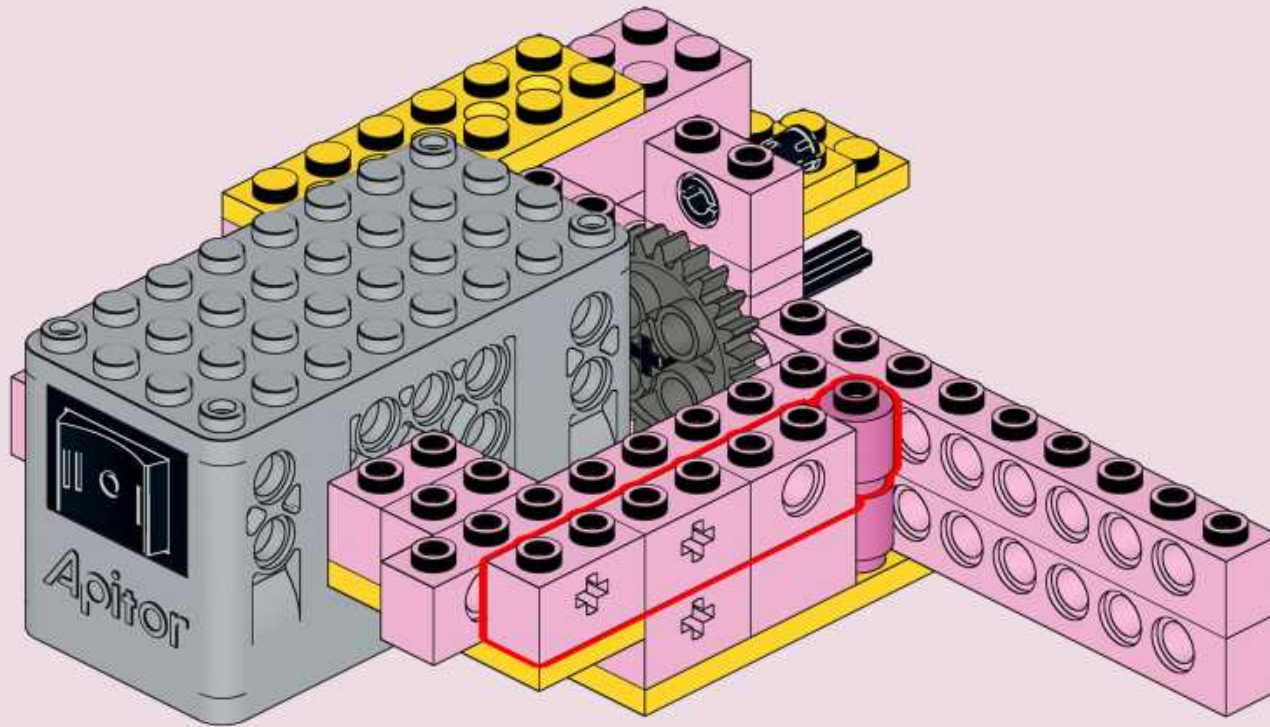
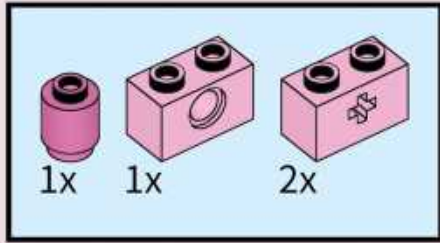

# 12

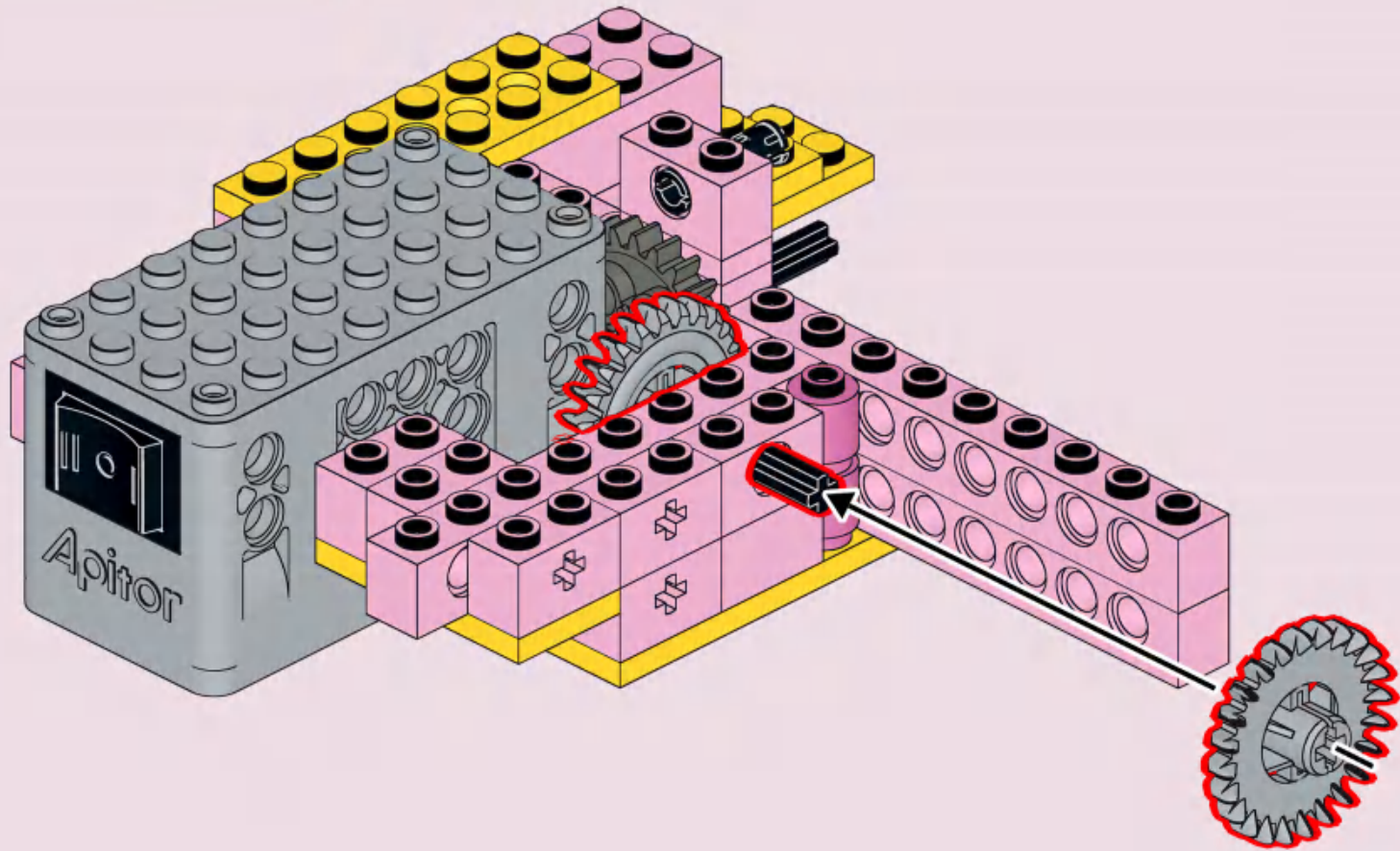
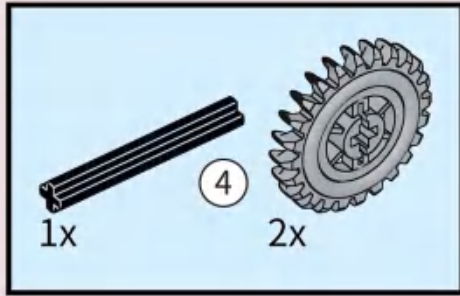



# 13

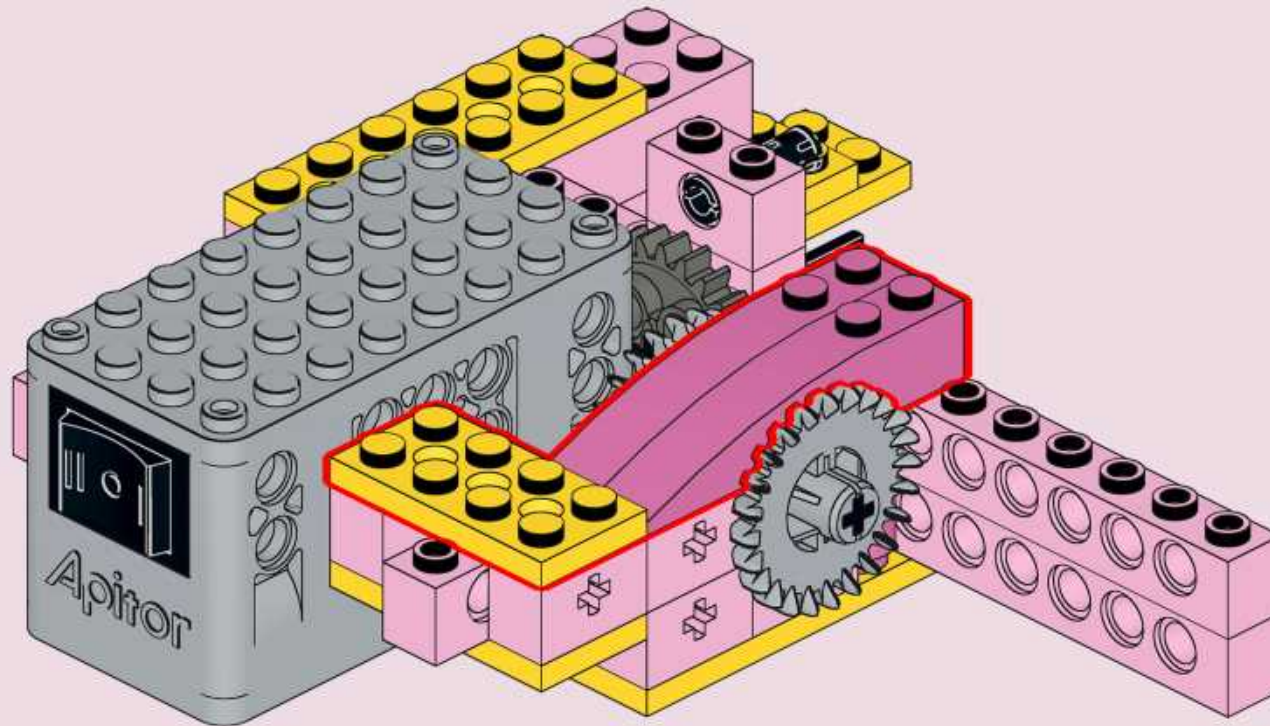
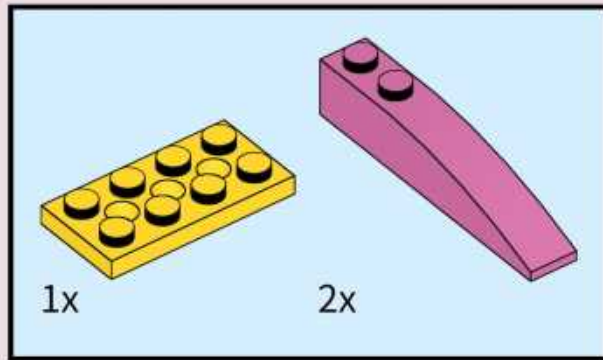

# 14

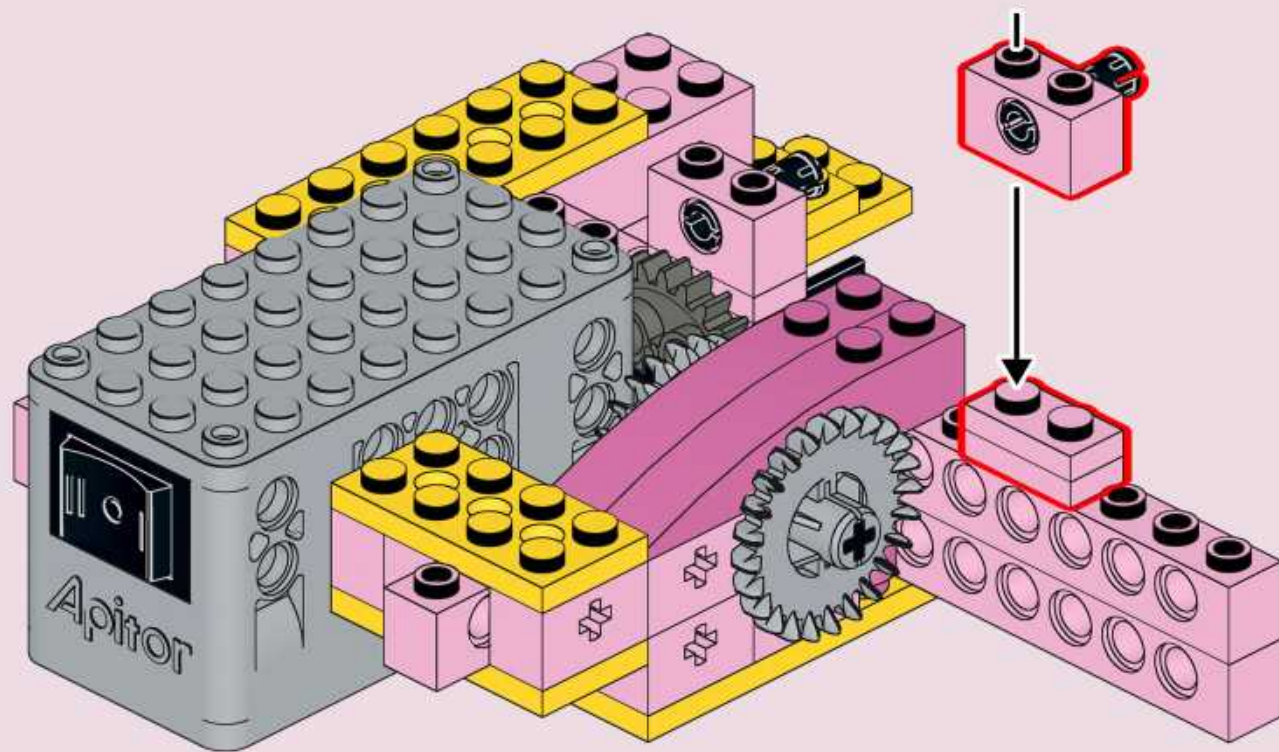
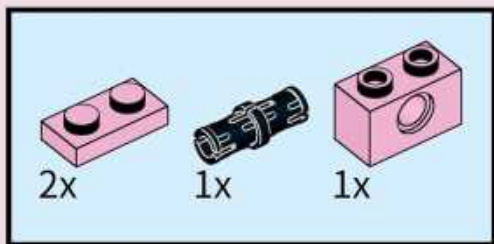

# 15

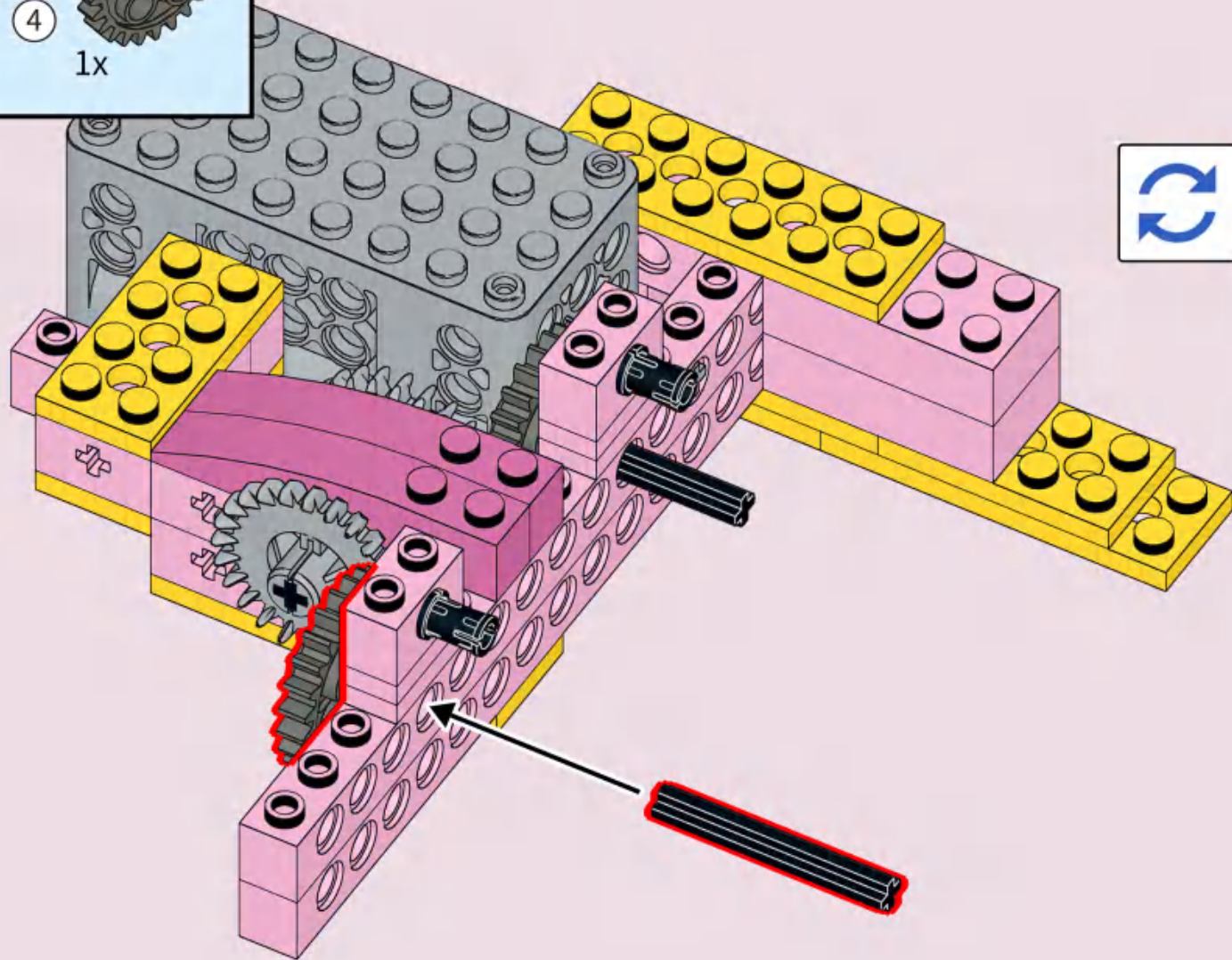
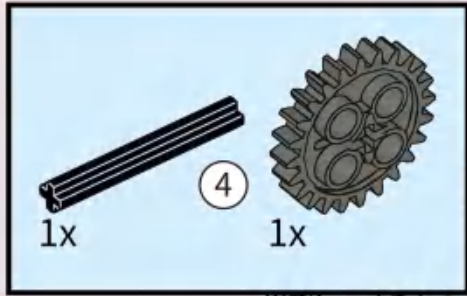



# 16

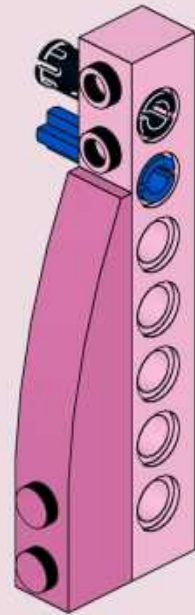
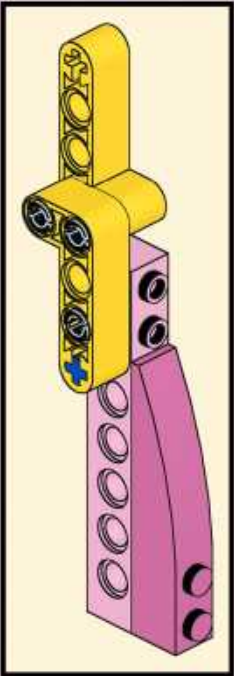
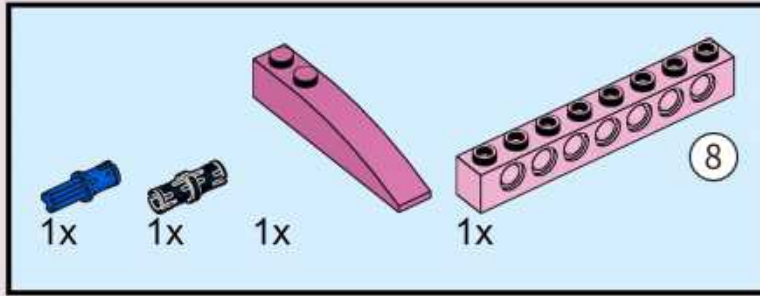

# 17

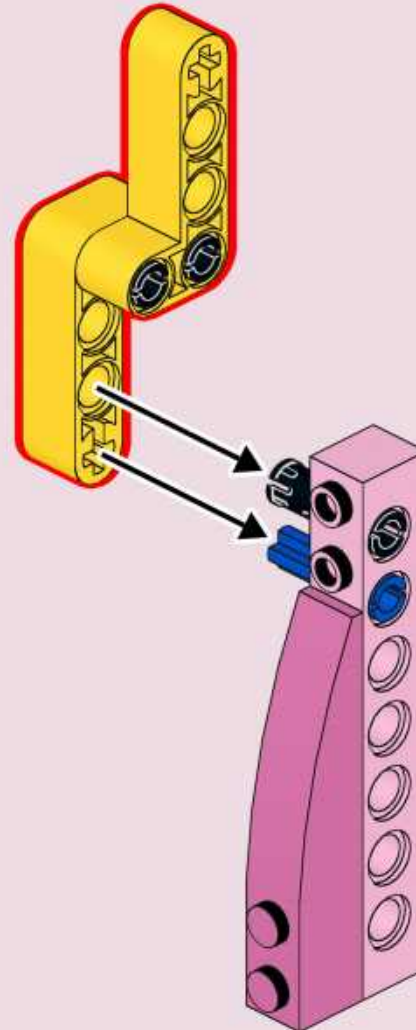
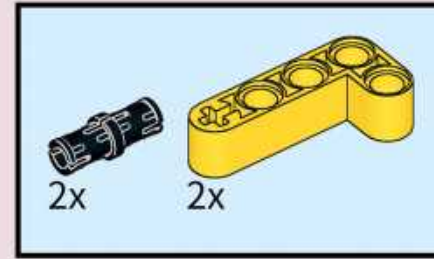

# 18

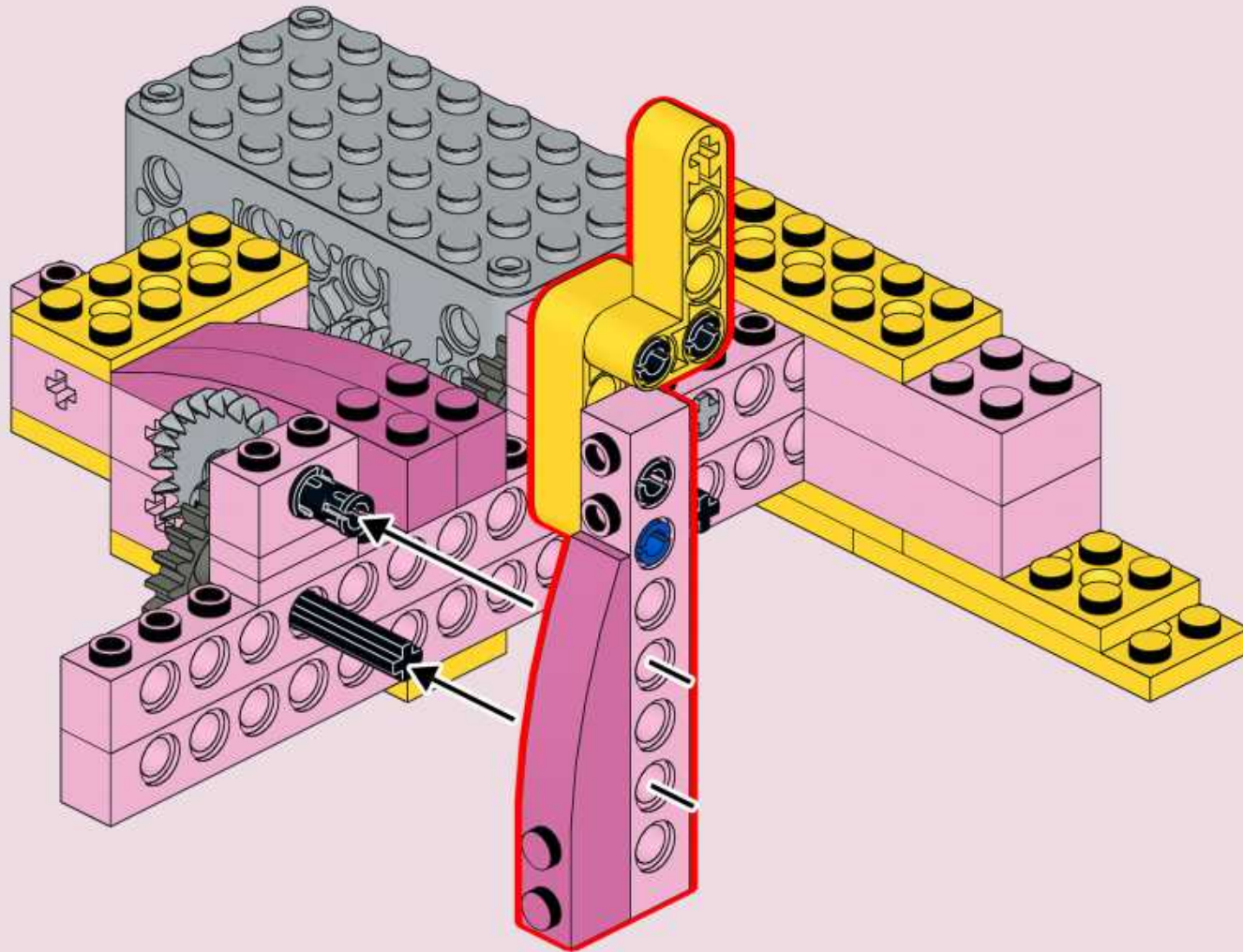

# 19

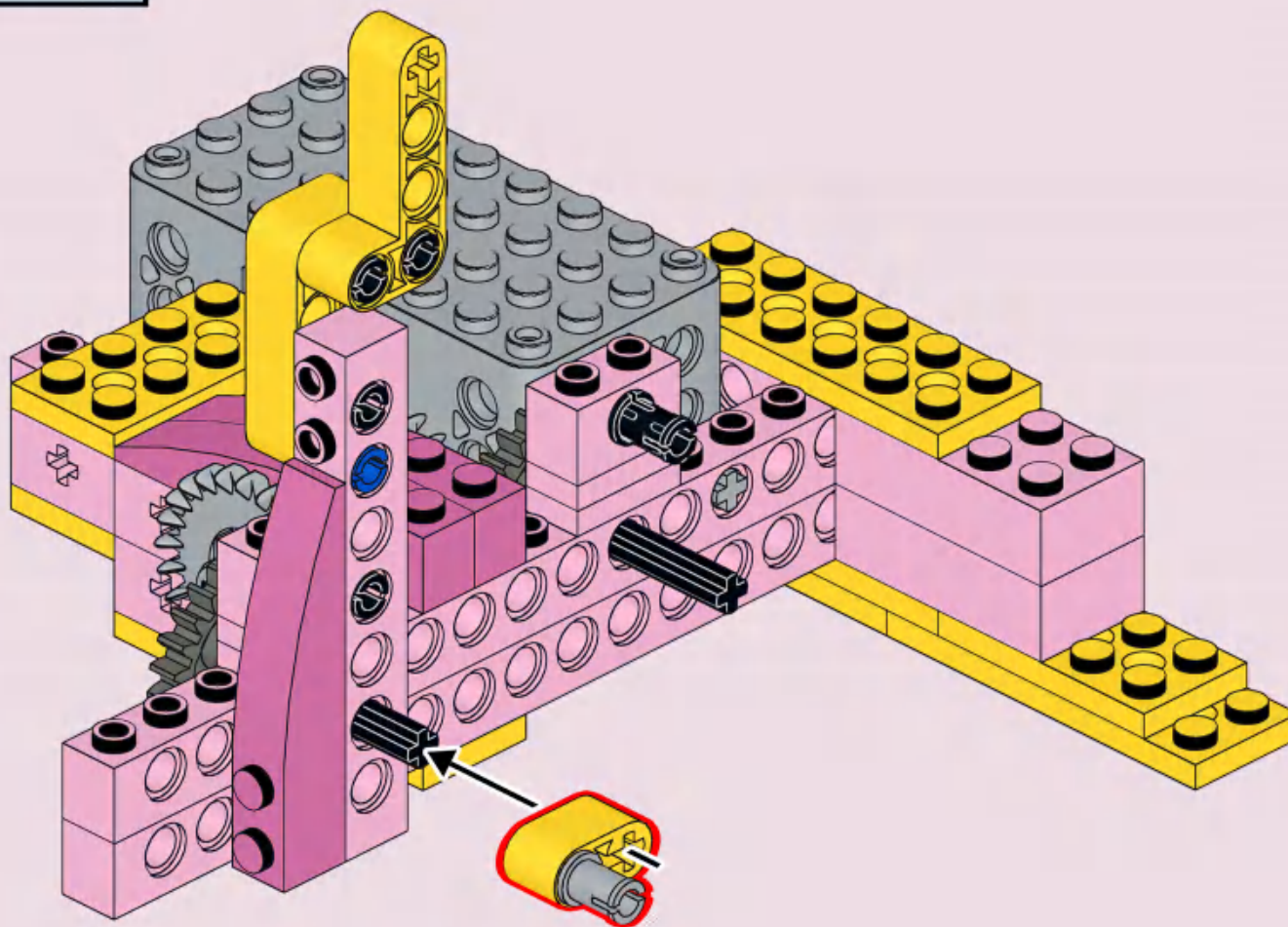
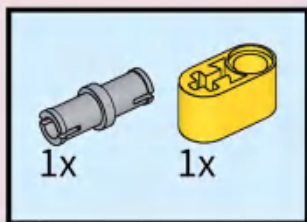



# 20

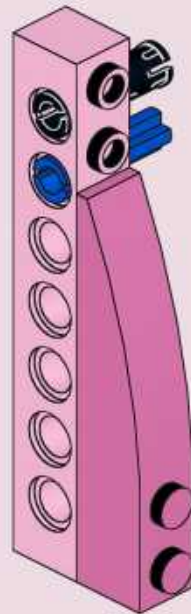
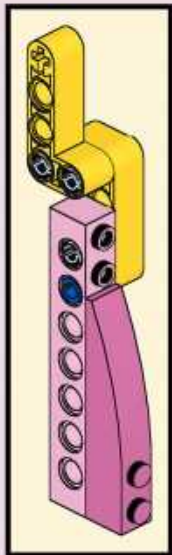
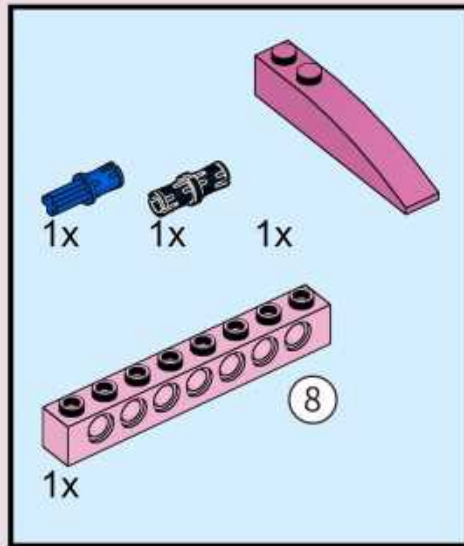

# 21

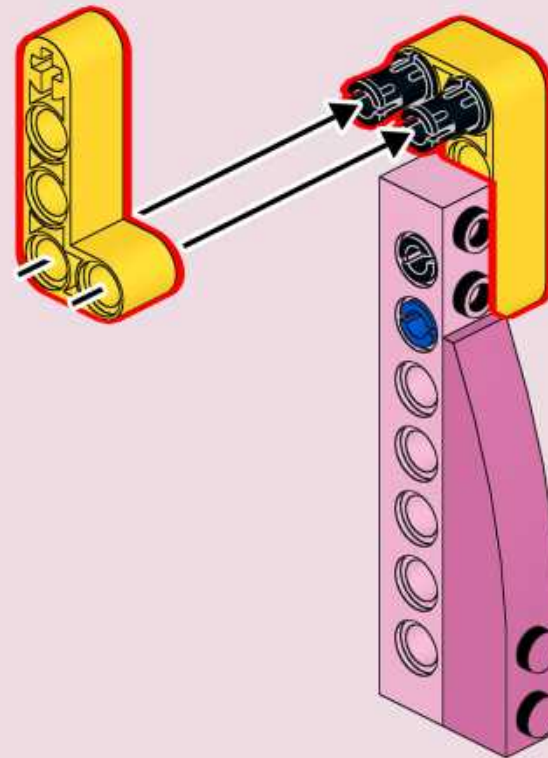
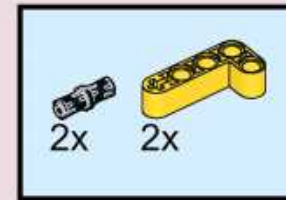

# 22

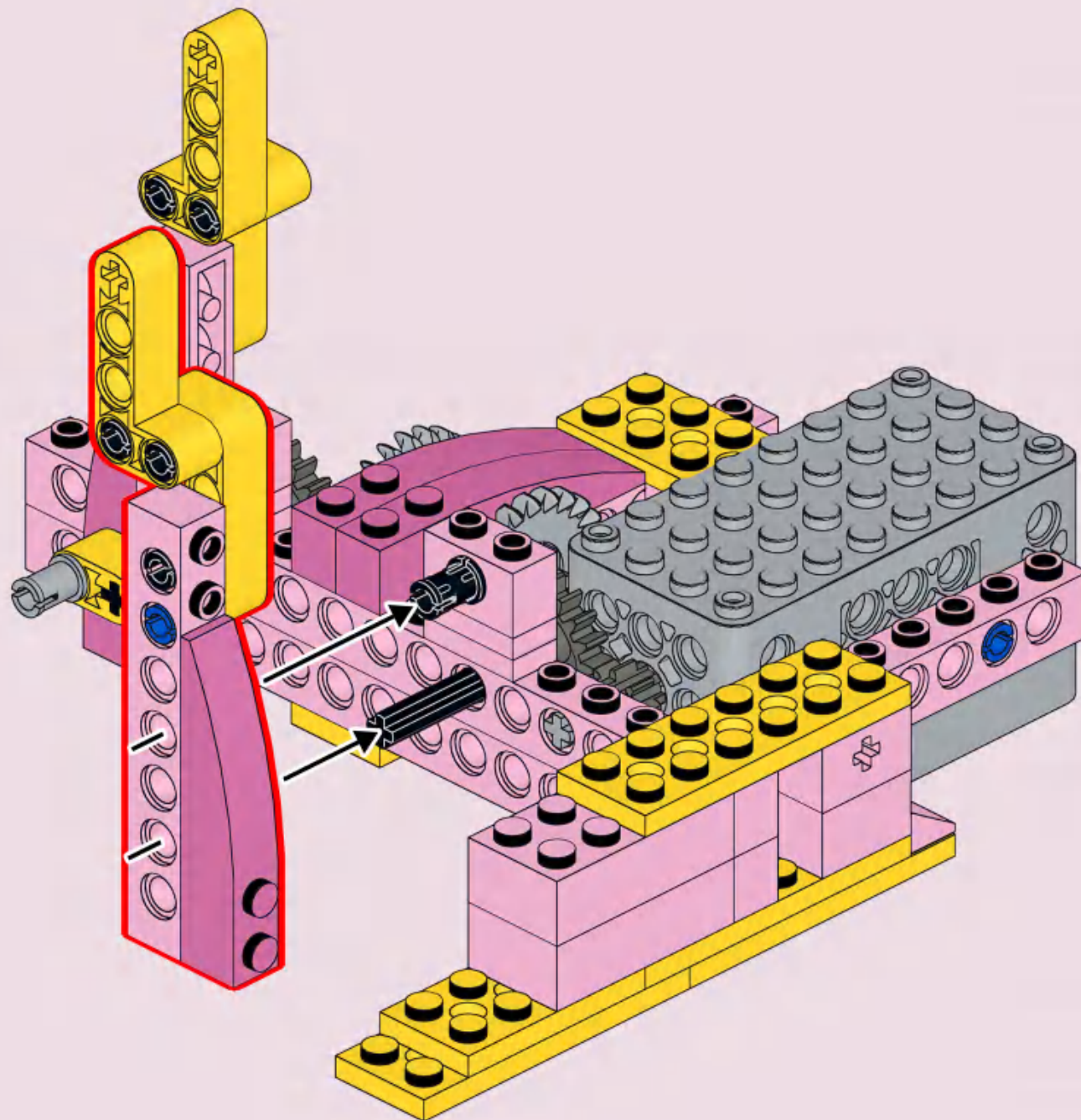

# 23

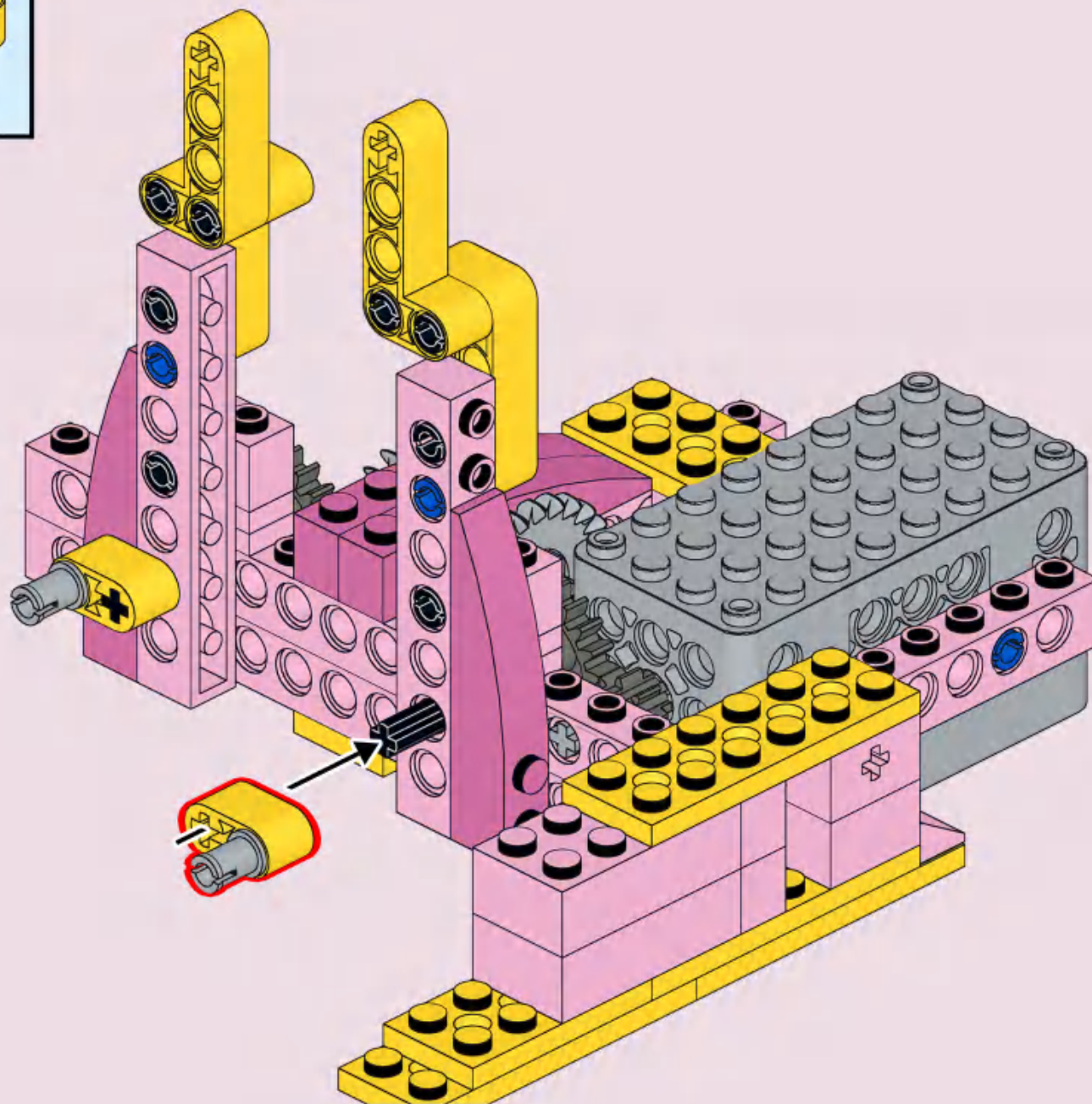
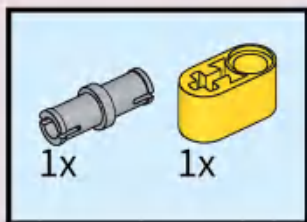



# 24

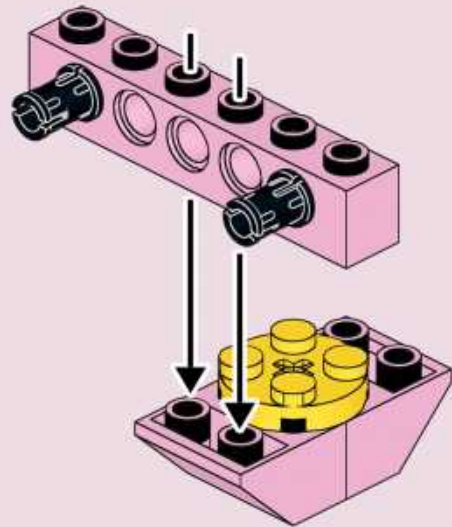
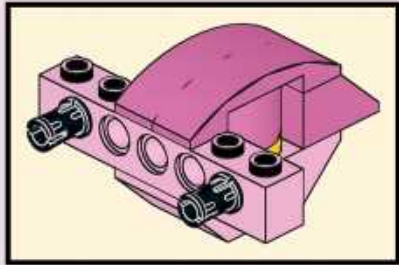
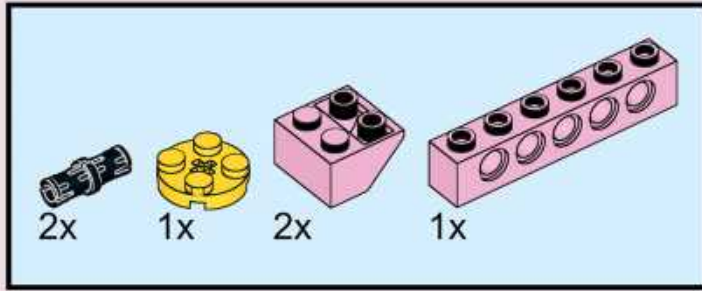

# 25

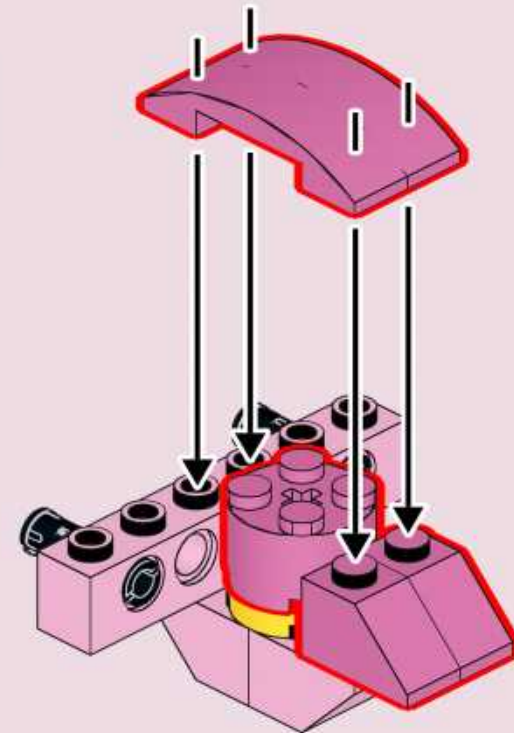
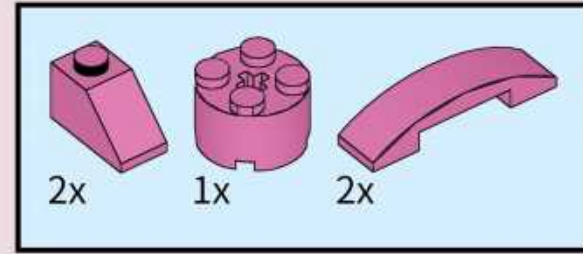

# 26

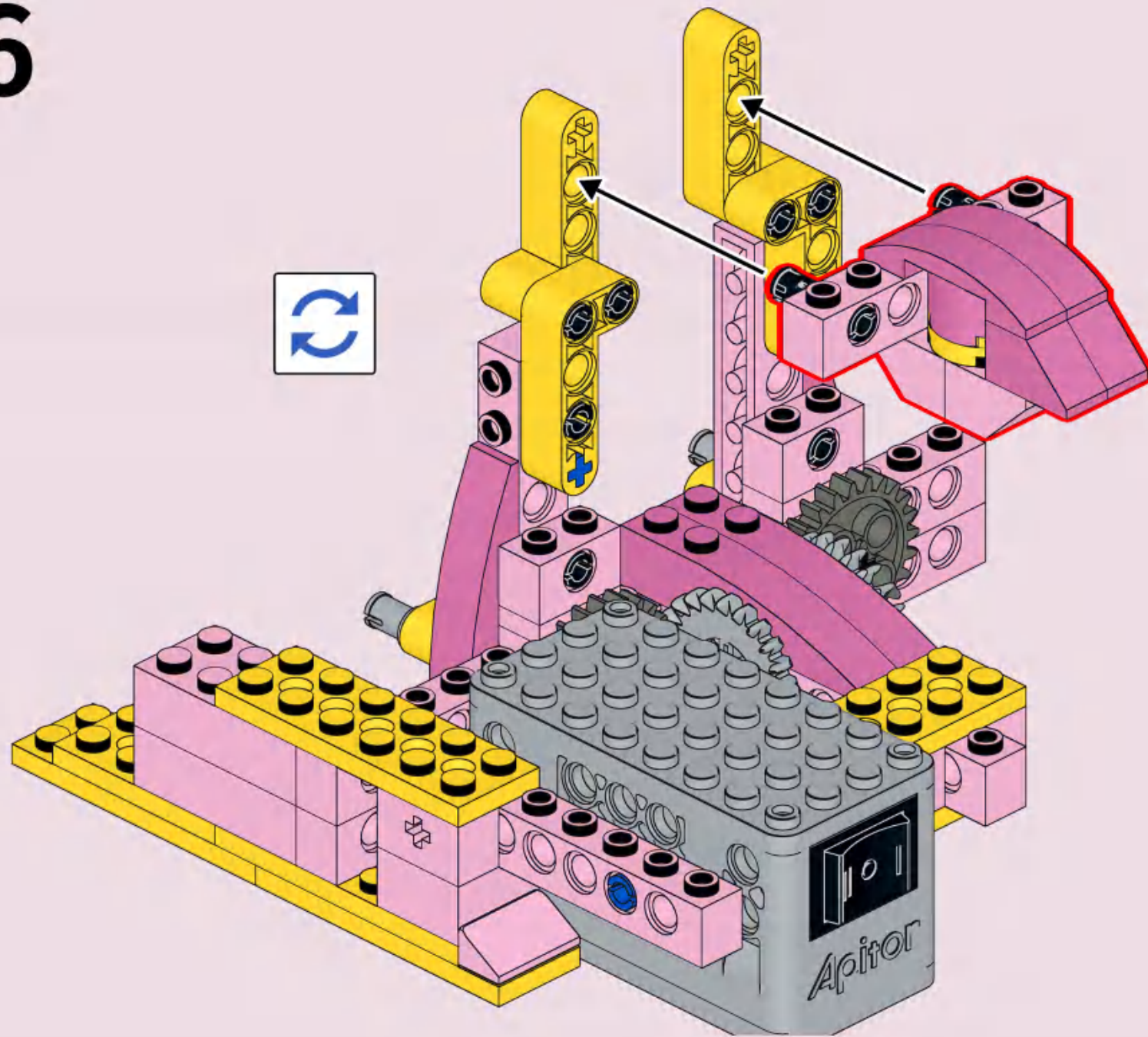

# 27

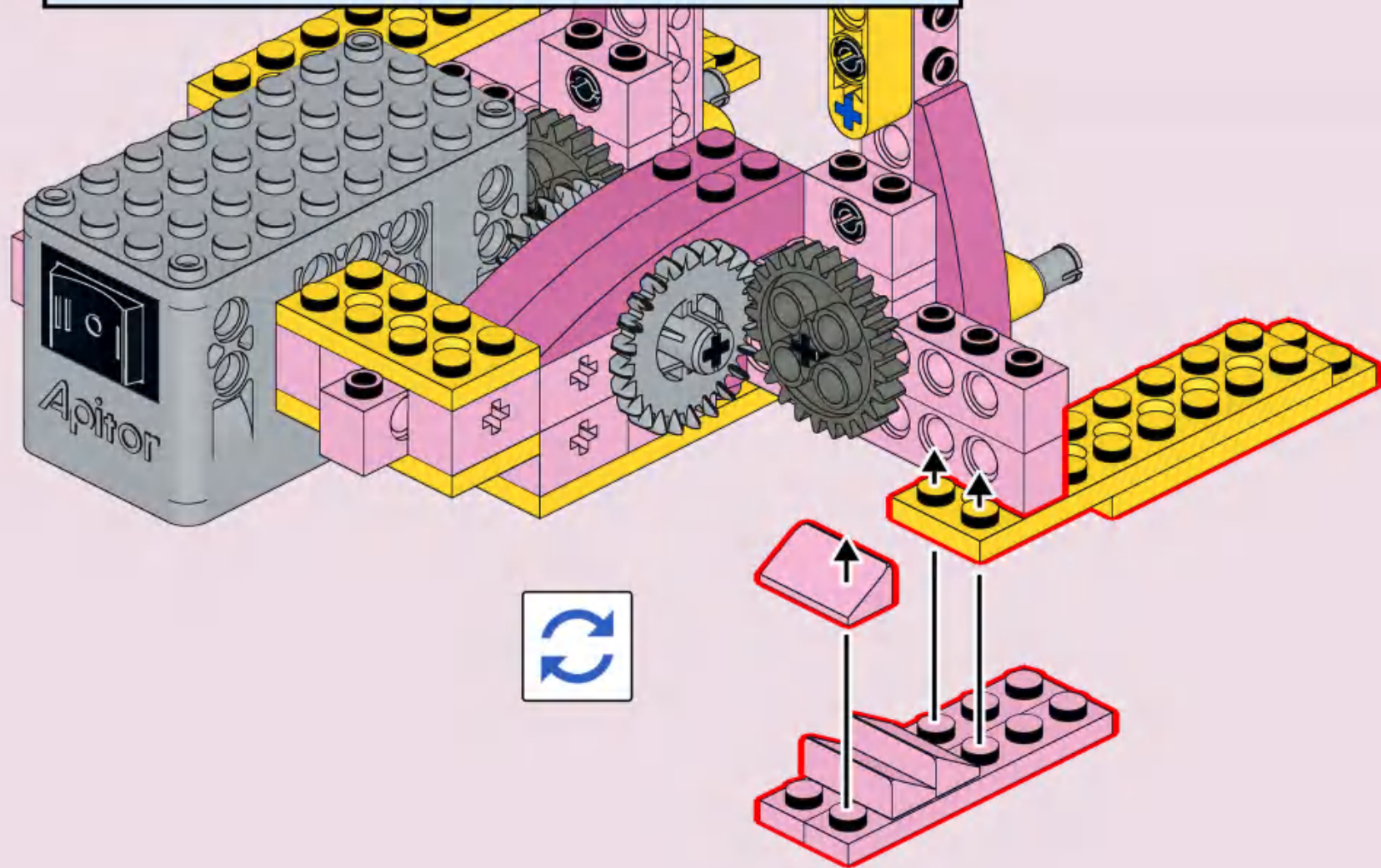
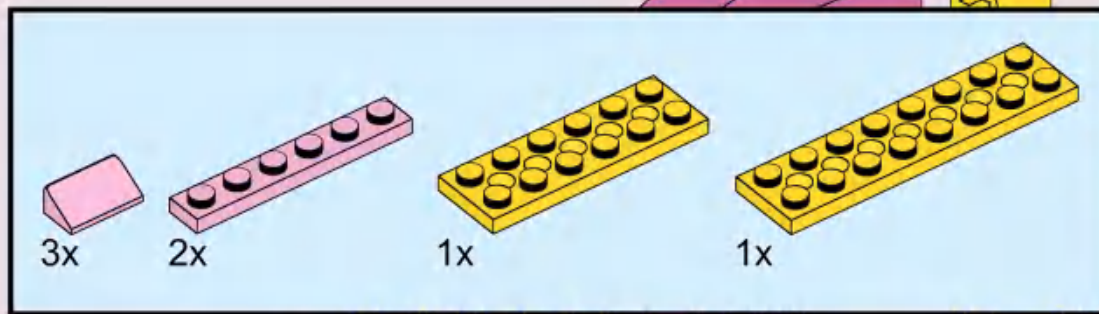



# 28

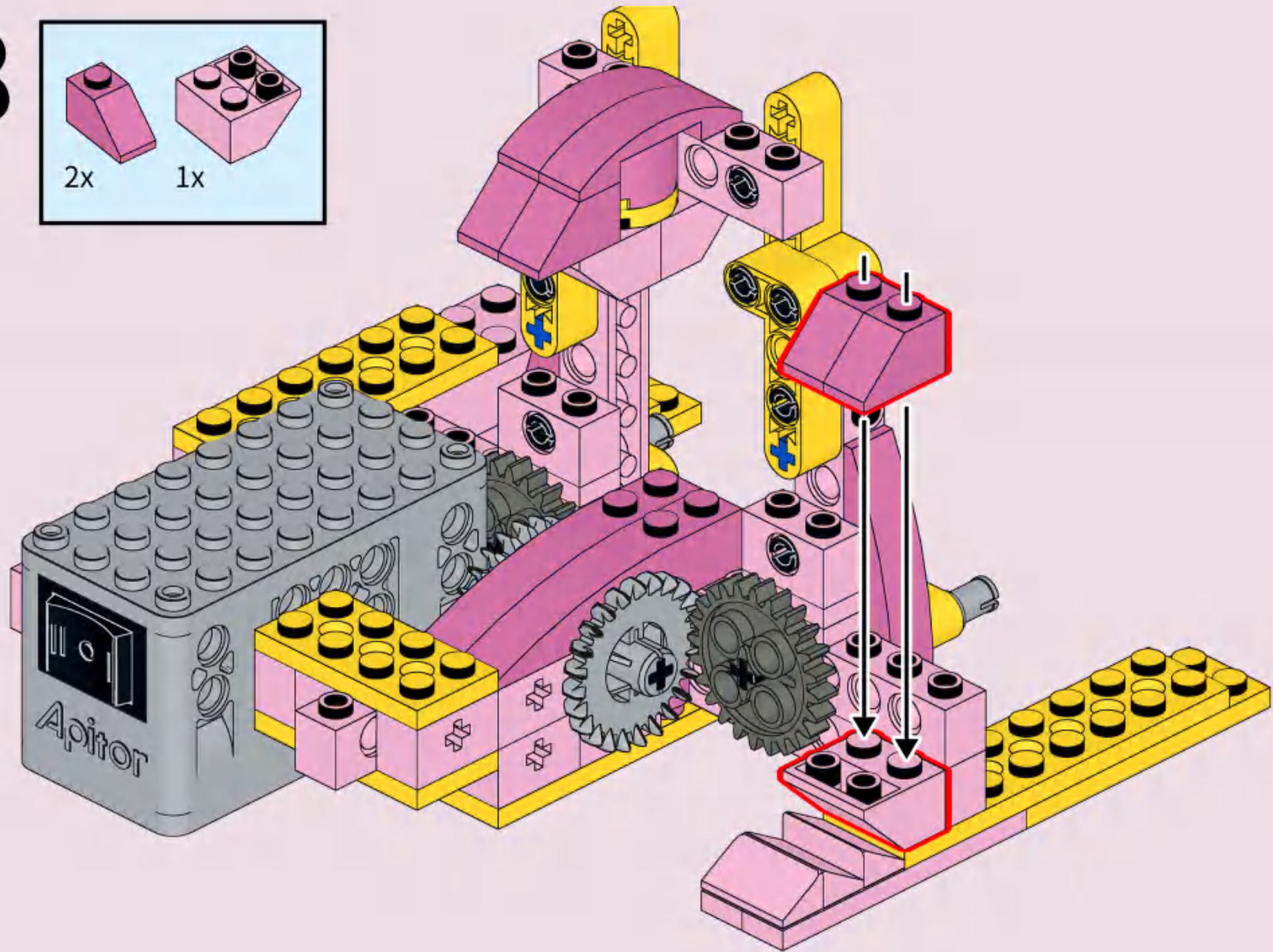
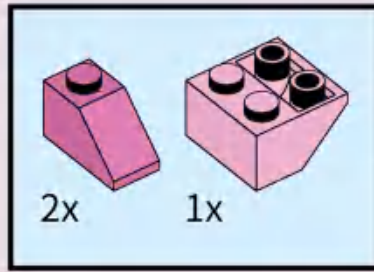

# 29

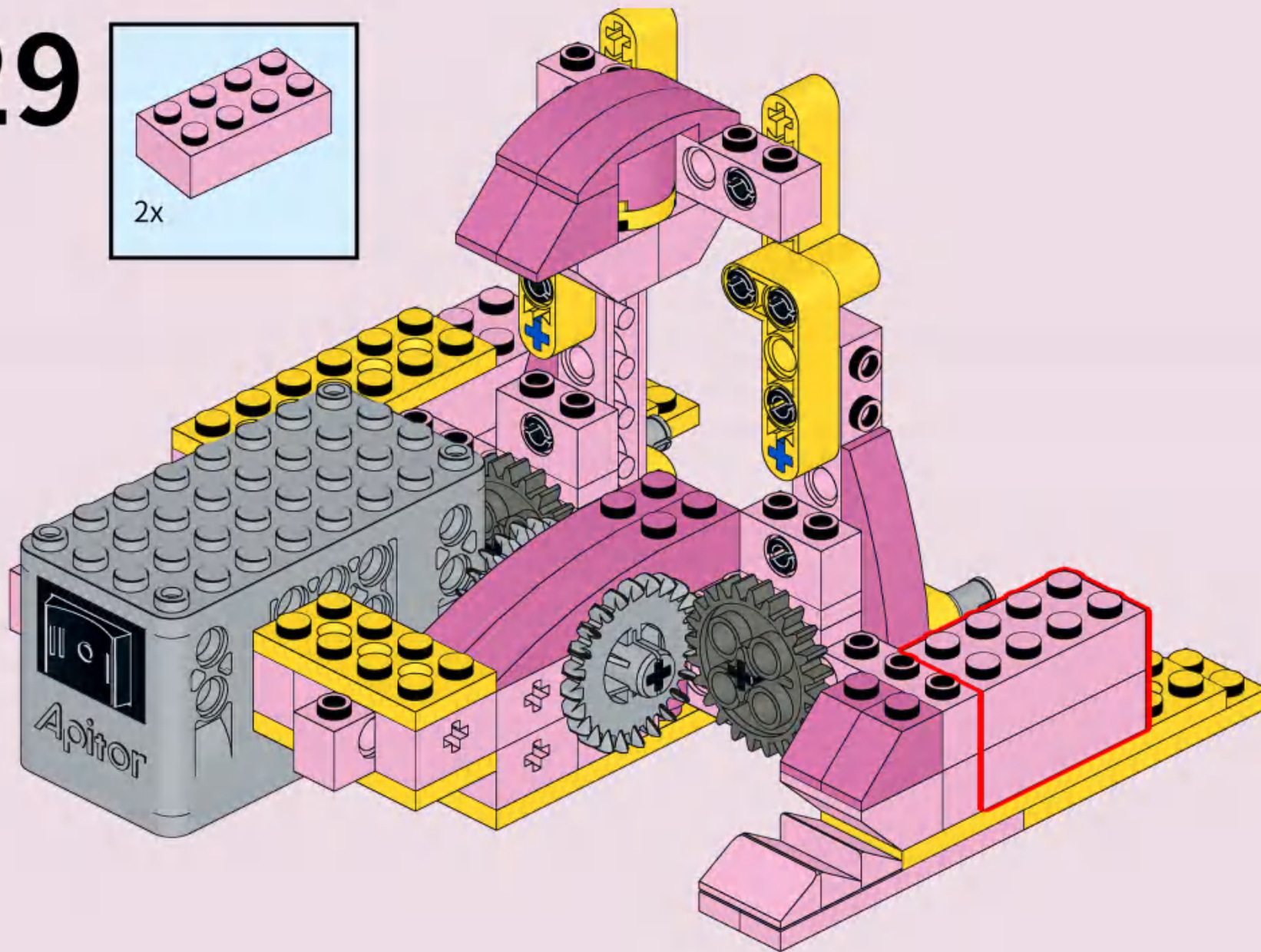
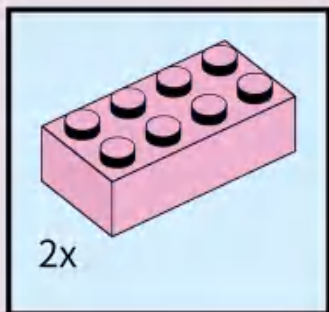



# 30

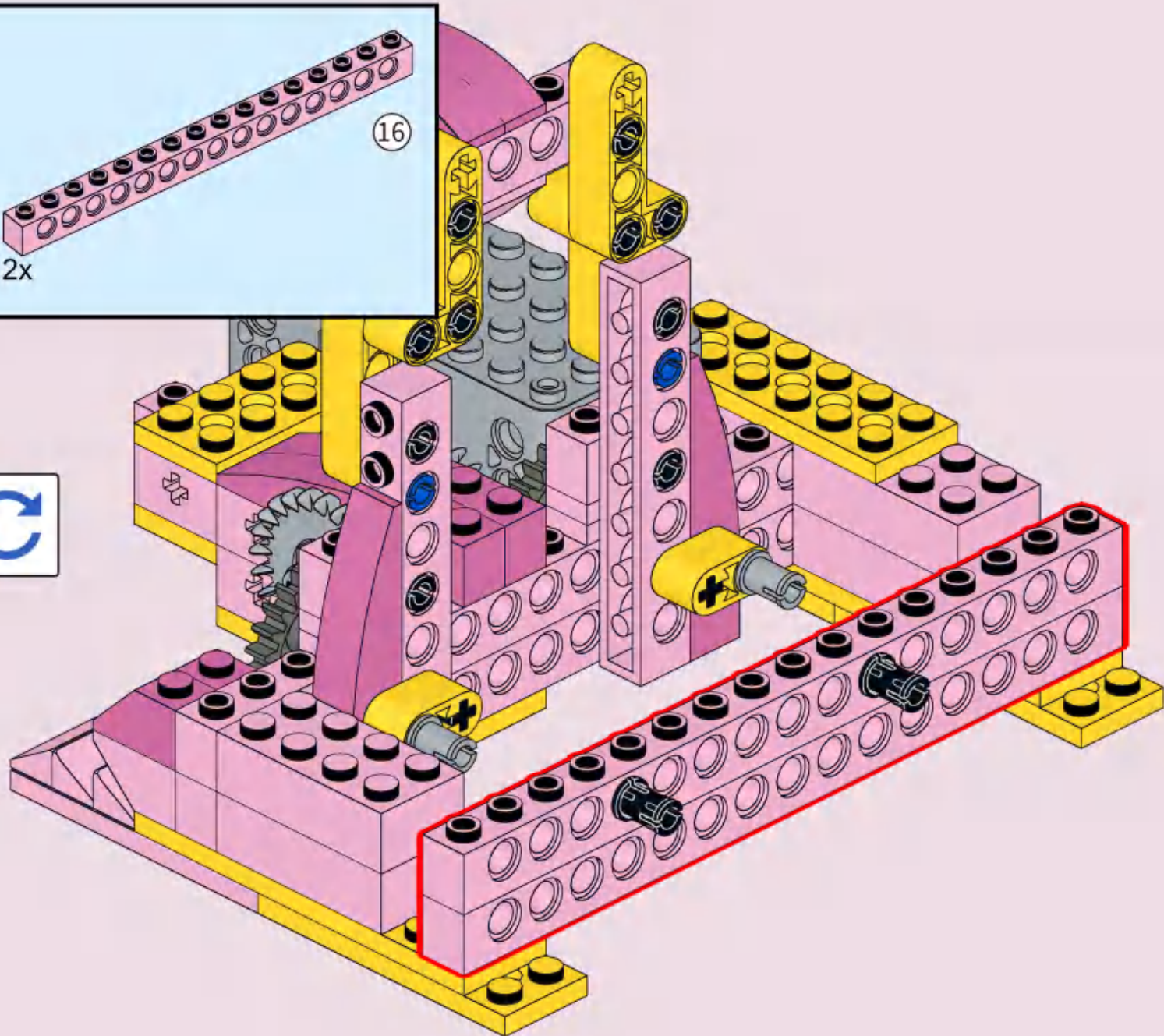
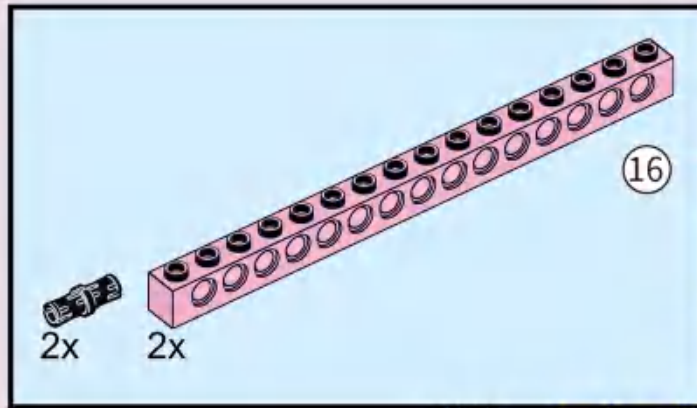



# 31

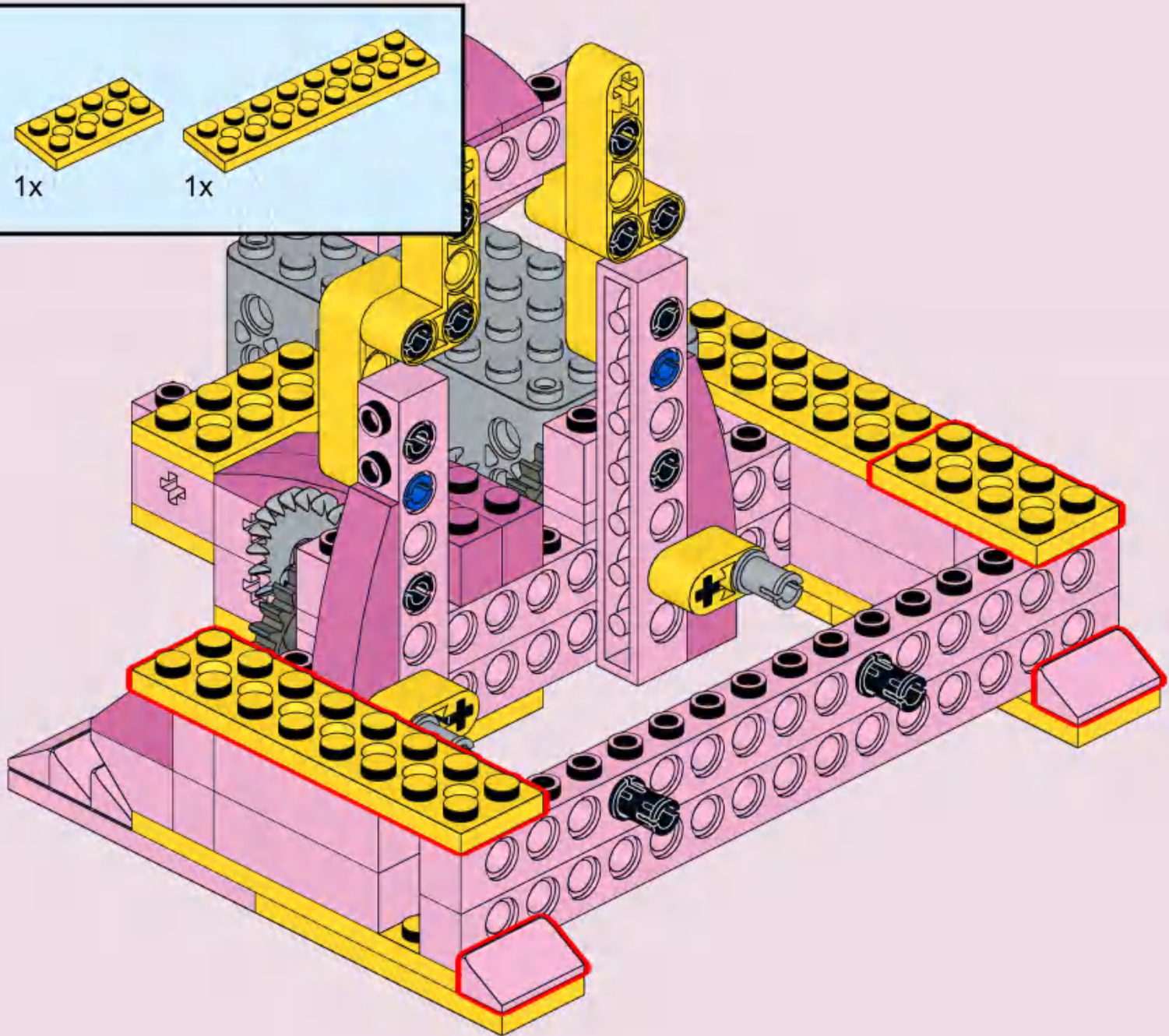
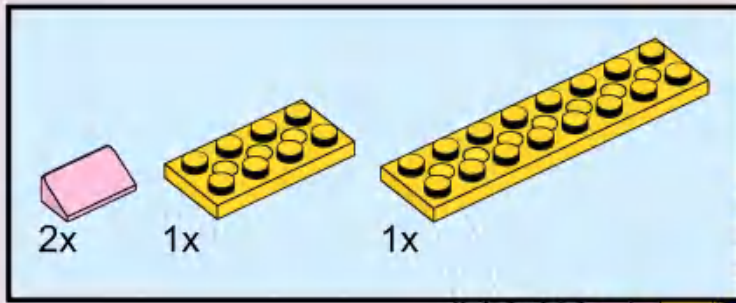

# 32

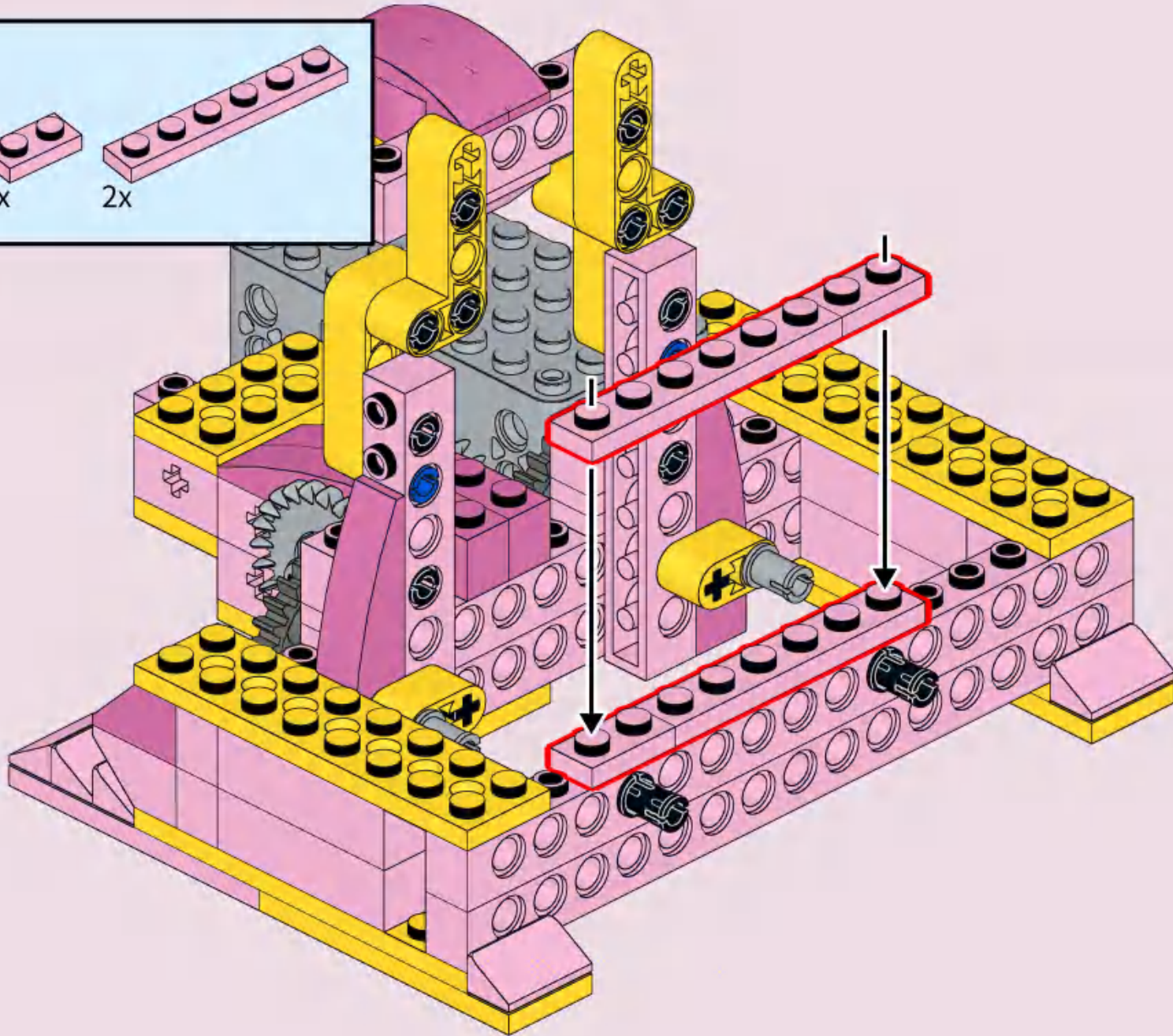
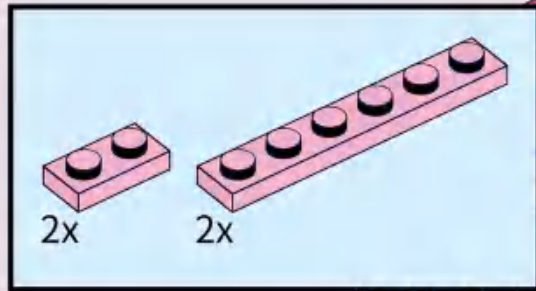



# 33

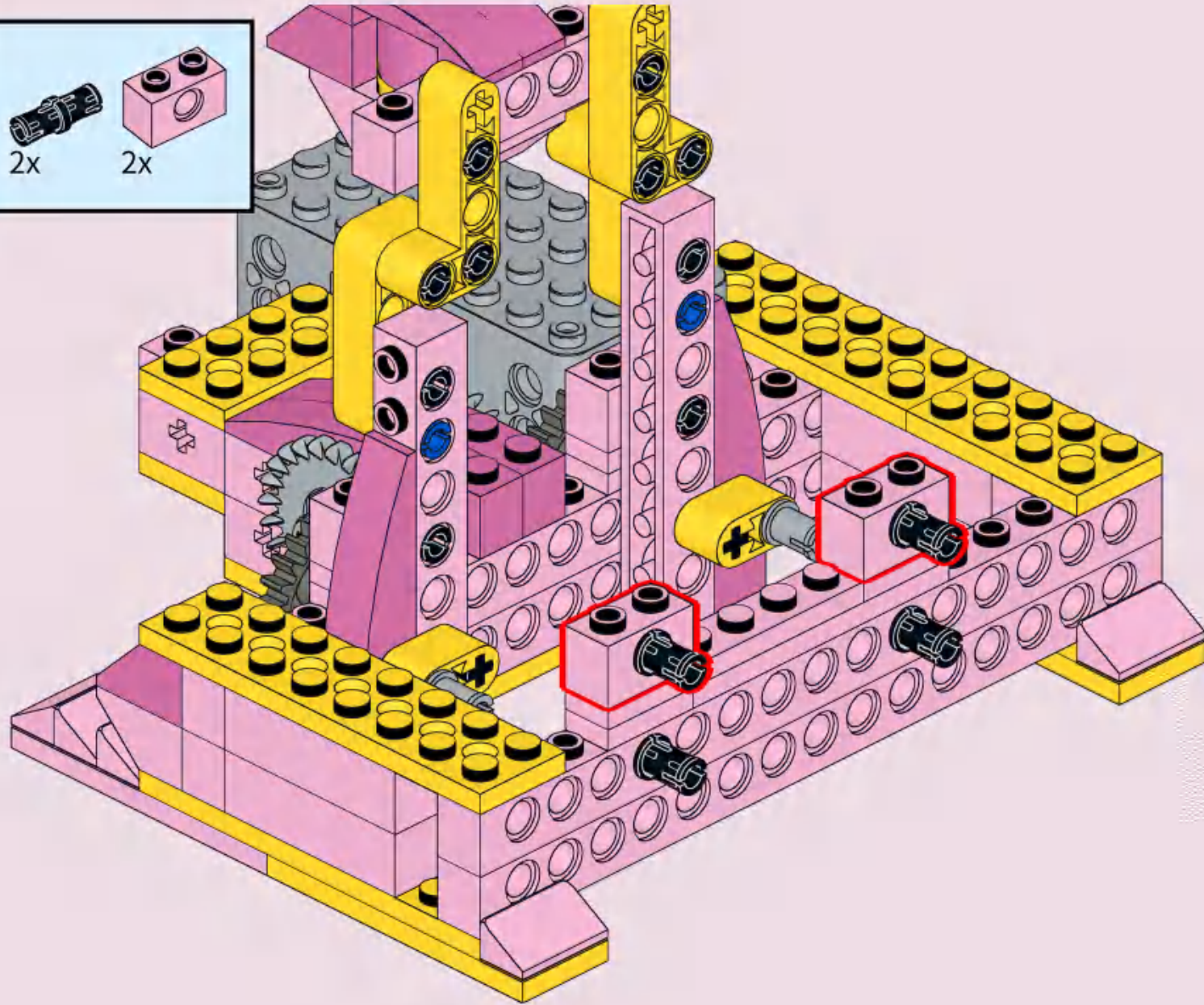
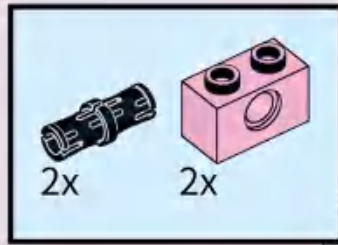



# 34

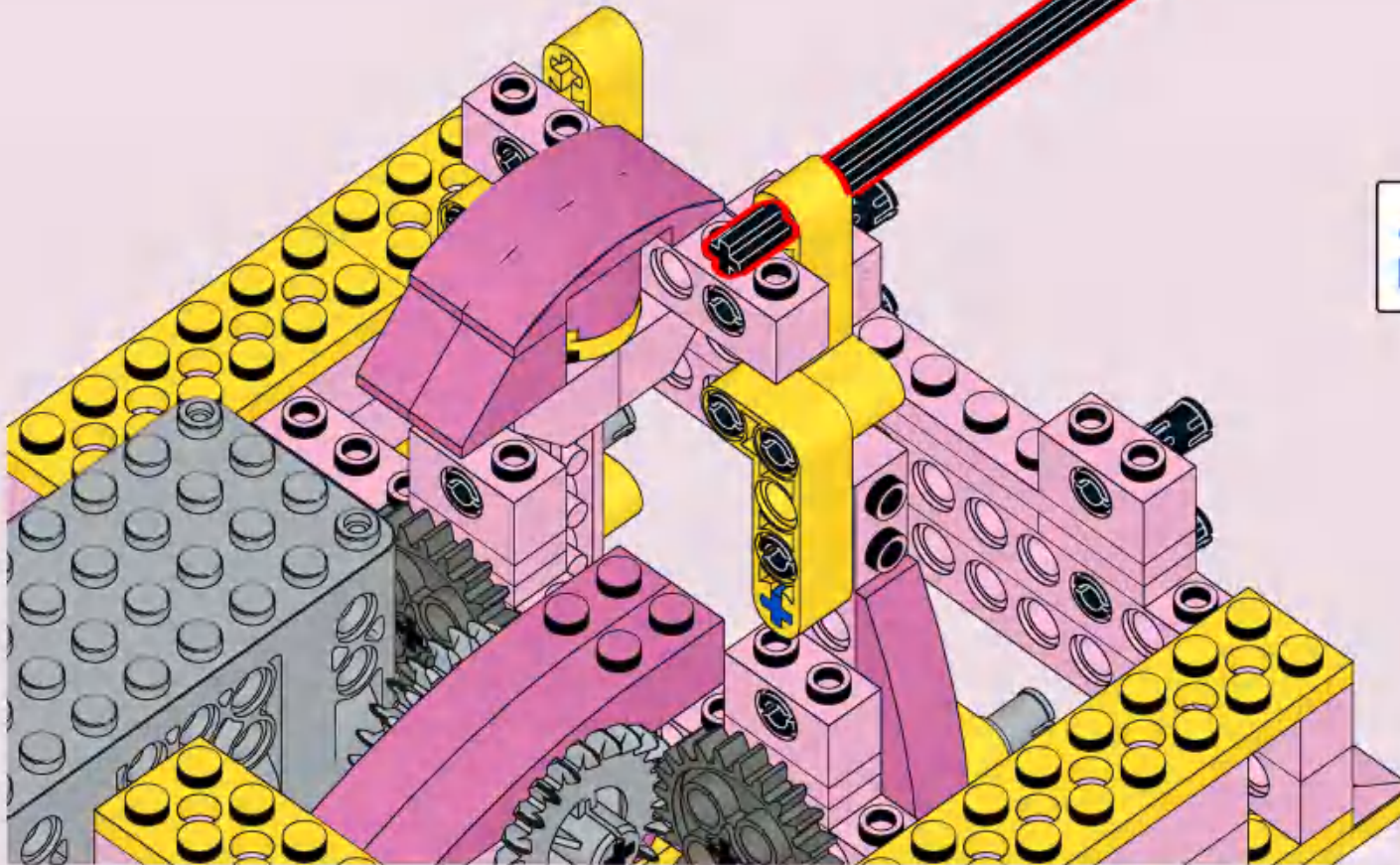
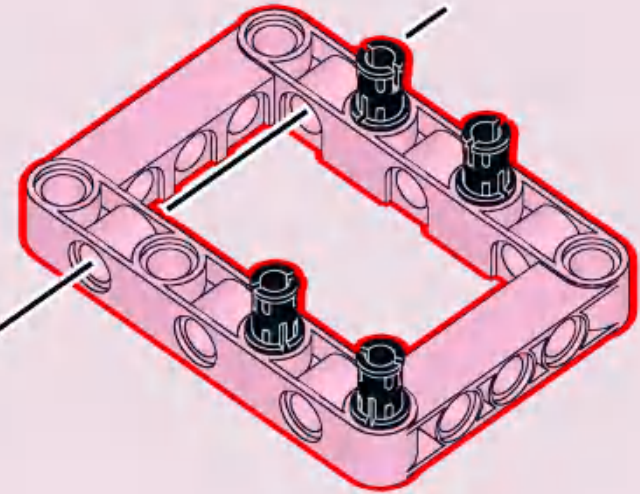
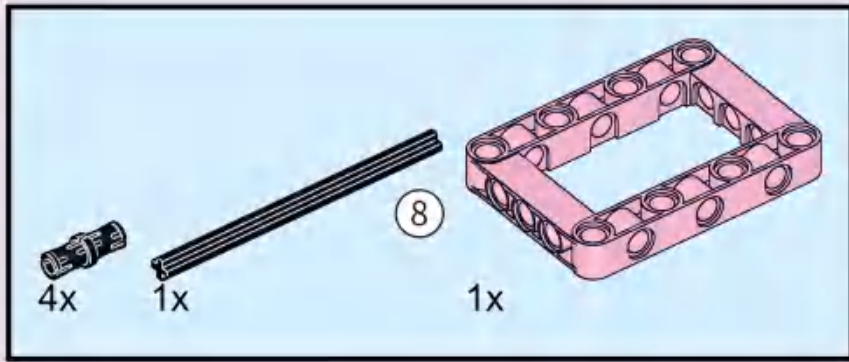

# 35

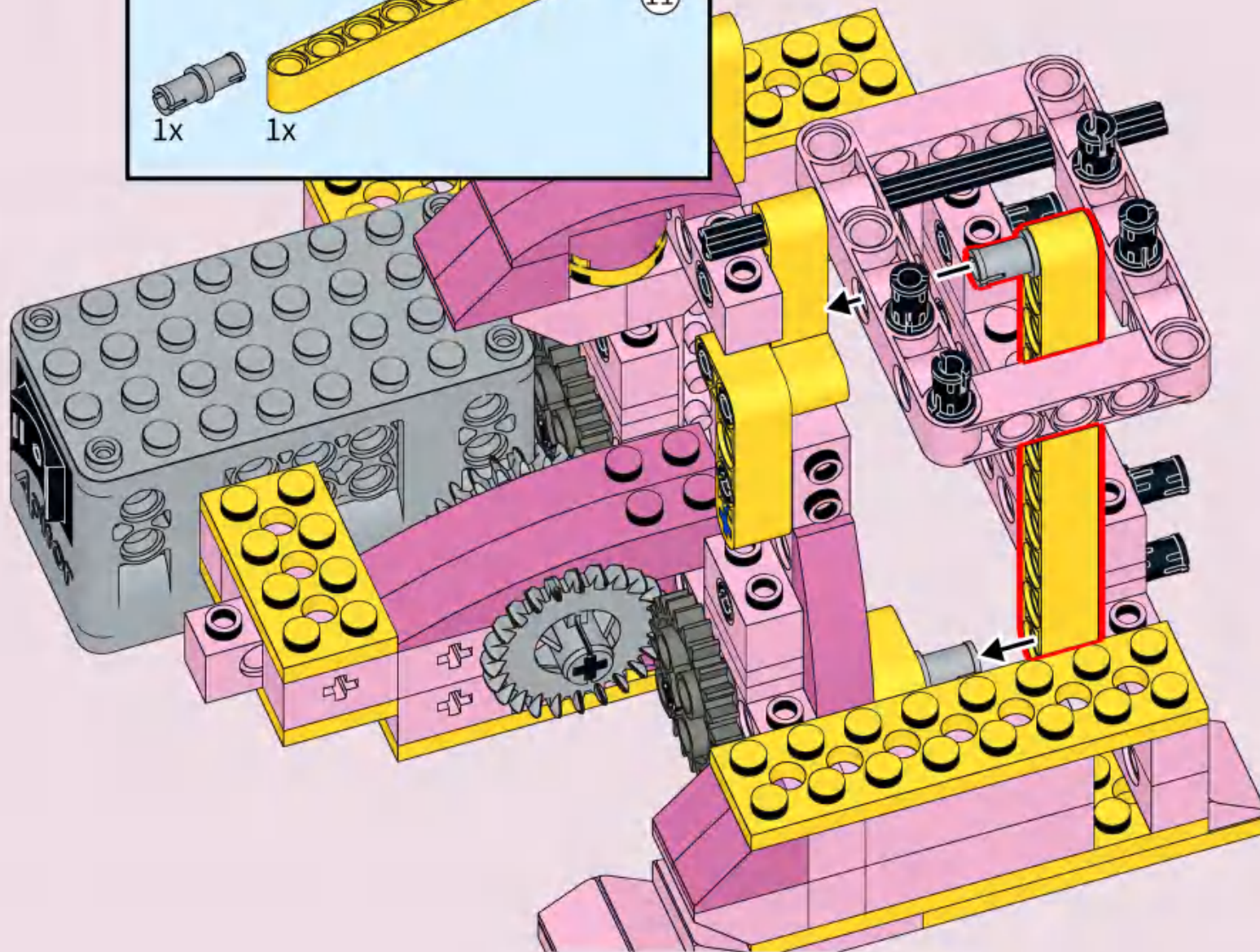
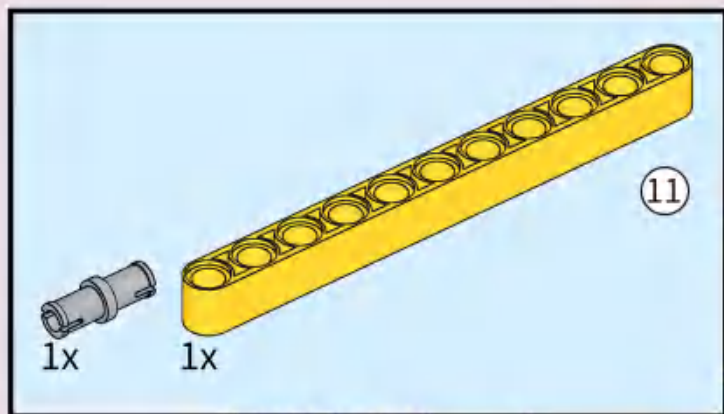



# 36

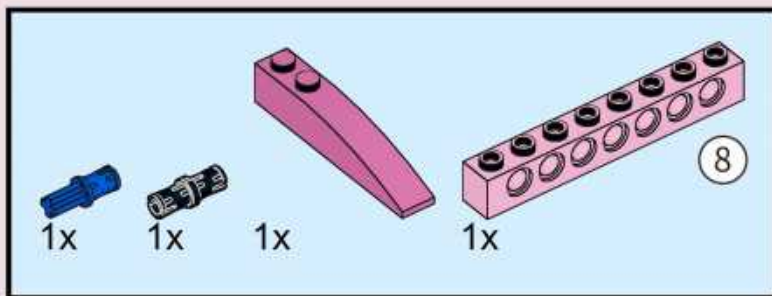

# 37

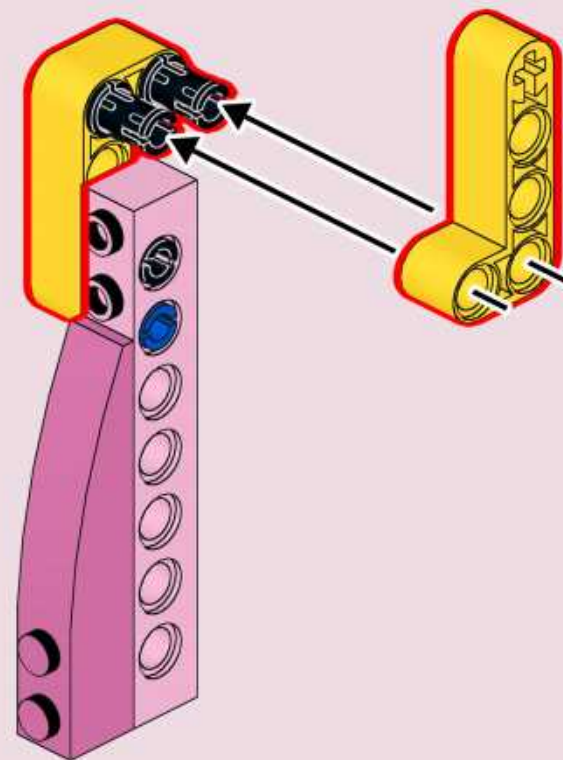
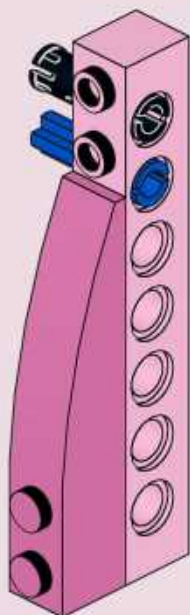
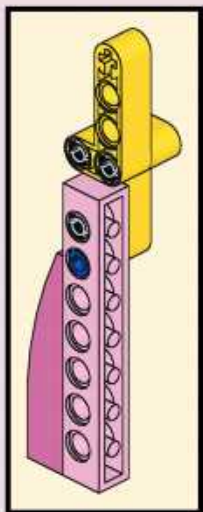
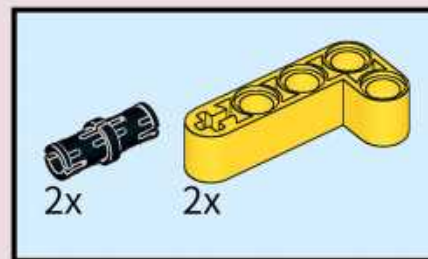



38

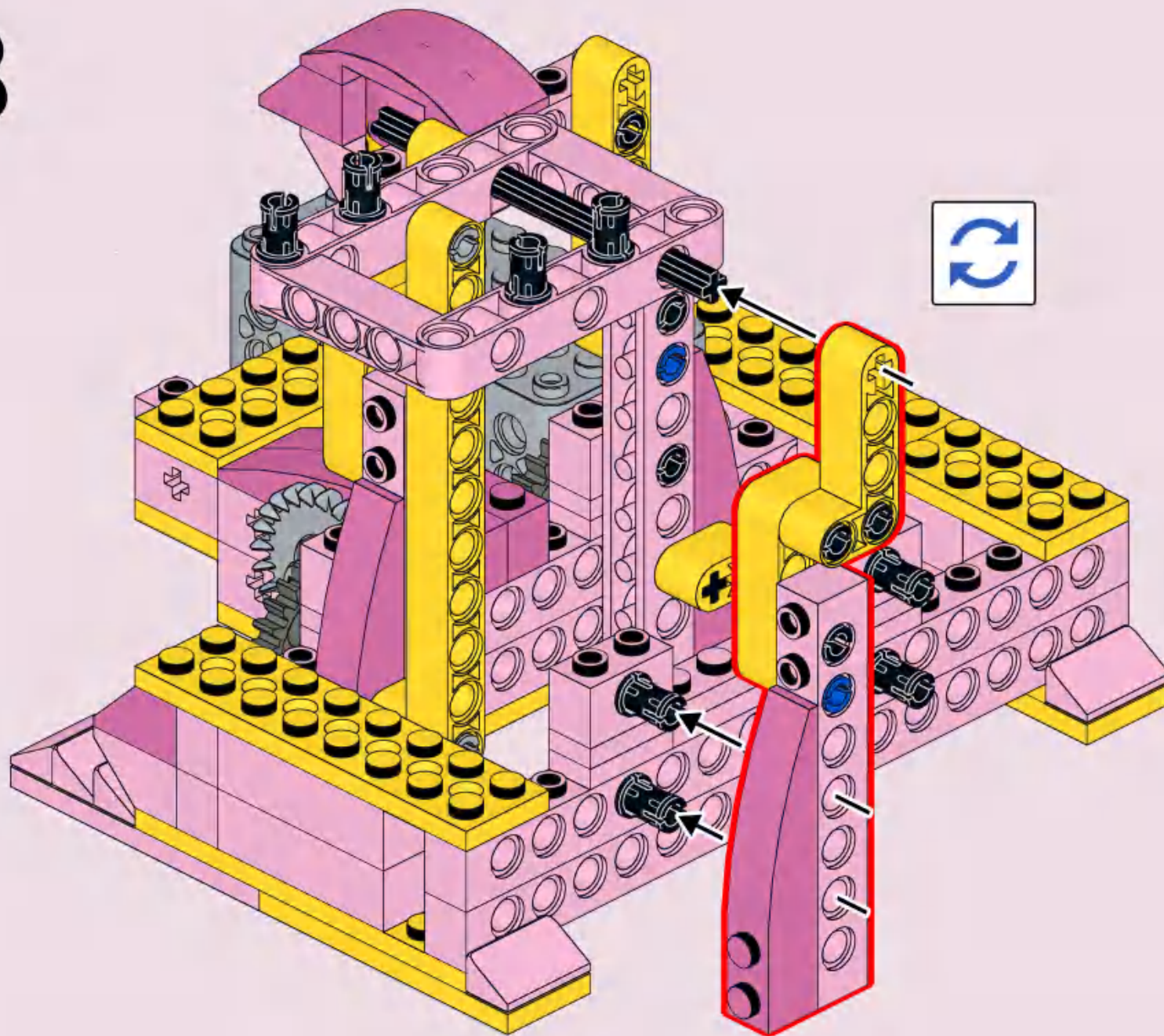

# 39

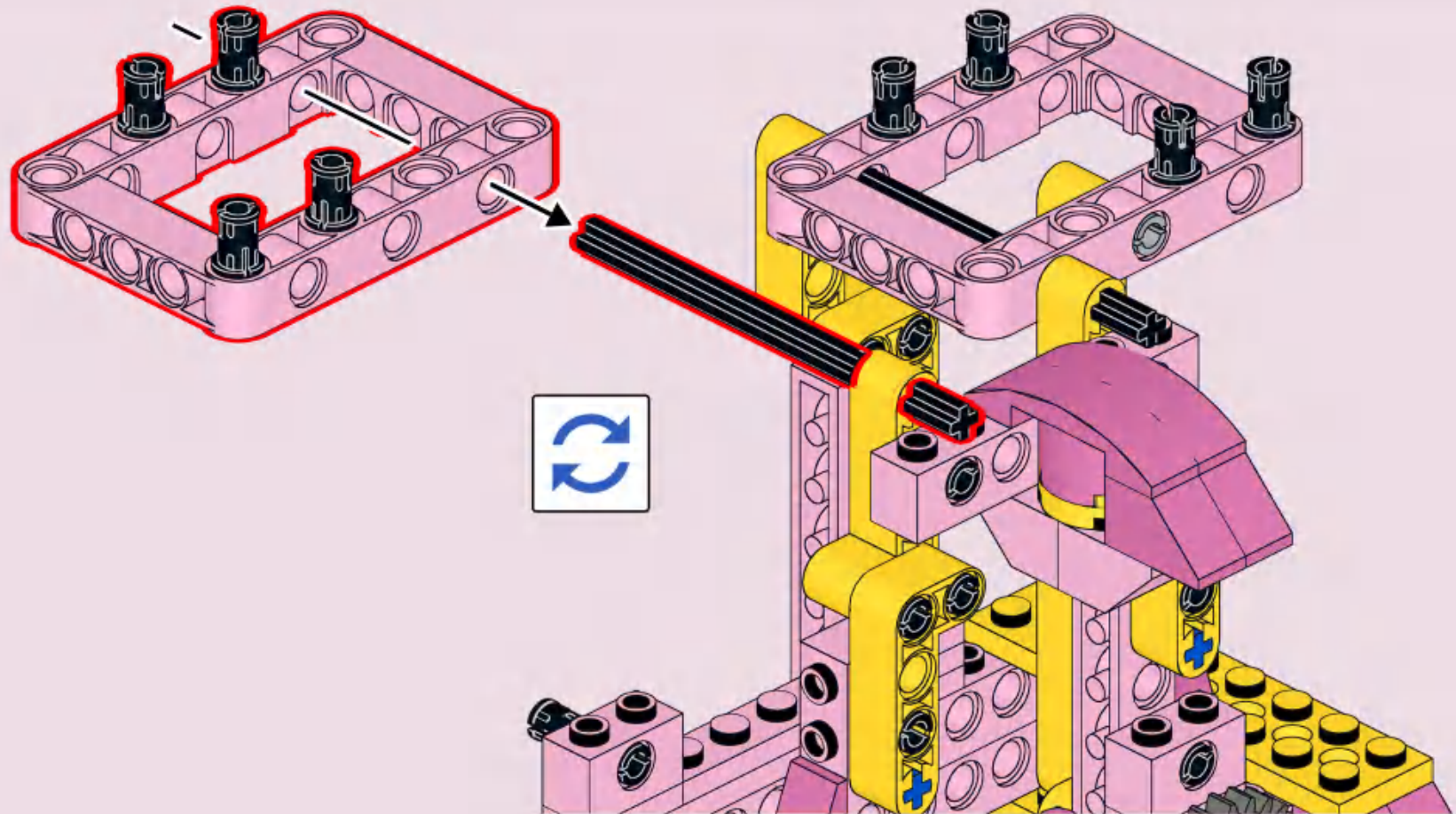
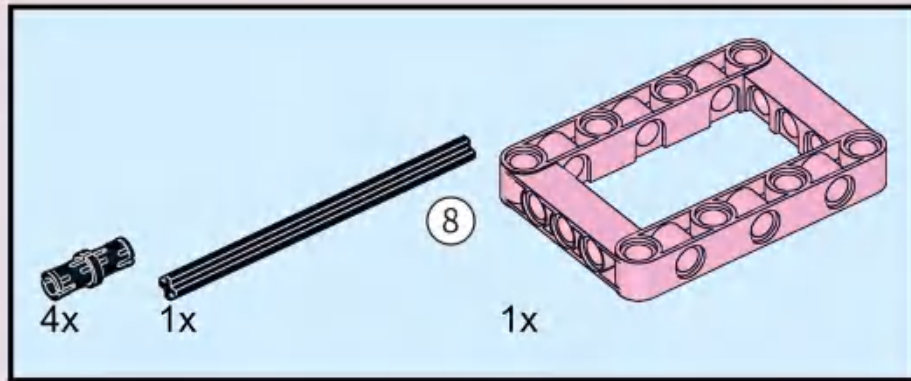



# 40

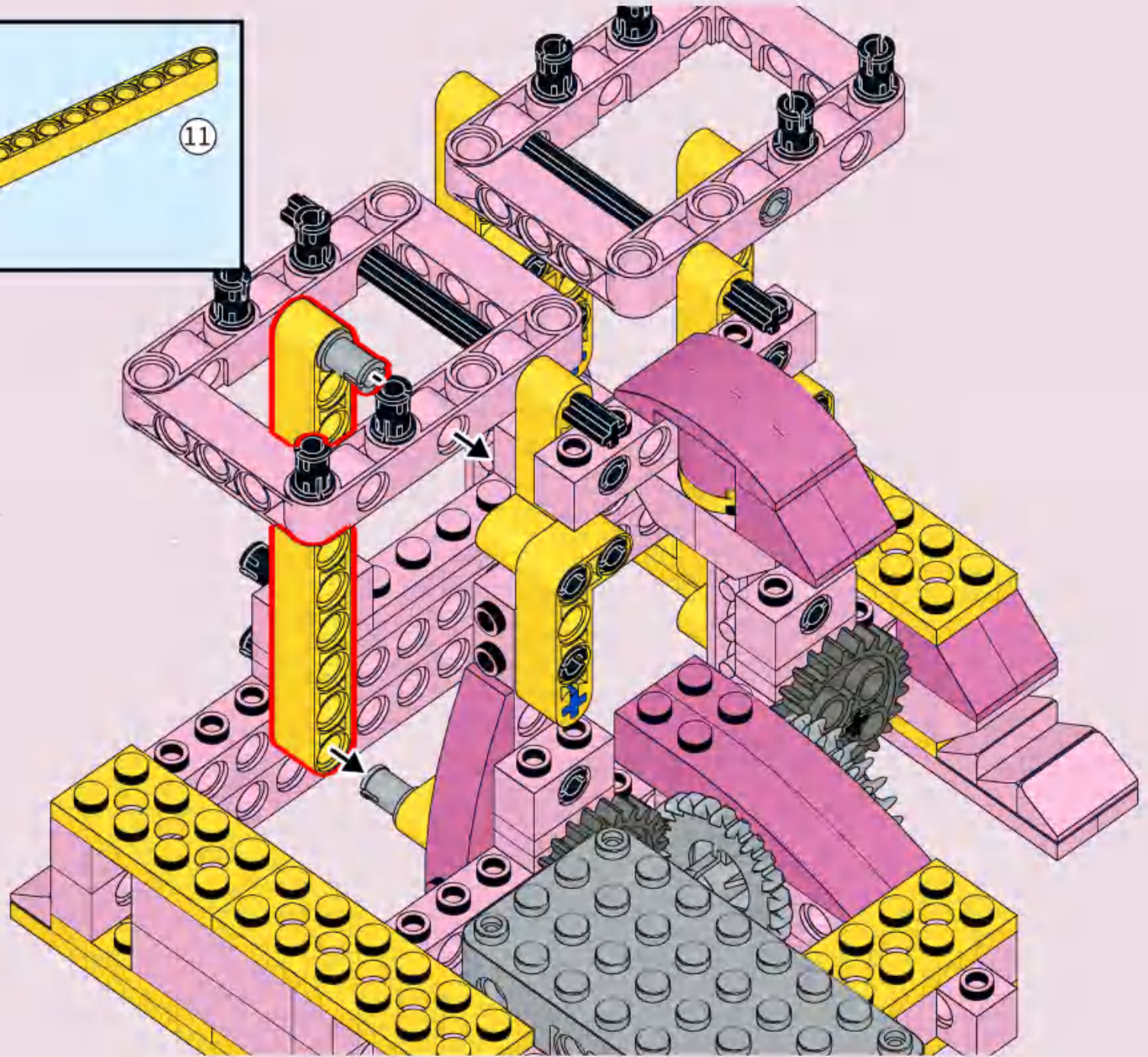
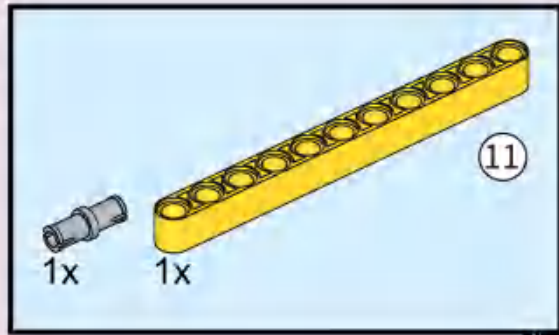



# 41

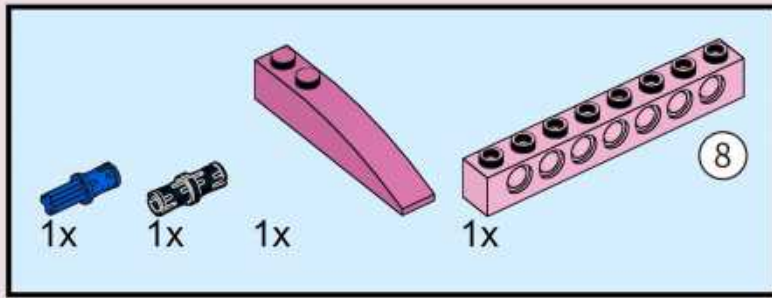

# 42

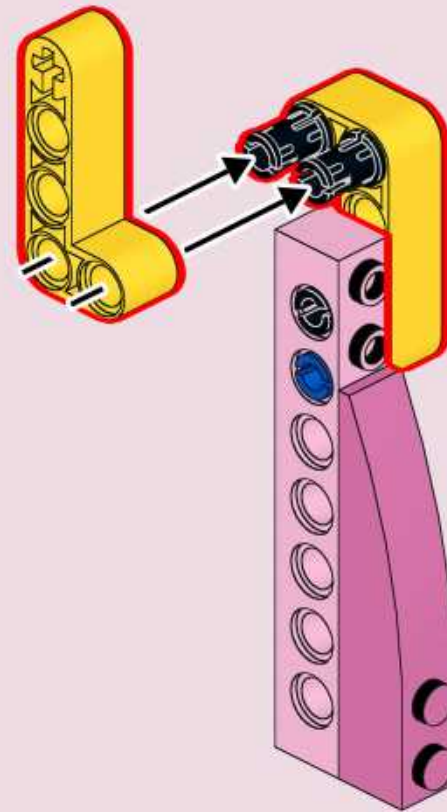
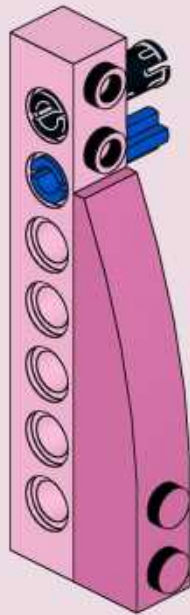
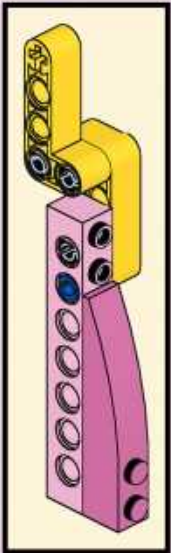
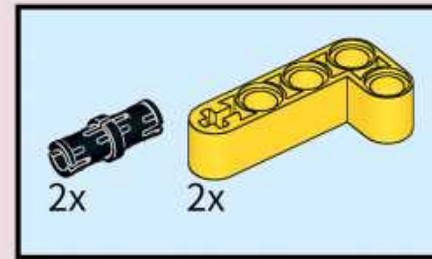

43

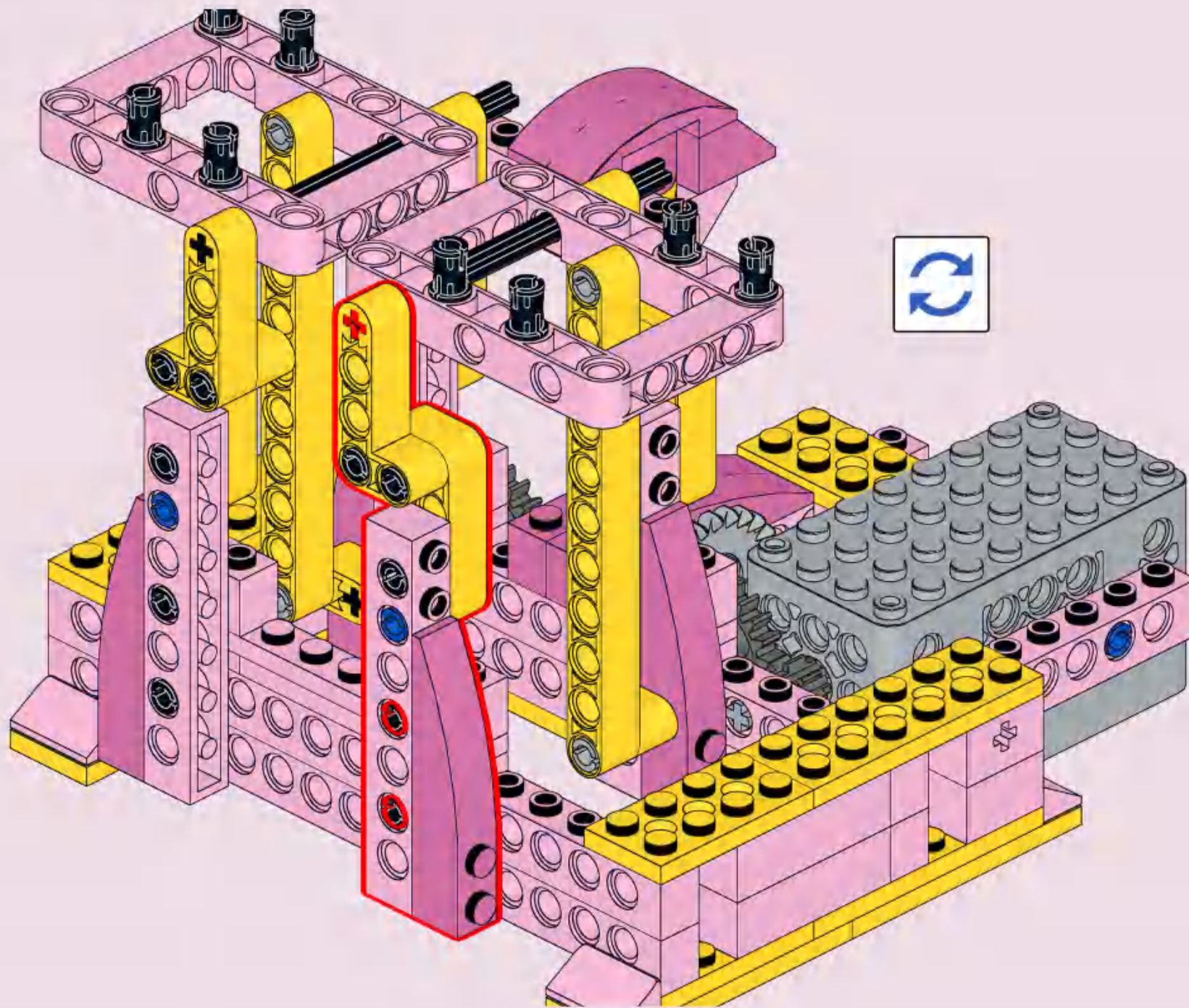

# 44

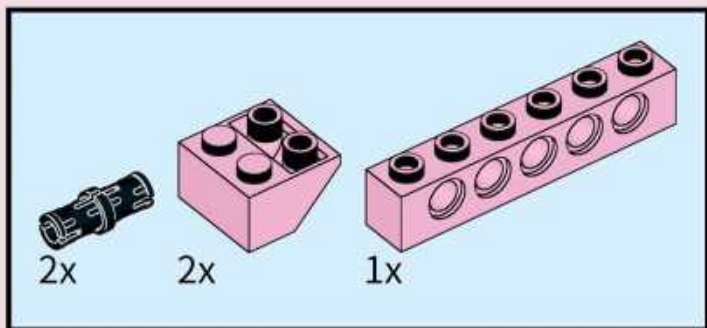

# 45

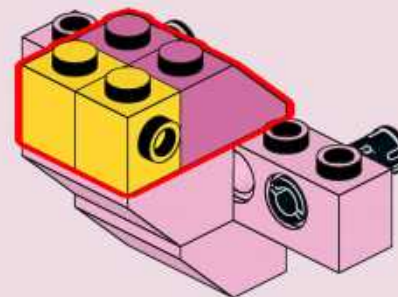
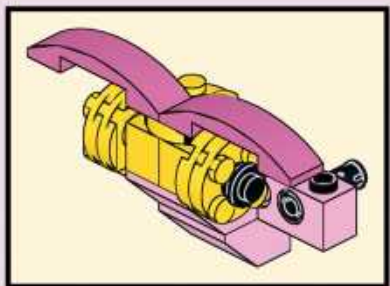
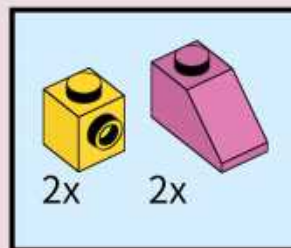



# 46

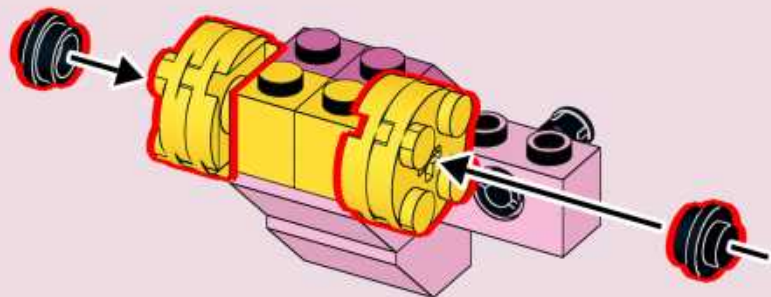
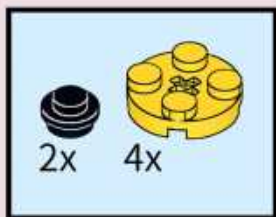

# 47

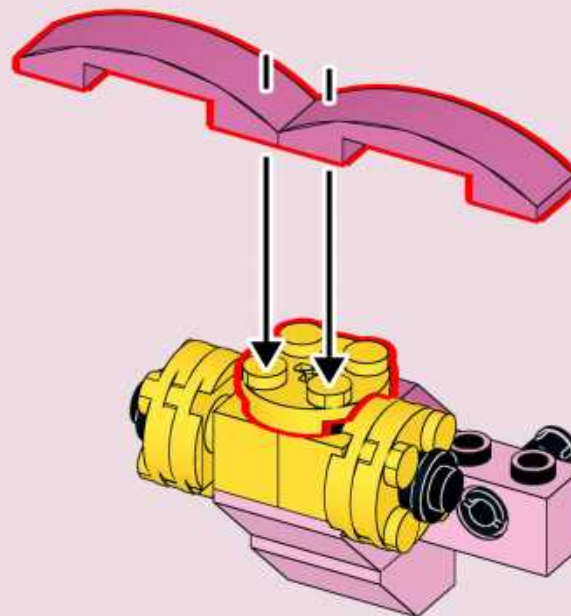
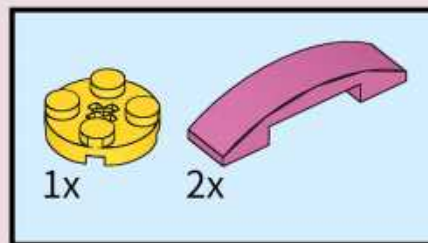

# 48

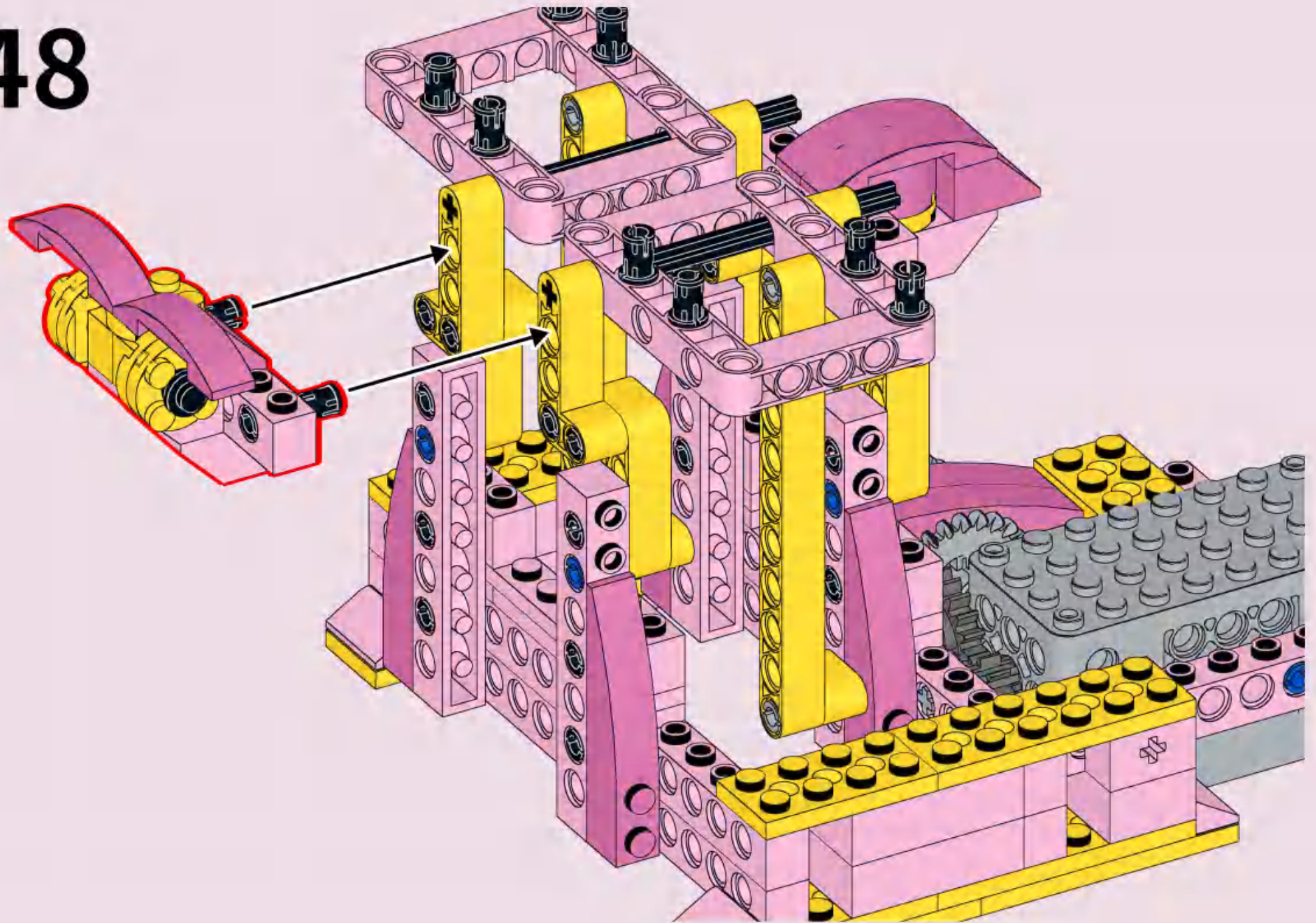

# 49

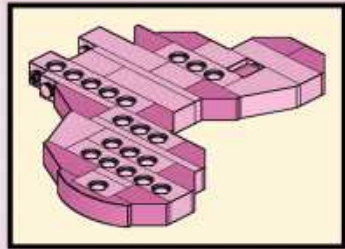
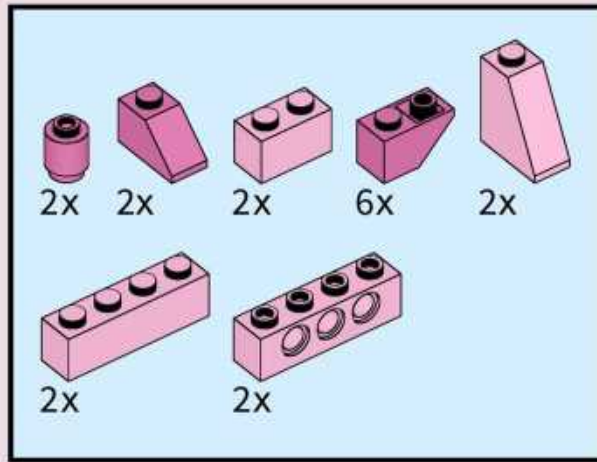

2x

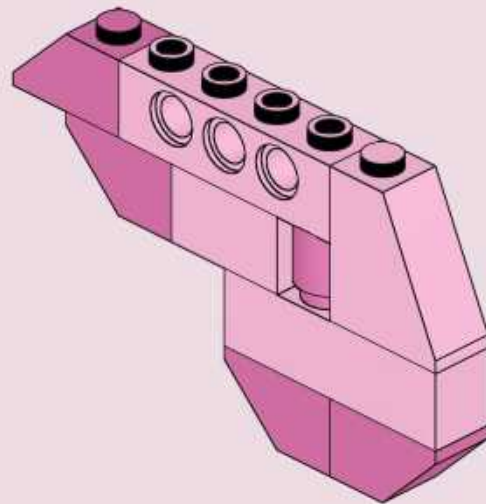

# 50

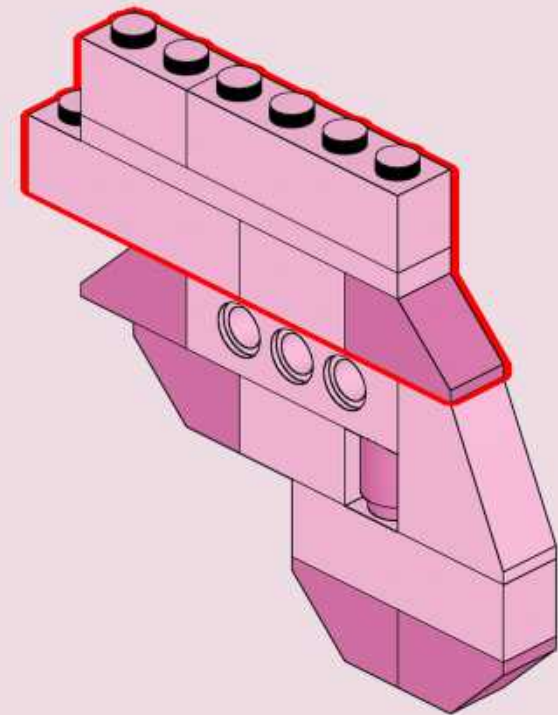
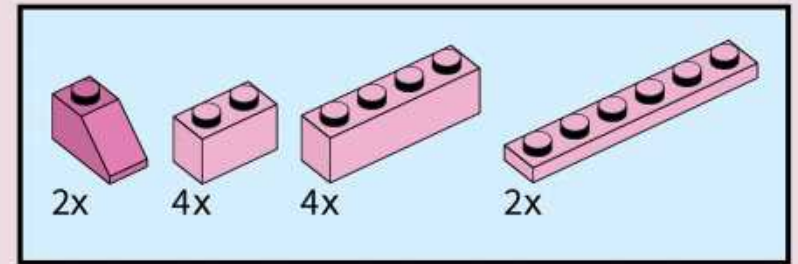



# 51

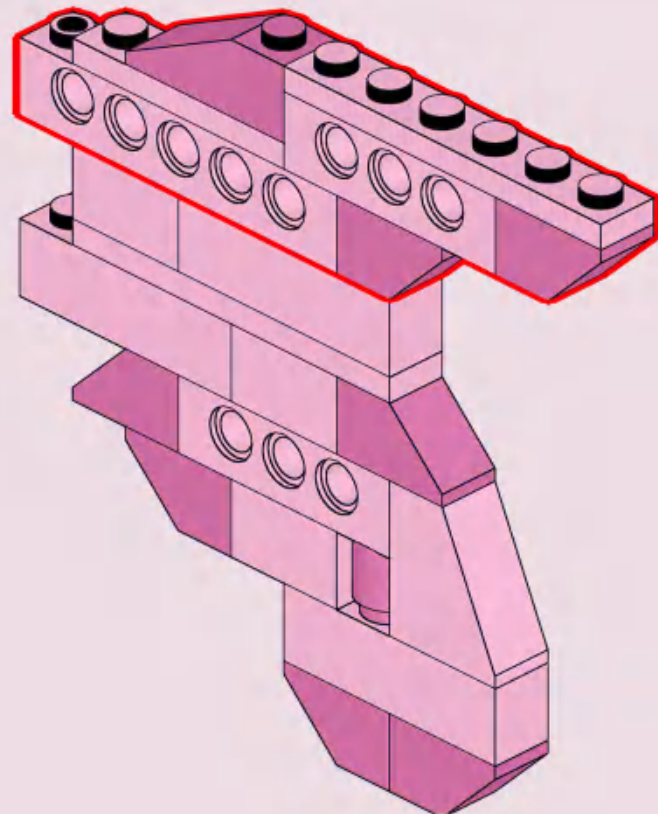
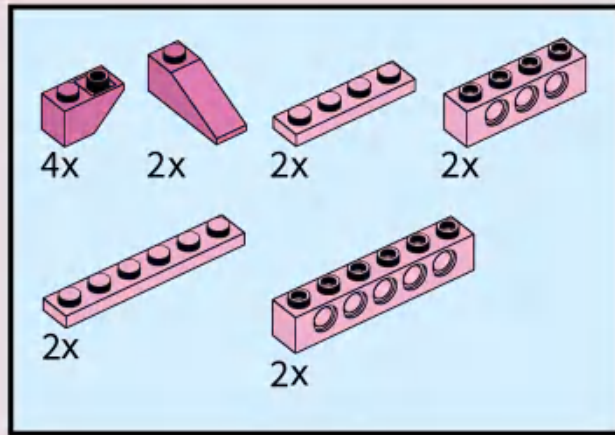

# 52

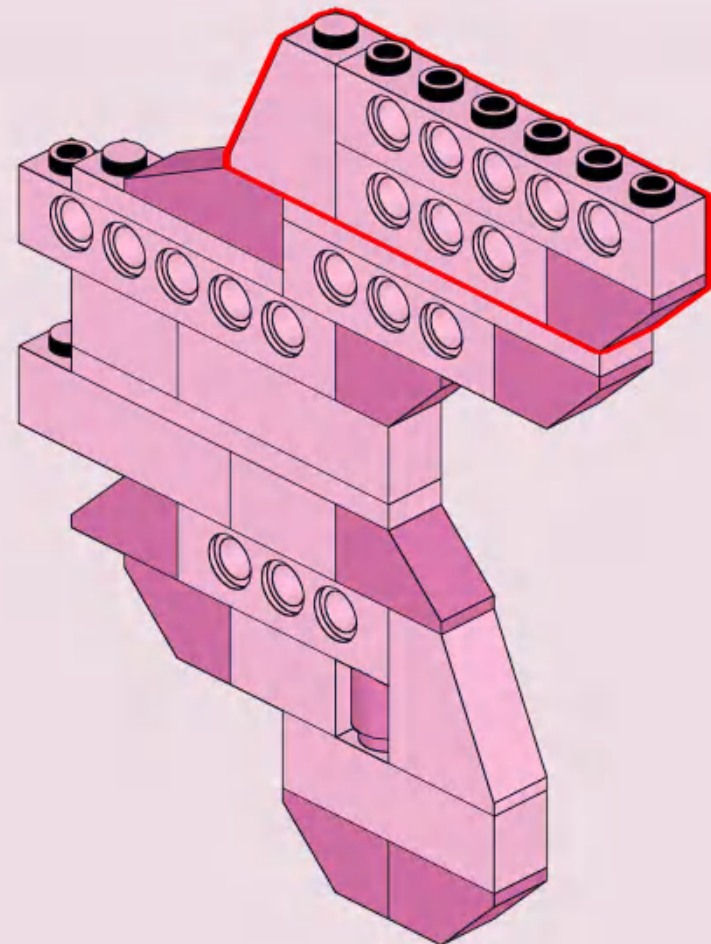
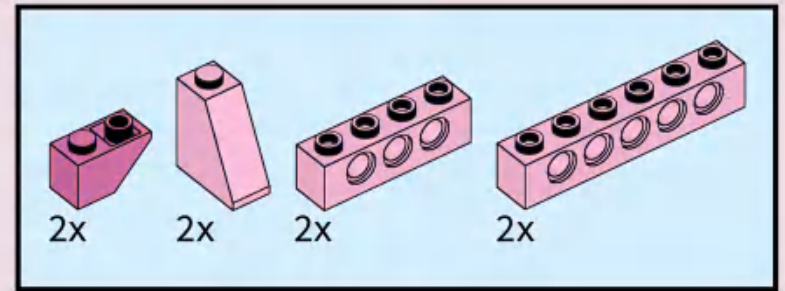

# 53

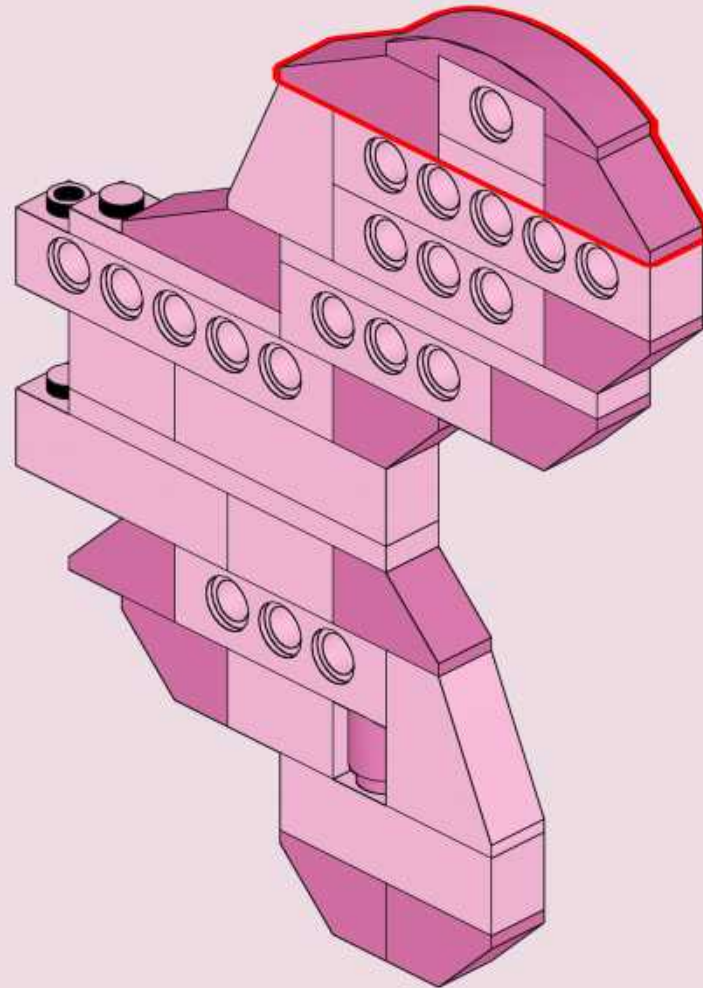
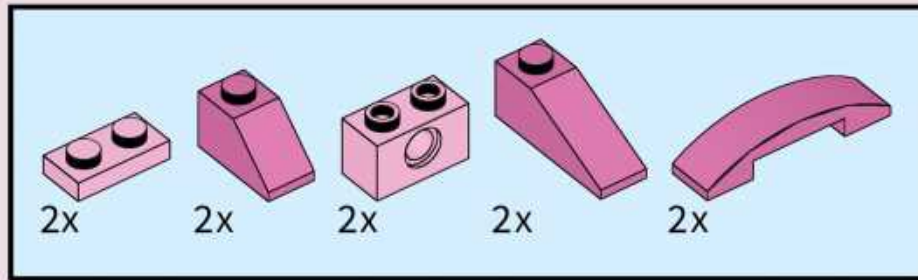

# 54

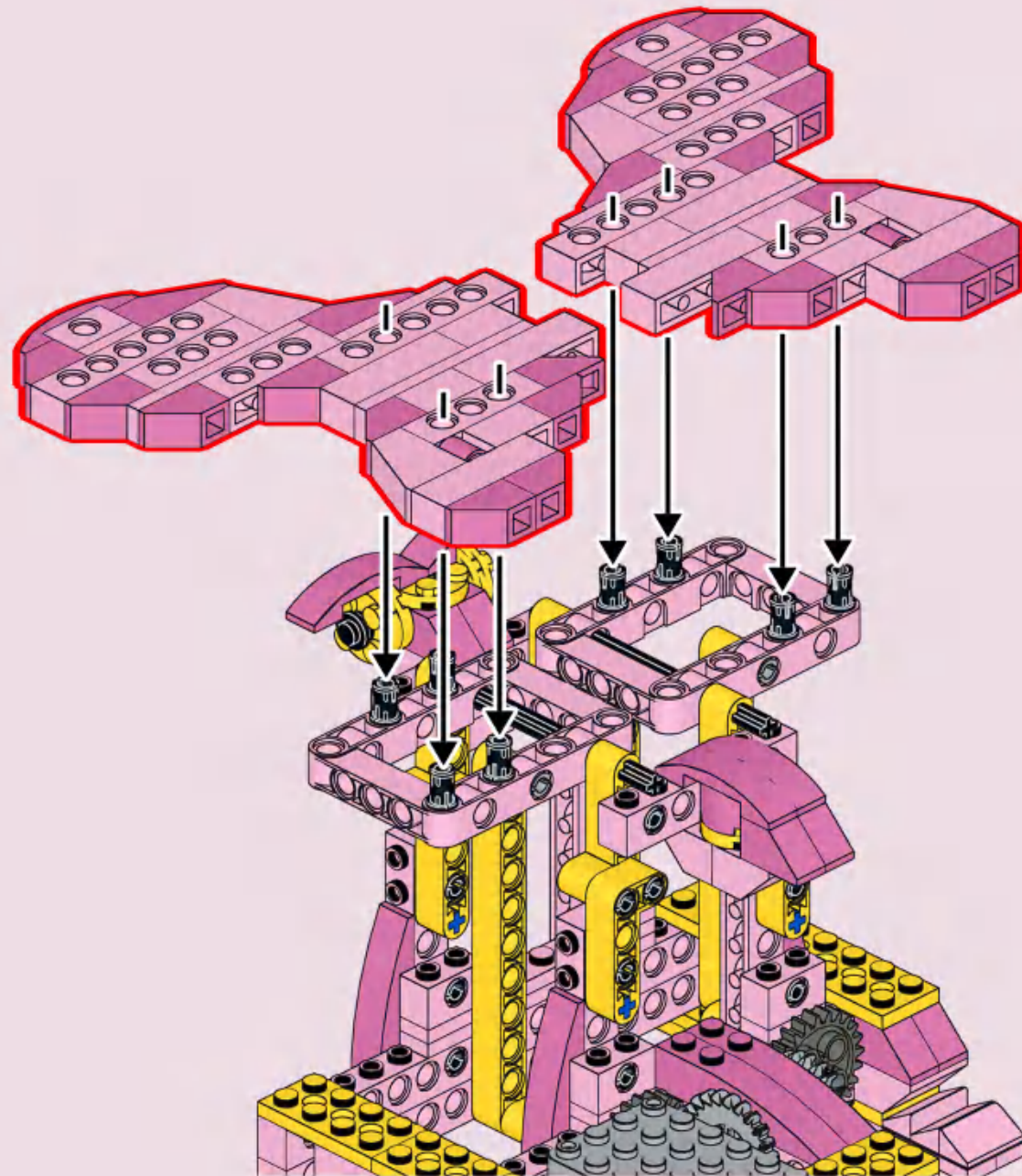



55

