



SPEED
CHAMPIONS

76923



LEGO® Builder



Get excited about our new packaging!

We're switching from plastic to paper-based packaging. That's why you might find a mix of paper and plastic in our boxes!

Nos nouveaux emballages vous emballeront !

Nous passons des emballages en plastique aux emballages à base de papier. C'est pourquoi vous pourriez trouver un mélange de papier et de plastique dans nos boîtes !

¡Te presentamos nuestros nuevos empaques!

Estamos sustituyendo las bolsas de plástico por bolsas con base de papel. ¡Por eso, puedes encontrar una mezcla de papel y de plástico en nuestras cajas!

[LEGO.com/sustainable-packaging](https://www.lego.com/sustainable-packaging)

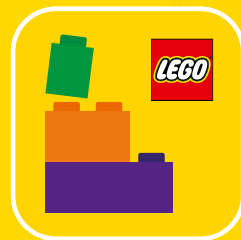

Q LEGO® Builder

BUILDER



Apple and the Apple logo are trademarks of Apple Inc., registered in the U.S. and other countries and regions. App Store is a service mark of Apple Inc. Google Play and the Google Play logo are trademarks of Google LLC. Tencent and the Tencent logo are trademarks of Tencent Inc.

Q [LEGO.com/devicecheck](https://www.lego.com/devicecheck)

EN Ask parents' permission before going online | **DE** Eltern um Erlaubnis bitten, bevor du online gehst | **FR** Demande l'autorisation d'un parent avant d'aller en ligne | **IT** Chiedi il permesso ai tuoi genitori prima di andare online | **ES** Pídeles permiso a tus papás antes de conectarte a Internet | **PT** Pede autorização aos pais antes de acederes online | **ZH** 上网前应先征得父母的同意 | **PL** Poproś rodziców o zgodę, zanim wejdziesz do Internetu | **CS** Než půjdeš na internet, požádej rodiče o svolení | **SK** Skôr než pôjdeš na internet, vypýtaj si povolenie od rodičov | **HU** Kérj szülői engedélyt, mielőtt online csatlakoznál! | **RO** Cere permisiunea părinților înainte de a te conecta online | **BG** Поискайте разрешение от родител, преди да влезете онлайн | **LV** Pirms došanās tiešsaistē palūdz atļauju vecākiem | **ET** Enne Interneti kasutamist küsi vanematelt luba | **LT** Prieš prisijungdami prie interneto, atsiklauskite tėvų



1

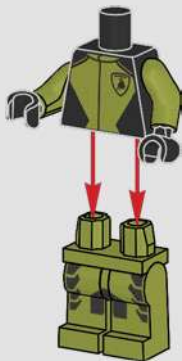

2





3

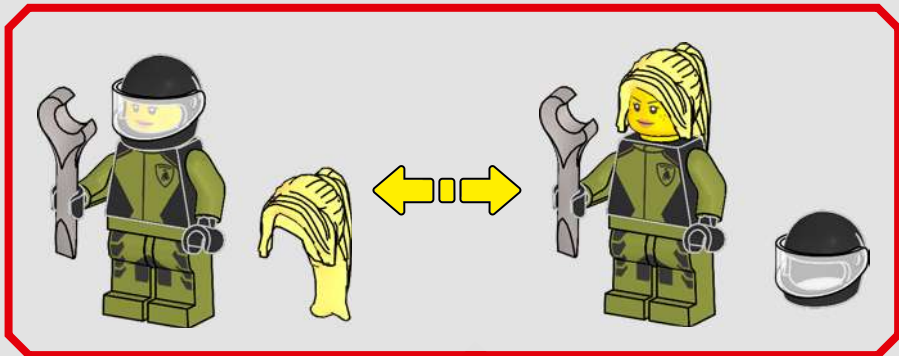

4



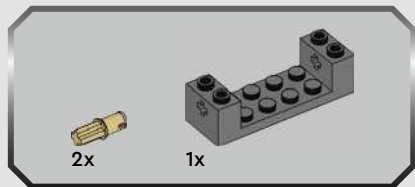

1

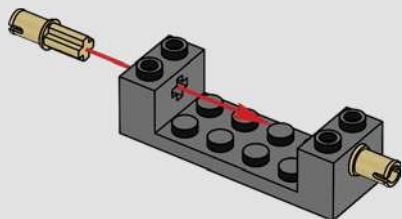

2

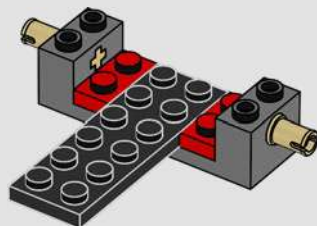



3

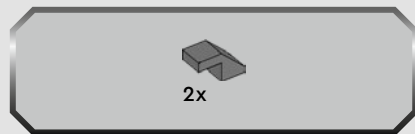
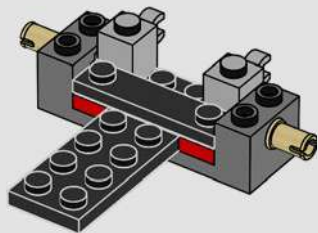

4

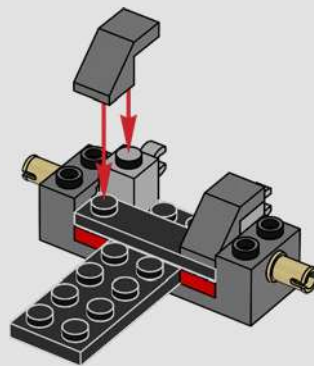

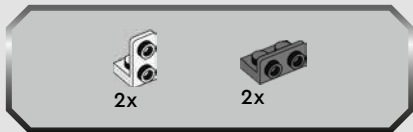

5

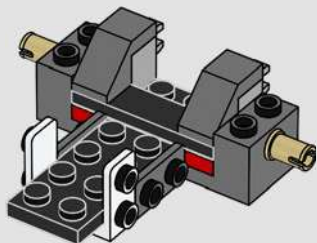

6

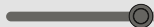
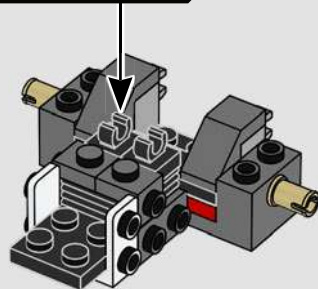
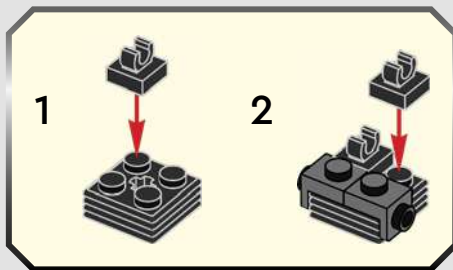

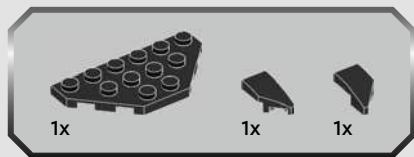

7

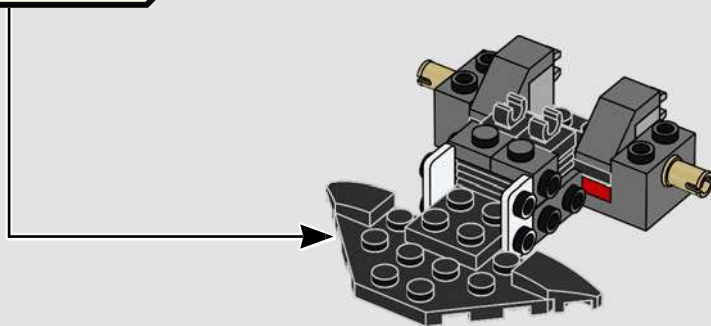
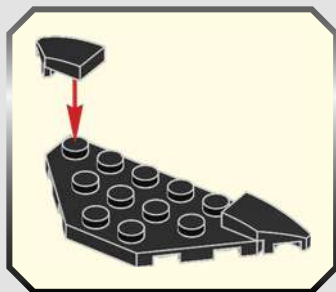

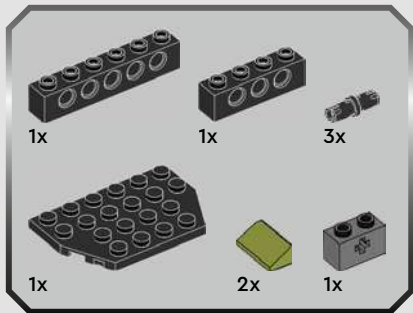

8

1



2

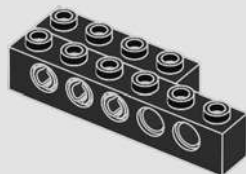

3

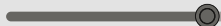
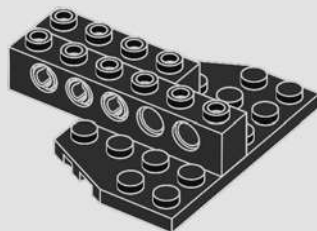

4

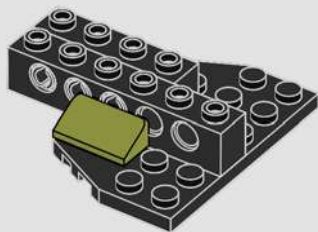

5

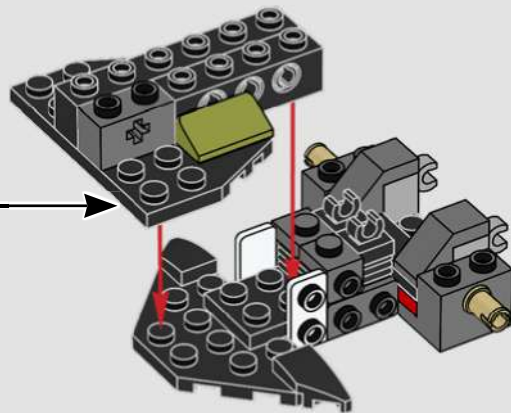



9

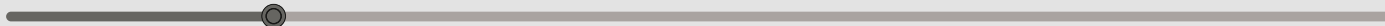
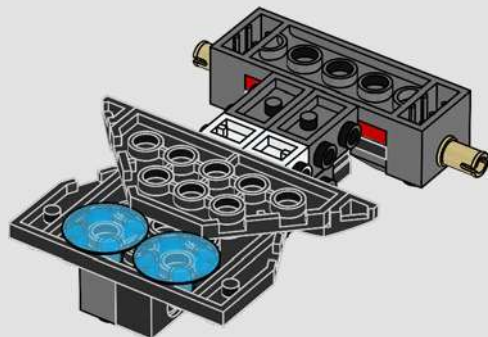



10

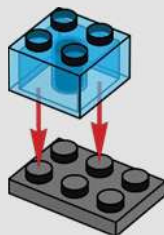

11



12





1x



1x

13

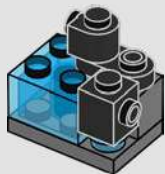

2x

14

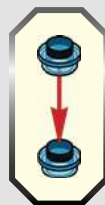



15

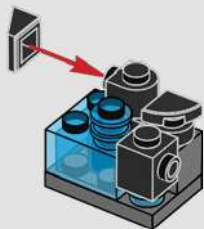

16

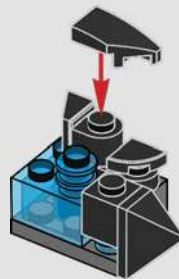



17

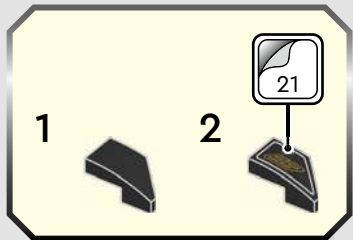

18

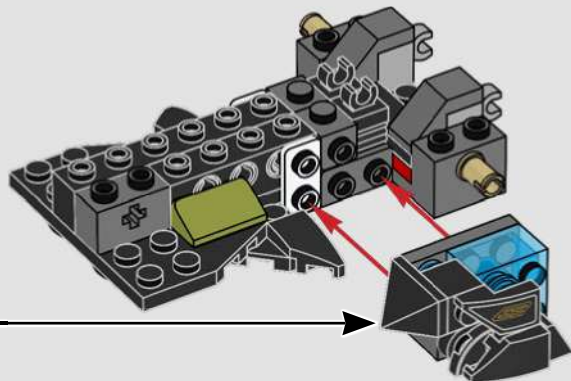



19

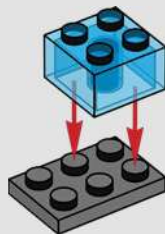

20



21

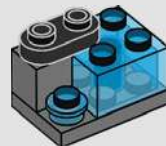



1x



1x

22



2x

23

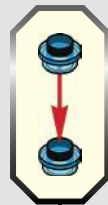

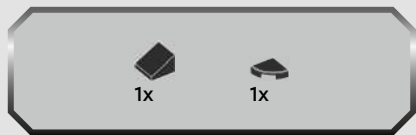

24

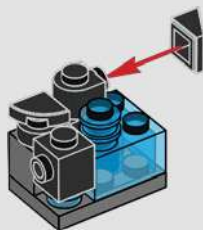

25





26

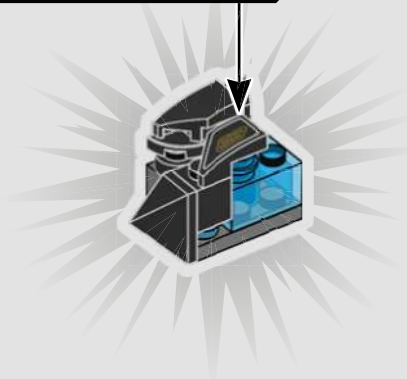
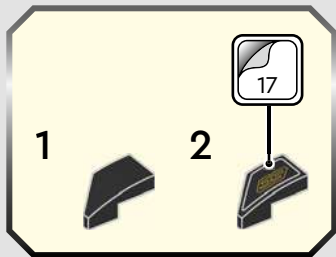

27

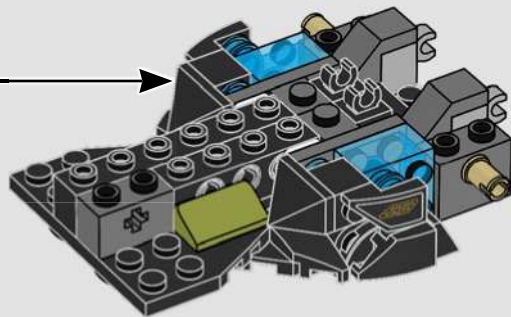

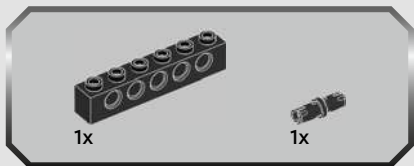

28

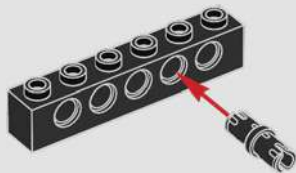

29



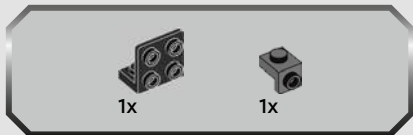

30

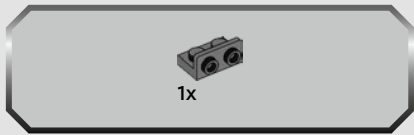
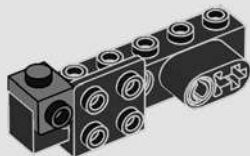

31

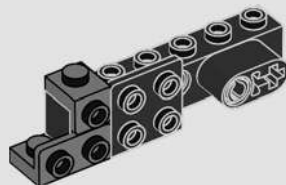



32

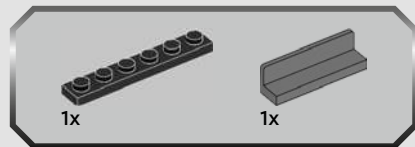
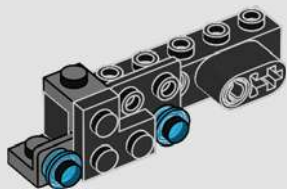

33

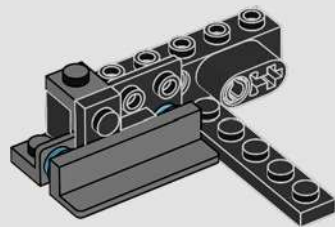

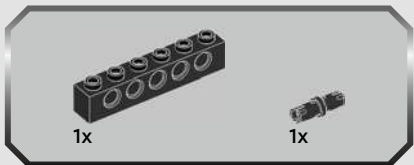

34

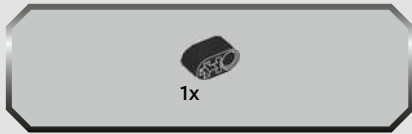
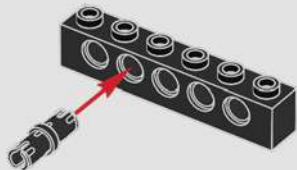

35

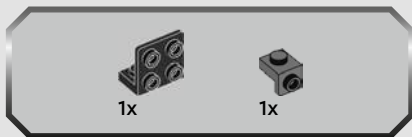

36

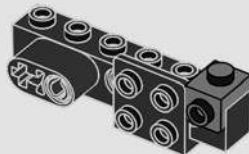

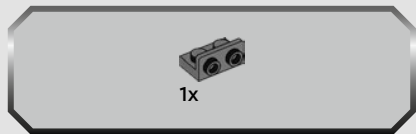

37

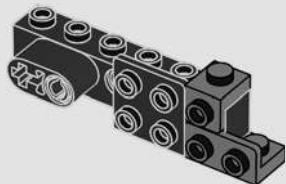

38

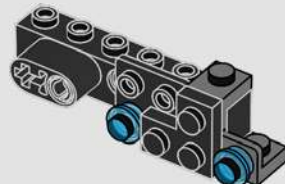

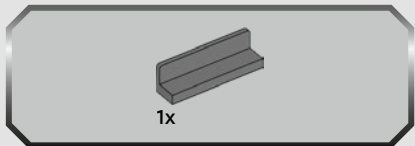

39

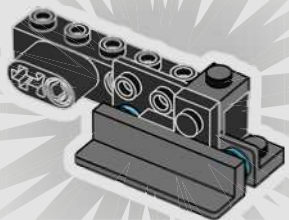

40

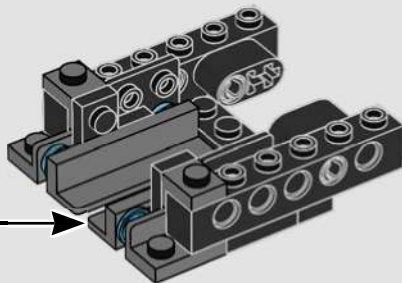

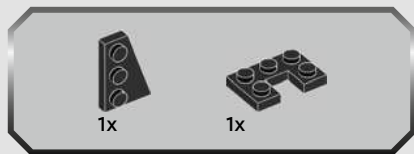

41

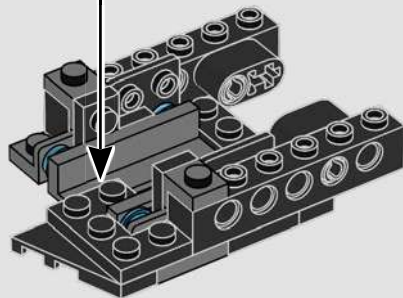
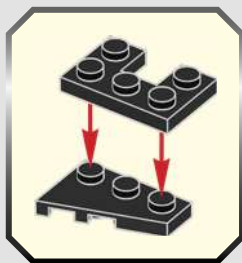

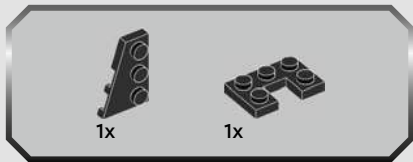

42

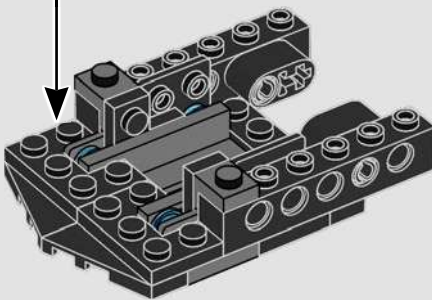
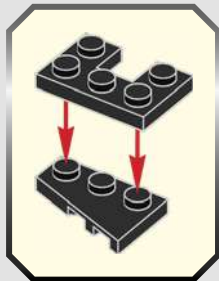



43

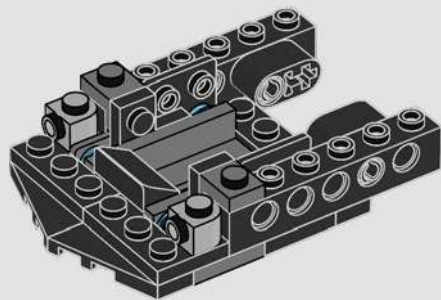

44

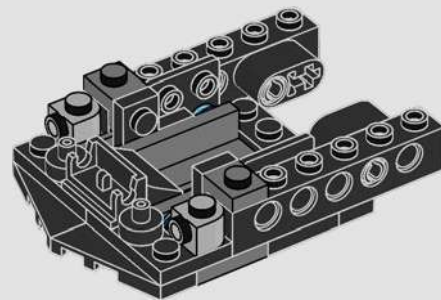



45

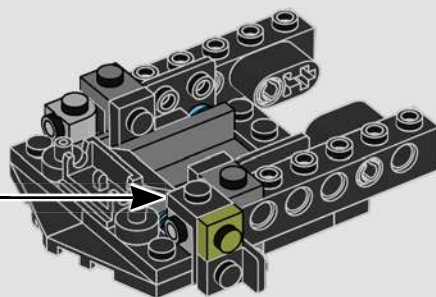
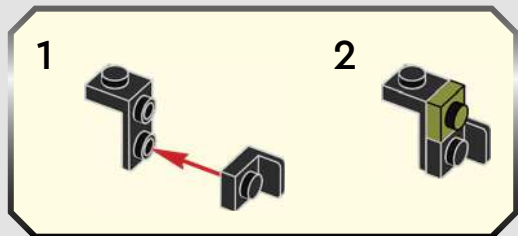



46

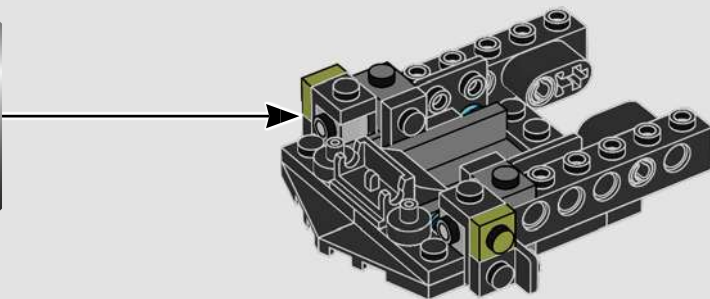
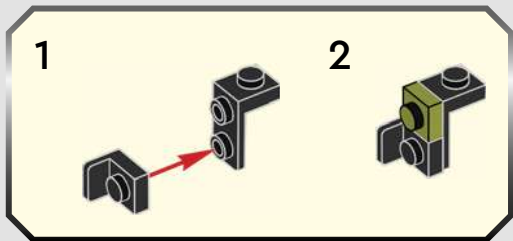



47

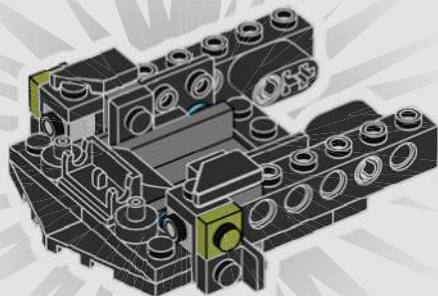

48

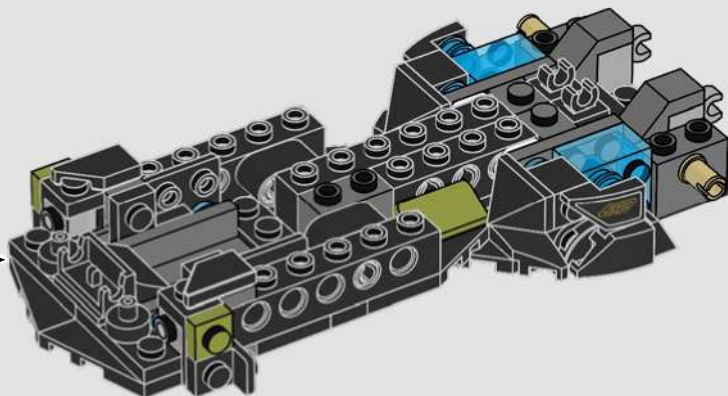

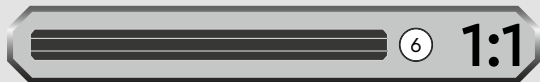
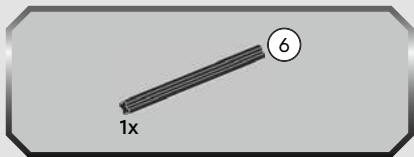

49

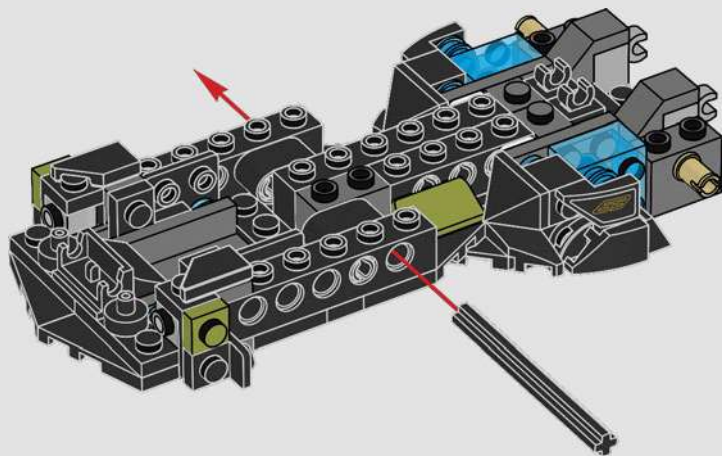

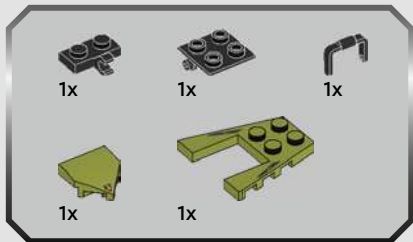

50

1

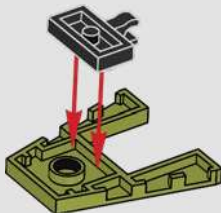

2

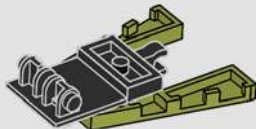

3

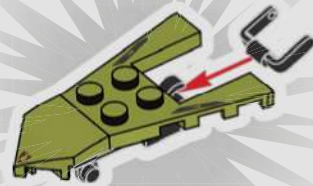

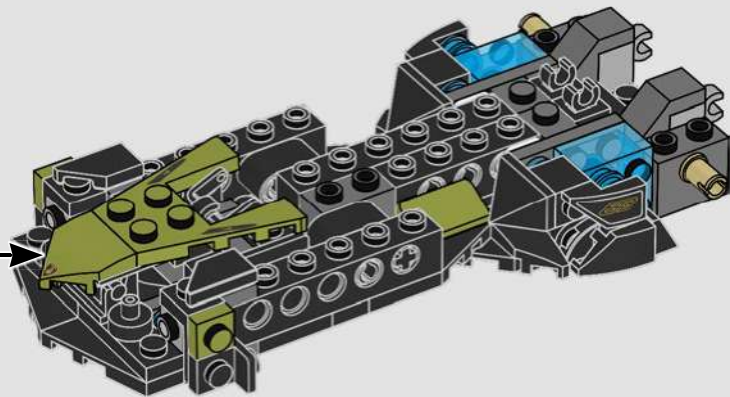

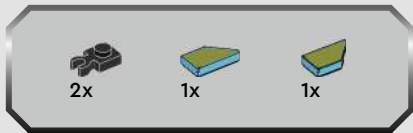

51

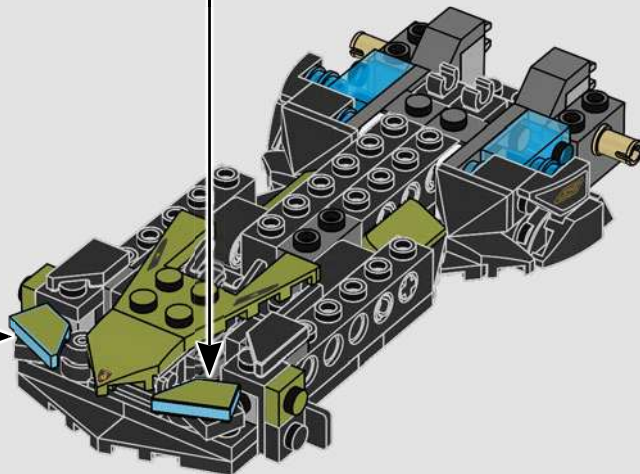

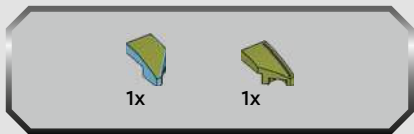

52

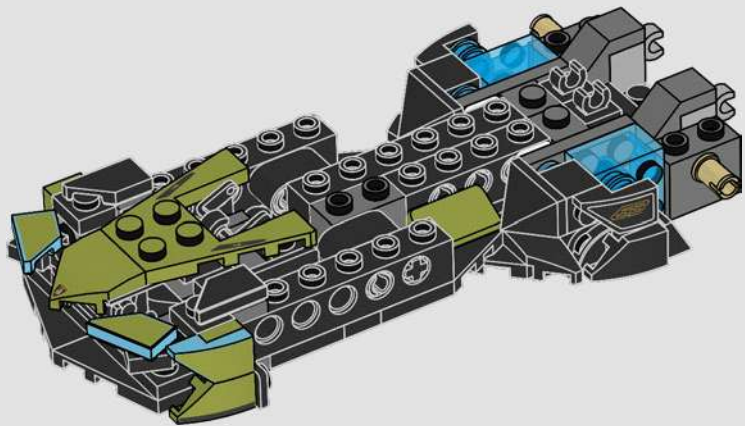



1x



1x

53

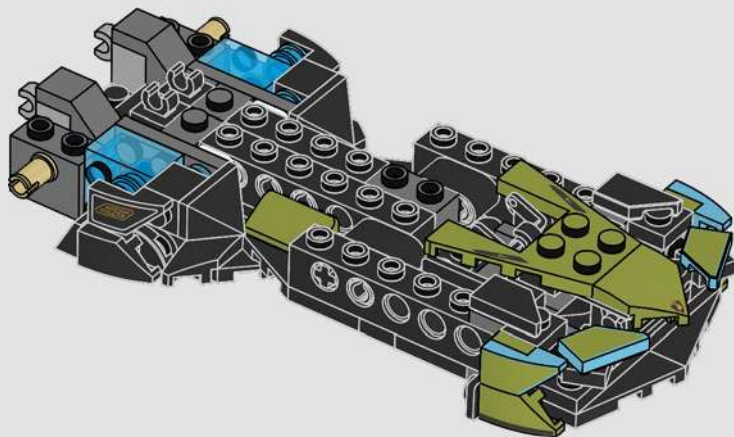





54

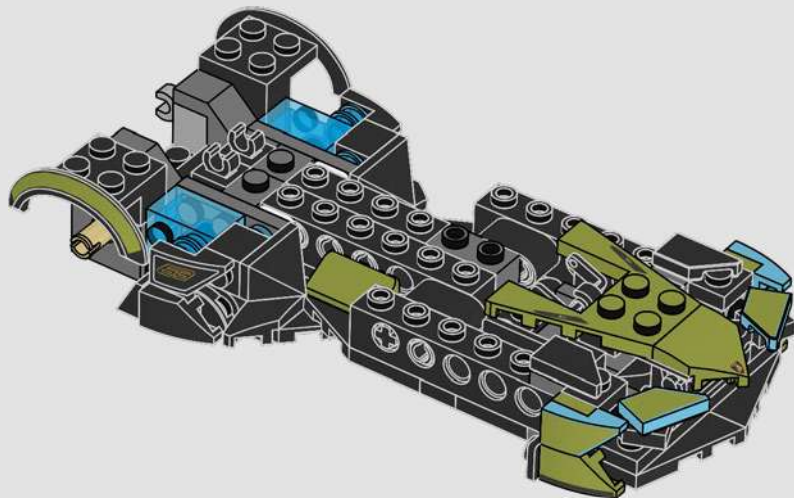



55

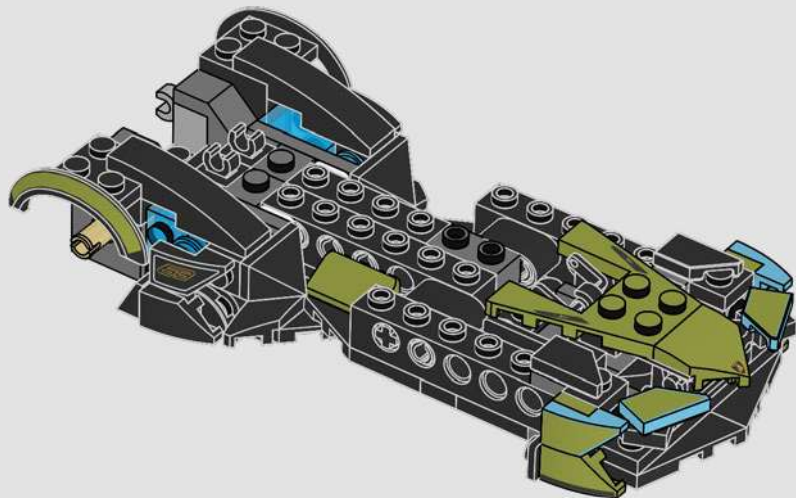

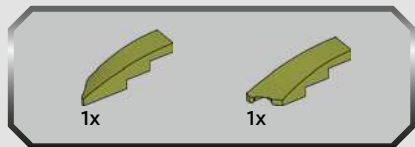

56

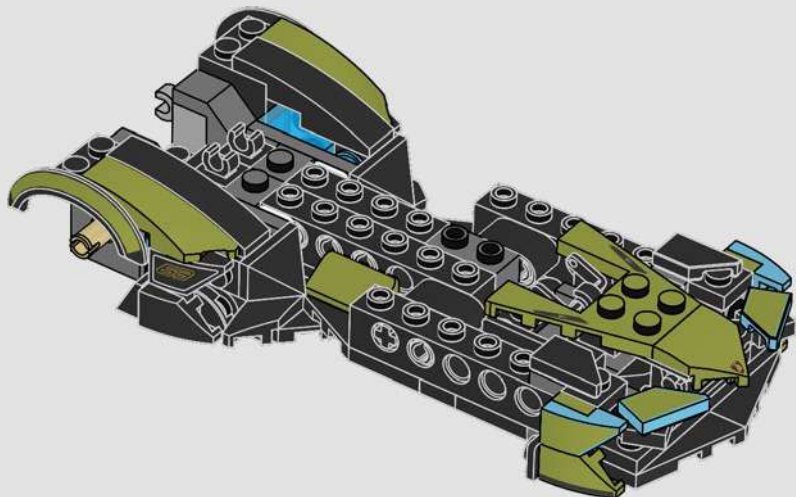

57

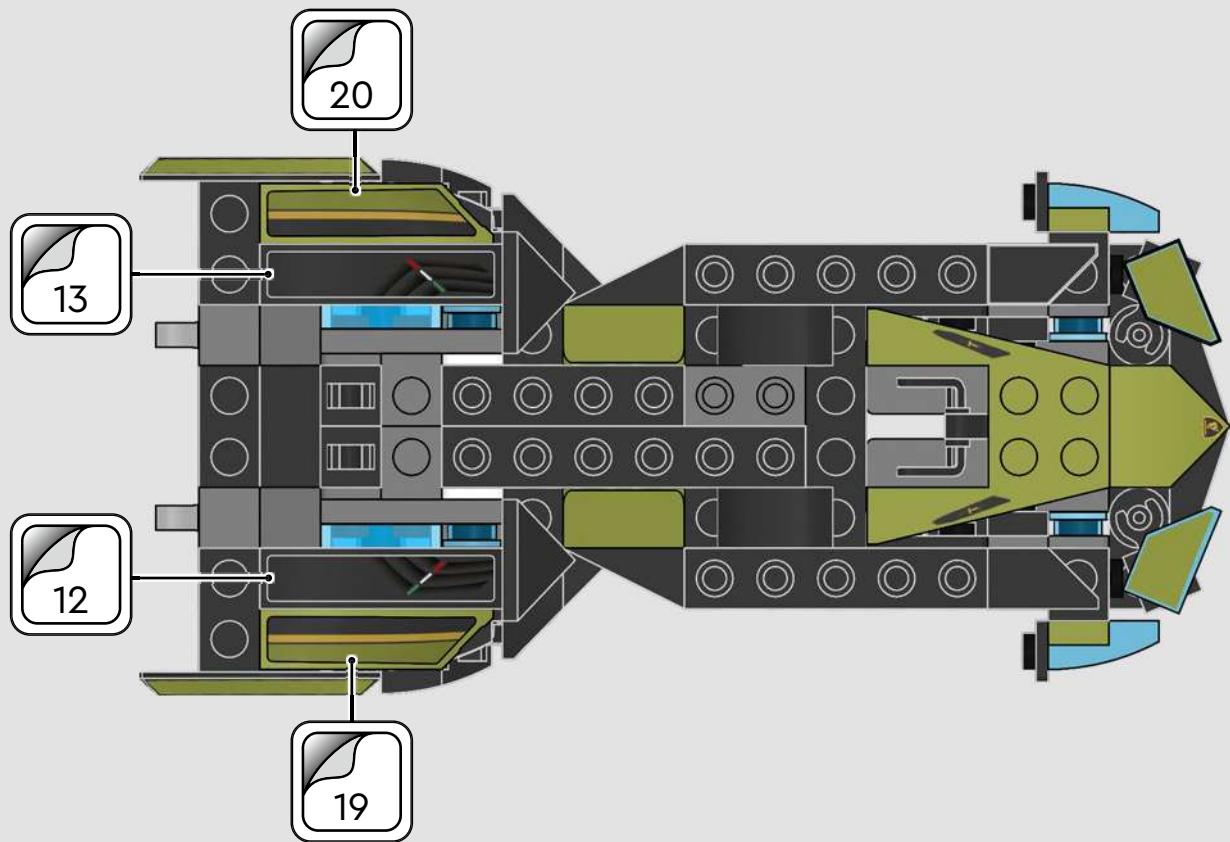

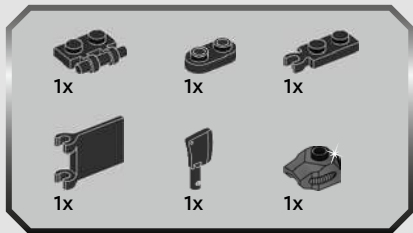

58

1

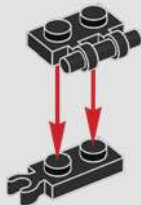

2

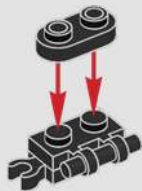

3



4

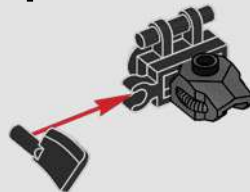

5



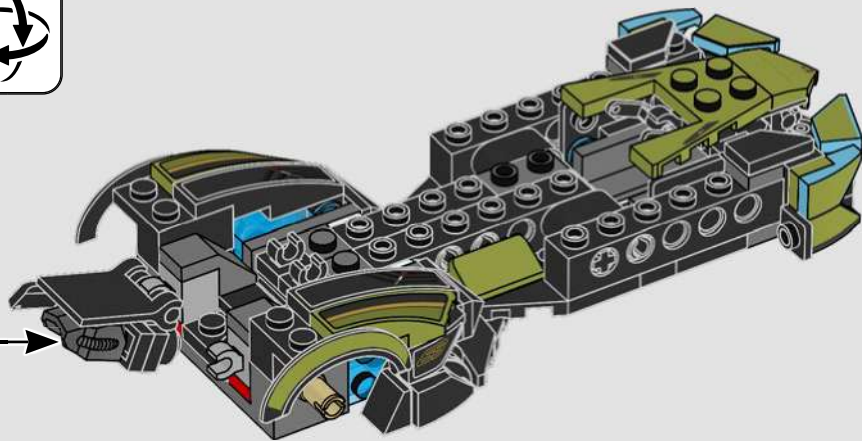
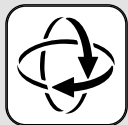

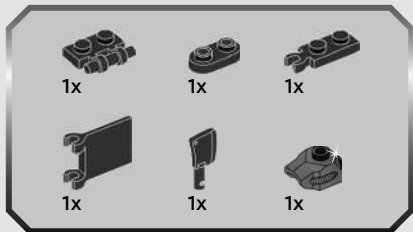

59

1



2

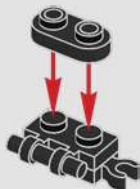

3



4

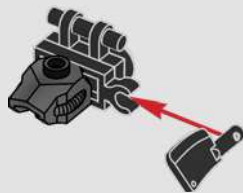

5



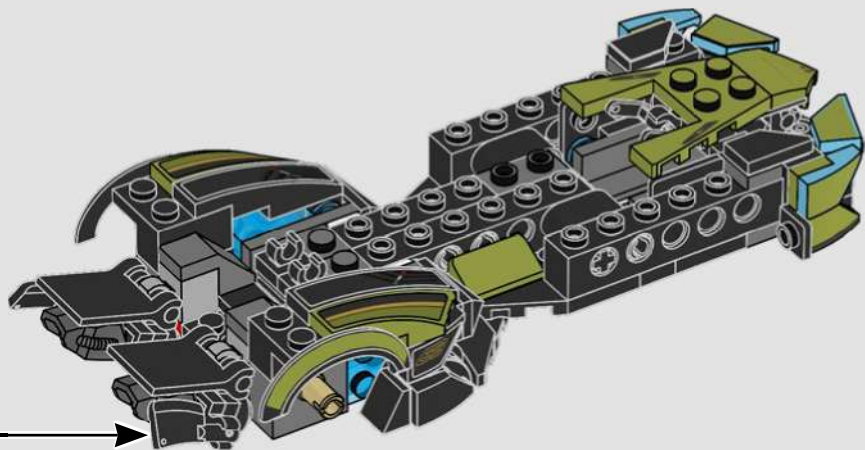



60

1



2

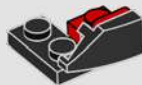

3



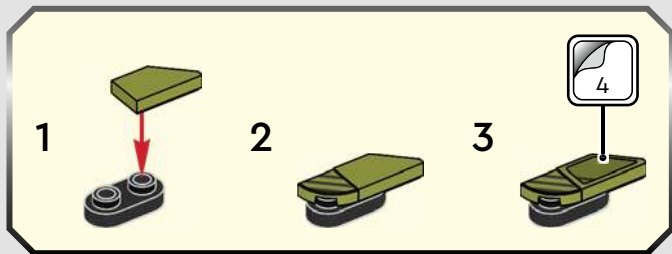

4

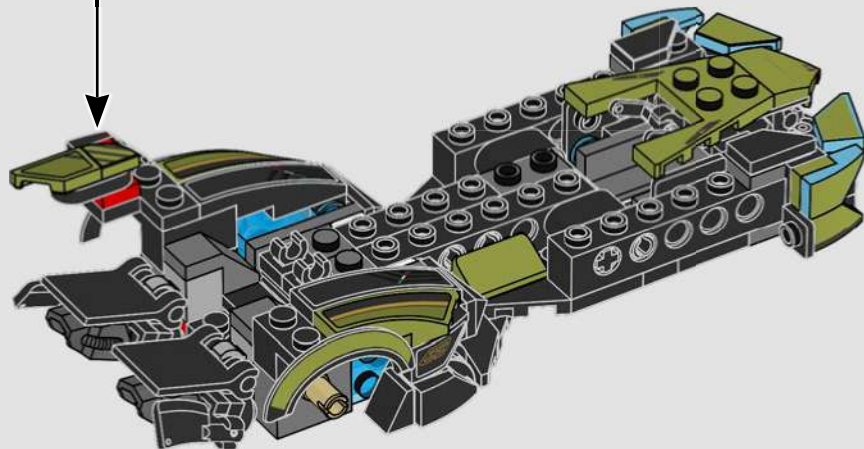
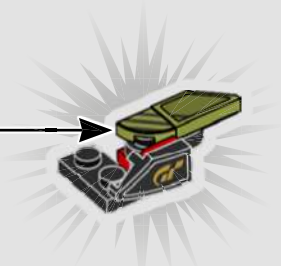



61

1



2



3



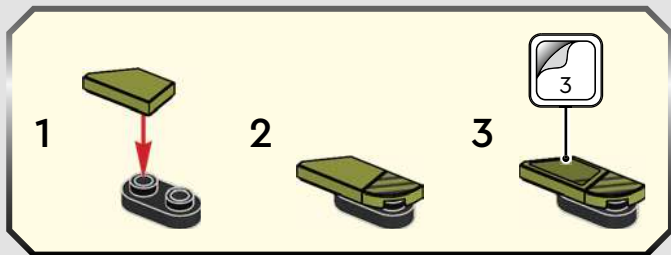

4

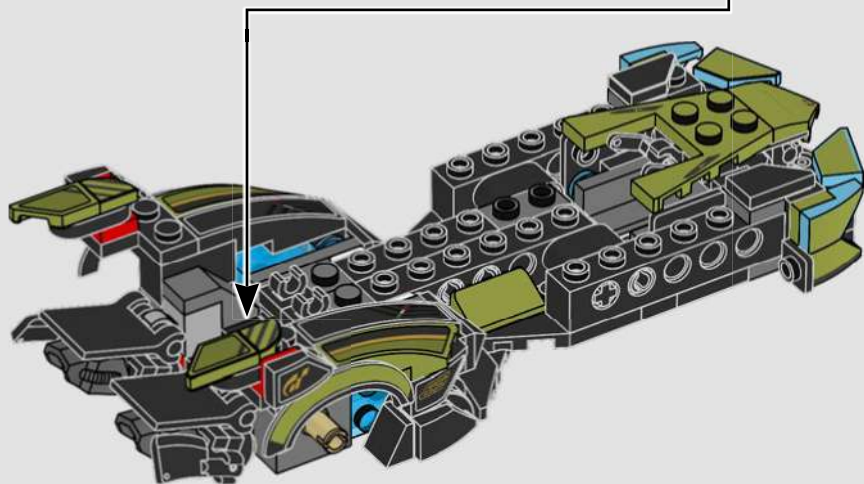
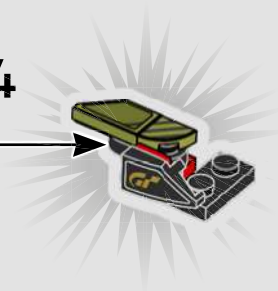



2x

62

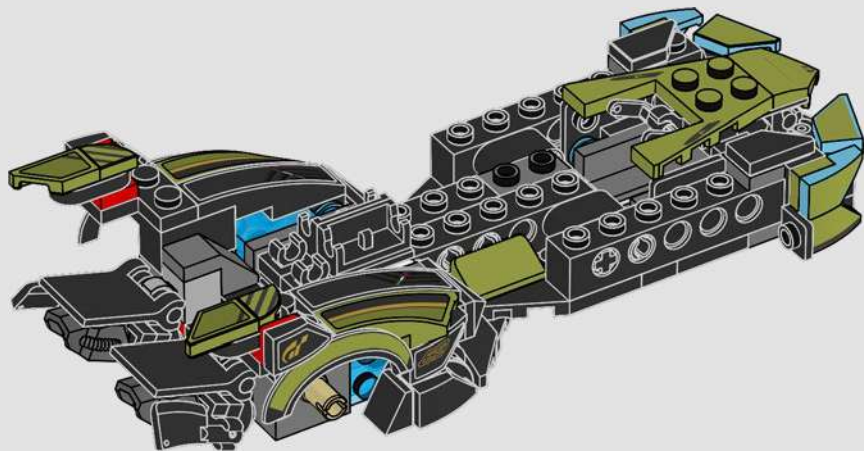

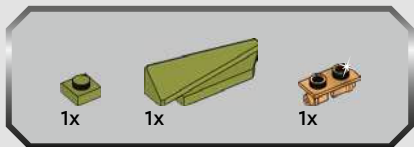

63

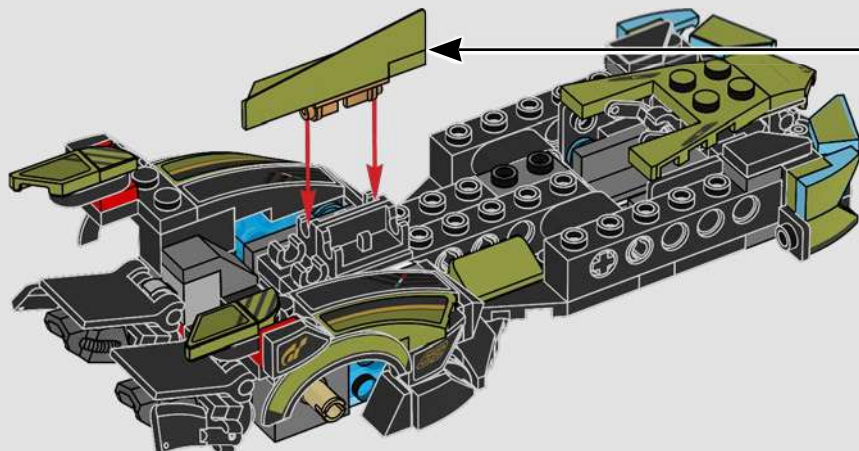
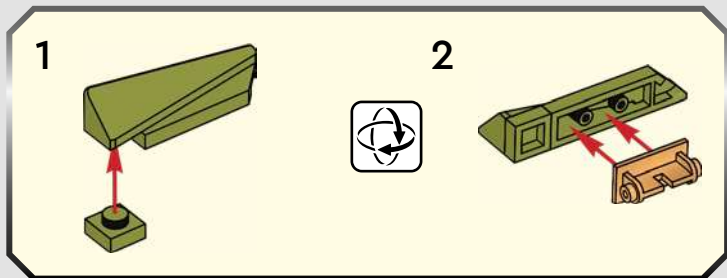

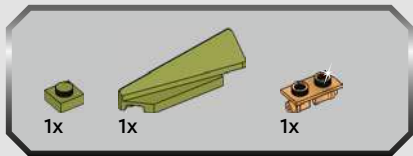

64

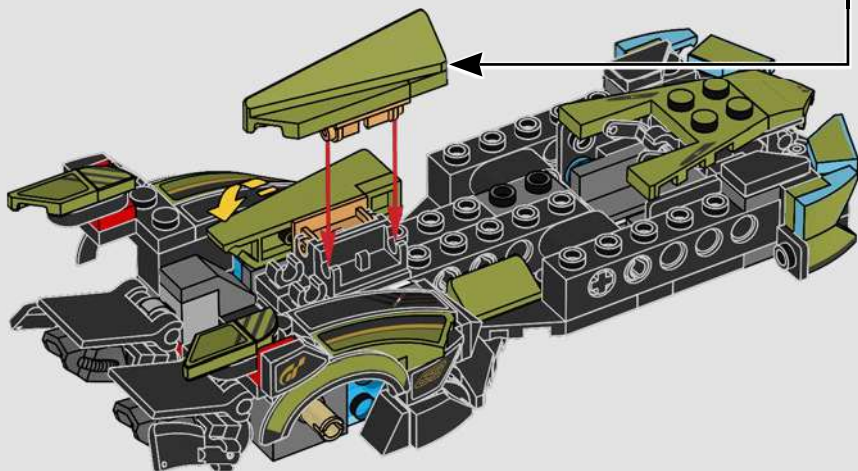
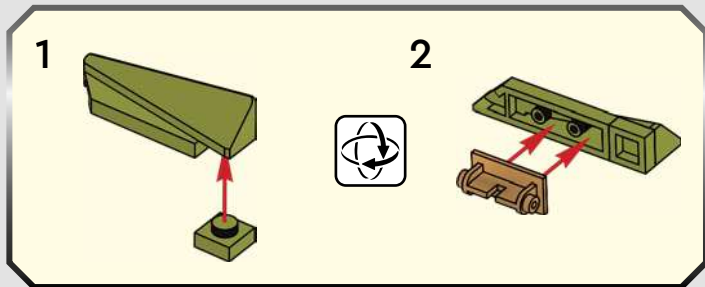



65

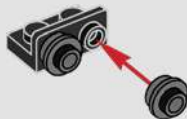

66

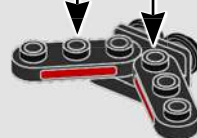
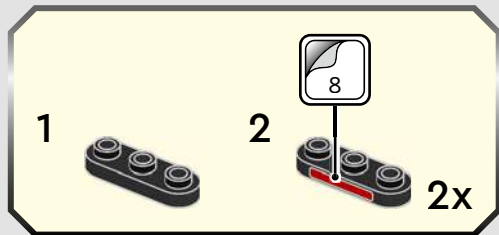

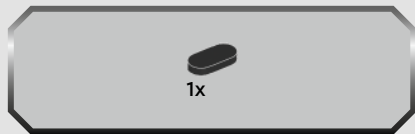

67

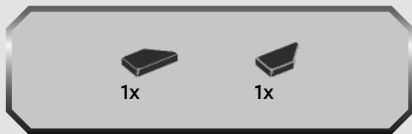

68





69

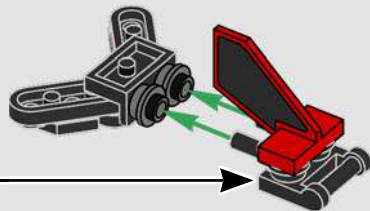
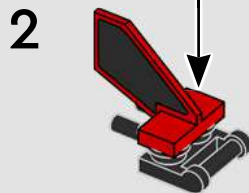
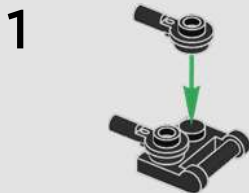
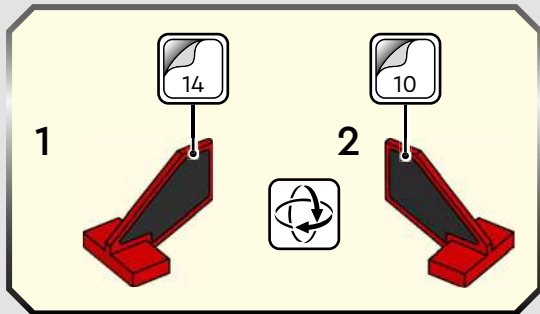

70

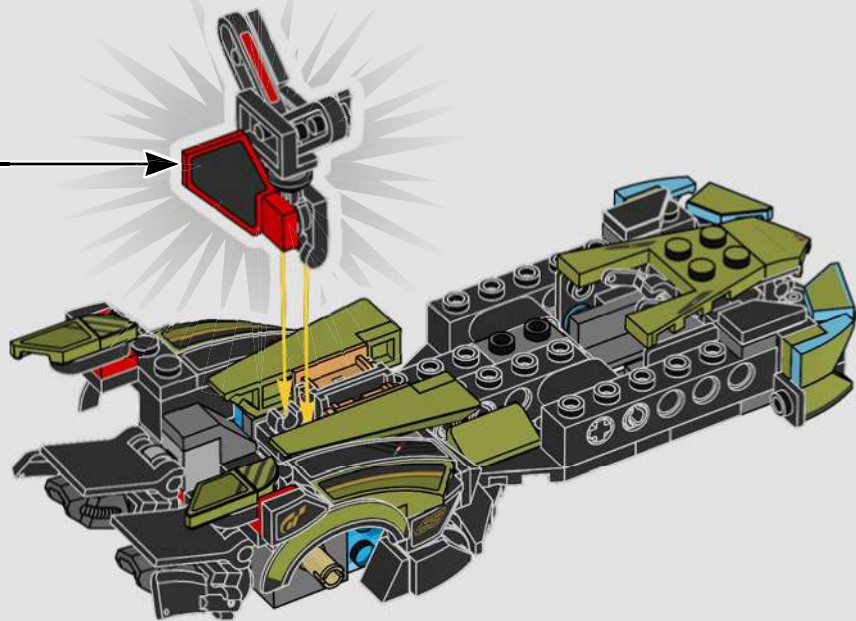

71

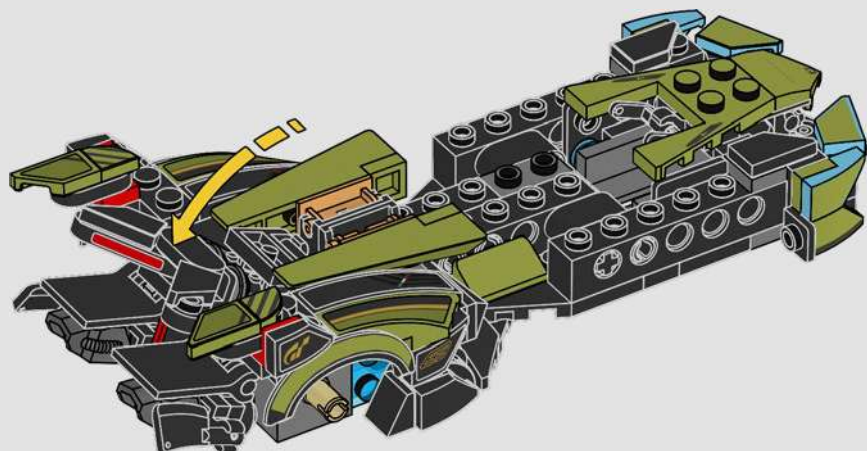

72

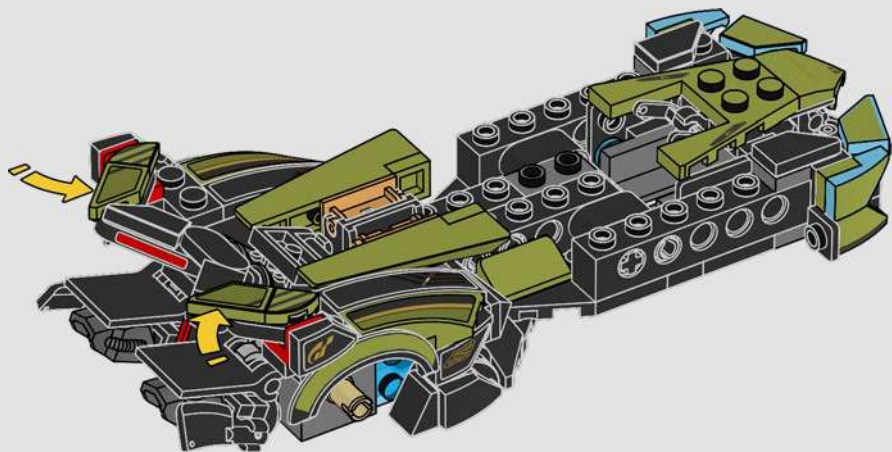



73

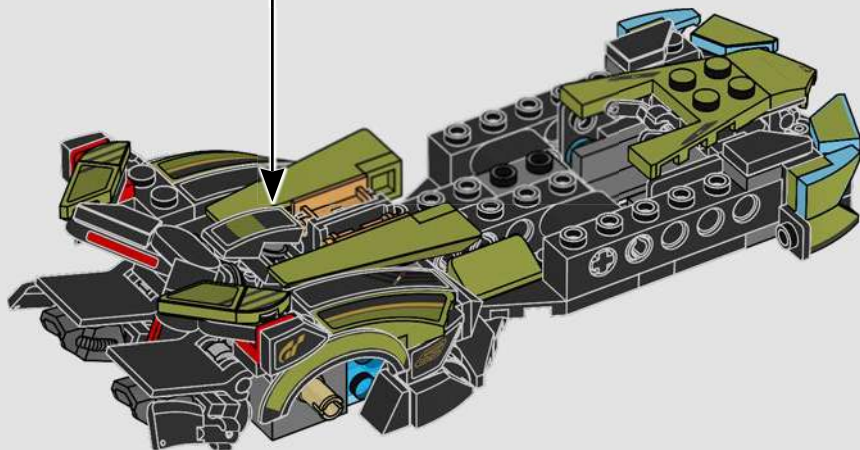
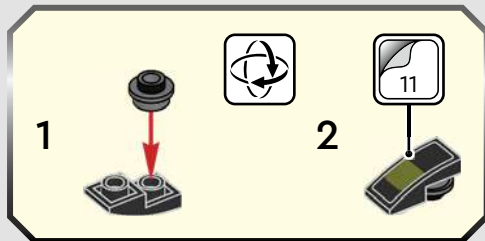



74

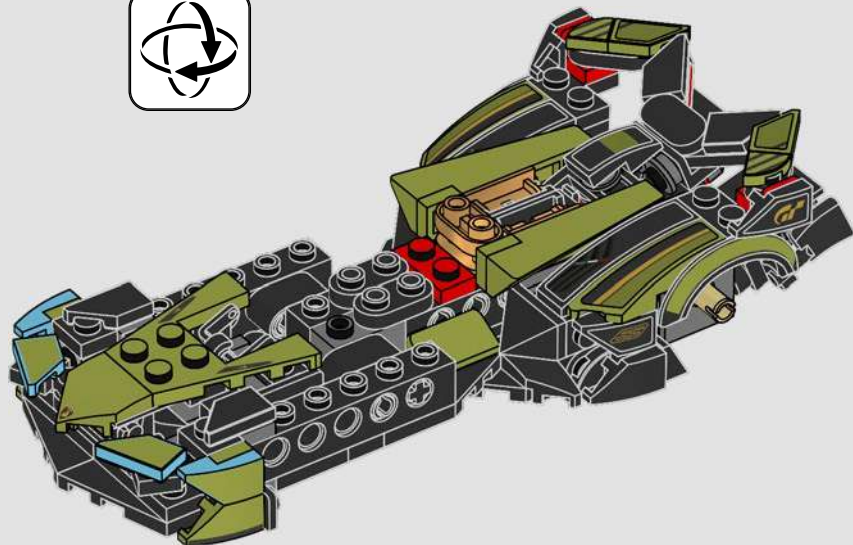



75

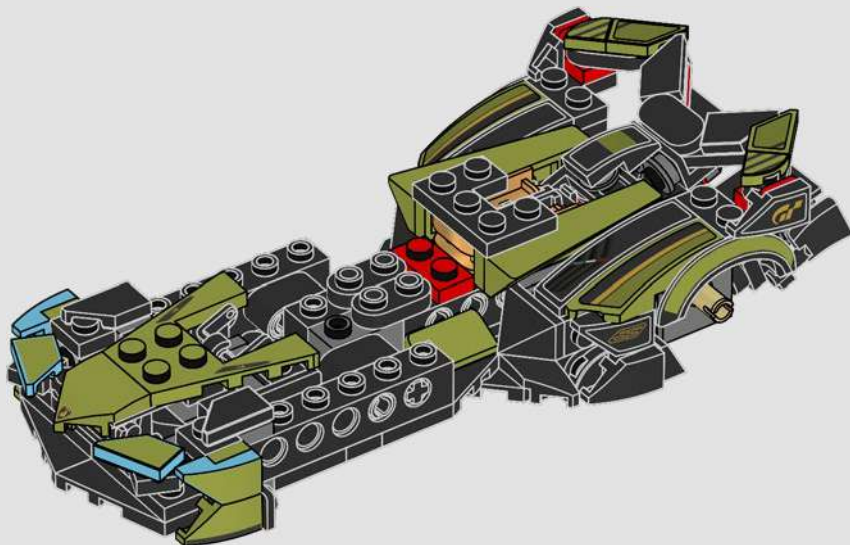

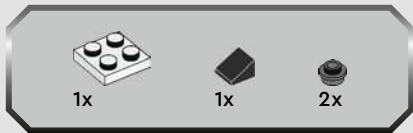

76

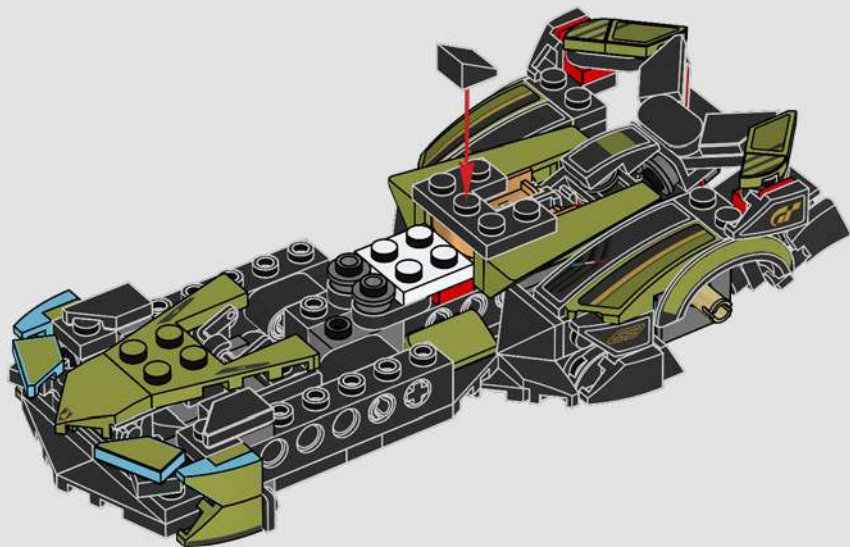

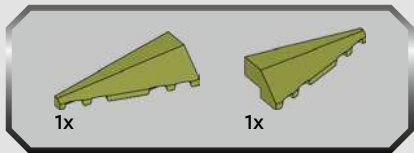

77

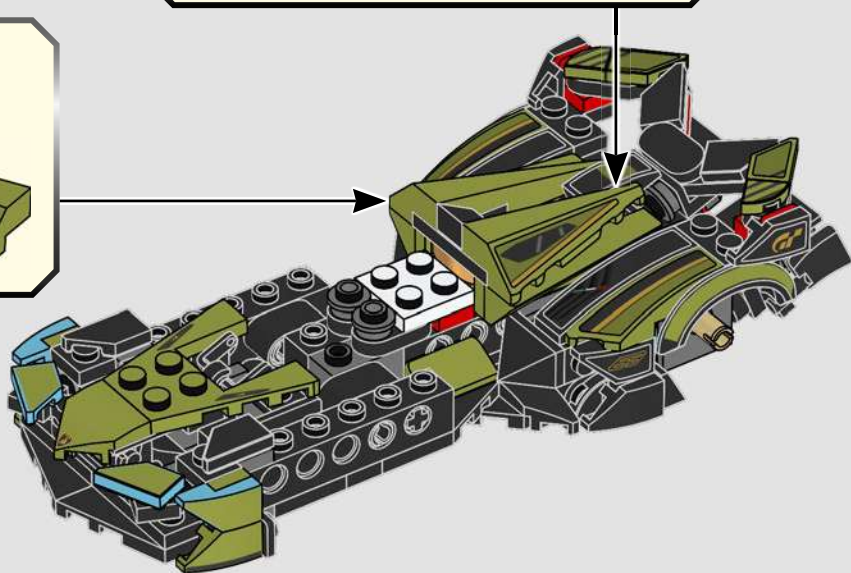
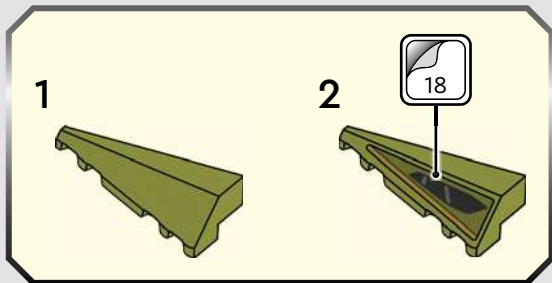
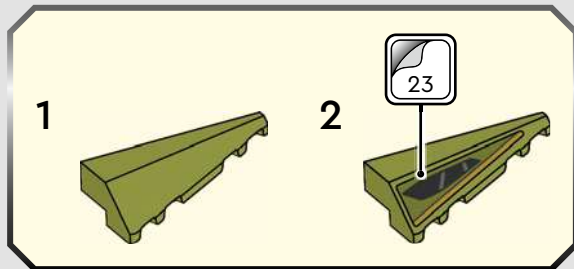



2x

78

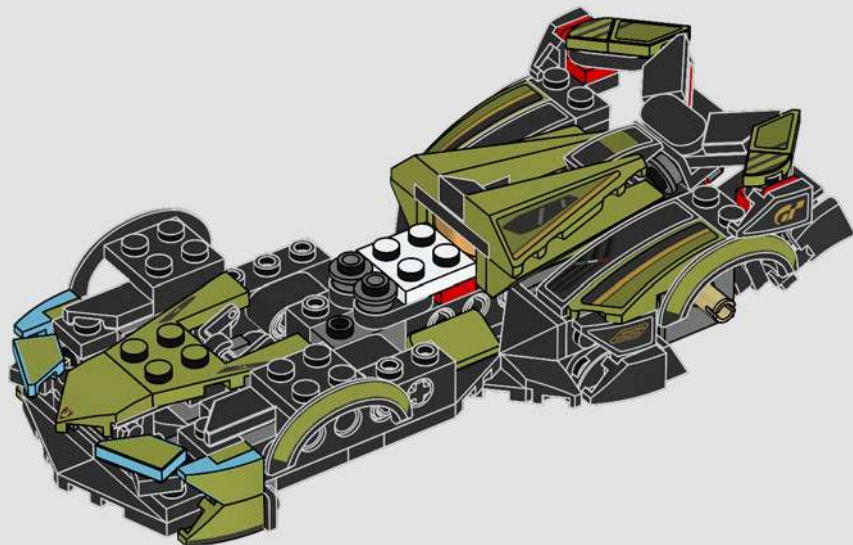



79

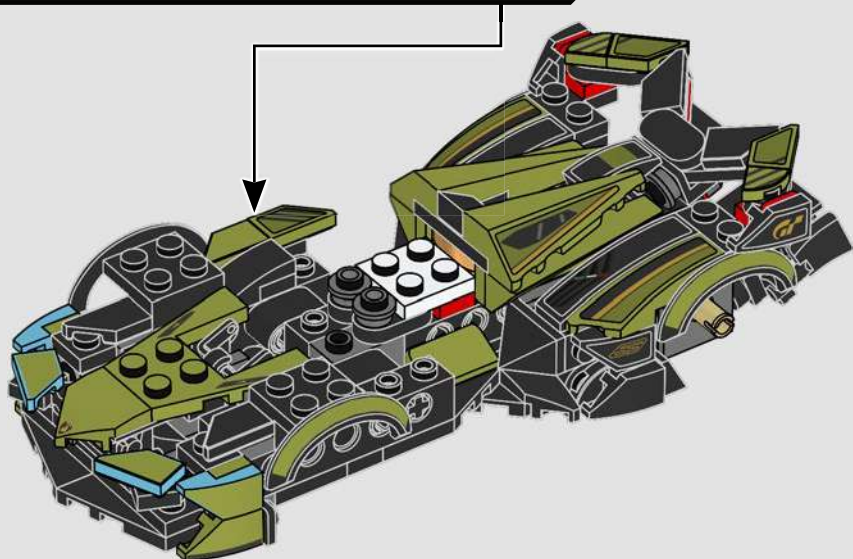
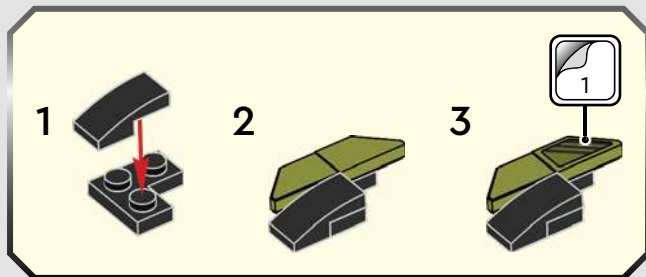



80

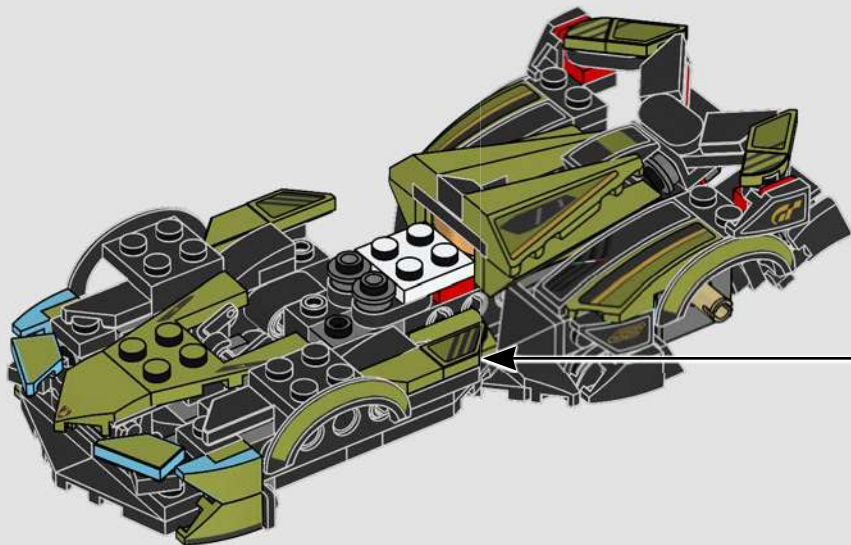
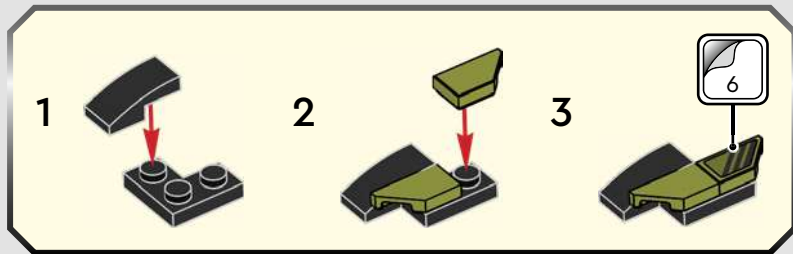



81

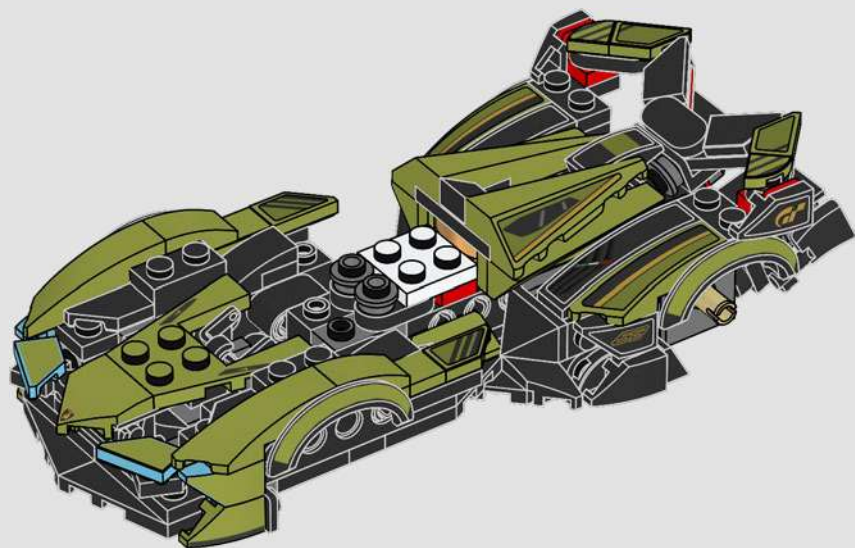

82

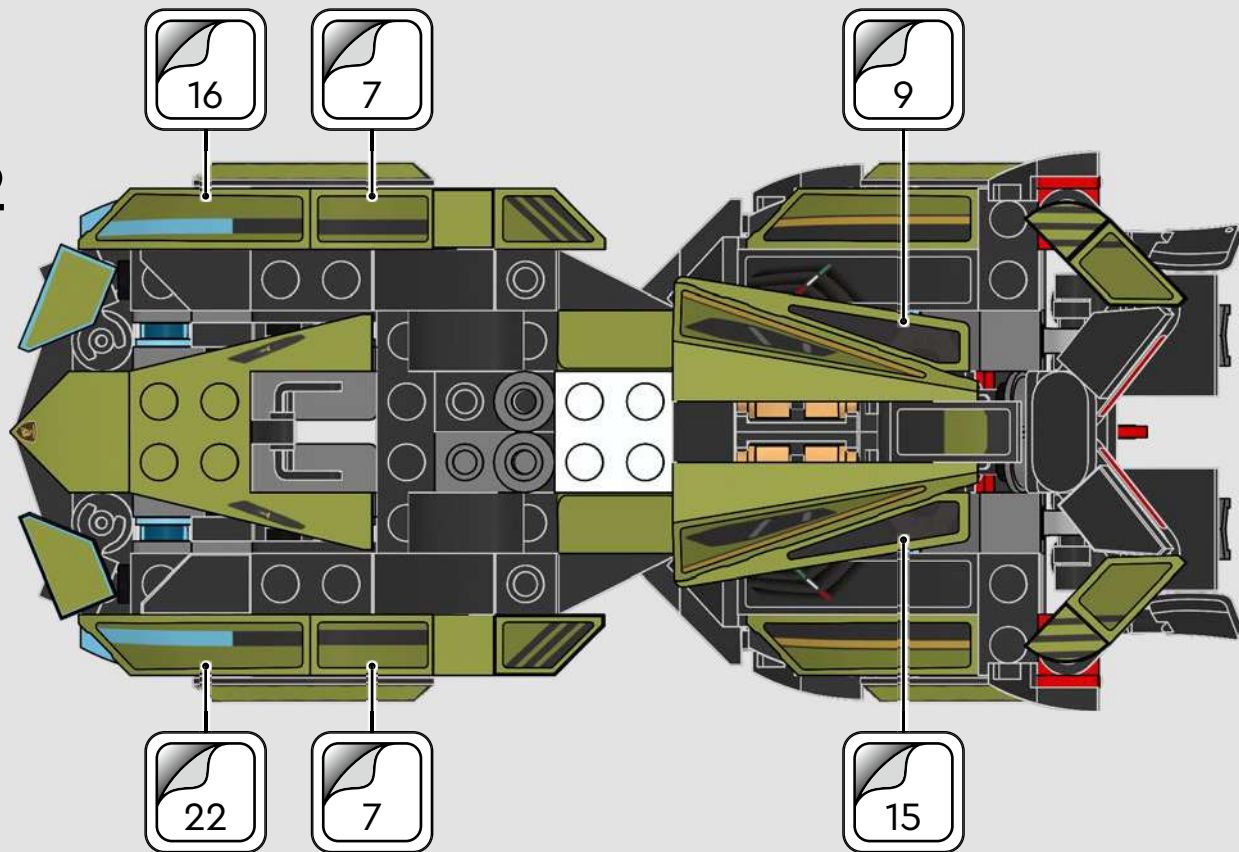



2x



1x

83

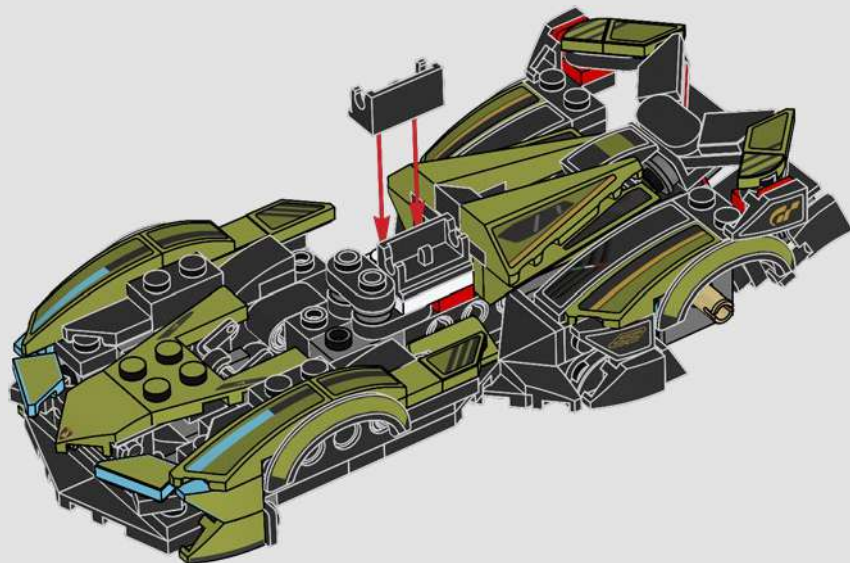

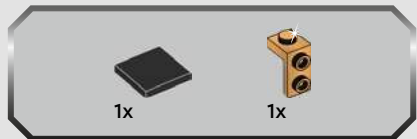

84

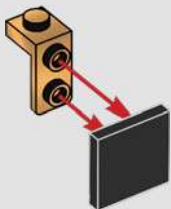

85



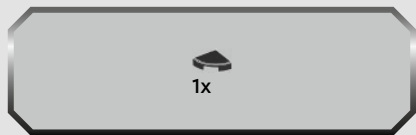

86

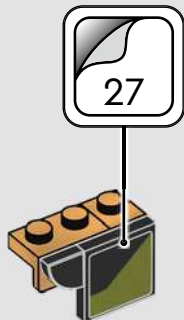

87





88



89



90

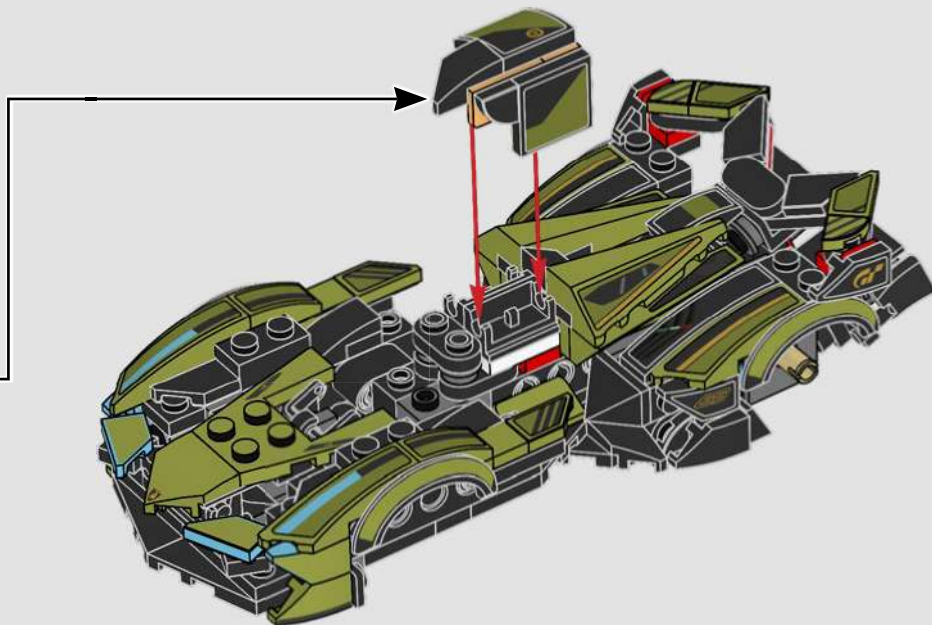

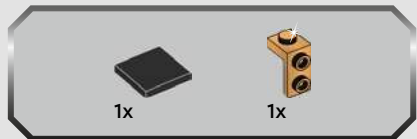

91

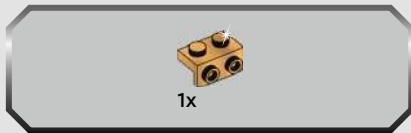
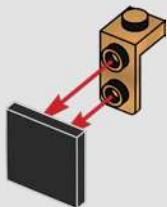

92





93



94





1x

95



1x

96



25



97

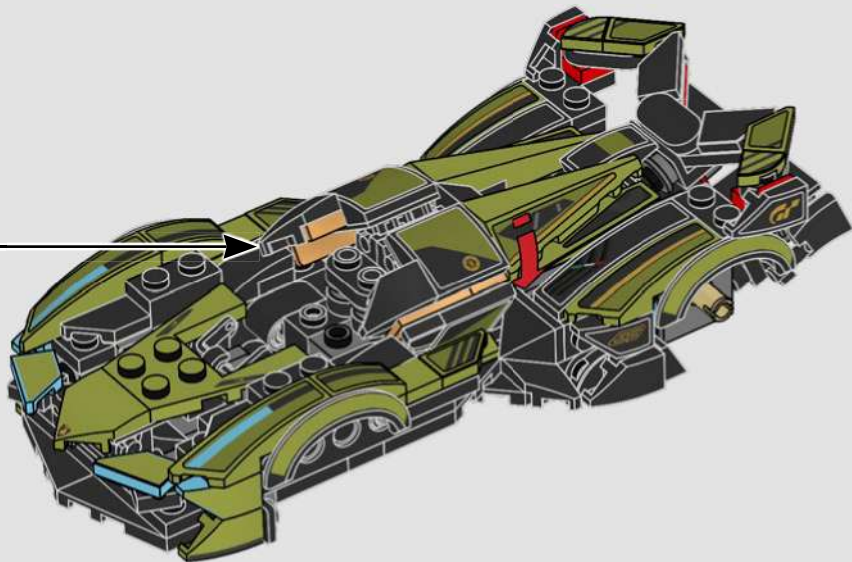



98

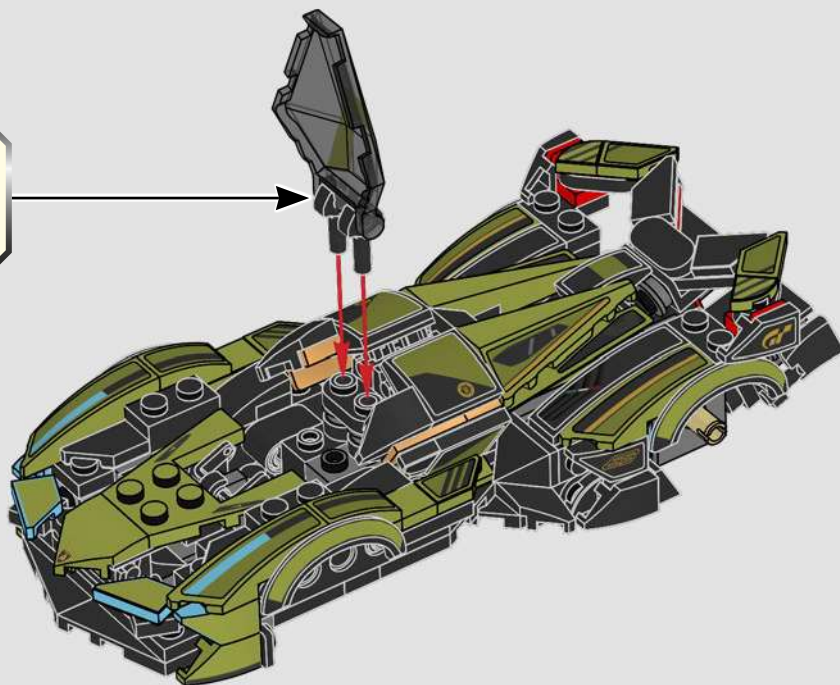
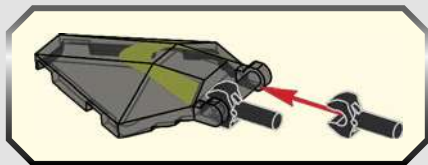



99

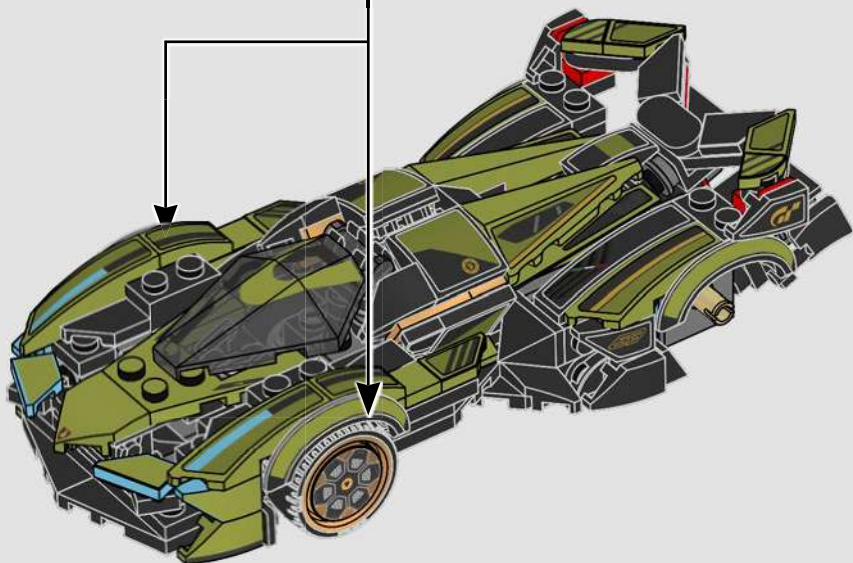
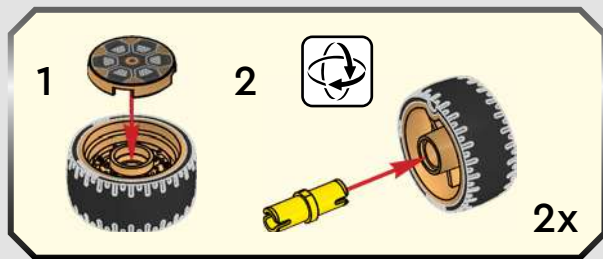



100

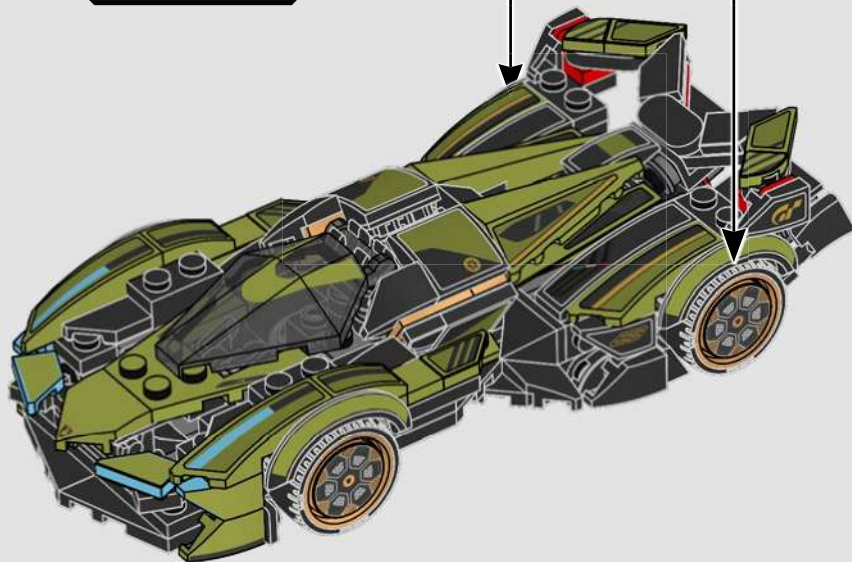

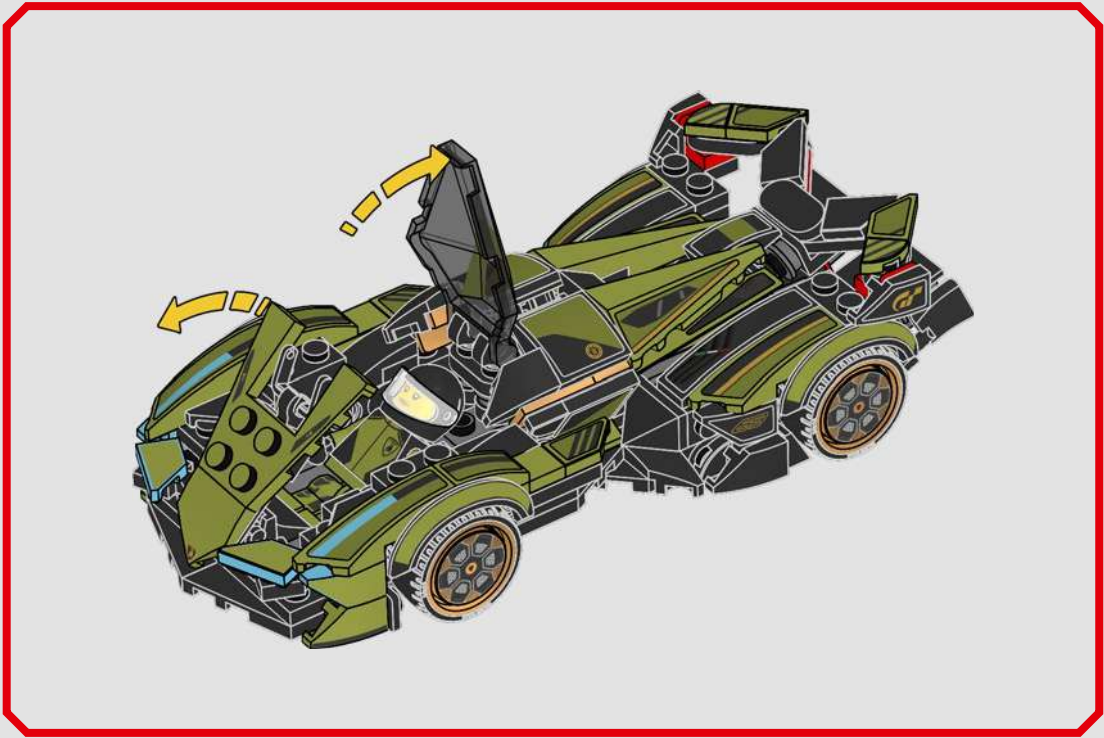

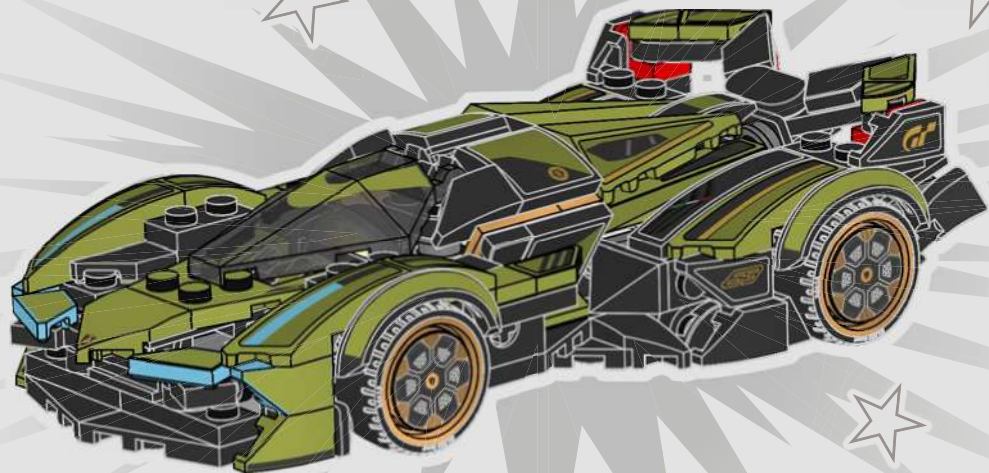



SPEED CHAMPIONS

76923



76924

AMG



The "Lamborghini" and "Lamborghini Bull and Shield" trademarks, copyrights, designs and models are used under license from Automobili Lamborghini S.p.A, Italy.

//////AMG, „Mercedes-Benz" and "Three-pointed star in a ring" are the intellectual property of Mercedes-Benz Group AG. They are used by The LEGO Group under license.



2x
6337079



1x
302201



2x
4666579



2x
6249907



3x
302321



1x
6493693



1x
6303499



2x
6331822



2x
6186675



2x
6395769

86



2x
6439039



2x
6424674



5x
6181720



4x
6172383



3x
4504382



2x
4558954



2x
6335388



2x
6380236



2x
6234695



1x
6245281



2x
6510139



1x
4298619



1x
6507792



9x
6210270



2x
6196548



5x
6181713



1x
4180508



1x
4180536



2x
6330189



1x
4548180



2x
6051508



5x
6279875



2x
6510125



2x
6265091



5x
393726



2x
6047276



1x
6313116



1x
6147050



2x
6000650



1x
6020193



2x
6363034



2x
4140588



2x
6428168



1x
4225201



2x
6350725



1x
6325254



6x
242026



3x
4124096



2x
6053077



2x
306826



1x
6507221



3x
6493691



4x
6504865



1x
6254045



1x
370126



2x
6037746



1x
370626



3x
389426



1x
241926

6



1x
366626



1x
379526

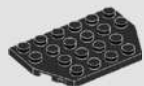

1x
4129572



1x
6244787



10x
6240214



2x
6171732



2x
6238043



2x
6448793



2x
6320306



5x
6231765



2x
4211098



4x
6413106



1x
6178919



2x
6168776



4x
6000606



2x
4211043



2x
6092649



1x
6454959



1x
6288690



2x
6493686



1x
6370621



4x
6472269



2x
6493687



4x
6503580



2x
6495153



1x
6167576



2x
6168708



1x
6504777



1x
6510954



1x
6472273



1x
6510760



2x
6504781



1x
6472272



4x
6058245



3x
6493683



1x
6504778



2x
6016468



3x
6493682



1x
6472267



2x
6031787



1x
6472270



2x
6493675



2x
6493676



1x
6493680



1x
6493678



1x
6493679



1x
6504780



1x
6493677

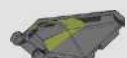

1x
6504779



LEGO.com/service



YOU COULD
WIN

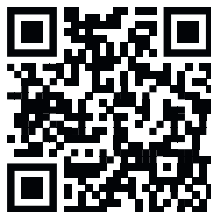

Scan this QR code or go to
LEGO.COM/PRODUCTFEEDBACK and give us
your short feedback about this LEGO® set for
a chance to win a cool LEGO prize.

Terms and Conditions apply*

EN: YOU COULD WIN. Terms and Conditions apply* **DE: Du könntest GEWINNEN.** Es gelten die Teilnahmebedingungen* **FR: Tu pourrais GAGNER.** Des conditions s'appliquent* **IT: Potresti VINCERE tu.** Termini e condizioni sono applicabili* **ES: Puedes GANAR.** Aplican términos y condiciones* **PT: Poderá GANHAR.** Aplicam-se termos e condições* **ZH: 轻松获奖. 条款和条件适用*** **PL: Szansa na WYGRANĄ.** Obowiązują warunki korzystania* **CS: Máte šanci VYHRÁT.** Platí všeobecné smluvní podmínky* **SK: Máte šancu VYHRÁŤ.** Platia všeobecné zmluvné podmienky* **HU: TE IS NYERHETSZ.** Felhasználási feltételek érvényesek* **RO: Ai putea CÂȘTIGA.** Se aplică termenii și condiții* **BG: Можете да СПЕЧЕЛИТЕ.** Има определени правила и условия* **LV: Tu vari LAIMĒT.** Ir spēka noteikumi un nosacījumi.* **ET: Sul on võimalus VÕITA.** Kehtivad tingimused* **LT: Jūs galite LAIMĖTI.** Taikomos sąlygos*

*[LEGO.com/productfeedback/terms](https://www.lego.com/productfeedback/terms)

LEGO and the LEGO logo are trademarks of the/son des marques de commerce du/son marcas registradas de LEGO Group. ©2024 The LEGO Group.

The "Lamborghini" and "Lamborghini Bull and Shield" trademarks, copyrights, designs and models are used under license from Automobili Lamborghini S.p.A, Italy.

Vision GT logo is a registered trademark or trademark of Sony Interactive Entertainment Inc.

6522907