



# NINJAGO LEGACY

30591



6353606

# WIN

GO TO [WWW.LEGO.COM/RB2021](http://WWW.LEGO.COM/RB2021) TO FILL OUT A SHORT SURVEY ON THIS PRODUCT FOR A CHANCE TO WIN A COOL LEGO SET.

Terms & Conditions apply

## LEGO.com/RB2021



### GAGNE

Rendez-vous au [www.LEGO.com/RB2021](http://www.LEGO.com/RB2021) pour remplir un court questionnaire sur ce produit et courir la chance de gagner un fantastique ensemble LEGO®. Voir Conditions Générales

### GANA

Visita [www.LEGO.com/RB2021](http://www.LEGO.com/RB2021) y responde una breve encuesta sobre este producto. ¡Puedes ganar un fantástico set LEGO®! Términos y Condiciones aplicables

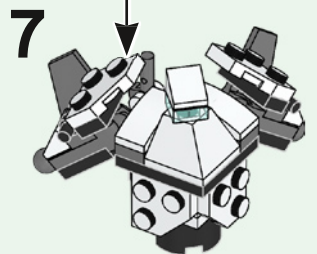
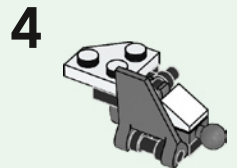
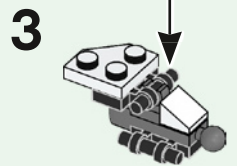
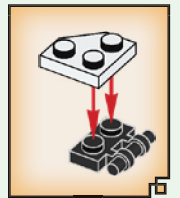
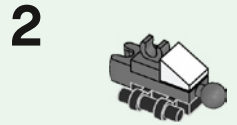
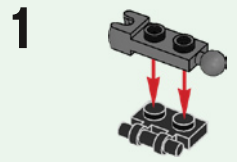
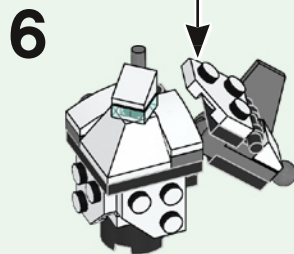
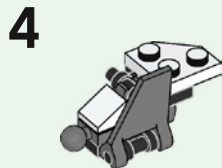
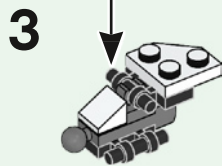
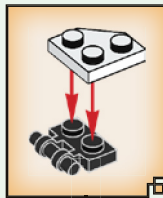
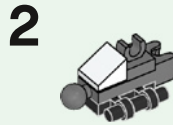
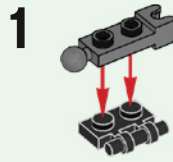
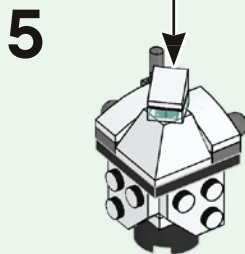
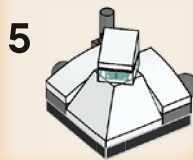
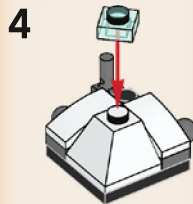
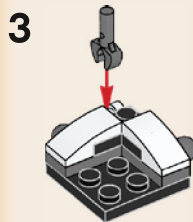
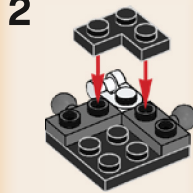
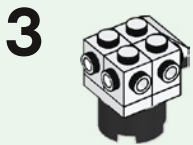
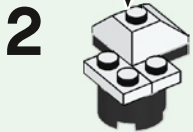
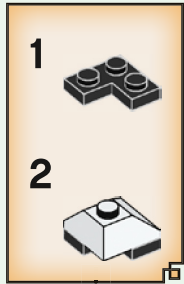
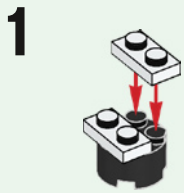

1

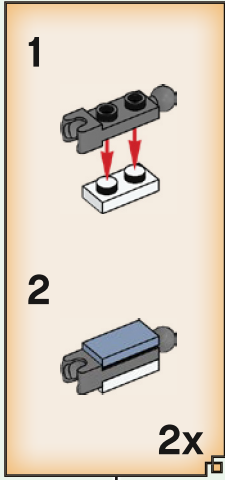

2

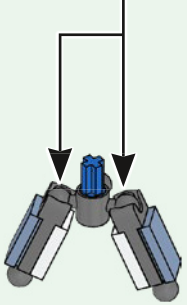

8

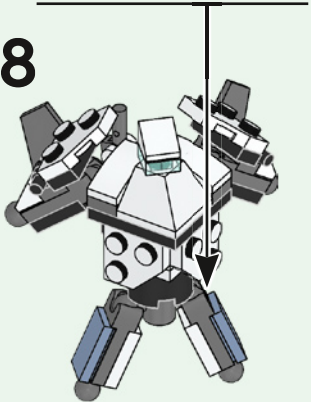

1

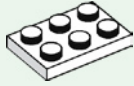

2



3

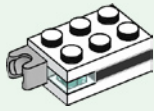

4

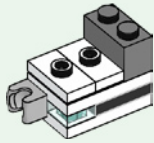

5

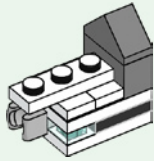

6

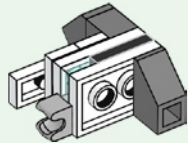

9

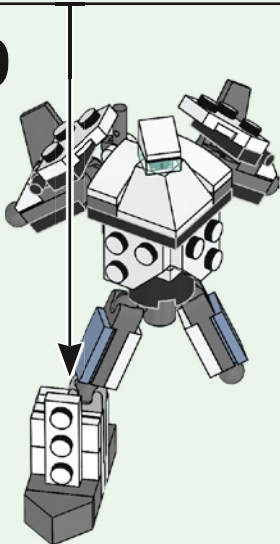

1

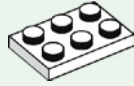

2



3

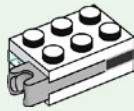

4

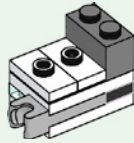

5

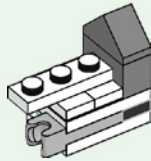

6

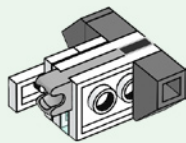

10

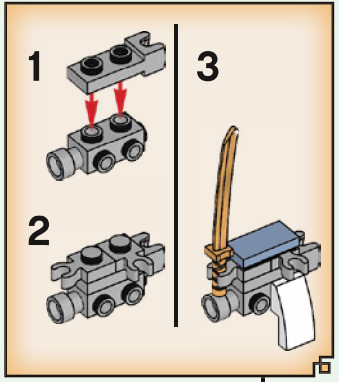
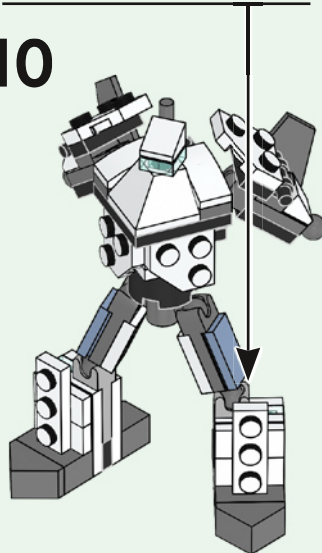

11

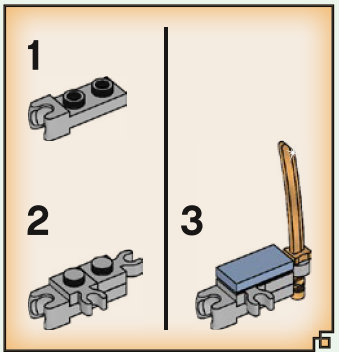
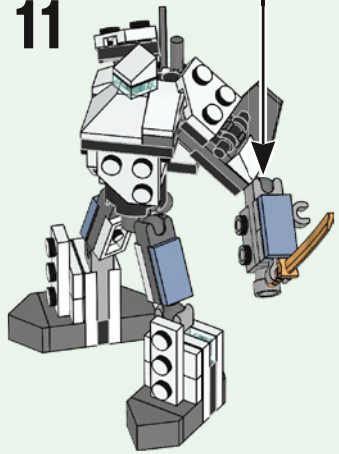

12

