



STAR WARS

75369





Get excited about our new packaging!

We're switching from plastic to paper-based packaging. That's why you might find a mix of paper and plastic in our boxes!

Nos nouveaux emballages vous emballeront !

Nous passons des emballages en plastique aux emballages à base de papier. C'est pourquoi vous pourriez trouver un mélange de papier et de plastique dans nos boîtes !

¡Te presentamos nuestros nuevos empaques!

Estamos sustituyendo las bolsas de plástico por bolsas con base de papel. ¡Por eso, puedes encontrar una mezcla de papel y de plástico en nuestras cajas!

[LEGO.com/sustainable-packaging](https://www.lego.com/sustainable-packaging)



BUILDER



Apple and the Apple logo are trademarks of Apple Inc., registered in the U.S. and other countries and regions. App Store is a service mark of Apple Inc. Google Play and the Google Play logo are trademarks of Google LLC. Tencent and the Tencent logo are trademarks of Tencent Inc.

🔍 LEGO.com/devicecheck

EN Ask parents' permission before going online | **DE** Eltern um Erlaubnis bitten, bevor du online gehst | **FR** Demande l'autorisation d'un parent avant d'aller en ligne | **IT** Chiedi il permesso ai tuoi genitori prima di andare online | **ES** Pídeles permiso a tus papás antes de conectarte a Internet | **PT** Peça autorização aos pais antes de acederes online | **ZH** 上网前应先征得父母的同意 | **PL** Poproś rodziców o zgodę, zanim wejdiesz do Internetu | **CS** Než půjdeš na internet, požádej rodiče o svolení | **SK** Skôr než pôjdeš na internet, vypýtaj si povolenie od rodičov | **HU** Kérj szülői engedélyt, mielőtt online csatlakoznál! | **RO** Cere permisiunea părinților înainte de a te conecta online | **BG** Поискайте разрешение от родител, преди да влезете онлайн | **LV** Pirms došanās tiešsaistē palūdz atļauju vecākiem | **ET** Enne Interneti kasutamist küsi vanematelt luba | **LT** Prieš prisijungdami prie interneto, atsiklauskite tėvų



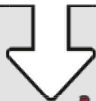
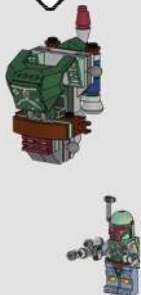
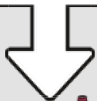



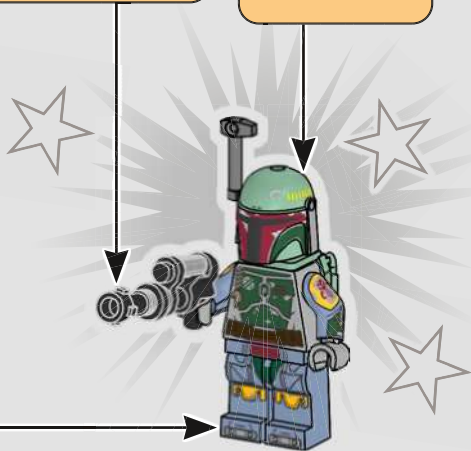
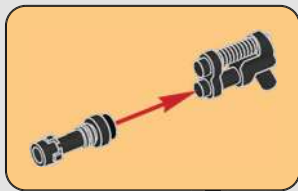
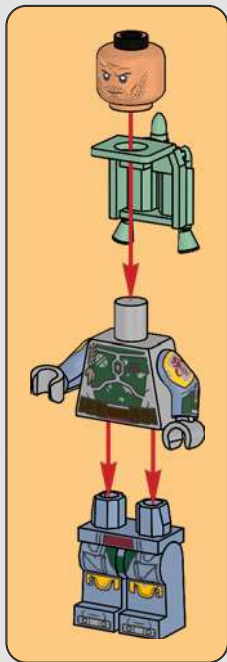

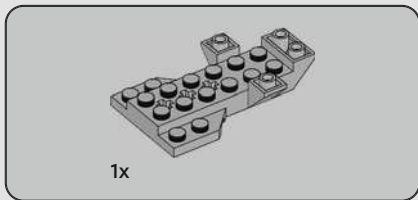

1

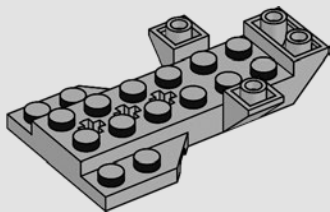



1x

2

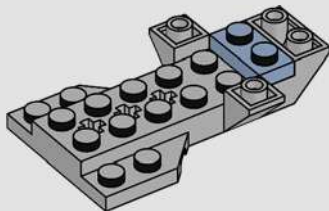



1x

3

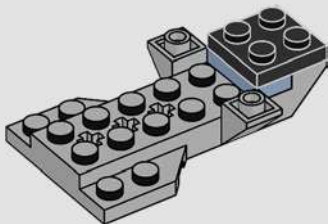

2x

4

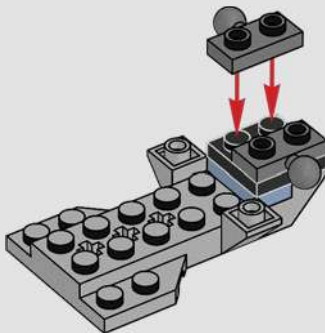



1x

5

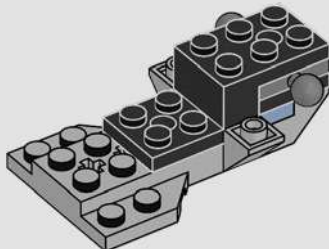

10





1x

6

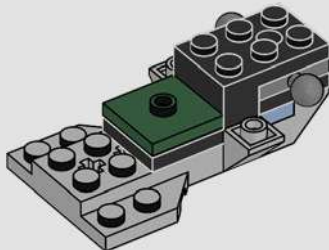

2x

7

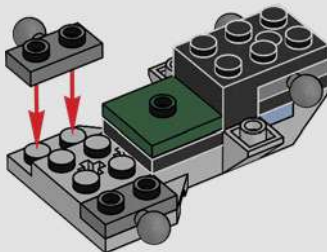



2x

8

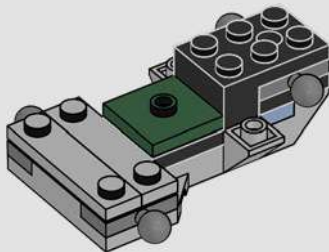



2x

9

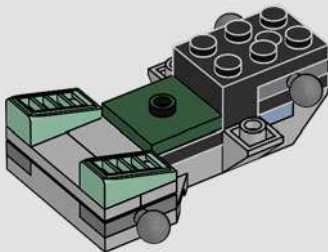

2x

10

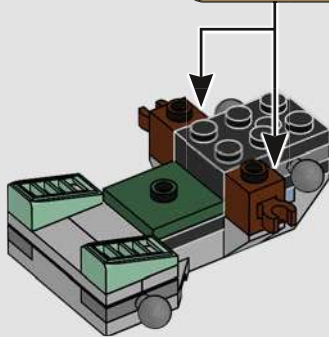



2x

11

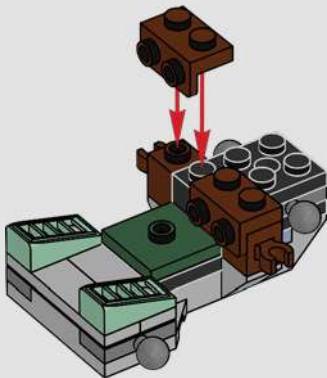



1x

12

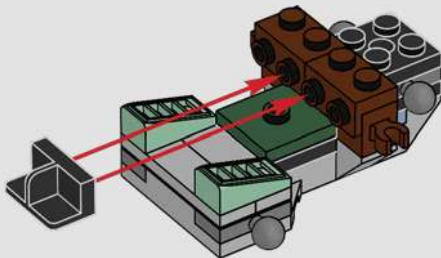

2x

13

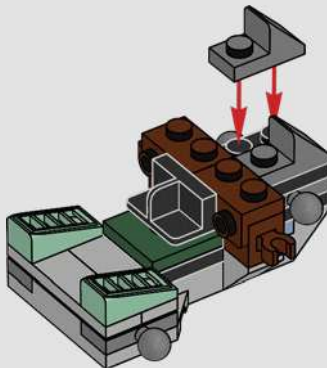



2x

14

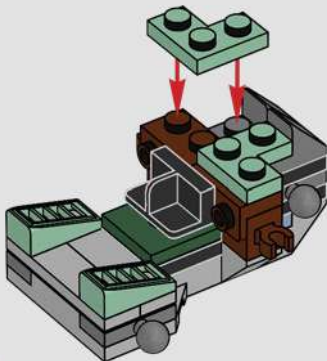



2x

15

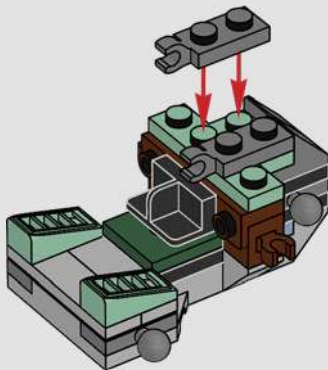

1x



1x

16

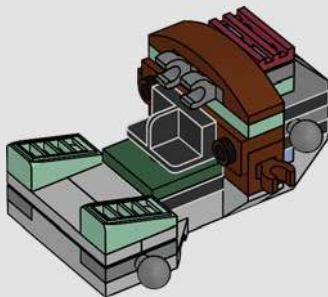

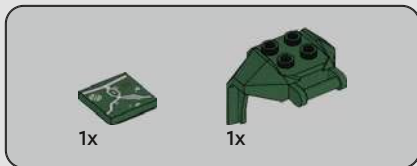

17

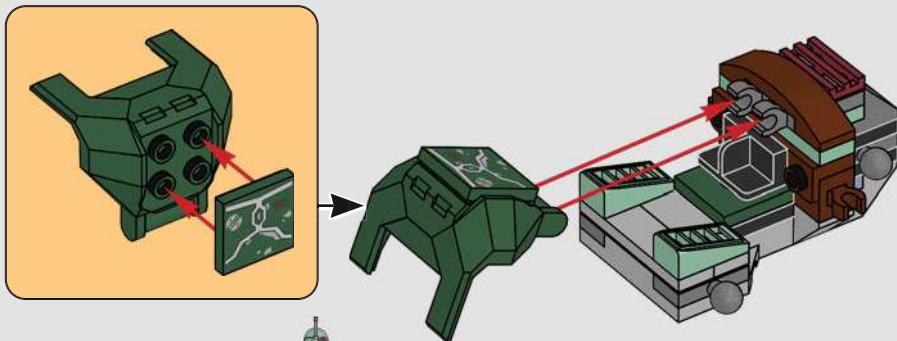

18





1x



1x

18

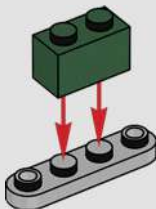



1x



1x

19

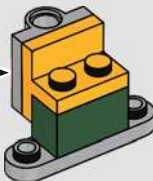
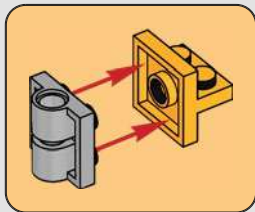



1x

20



1x

21





4x

22

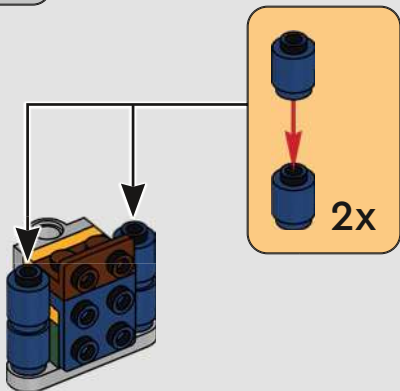



1x

23



2x

24





2x

25



24



26

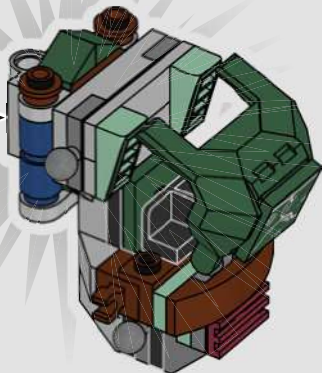





1x



1x

27

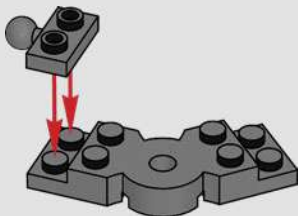



1x

28

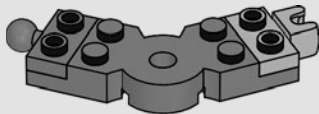

28





1x

29

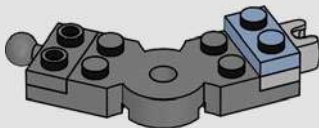



30

1

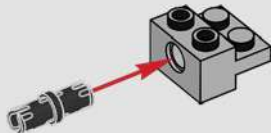

2

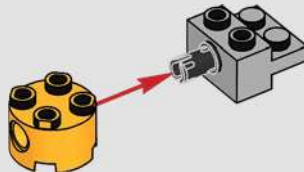





1x



1x

31

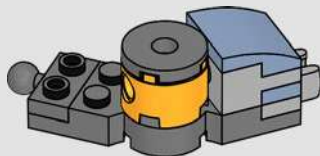

32





1x

32





1x

33



34



34

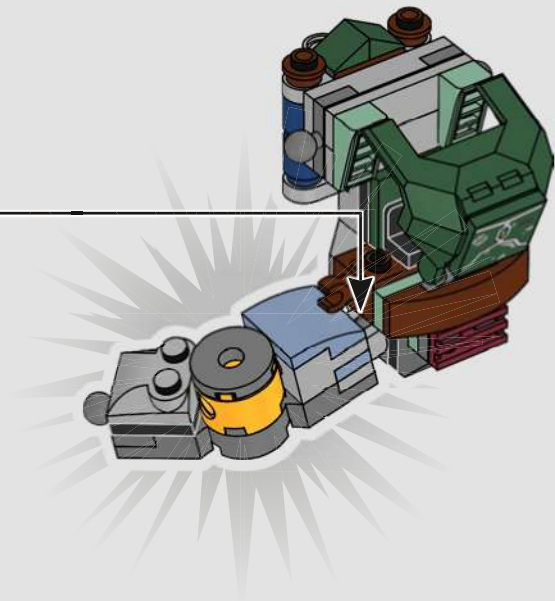



1x



1x

35

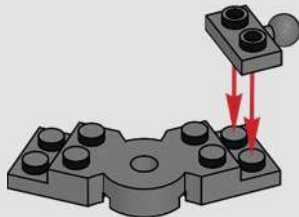



1x

36

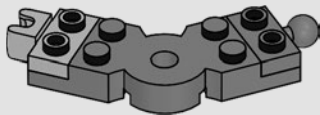

1x

37

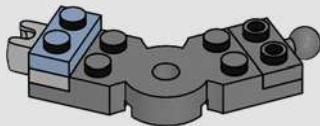



38

1

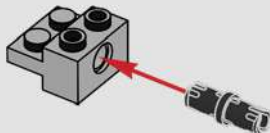

2

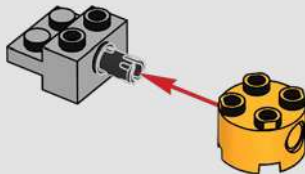

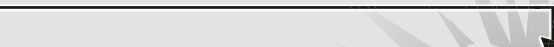



1x



1x

39

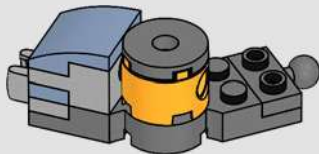



1x

40





1x

41



42





42

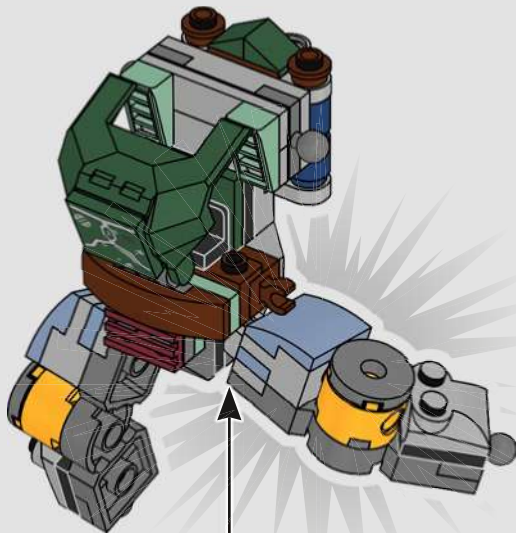



1x



1x

43





1x

44

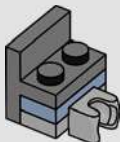

1x

45

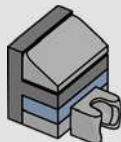

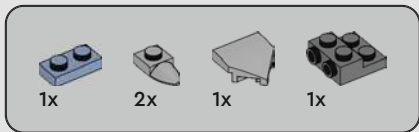

46

1



2

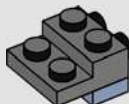

3

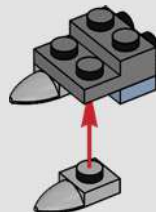

4

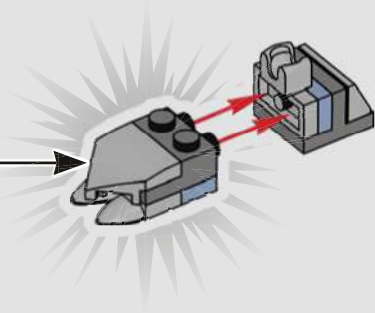
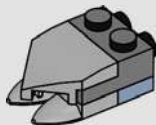



1x

47

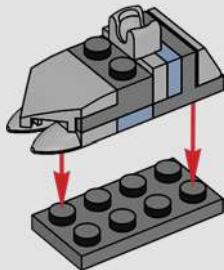

2x

48

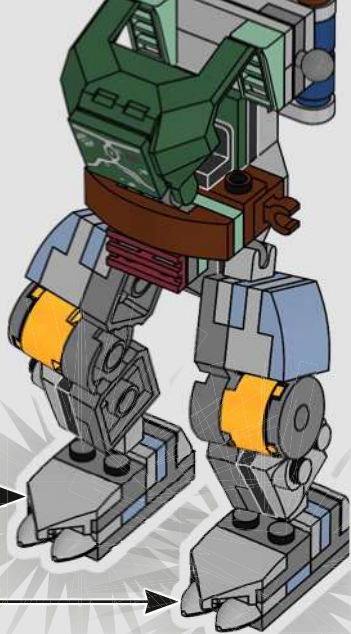





49

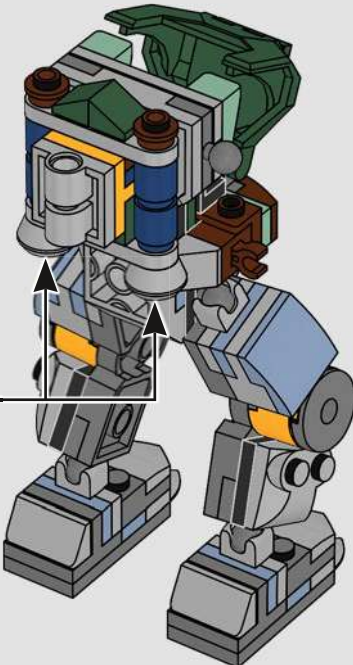

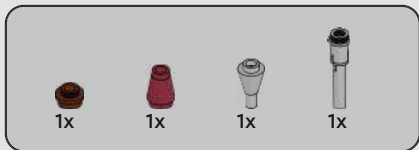

50

1



2



3



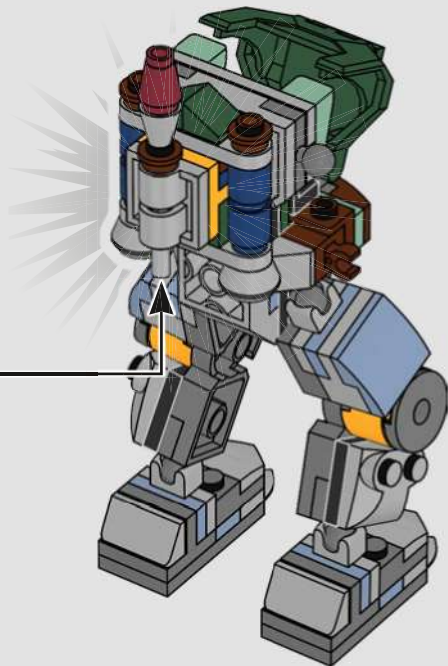

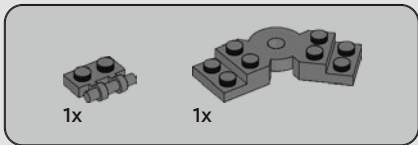

51

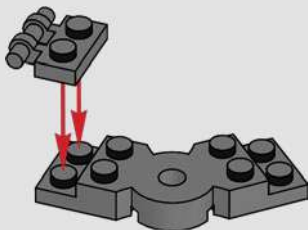



1x

52

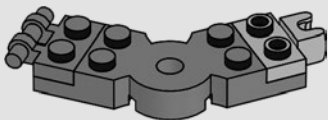

1x

53

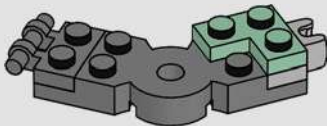



1x

54

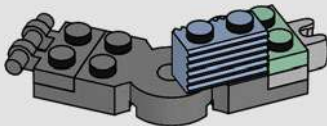



1x

55



1x



1x

56

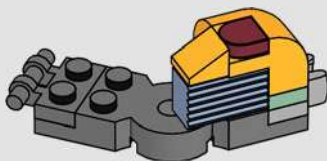



1x



1x

57

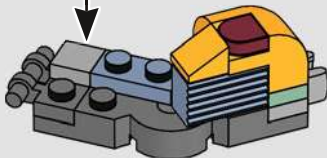
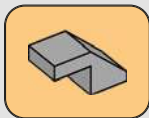



1x

58



1x



1x

59

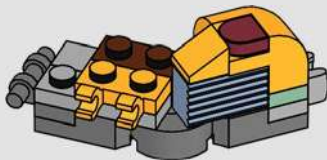



1x



1x

60

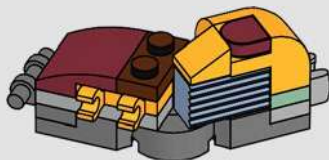



1x

61

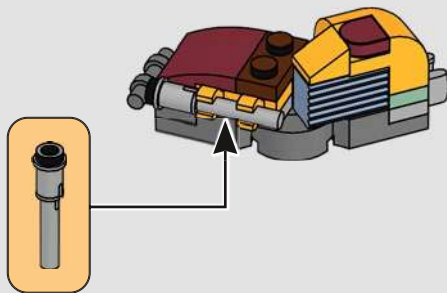



3x

62

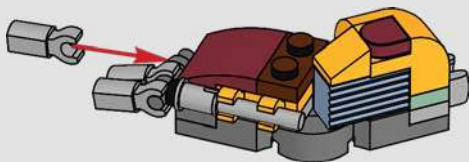

63

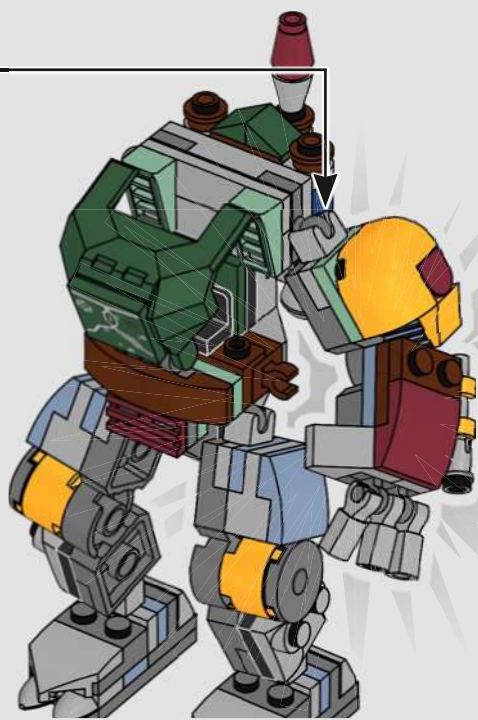

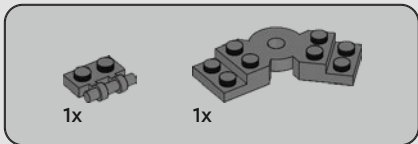

64

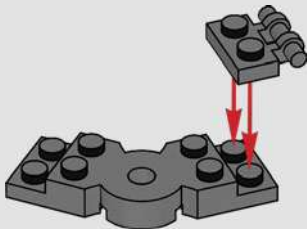



1x

65



1x

66

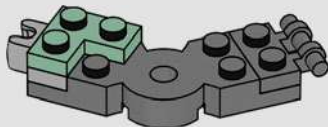



1x

67

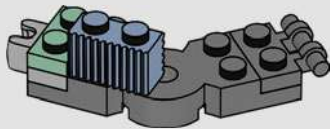



1x

68

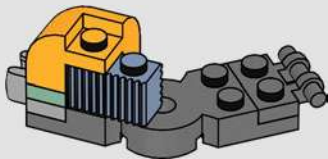

1x

69

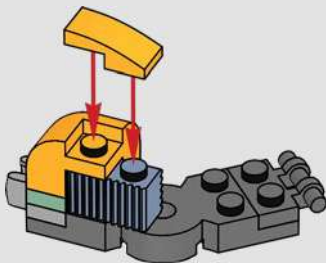



1x



1x

70

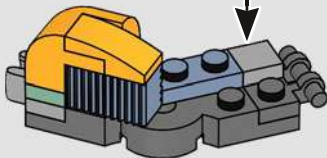
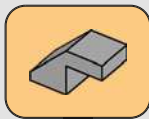



1x

71

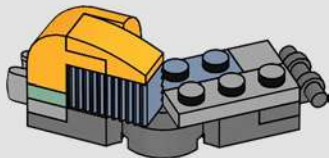

1x



1x

72

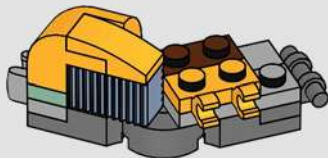



1x



1x

73

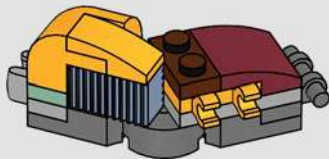

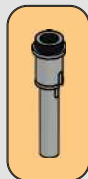

74





1x

75

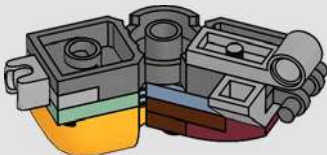



1x

76

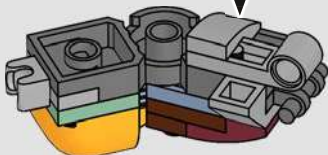
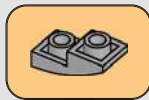

1x

77

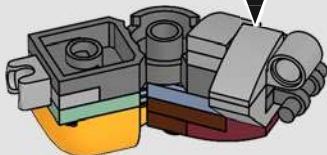



1x

78

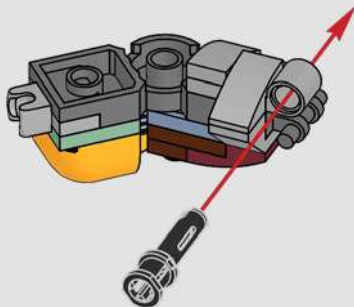



1x

79

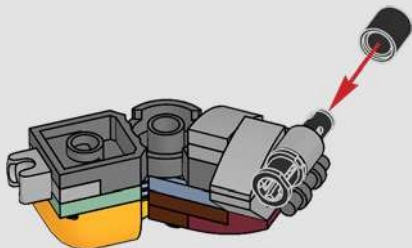



3x

80

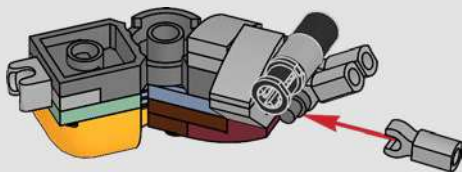

81

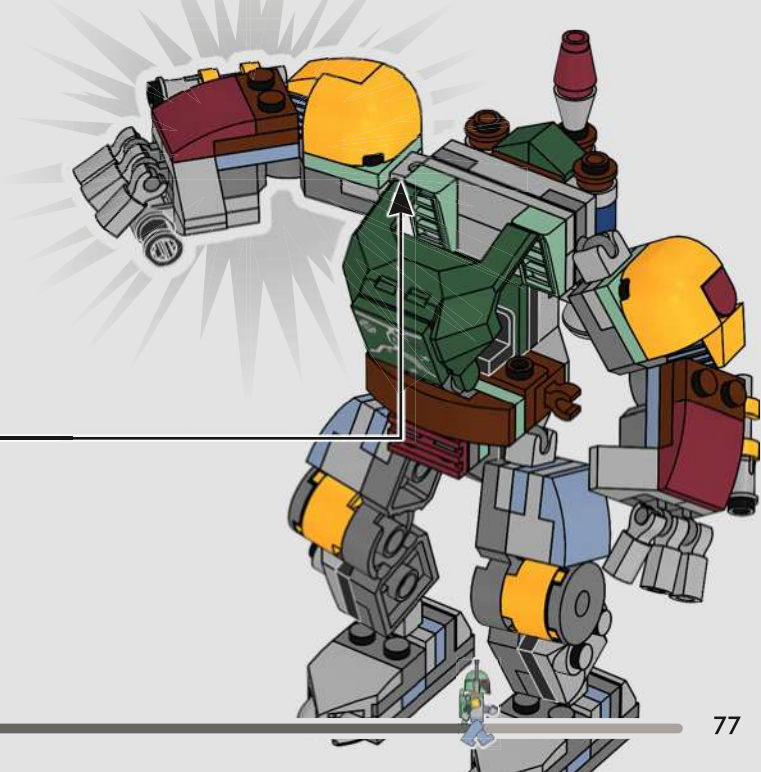



82

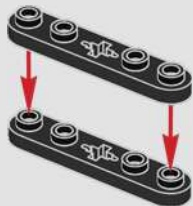



1x



1x

83

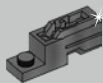
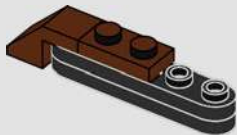

1x



1x

84

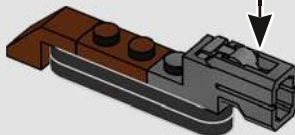
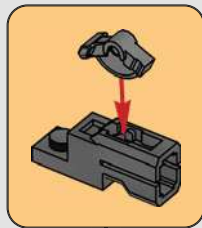

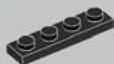

1x



1x

85

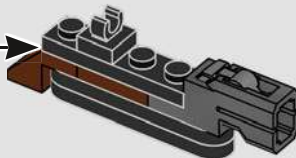
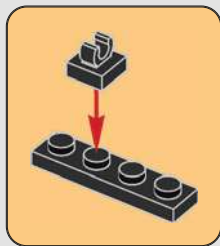



86

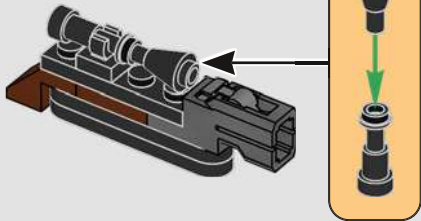

87

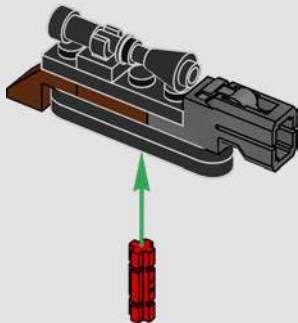

88





3x

89

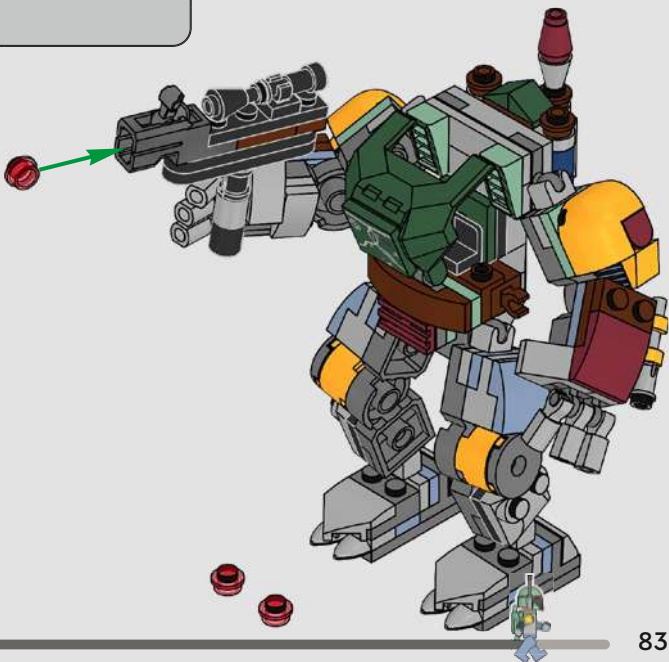

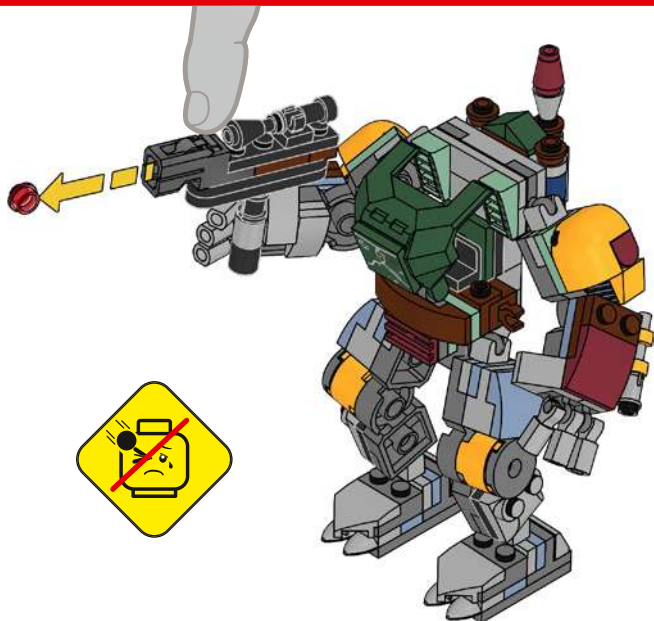

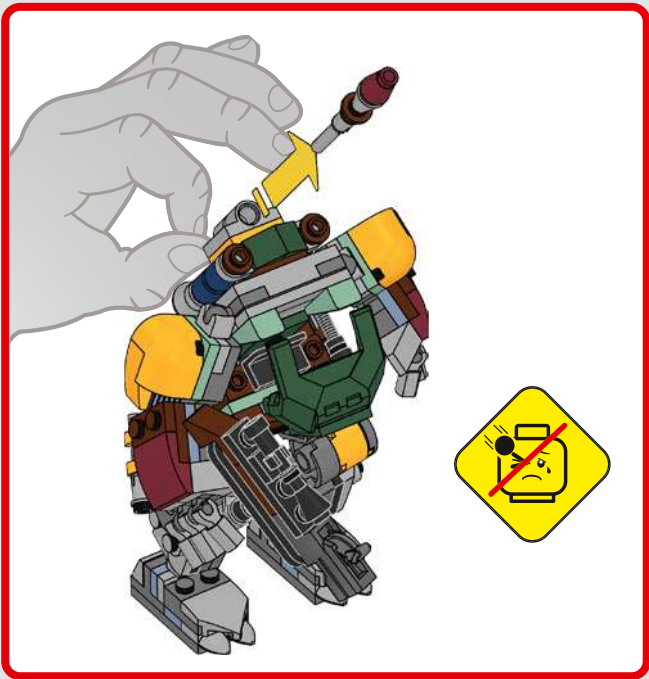

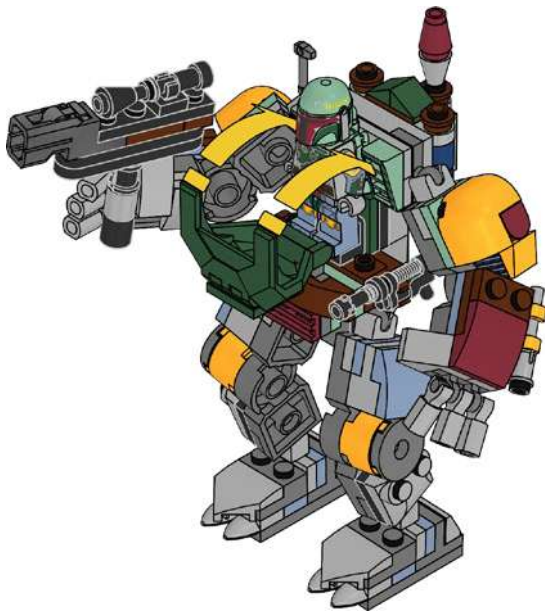

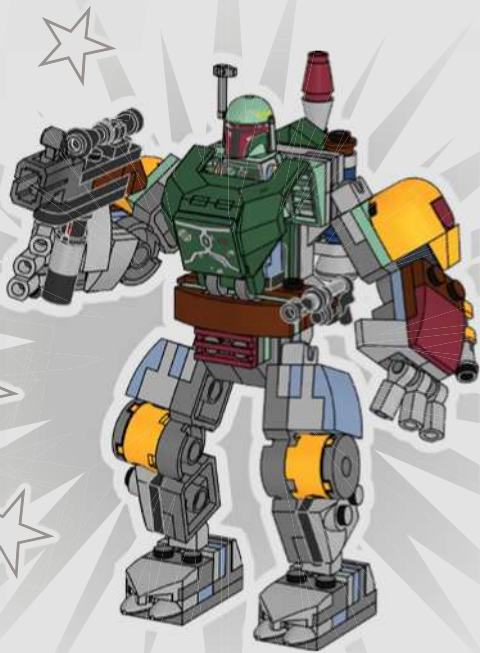



STAR WARS



75368



75369



75370



STAR WARS



75365



75360



75359



75361

 1x 6121485	 1x 4659662	 2x 6177135	 1x 6270089	 4x 4177741	 4x 6213644	 6x 6043656
 1x 6335388	 1x 6115086	 2x 6166865	 1x 4142865	 1x 6224778	 6x 6355025	 2x 4494475
 1x 6056234	 3x 302226	 9x 6198156	 2x 4504375	 1x 6444191	 2x 6213378	 2x 6326478
 1x 4598897	 1x 371026	 1x 6444195	 1x 4245570	 1x 6454781	 2x 6254404	 2x 4211429
 2x 6279875	 2x 6280168	 2x 6155256	 1x 6444189	 2x 6144138	 1x 6167667	 2x 6257593
 1x 4538456	 4x 6282619	 4x 6282619	 1x 6186827	 1x 6438836	 3x 6347715	 2x 6456718
 1x 6321745	 1x 6039194	 1x 6444190	 1x 6452335	 1x 4211376	 2x 4568637	 1x 6452334



3x
6215659



2x
6325717



1x
6248854



5x
4211150



1x
6174856



2x
6443654



1x
4658005



3x
6208450



1x
6023173



1x
6099728



2x
6337271



1x
6392165



2x
6452397



2x
6393826



1x
6322997



1x
4541498



1x
4541506



2x
6107758



1x
6360675



2x
6055313



2x
6069164



6x
6039479



2x
4210660



2x
6336990



2x
6250018



2x
6352694



1x
6345952



2x
4211065



1x
6461466



4x
6395097



[LEGO.com/service](https://www.LEGO.com/service)

YOU COULD

WIN



Scan this QR code or go to
LEGO.COM/PRODUCTFEEDBACK and give us
your short feedback about this LEGO® set
for a chance to win a cool LEGO prize.

Terms and Conditions apply*

EN: YOU COULD WIN. Terms and Conditions apply* **DE: Du könntest GEWINNEN.** Es gelten die Teilnahmebedingungen* **FR: Tu pourrais GAGNER.** Des conditions s'appliquent* **IT: Potresti VINCERE tu.** Termini e condizioni sono applicabili* **ES: Puedes GANAR.** Aplican términos y condiciones* **PT: Poderá GANHAR.** Aplicam-se termos e condições* **ZH: 轻松获奖.** 条款和条件适用* **PL: Szansa na WYGRANĄ.** Obowiązują warunki korzystania* **CS: Máte šanci VYHRÁT.** Platí všeobecné smluvní podmínky* **SK: Máte šancu VYHRÁT.** Platia všeobecné zmluvné podmienky* **HU: TE IS NYERHETSZ.** Felhasználási feltételek érvényesek* **RO: Ai putea CÂȘTIGA.** Se aplică termenii și condiții* **BG: Можете да СПЕЧЕЛИТЕ.** Има определени правила и условия* **LV: Tu vari LAIMĒT.** Ir spēkā noteikumi un nosacījumi.* **ET: Sul on võimalus VÕITA.** Kehtivad tingimused* **LT: Jūs galite LAIMĖTI.** Taikomos sąlygos*

*[LEGO.com/productfeedback-terms](https://www.lego.com/productfeedback-terms)

LEGO and the LEGO logo are trademarks of the/sont des marques de commerce du/son marcas registradas de LEGO Group. ©2023 The LEGO Group.

© & ™ Lucasfilm Ltd.

6475507