



MINECRAFT

21252



LEGO® Builder



Get excited about our new packaging!

We're switching from plastic to paper-based packaging. That's why you might find a mix of paper and plastic in our boxes!

Nos nouveaux emballages vous emballeront !

Nous passons des emballages en plastique aux emballages à base de papier. C'est pourquoi vous pourriez trouver un mélange de papier et de plastique dans nos boîtes !

¡Te presentamos nuestros nuevos empaques!

Estamos sustituyendo las bolsas de plástico por bolsas con base de papel. ¡Por eso, puedes encontrar una mezcla de papel y de plástico en nuestras cajas!

[LEGO.com/sustainable-packaging](https://www.lego.com/sustainable-packaging)

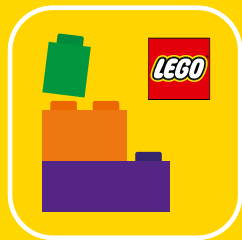

Q LEGO® Builder

BUILDER



Apple and the Apple logo are trademarks of Apple Inc., registered in the U.S. and other countries and regions. App Store is a service mark of Apple Inc. Google Play and the Google Play logo are trademarks of Google LLC. Tencent and the Tencent logo are trademarks of Tencent Inc.

Q LEGO.com/devicecheck

EN Ask parents' permission before going online | **DE** Eltern um Erlaubnis bitten, bevor du online gehst | **FR** Demande l'autorisation d'un parent avant d'aller en ligne | **IT** Chiedi il permesso ai tuoi genitori prima di andare online | **ES** Pídeles permiso a tus papás antes de conectarte a Internet | **PT** Pede autorização aos pais antes de acederes online | **ZH** 上网前应先征得父母的同意 | **PL** Poproś rodziców o zgodę, zanim wejdiesz do Internetu | **CS** Než půjdeš na internet, požádej rodiče o svolení | **SK** Skôr než pôjdeš na internet, vypýtaj si povolenie od rodičov | **HU** Kérj szülői engedélyt, mielőtt online csatlakoznál! | **RO** Cere permisiunea părinților înainte de a te conecta online | **BG** Поискайте разрешение от родител, преди да влезете онлайн | **LV** Pirms došanās tiešsaistē palūdz atļauju vecākiem | **ET** Enne Interneti kasutamist küsi vanematelt luba | **LT** Prieš prisijungdami prie interneto, atsiklauskite tėvų



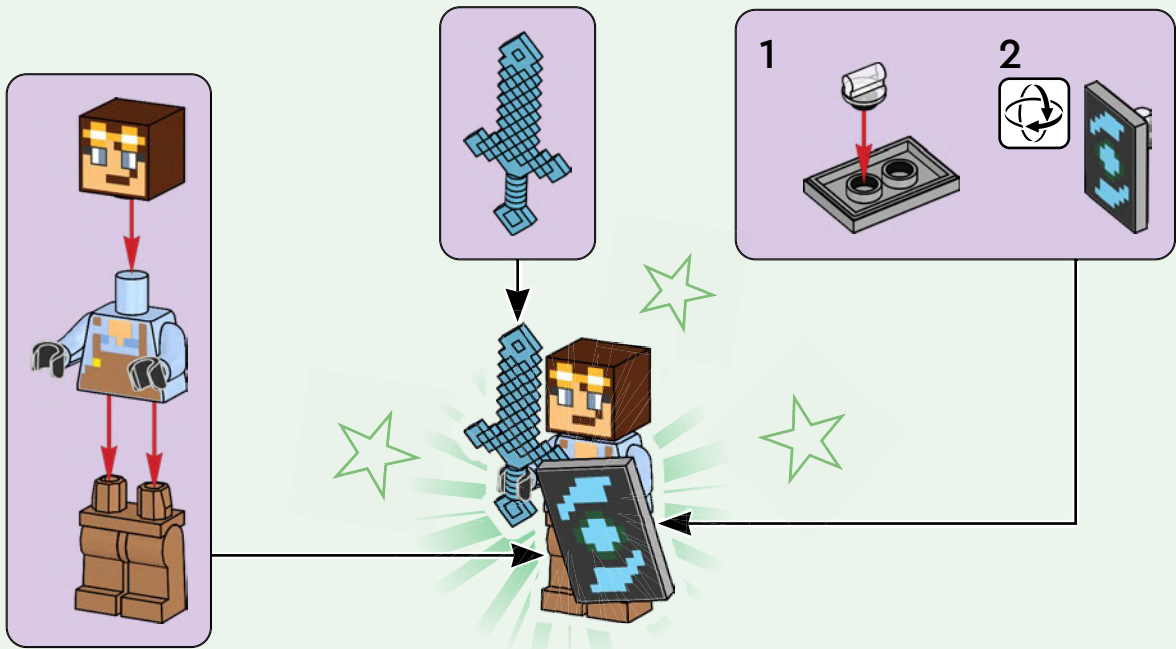

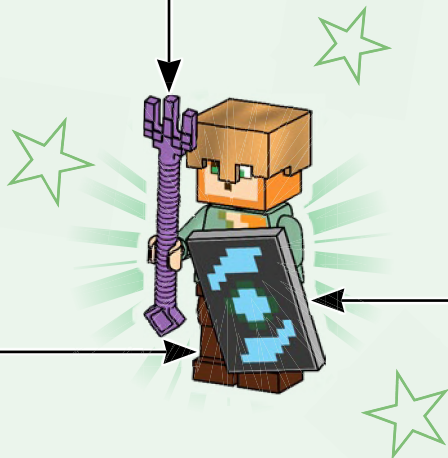
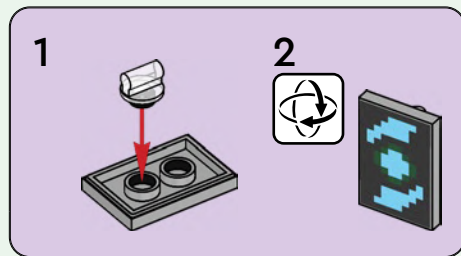
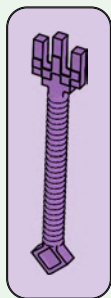
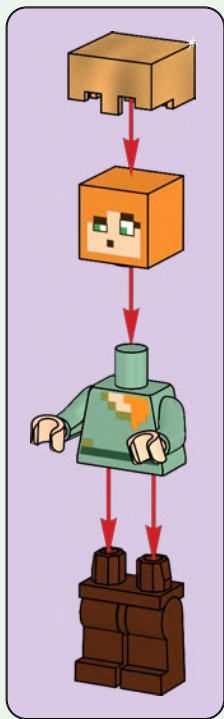

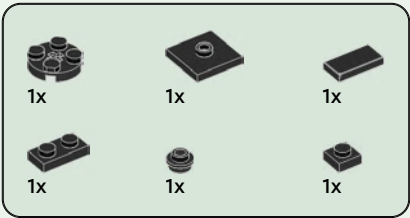

1

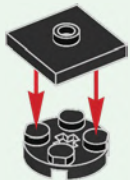

2

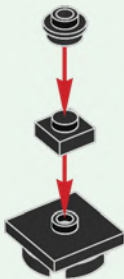

3

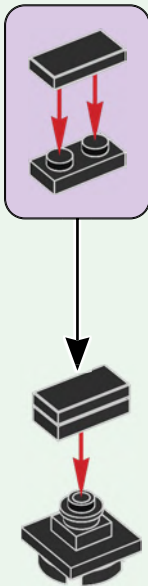

4



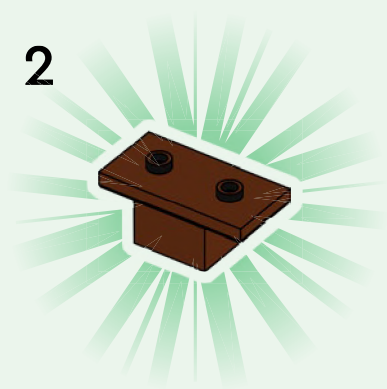
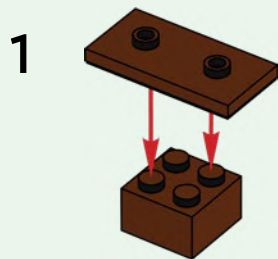
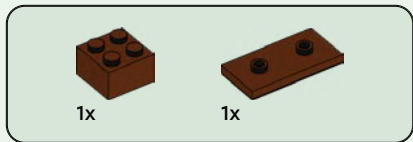

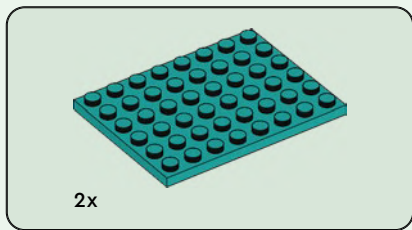
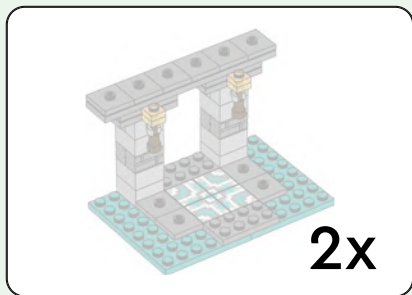

1

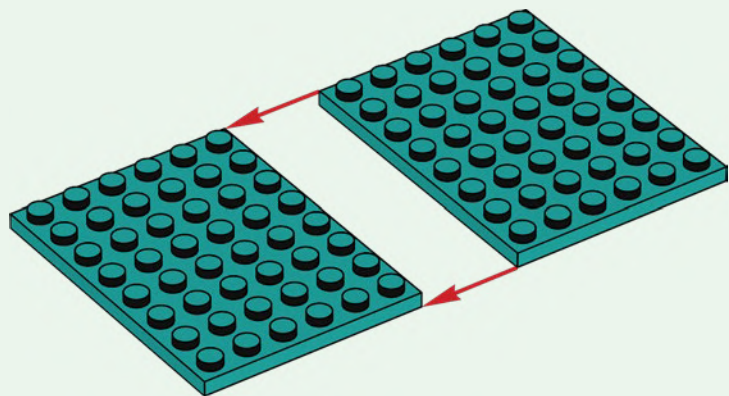



2x

2

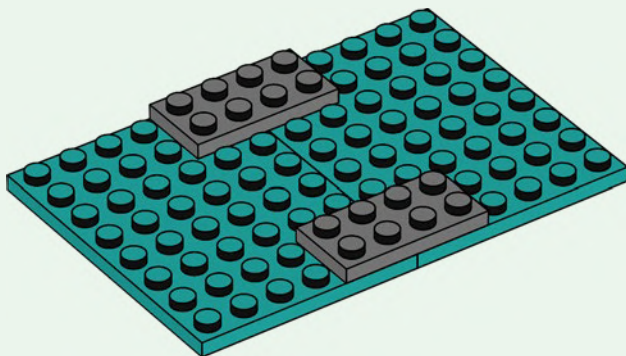



4x

3

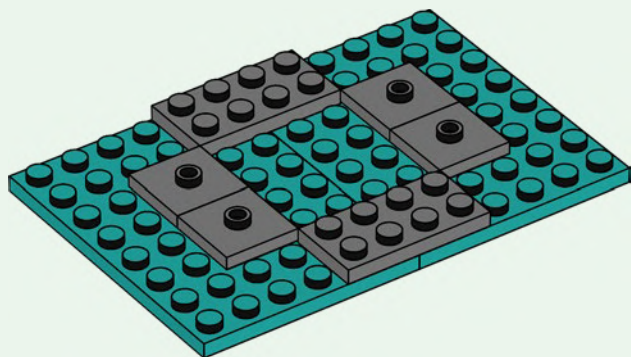

4x

4

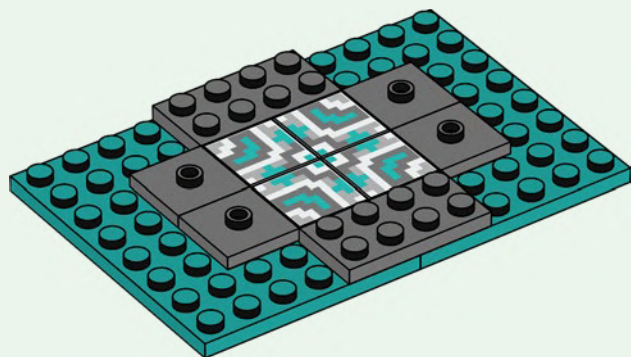



2x



6x



4x



2x



2x

5

1

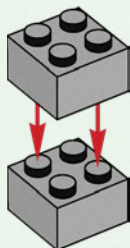

2

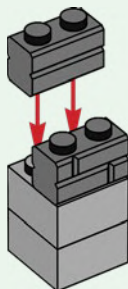

3

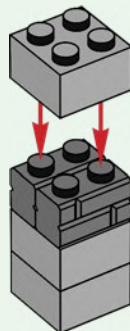

4

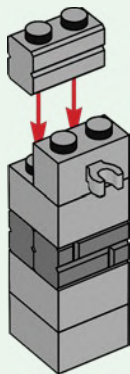

2x

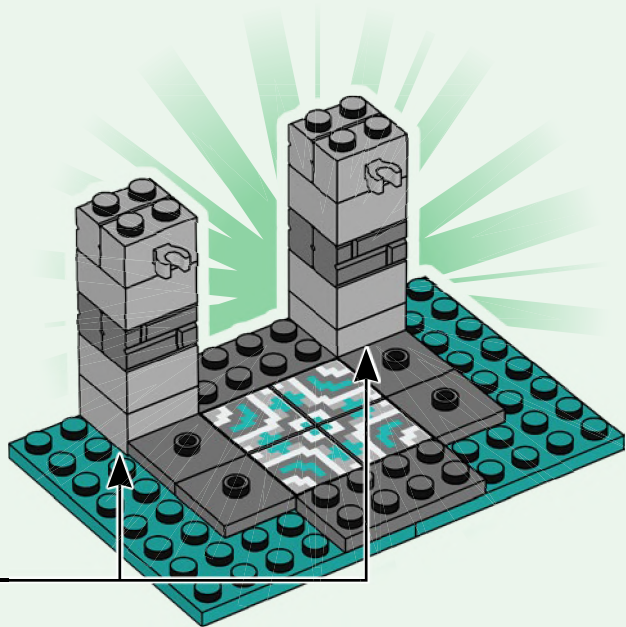

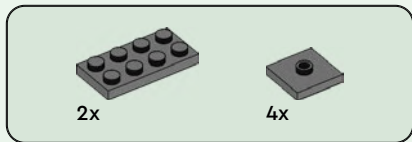

6

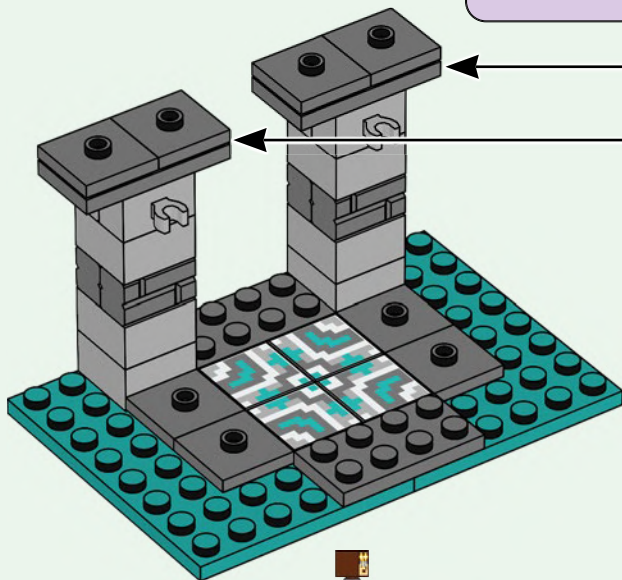
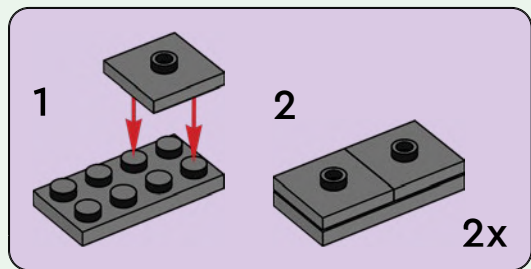

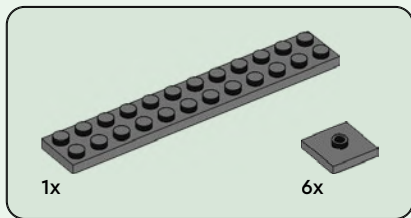

7

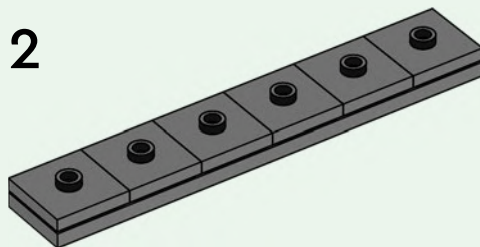
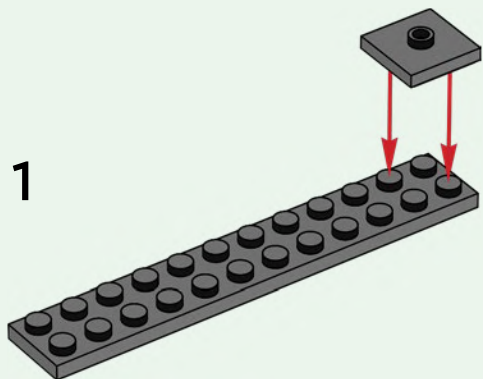

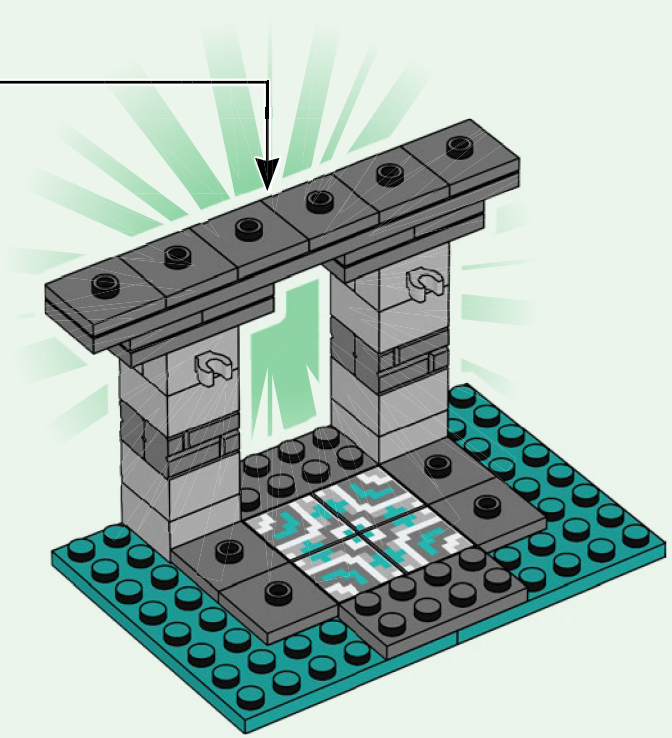



8

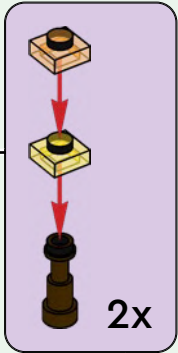
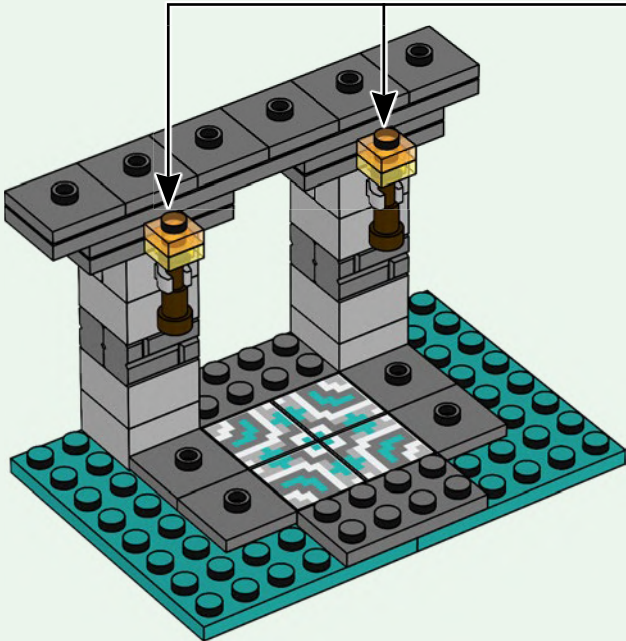

2x



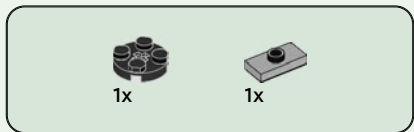

1

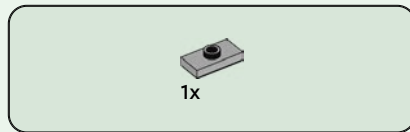
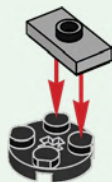

2





1x

3

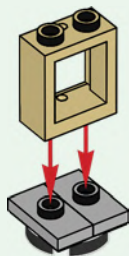

1x



1x

4

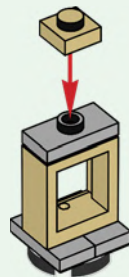

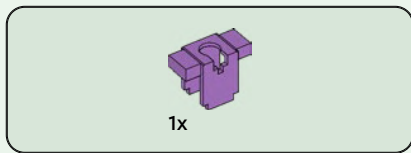

5

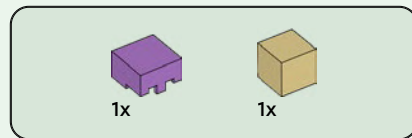
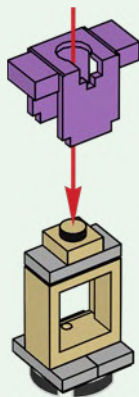

6

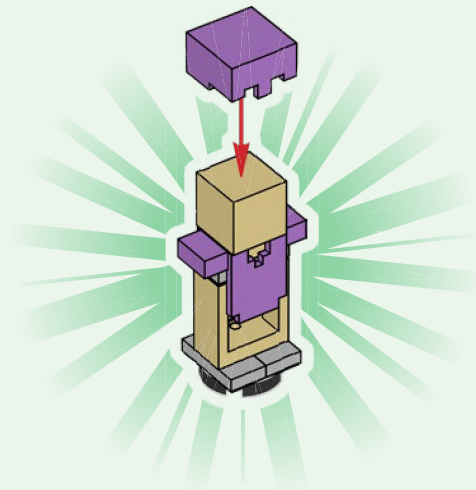



1x



1x

1

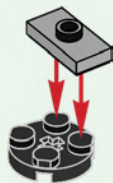

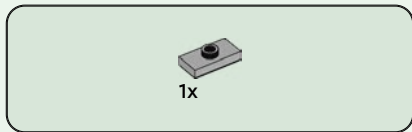

2

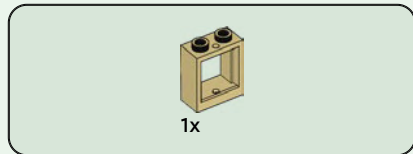

3

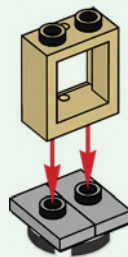



1x



1x

4

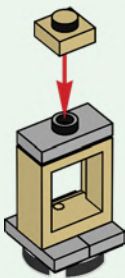

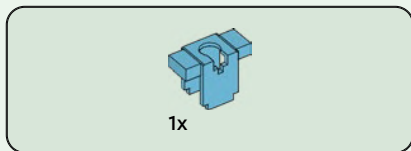

5

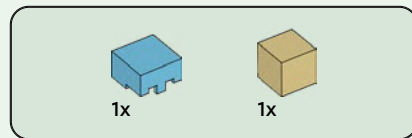
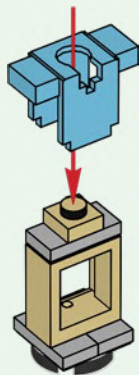

6

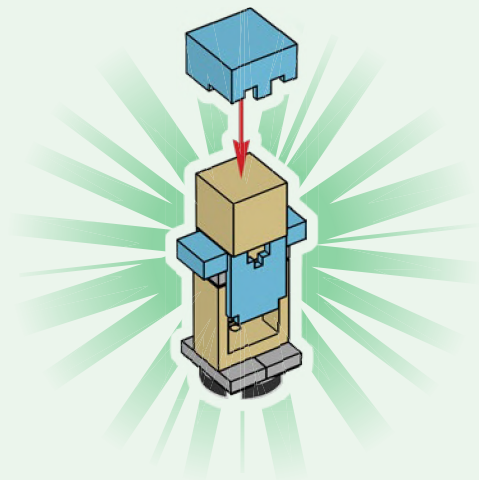

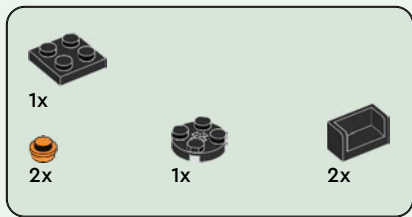

1

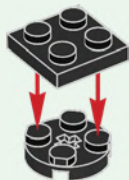

2

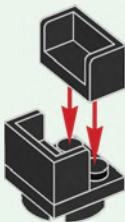

3

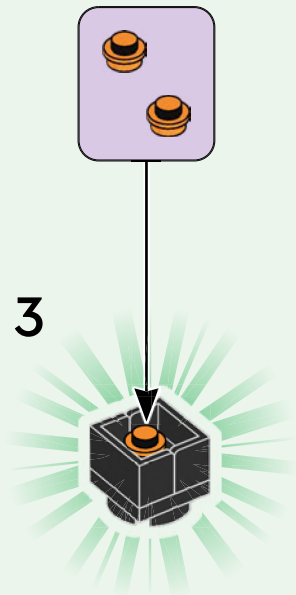

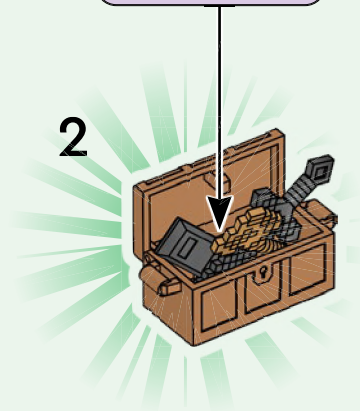
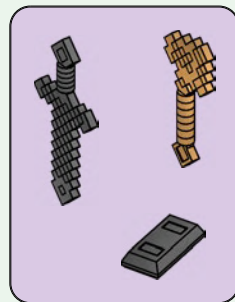
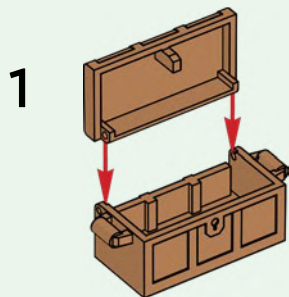
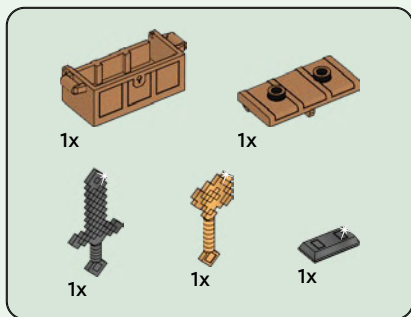

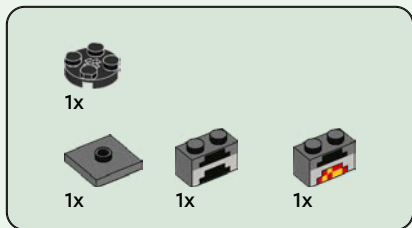

1

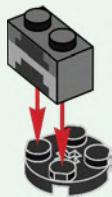

2



3





1x



1x

1

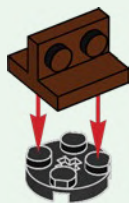

2x

2

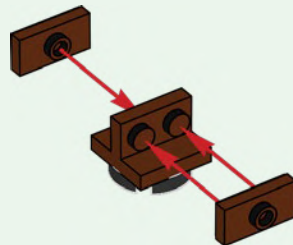



1x



1x

3

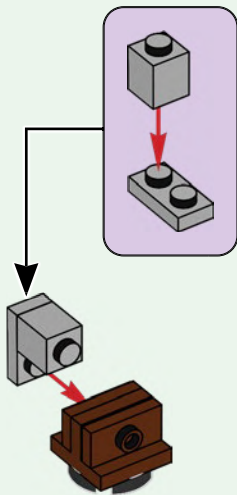

1x

4

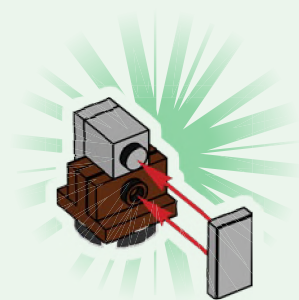

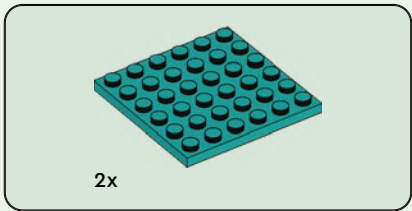
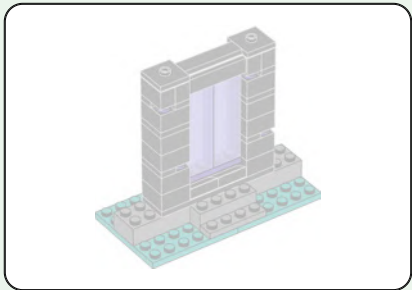

1

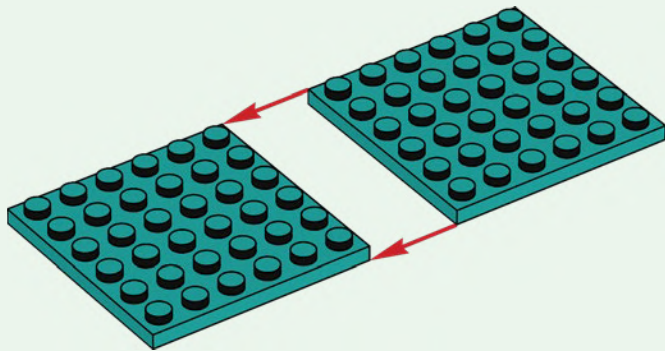



2x

2

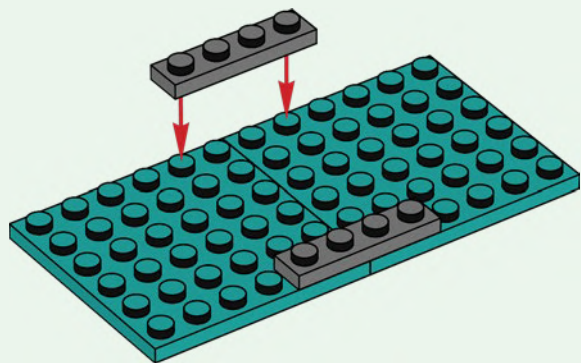

2x

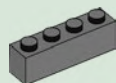

2x

3

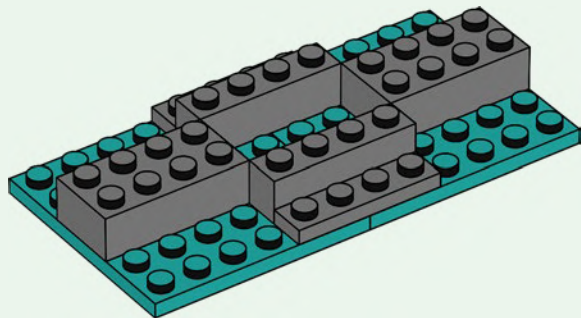

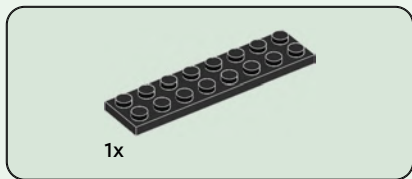

4

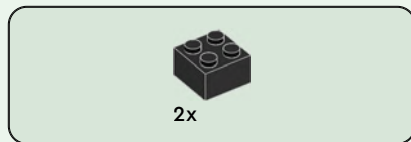
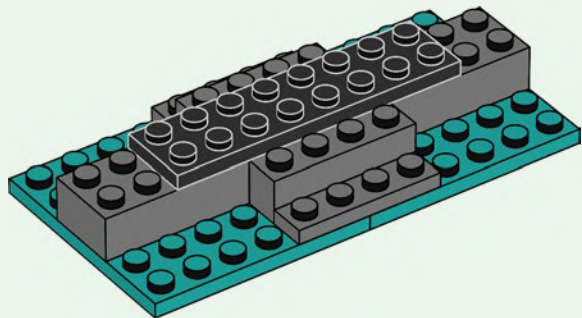

5

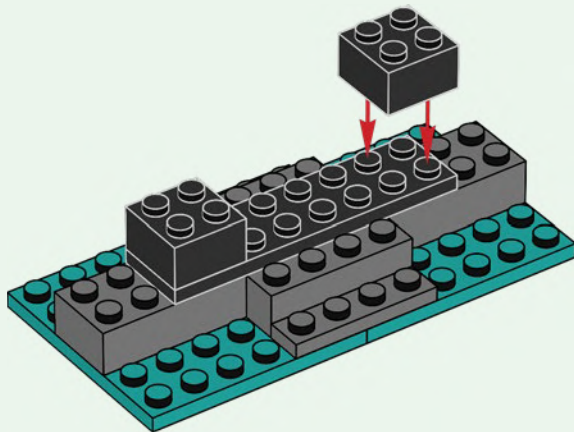



4x

6

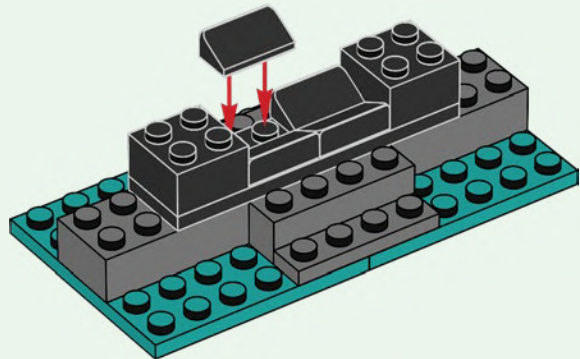

2x

7

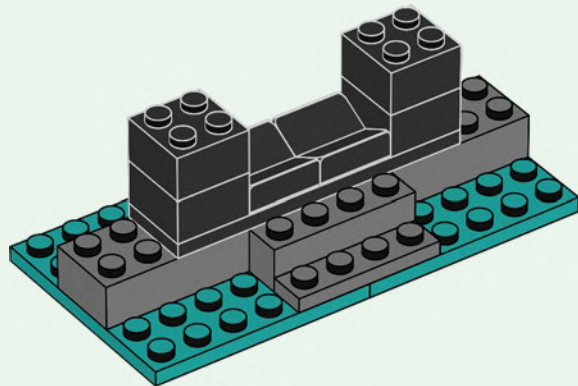



2x



2x

8

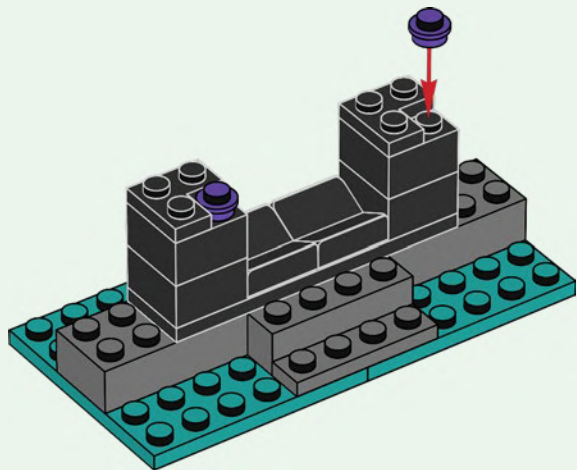

2x

9

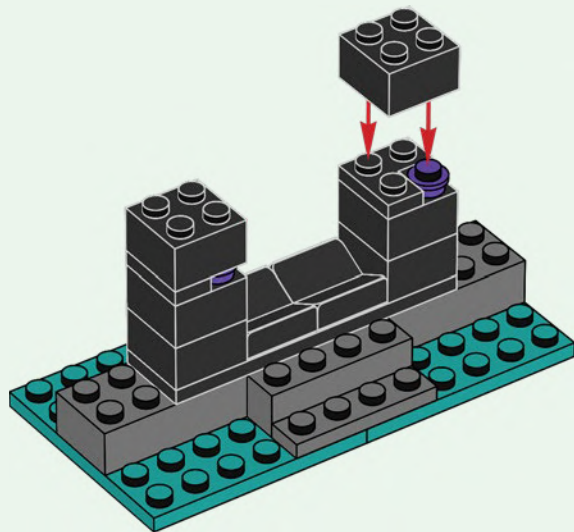



2x

10

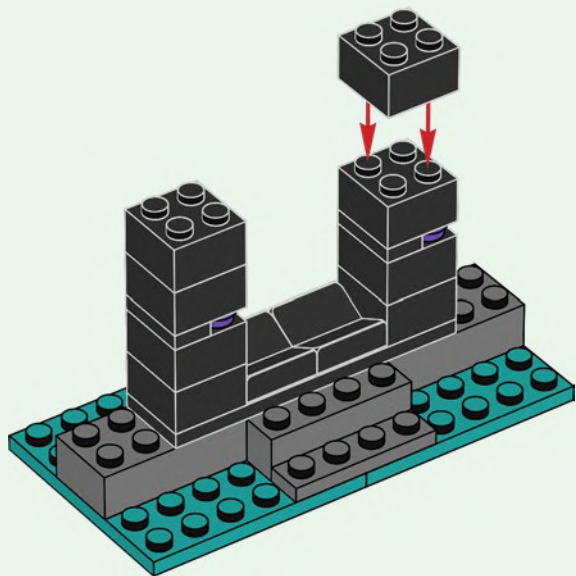

2x



2x

11

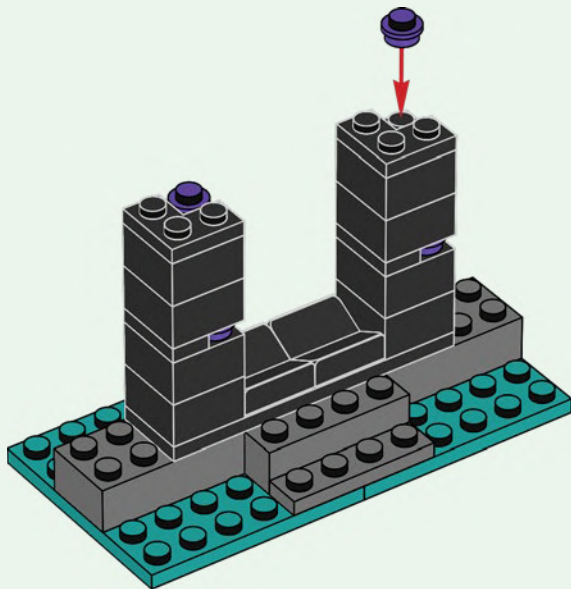

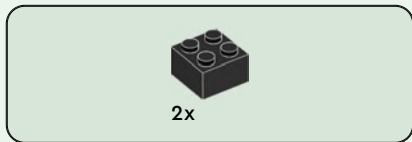

12

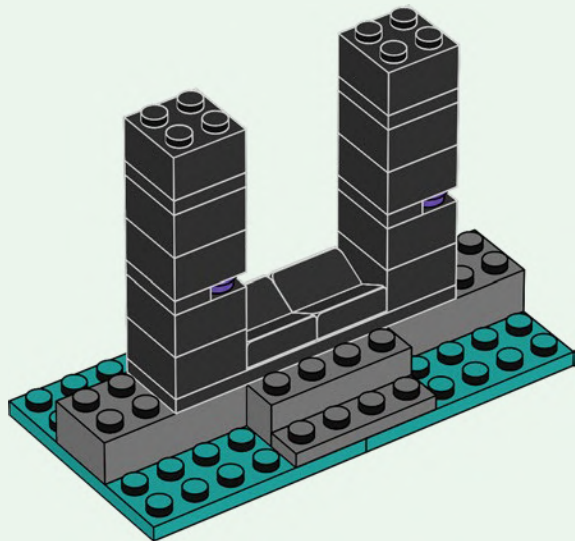

13

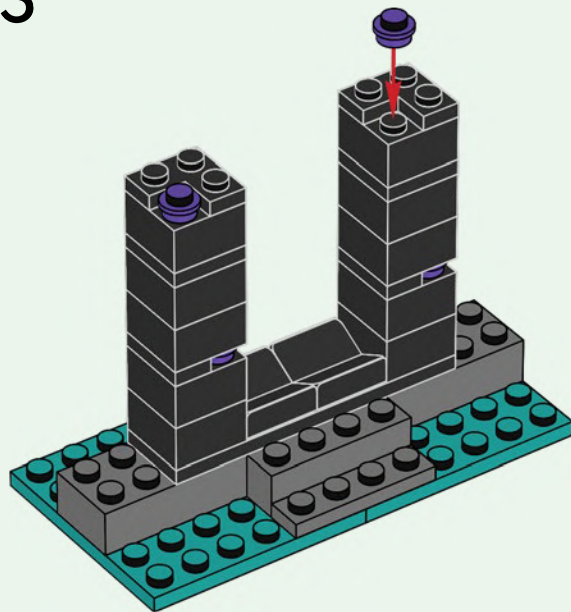

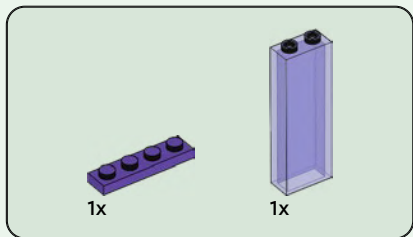

14

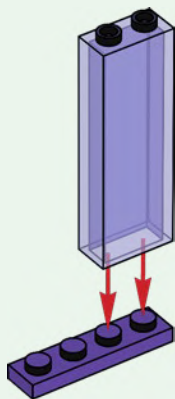

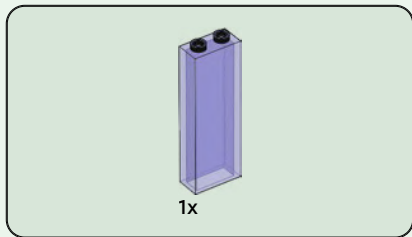

15

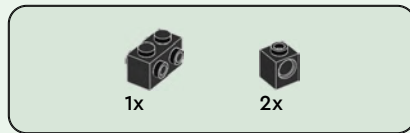
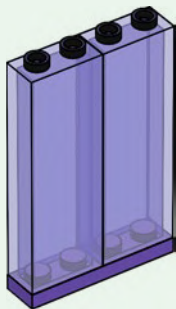

16

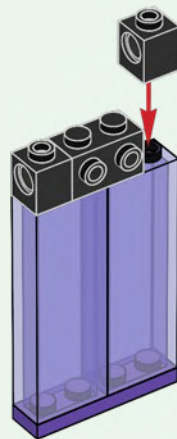



1x

17

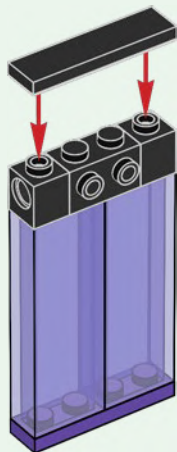

2x

18

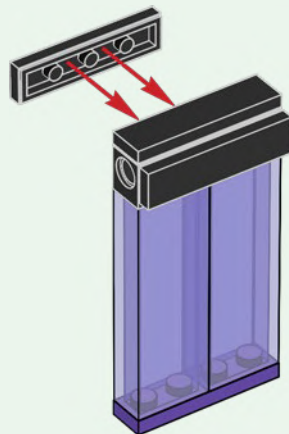



2x

19

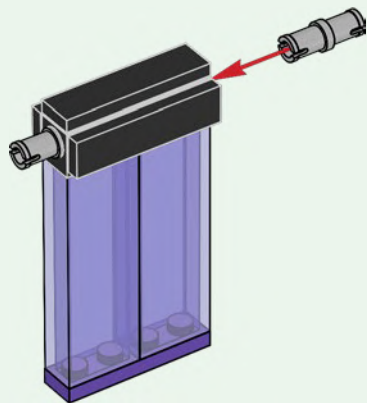

2x

20

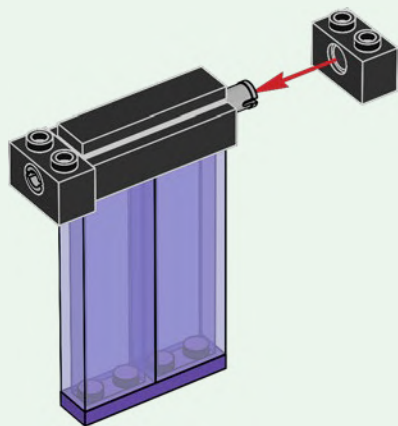

21

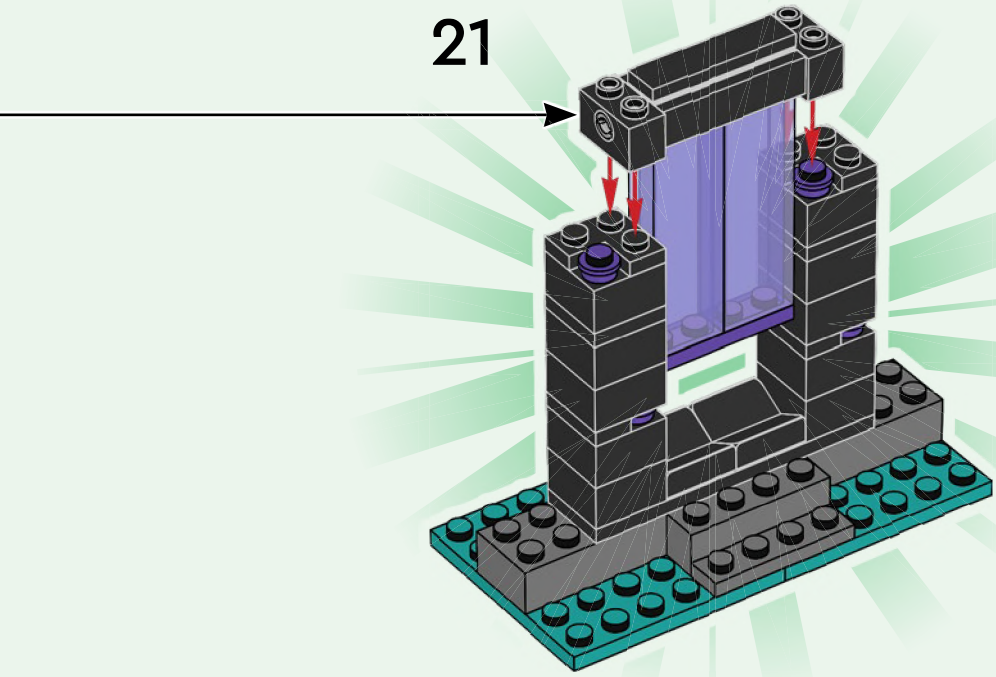



2x

22

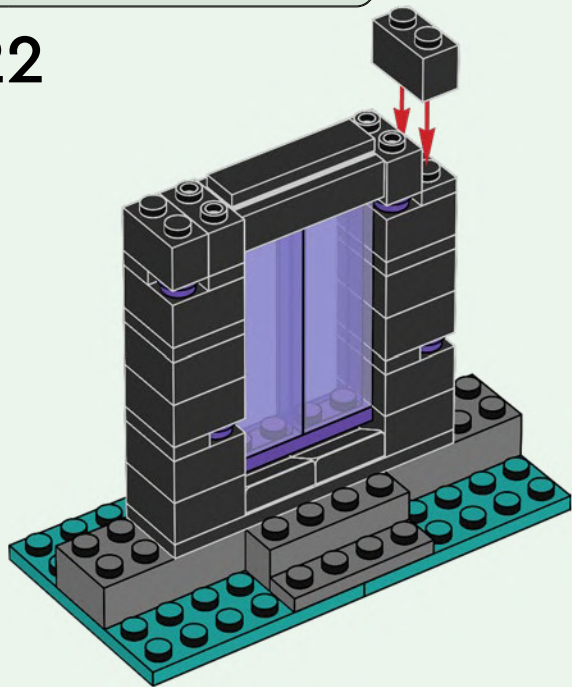

2x

23

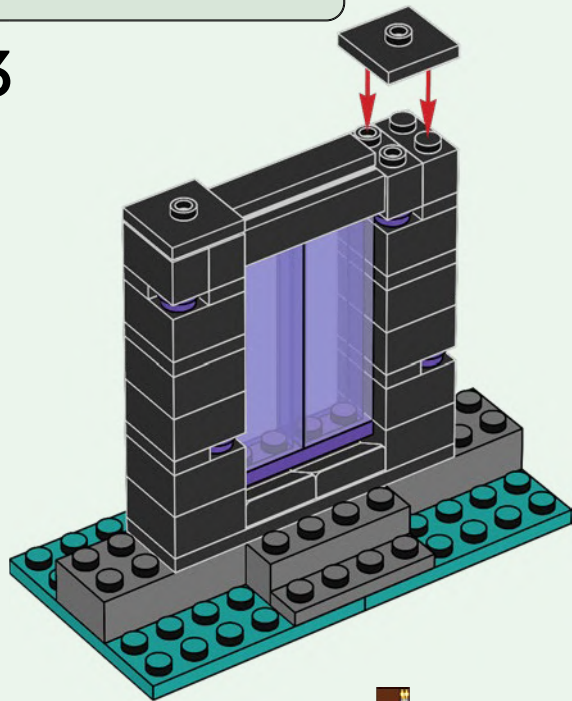

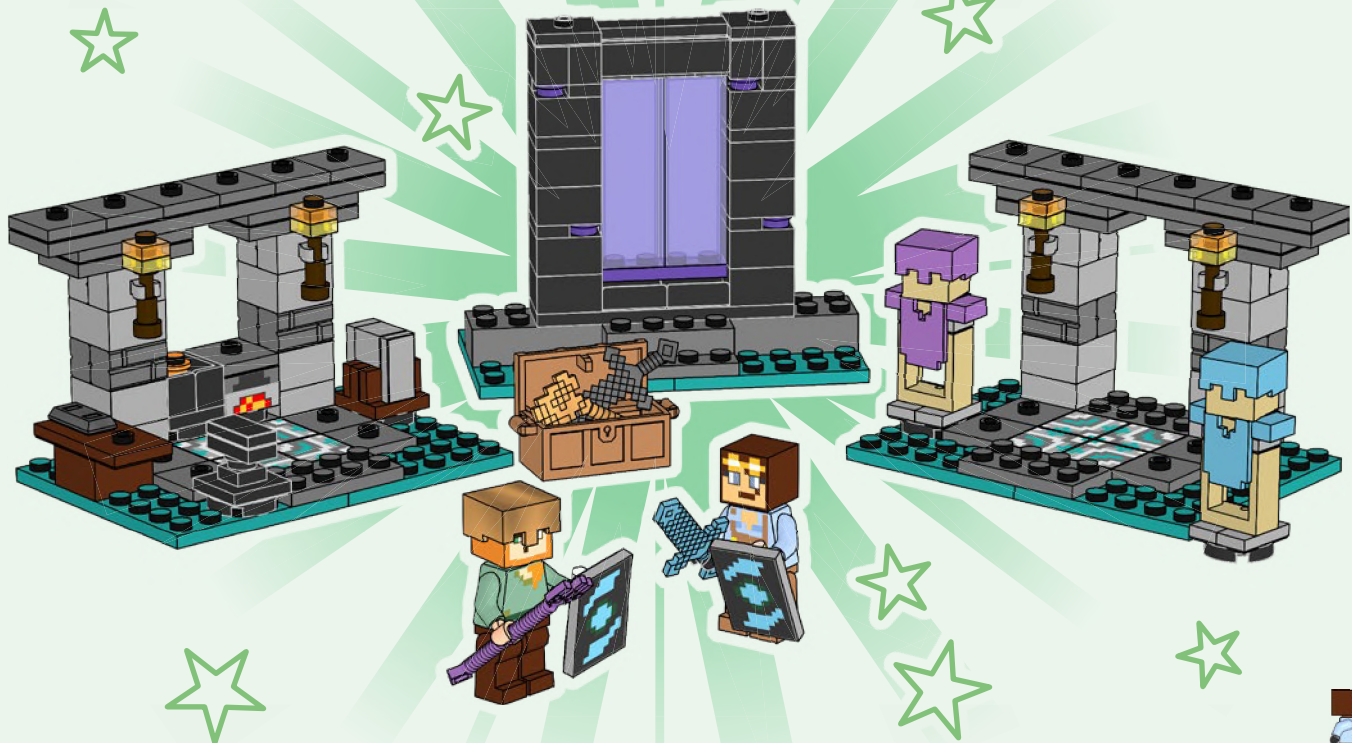



Rebuild
the
world™





MINECRAFT

21256



21257



21251



21255



21252



21254



21253





MINECRAFT

Combine sets to expand your play!

Combiner les ensembles pour
encore plus de jeu !

¡Combina sets para jugar
mucho más!

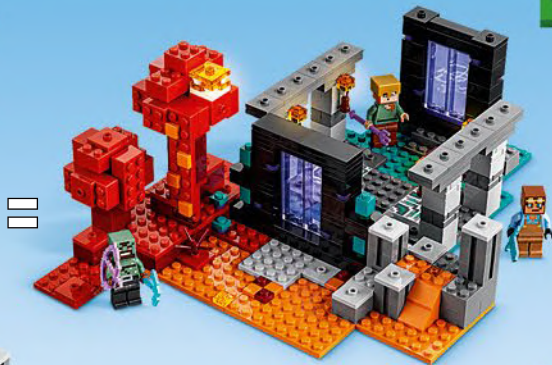
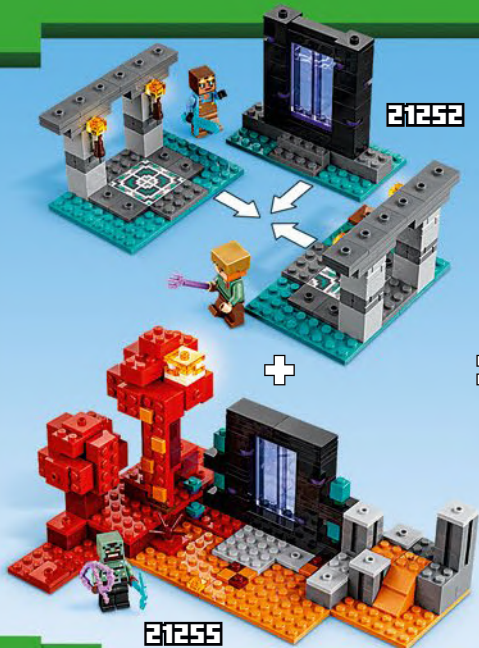



+

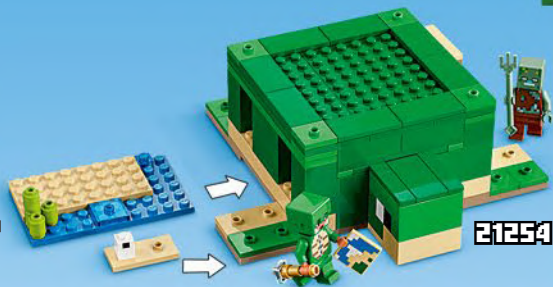

=





Rebuild
the
world™





8x
6468480



2x
4159553



2x
6387150



2x
6265236



2x
300426



10x
300326



1x
4253815



2x
654126



2x
370026



4x
4548180



1x
302426



1x
306926



1x
302326



3x
4565323



6x
242026



1x
302226



3x
243126



1x
6168646



1x
4211389



6x
403226



2x
6248496



2x
6359231



4x
6252045



2x
4157103



1x
6468460



1x
6121832



4x
6252040



1x
4211210



2x
6092590



1x
6468462



1x
4221886

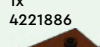

1x
6307618



1x
6290983



4x
4538950



4x
6000066



1x
4211398



4x
4211103



4x
6320297



6x
6066097



1x
4211414



12x
4211387



2x
6468461



2x
4211807



1x
6216860



1x
6216862



8x
6000311



2x
4211103



2x
4211085



29x
6126083



2x
4211001



8x
4211065



1x
6350506



1x
6208447



1x
6470874



1x
6167464



6x
4566522



1x
6469296



1x
6394966



1x
6262262



1x
6394960



1x
6102984



1x
6192828



1x
6093623



1x
6229024



1x
6192830



1x
6431792



1x
6469294



2x
6350502



1x
303426



4x
6424456



2x
6251830



2x
4211067



1x
303426

 [LEGO.com/service](https://www.LEGO.com/service)



YOU COULD
WIN

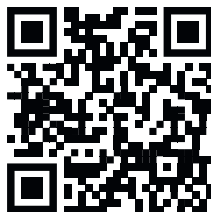

Scan this QR code or go to
LEGO.COM/PRODUCTFEEDBACK and give
us your short feedback about this LEGO® set
for a chance to win a cool LEGO prize.

Terms and Conditions apply*



EN: YOU COULD WIN. Terms and Conditions apply* **DE: Du könntest GEWINNEN.** Es gelten die Teilnahmebedingungen* **FR: Tu pourrais GAGNER.** Des conditions s'appliquent* **IT: Potresti VINCERE tu.** Termini e condizioni sono applicabili* **ES: Puedes GANAR.** Aplican términos y condiciones* **PT: Poderá GANHAR.** Aplicam-se termos e condições* **ZH: 轻松获奖. 条款和条件适用*** **PL: Szansa na WYGRANĄ.** Obowiązują warunki korzystania* **CS: Máte šanci VYHRÁT.** Platí všeobecné smluvní podmínky* **SK: Máte šancu VYHRAŤ.** Platia všeobecné zmluvné podmienky* **HU: TE IS NYERHETSZ.** Felhasználási feltételek érvényesek* **RO: Ai putea CÂȘTIGA.** Se aplică termenii și condiții* **BG: Можете да СПЕЧЕЛИТЕ.** Има определени правила и условия* **LV: Tu vari LAIMĒT.** Ir spēkā noteikumi un nosacījumi.* **ET: Sul on võimalus VÕITA.** Kehtivad tingimused* **LT: Jūs galite LAIMĖTI.** Taikomos sąlygos*

*[LEGO.com/productfeedback/terms](https://www.lego.com/productfeedback/terms)

LEGO and the LEGO logo are trademarks of the/sont des marques de commerce du/son marcas registradas de LEGO Group. ©2024 The LEGO Group.
© 2024 Mojang AB. All Rights Reserved. Minecraft, the Minecraft logo, the Mojang Studios logo and the Creeper logo are trademarks of the Microsoft group of companies.

6501787