



# DREAMZZZ

71475



Q LEGO® Builder



### **Get excited about our new packaging!**

We're switching from plastic to paper-based packaging. That's why you might find a mix of paper and plastic in our boxes!

### **Nos nouveaux emballages vous emballeront !**

Nous passons des emballages en plastique aux emballages à base de papier. C'est pourquoi vous pourriez trouver un mélange de papier et de plastique dans nos boîtes !

### **¡Te presentamos nuestros nuevos empaques!**

Estamos sustituyendo las bolsas de plástico por bolsas con base de papel. ¡Por eso, puedes encontrar una mezcla de papel y de plástico en nuestras cajas!

**[LEGO.com/sustainable-packaging](https://www.lego.com/sustainable-packaging)**

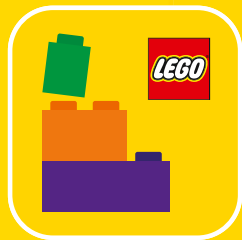

Q LEGO® Builder

# BUILDER



Apple and the Apple logo are trademarks of Apple Inc., registered in the U.S. and other countries and regions. App Store is a service mark of Apple Inc. Google Play and the Google Play logo are trademarks of Google LLC. Tencent and the Tencent logo are trademarks of Tencent Inc.

Q [LEGO.com/devicecheck](https://www.lego.com/devicecheck)

**EN** Ask parents' permission before going online | **DE** Eltern um Erlaubnis bitten, bevor du online gehst | **FR** Demande l'autorisation d'un parent avant d'aller en ligne | **IT** Chiedi il permesso ai tuoi genitori prima di andare online | **ES** Pídeles permiso a tus papás antes de conectarte a Internet | **PT** Pede autorização aos pais antes de acederes online | **ZH** 上网前应先征得父母的同意 | **PL** Poproś rodziców o zgodę, zanim wejdiesz do Internetu | **CS** Než půjdeš na internet, požádej rodiče o svolení | **SK** Skôr než pôjdeš na internet, vypýtaj si povolenie od rodičov | **HU** Kérj szülői engedélyt, mielőtt online csatlakoznál! | **RO** Cere permisiunea părinților înainte de a te conecta online | **BG** Поискайте разрешение от родител, преди да влезете онлайн | **LV** Pirms došanās tiešsaistē palūdz atļauju vecākiem | **ET** Enne Interneti kasutamist küsi vanematelt luba | **LT** Prieš prisijungdami prie interneto, atsiklauskite tėvų







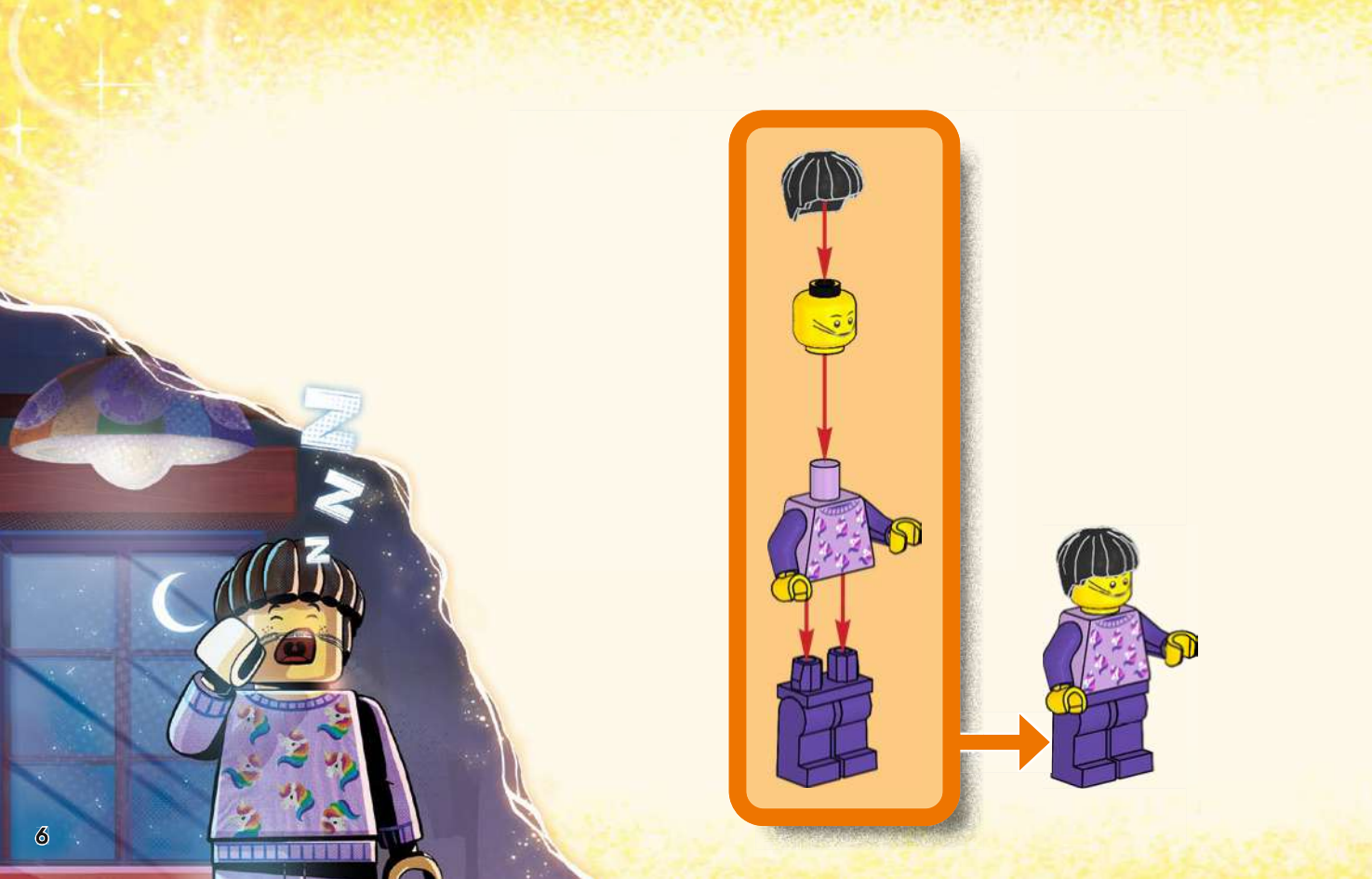





1x



1x

1



2x

2

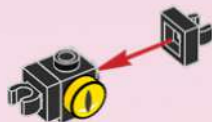

1x

3







4

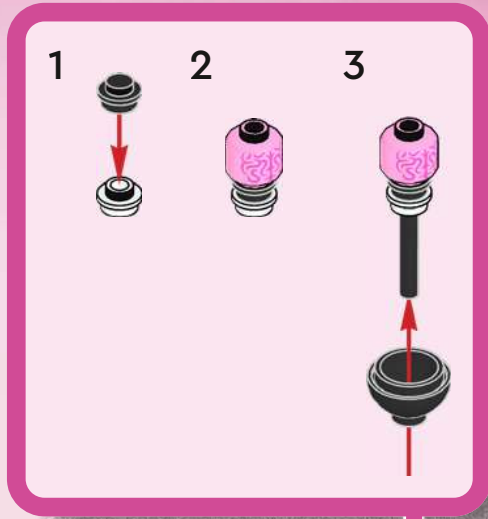



1x

5



2x

6



4x



4x

7

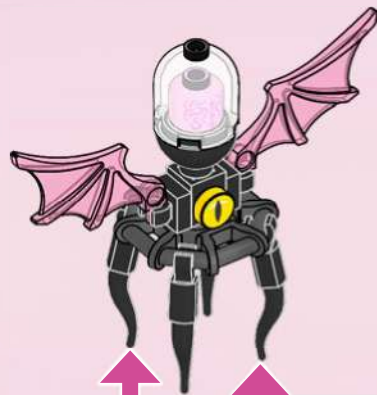

4x





1x



1x

1

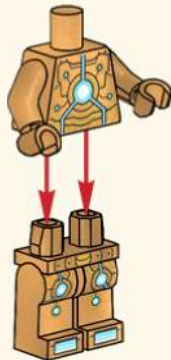





2

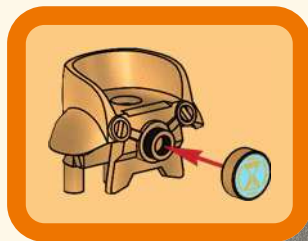



1x



1x

3

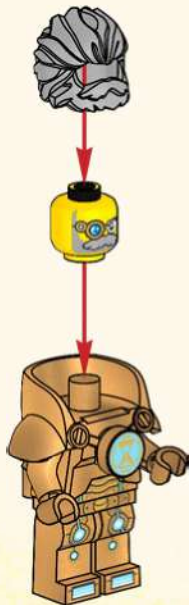

1x



1x

4





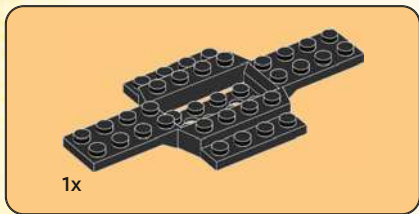
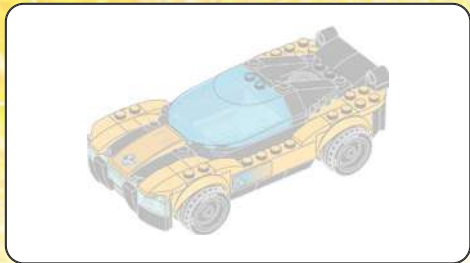

1

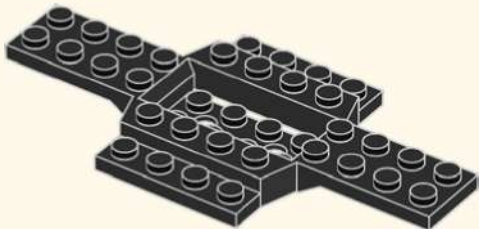



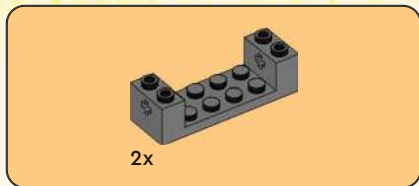

2

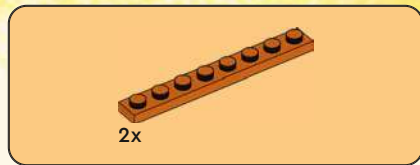
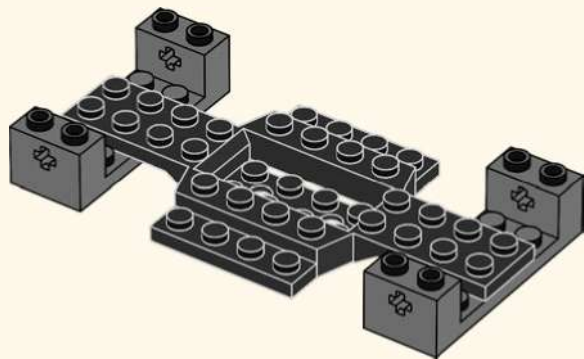

3

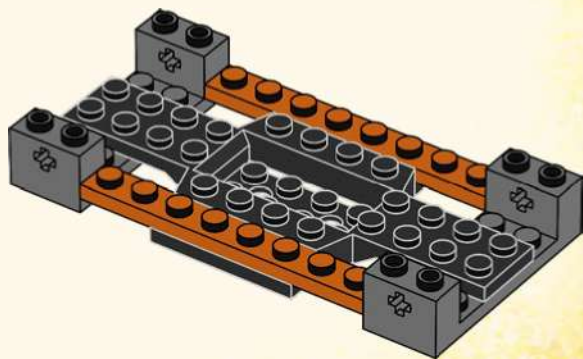

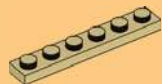

2x

4

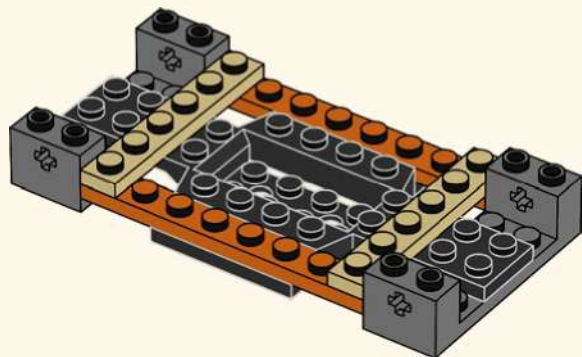

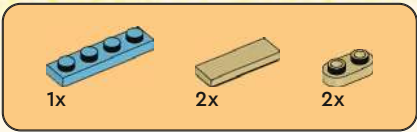

5

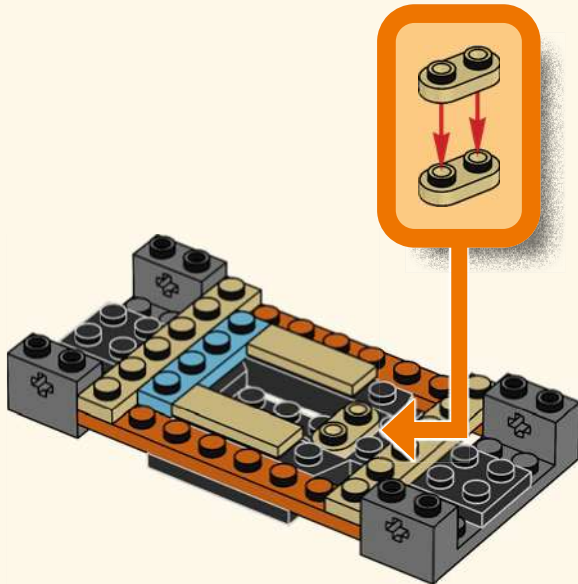

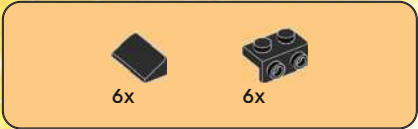

6

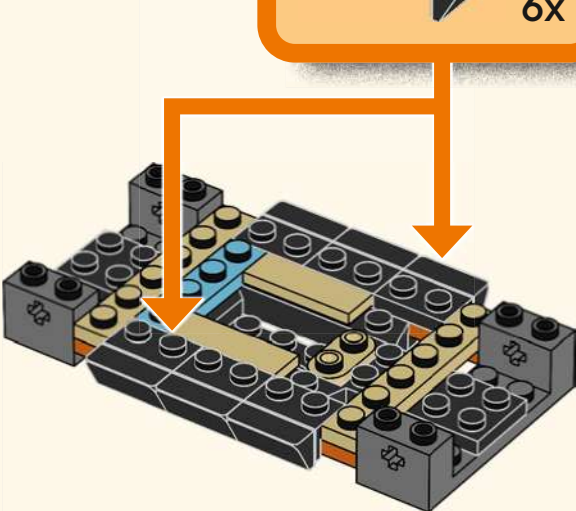
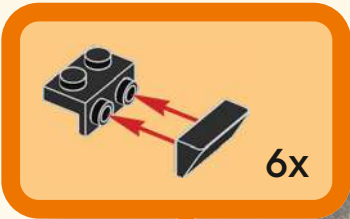



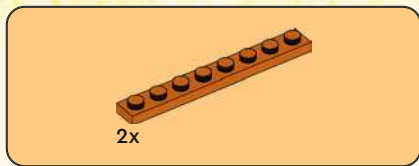

7

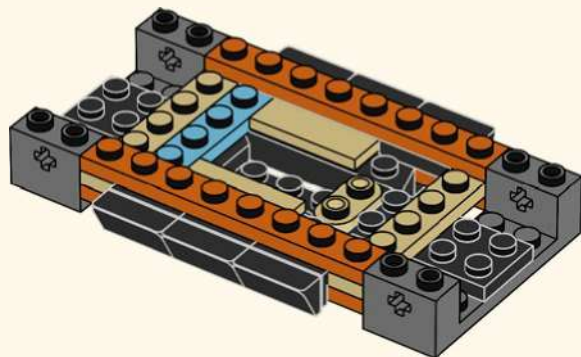

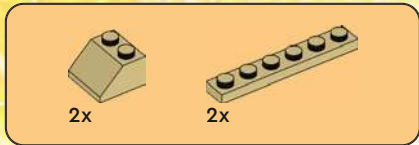

8

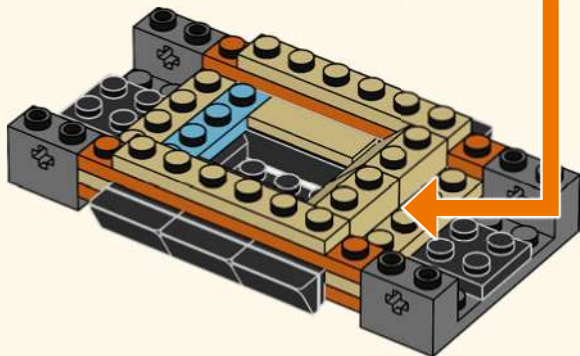

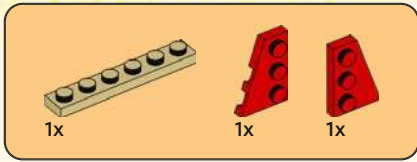

9

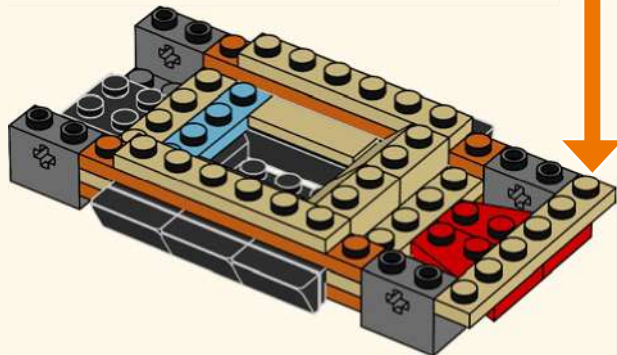
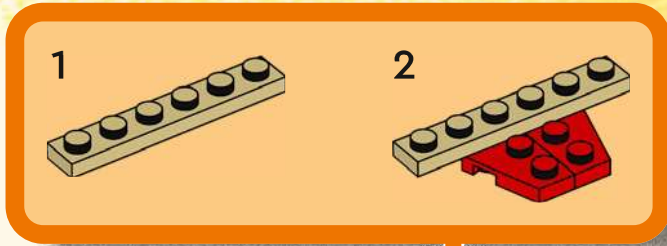



2x

10

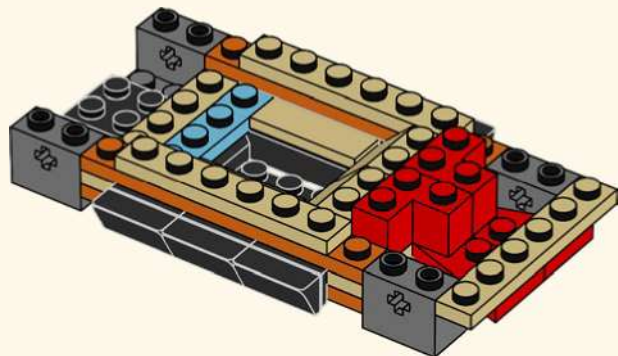



2x

11

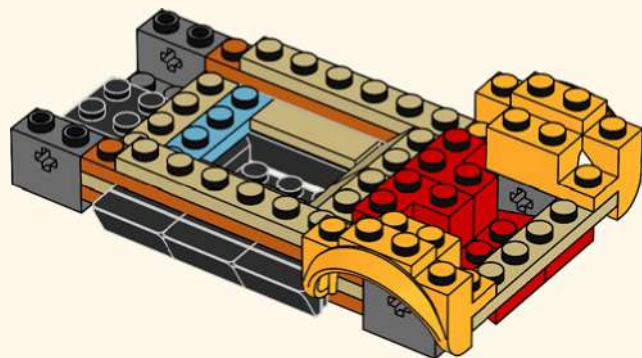



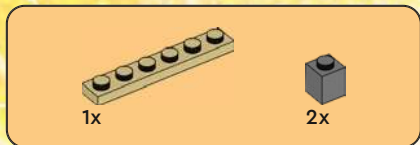

12

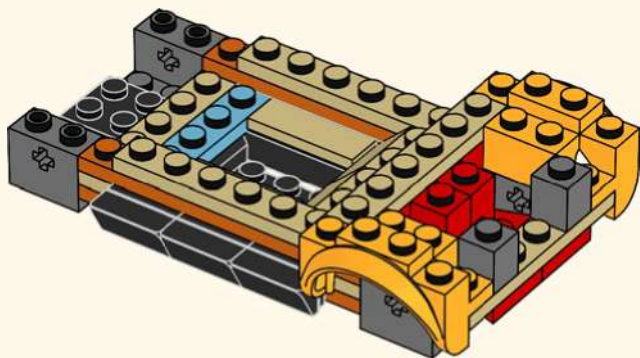

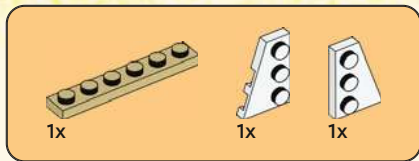

13

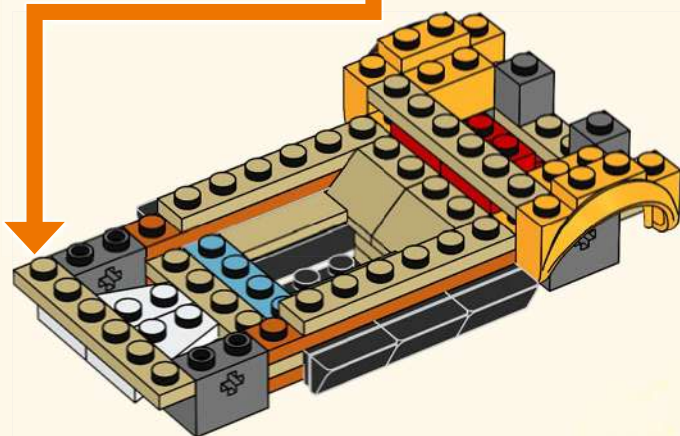
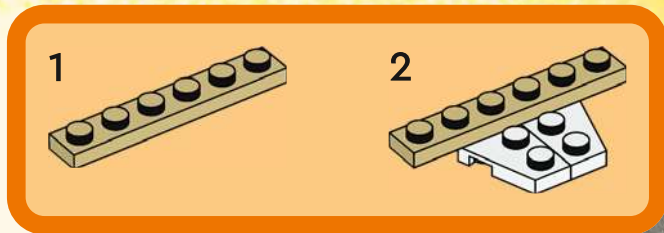



2x



1x

14

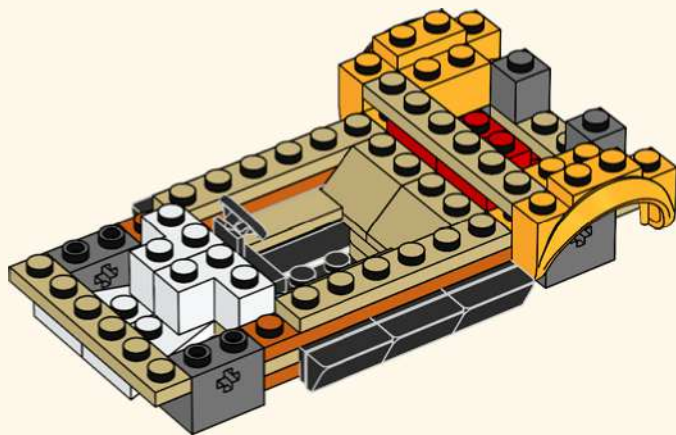



2x

15

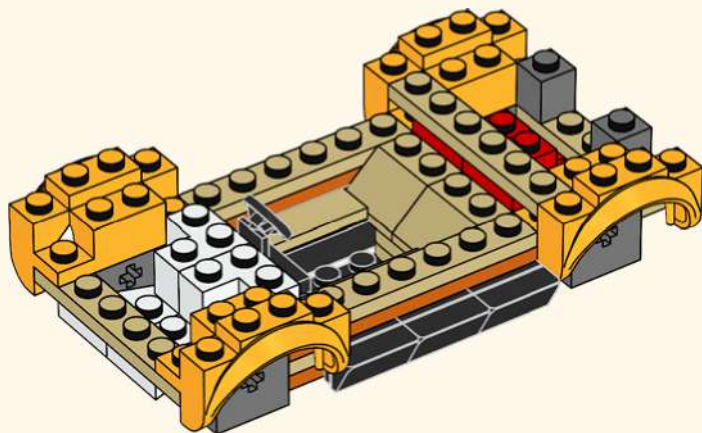

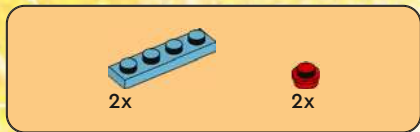

16

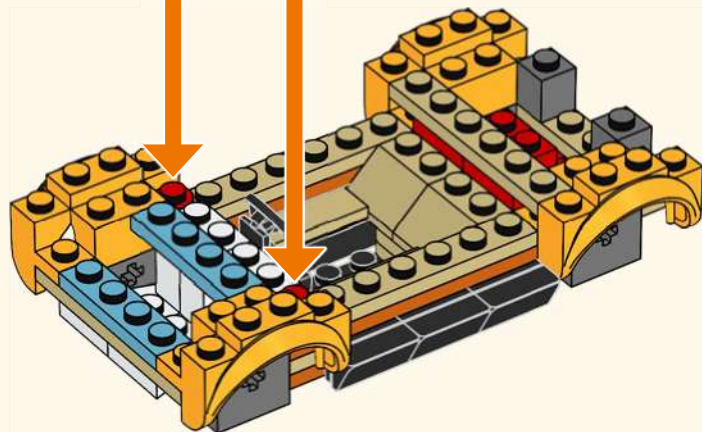



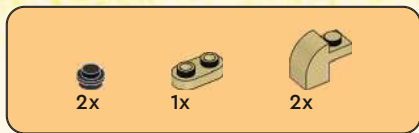

17

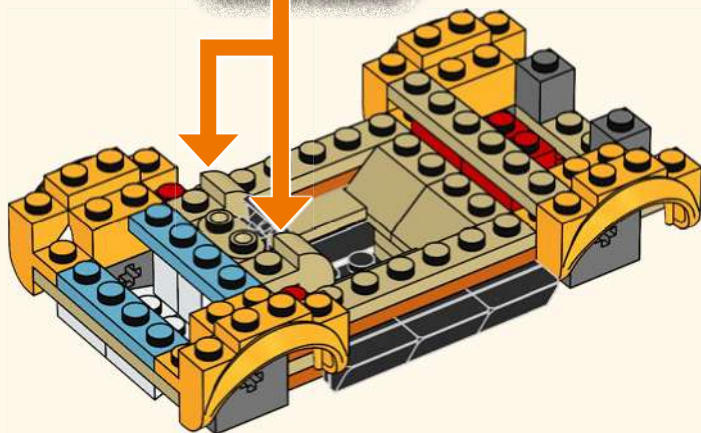
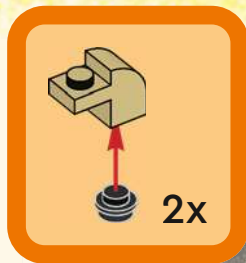

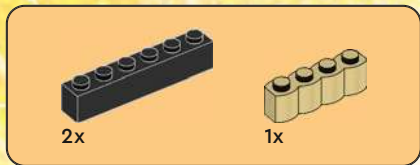

18

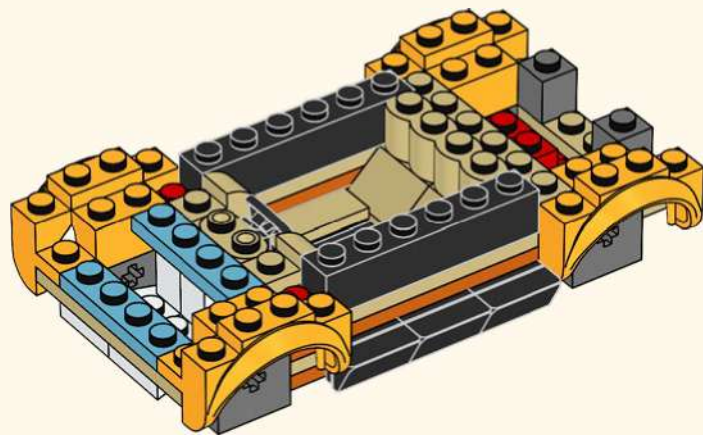



2x

19

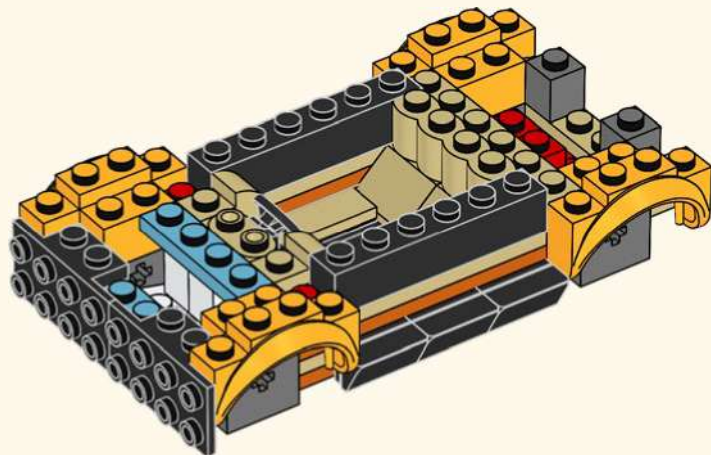



1x



1x



2x



2x

20

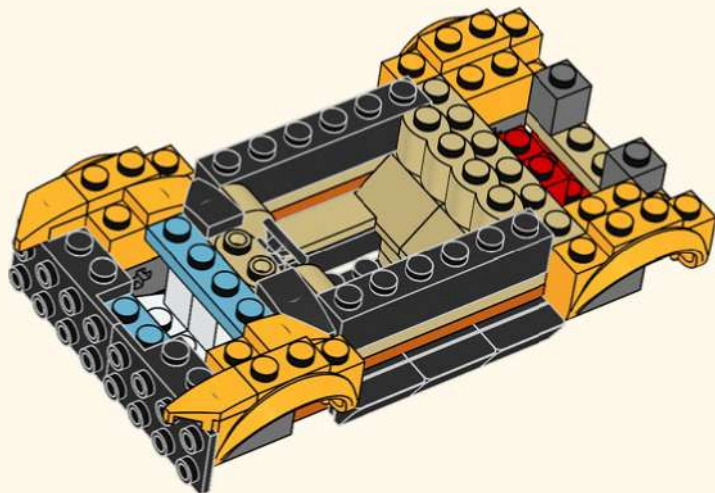









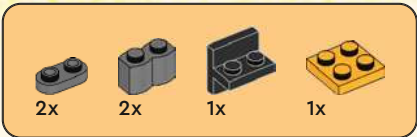

21

1

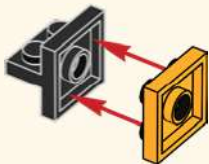

2

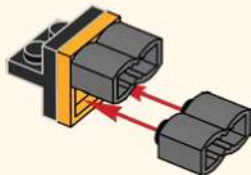

3

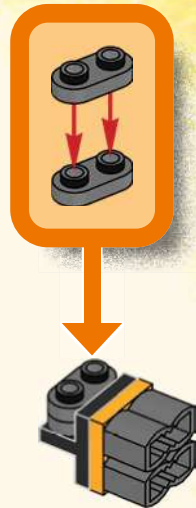

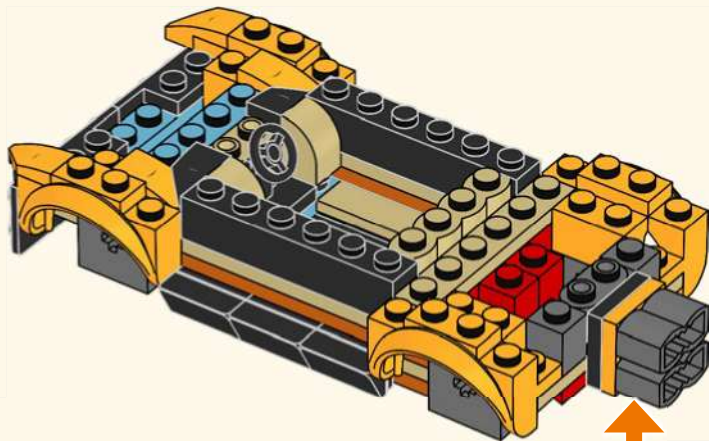

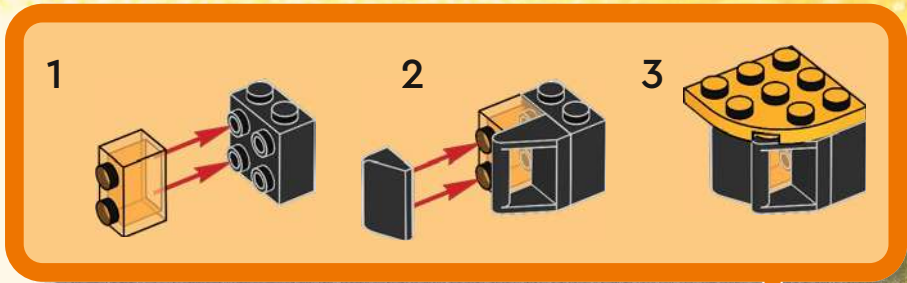
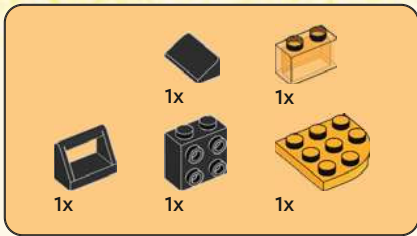

22

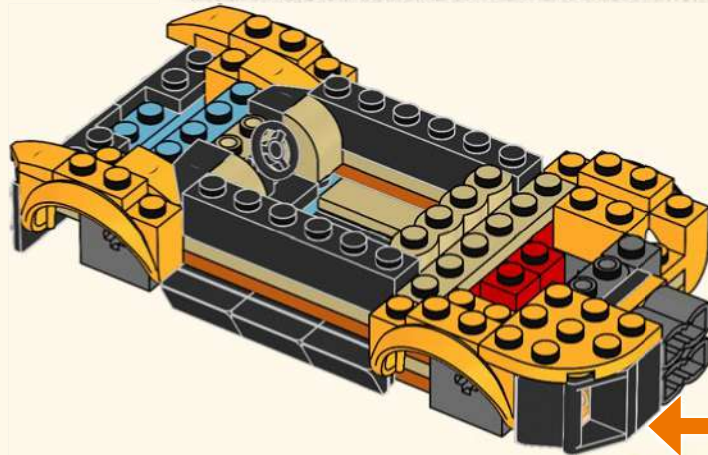



23

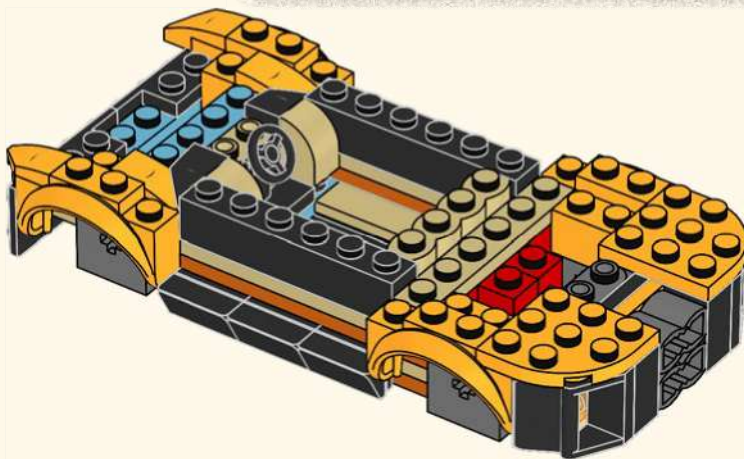
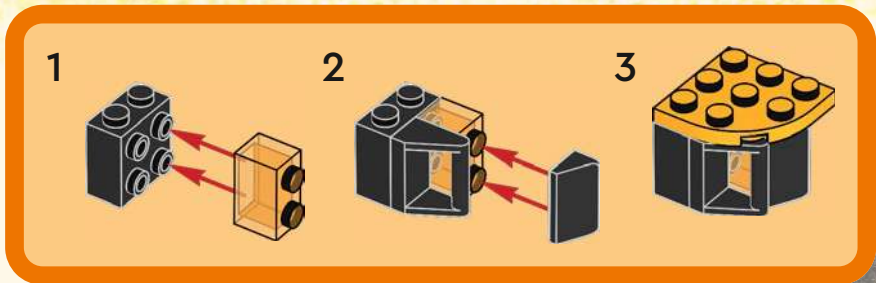





2x

24

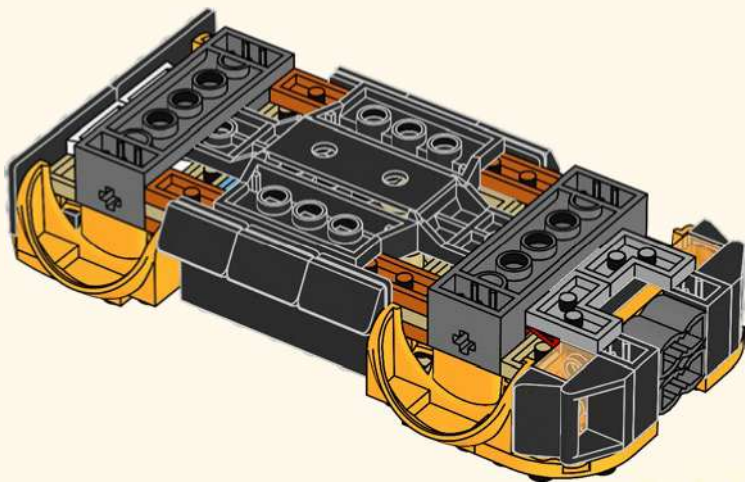



2x

25

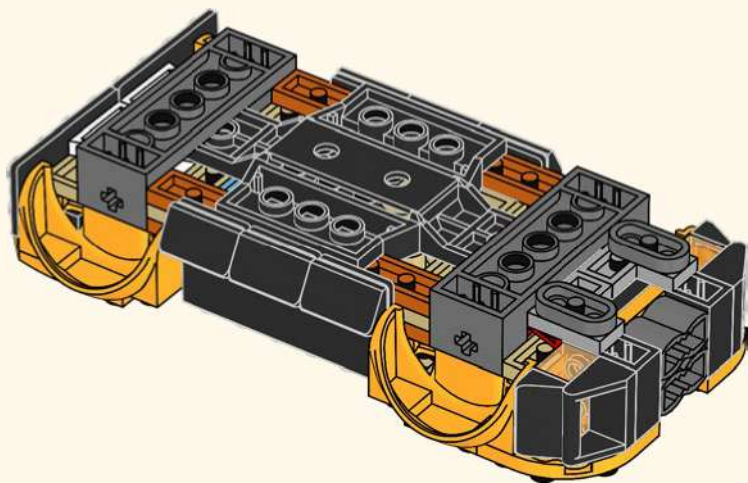



2x

26

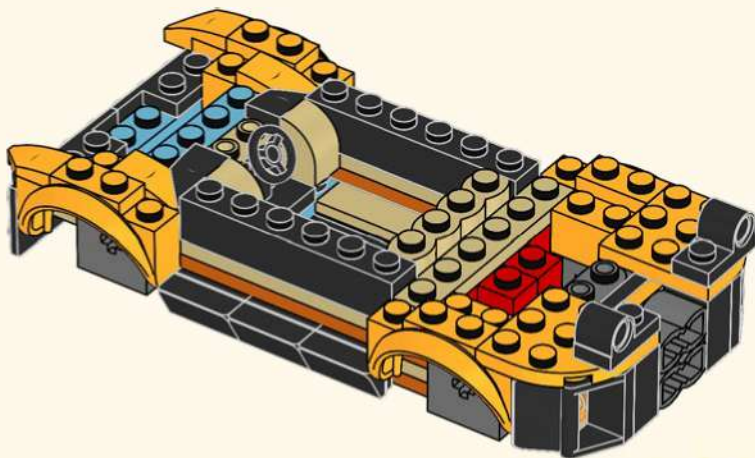



27

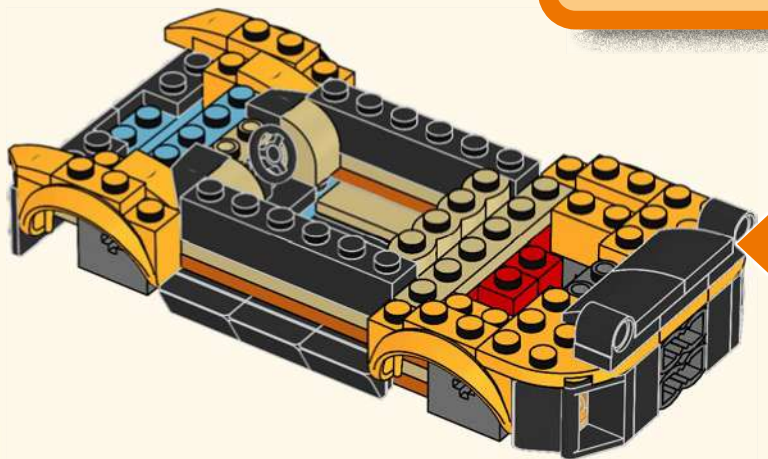
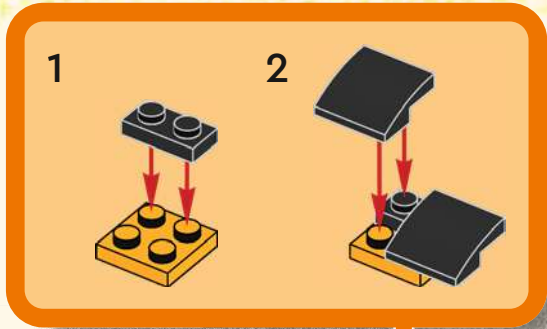



1x



2x

# 28

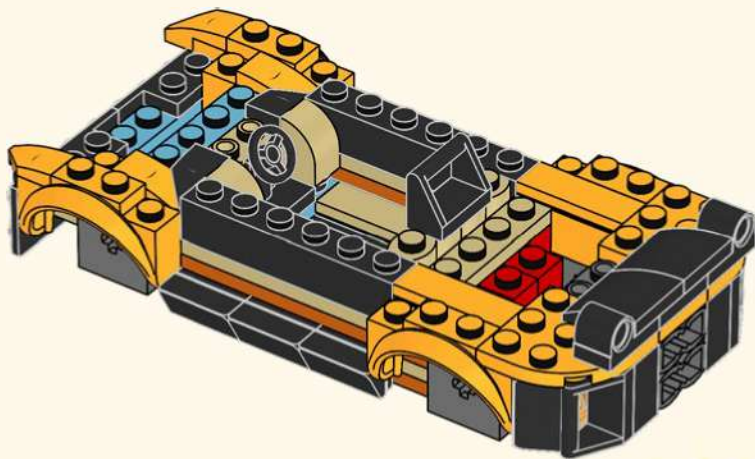



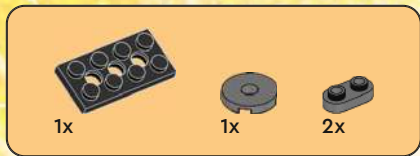

29

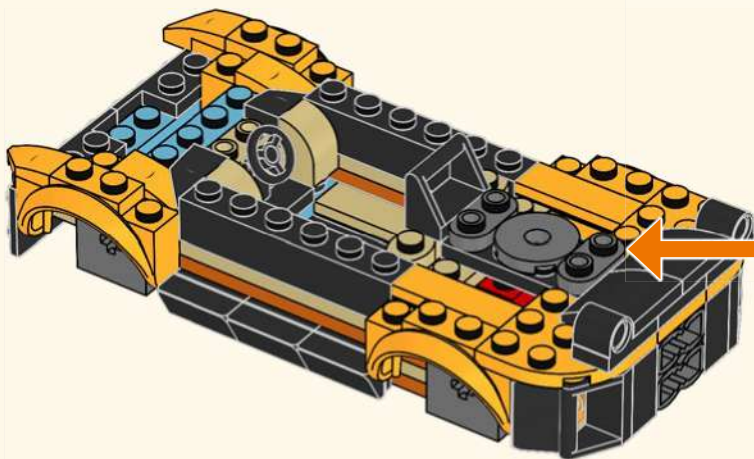
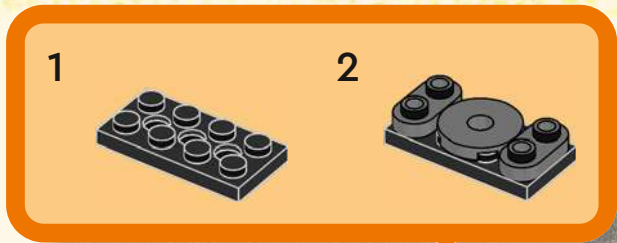

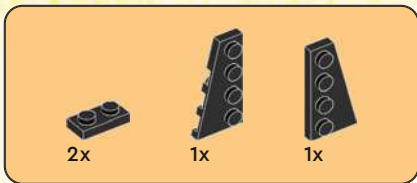

30

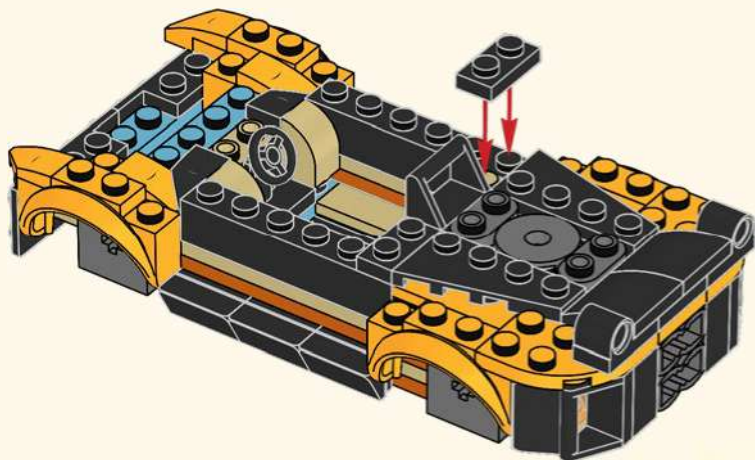

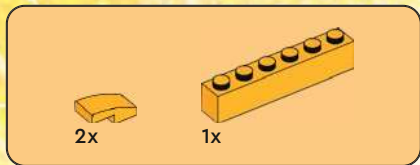

31

1

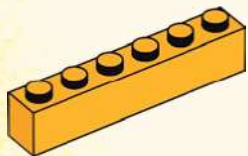

2

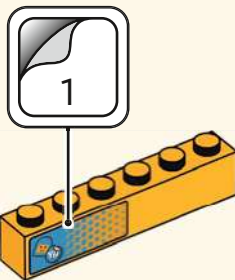

3

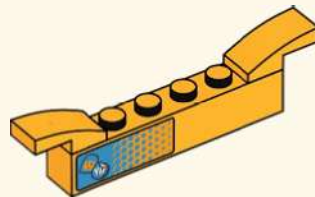

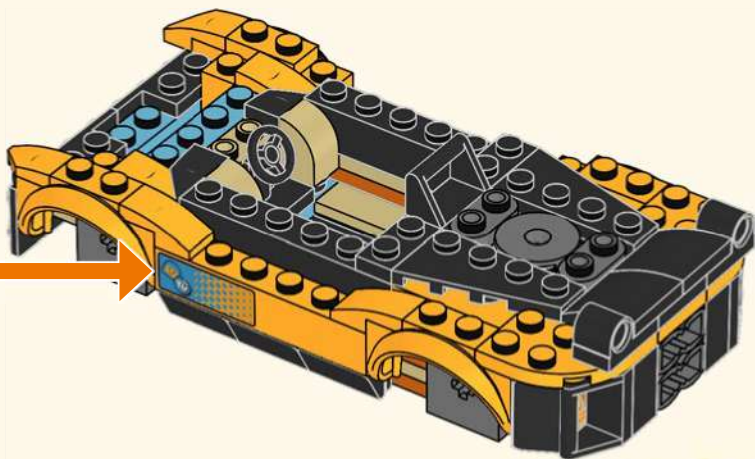

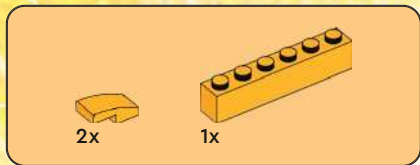

32

1

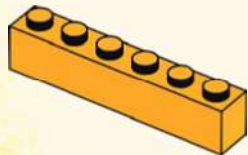

2

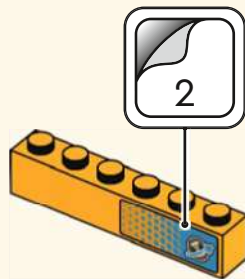

3

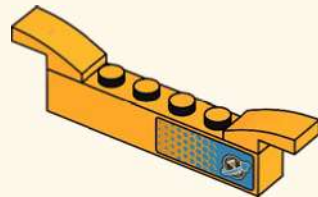



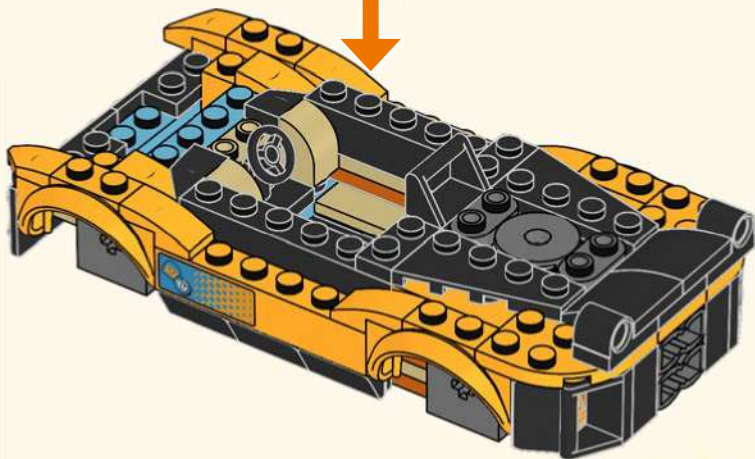



1x



1x

33

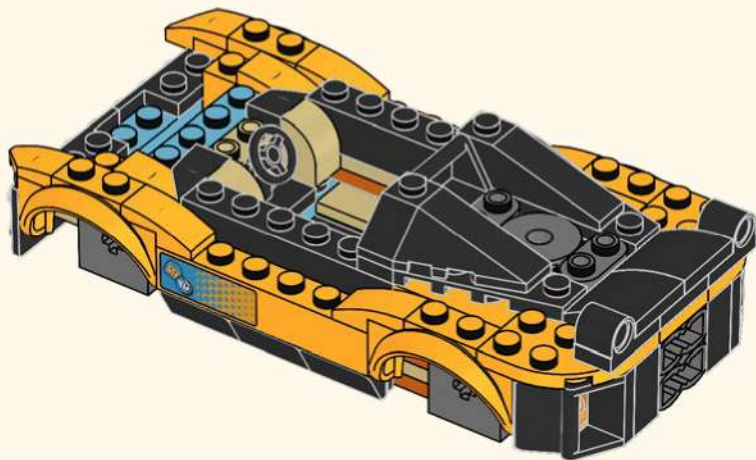



1x

34

1

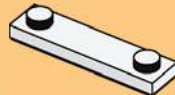

2

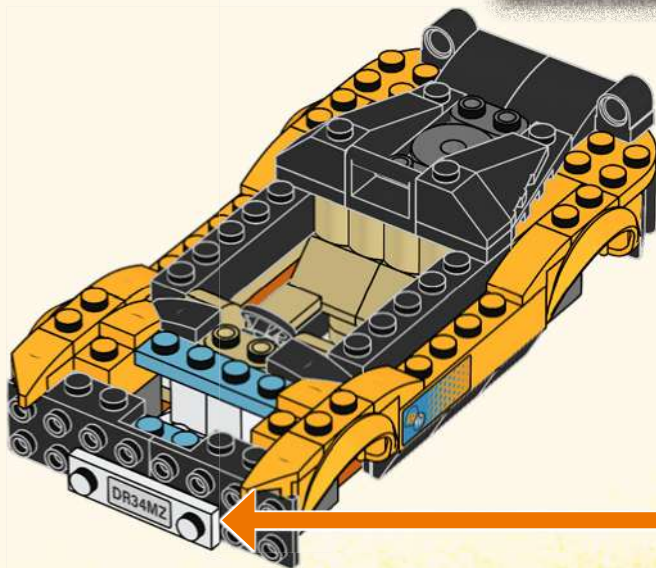
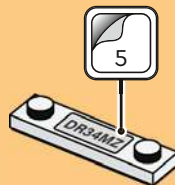

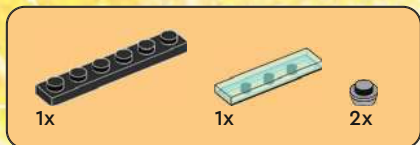

35

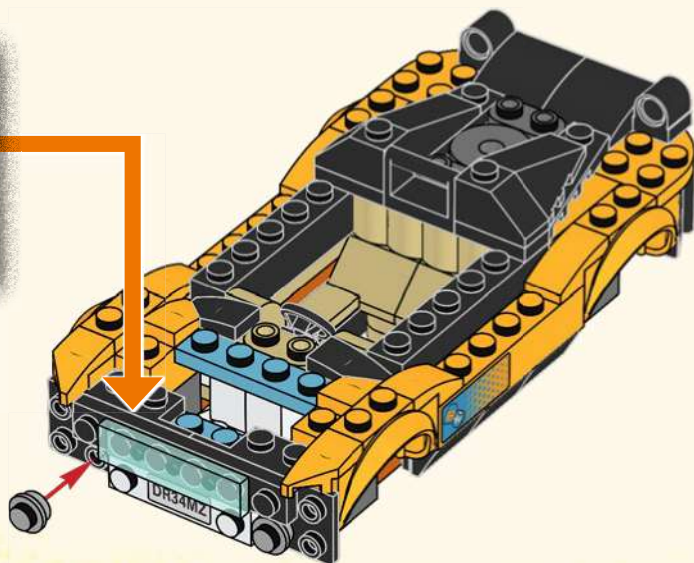
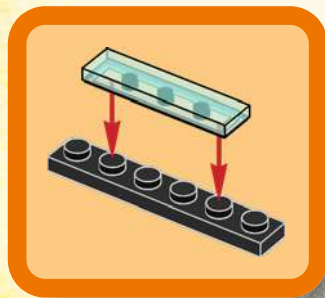



4x



2x

# 36

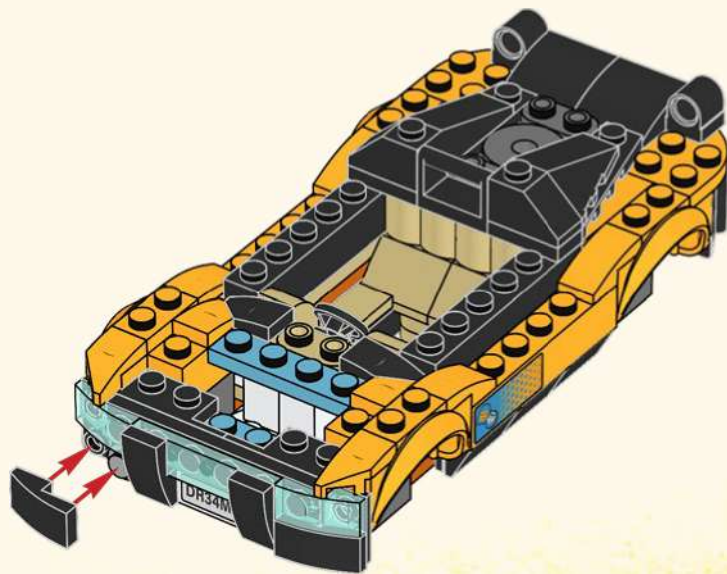





2x



2x

37

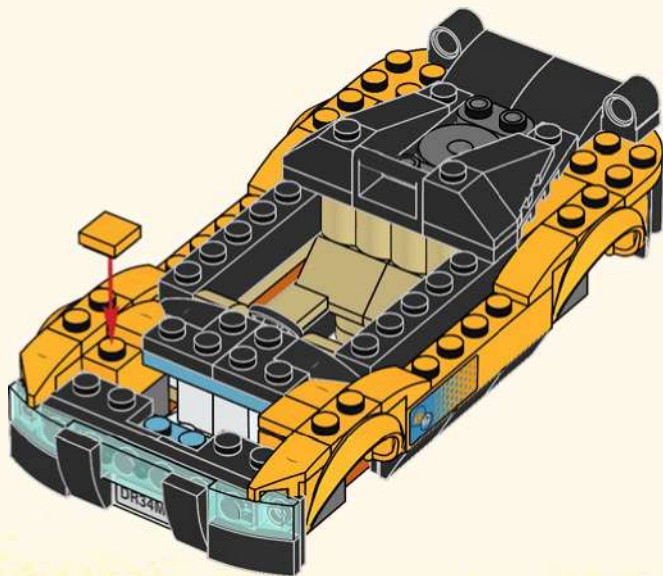



38

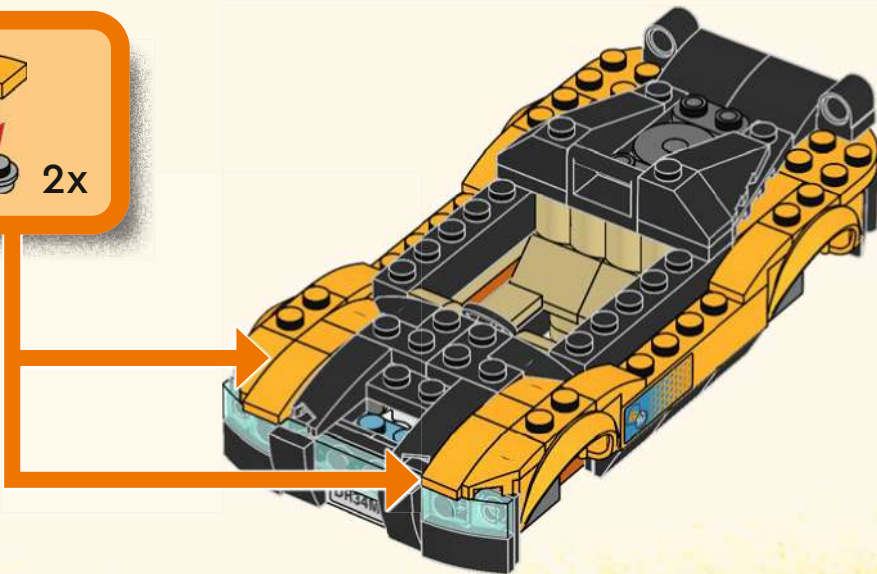



1x

39

1

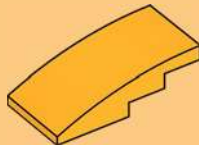

2

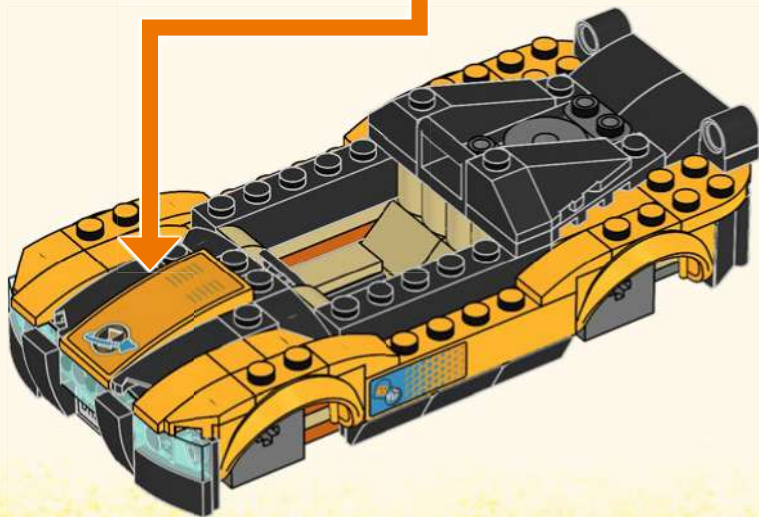

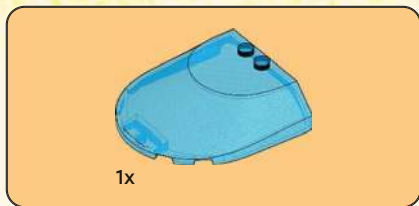

40

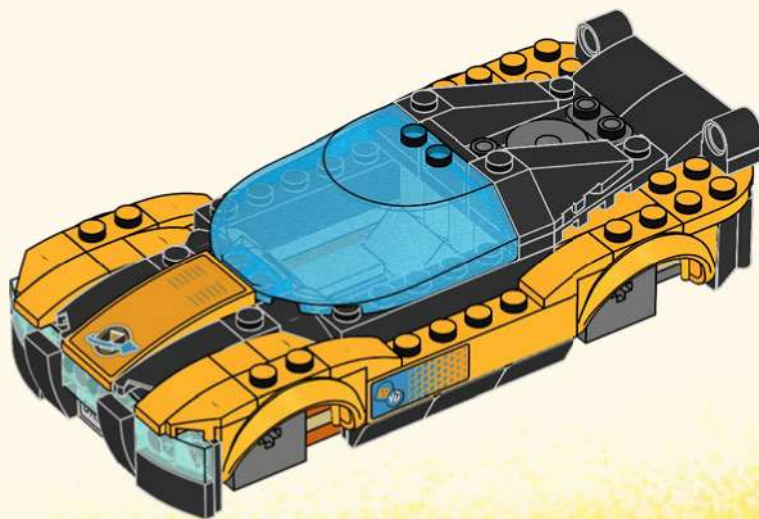



41

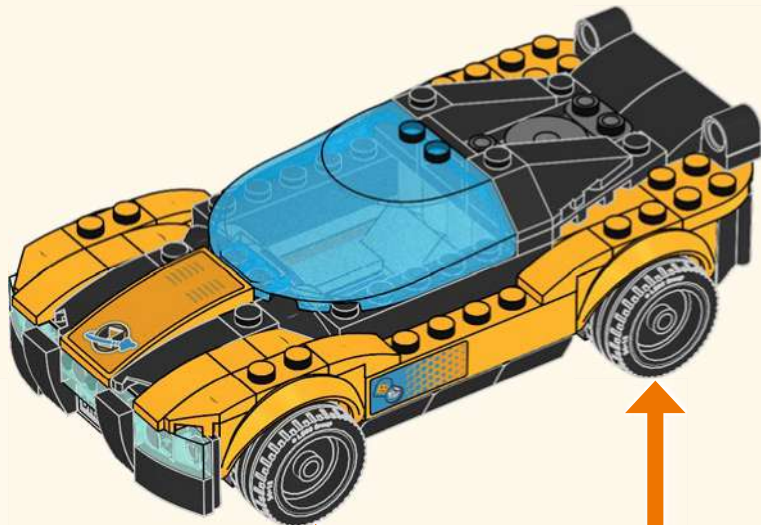
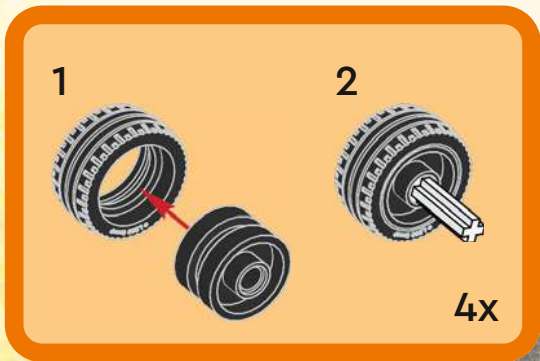





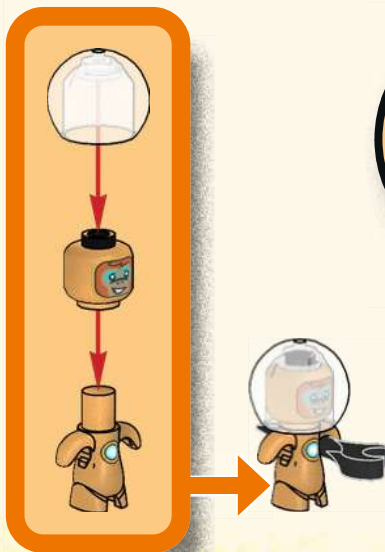

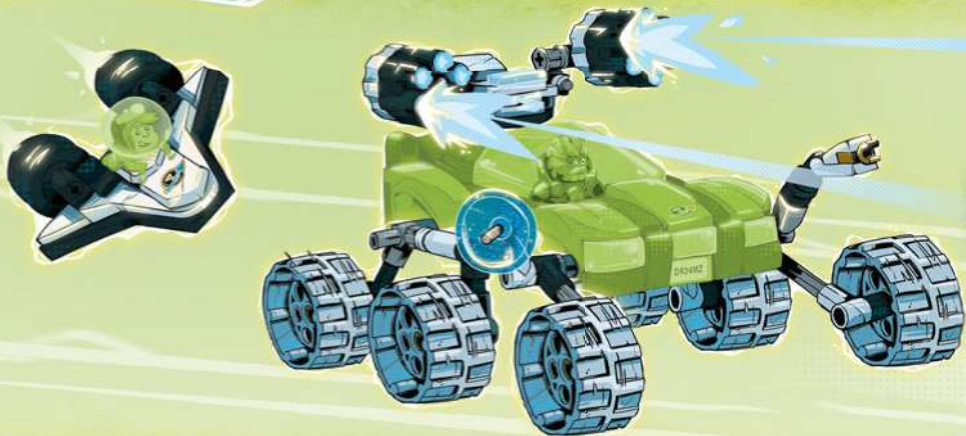
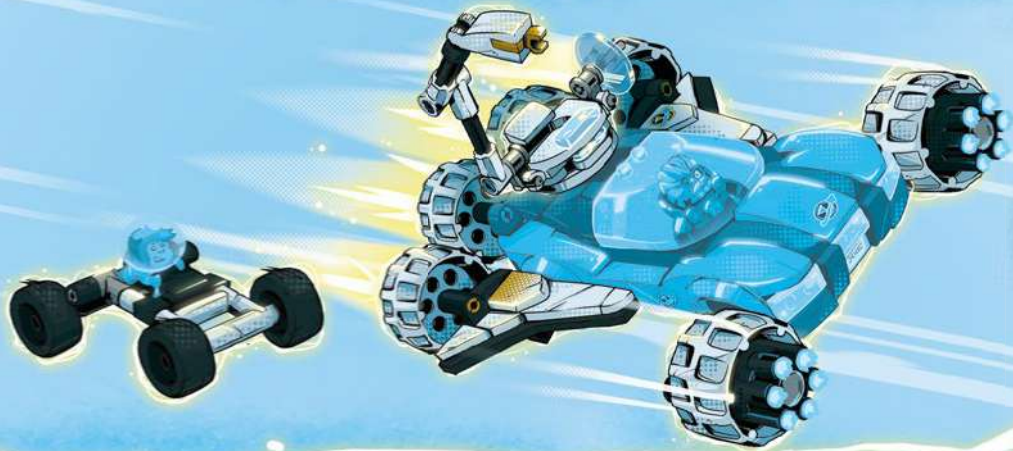



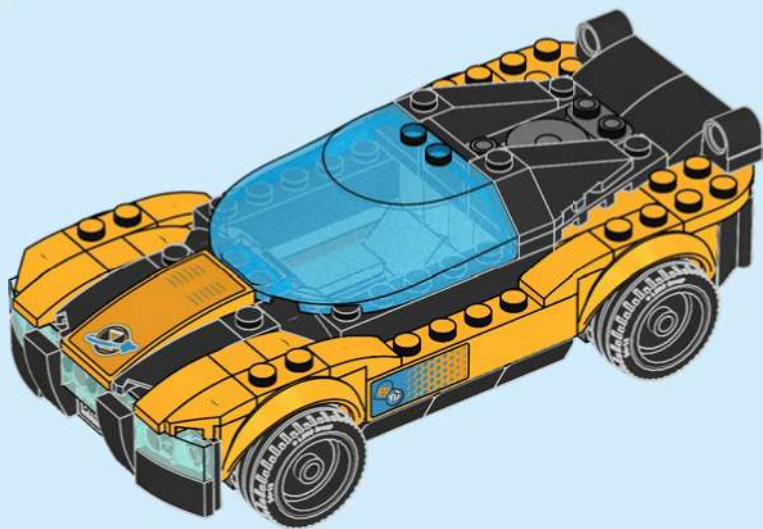

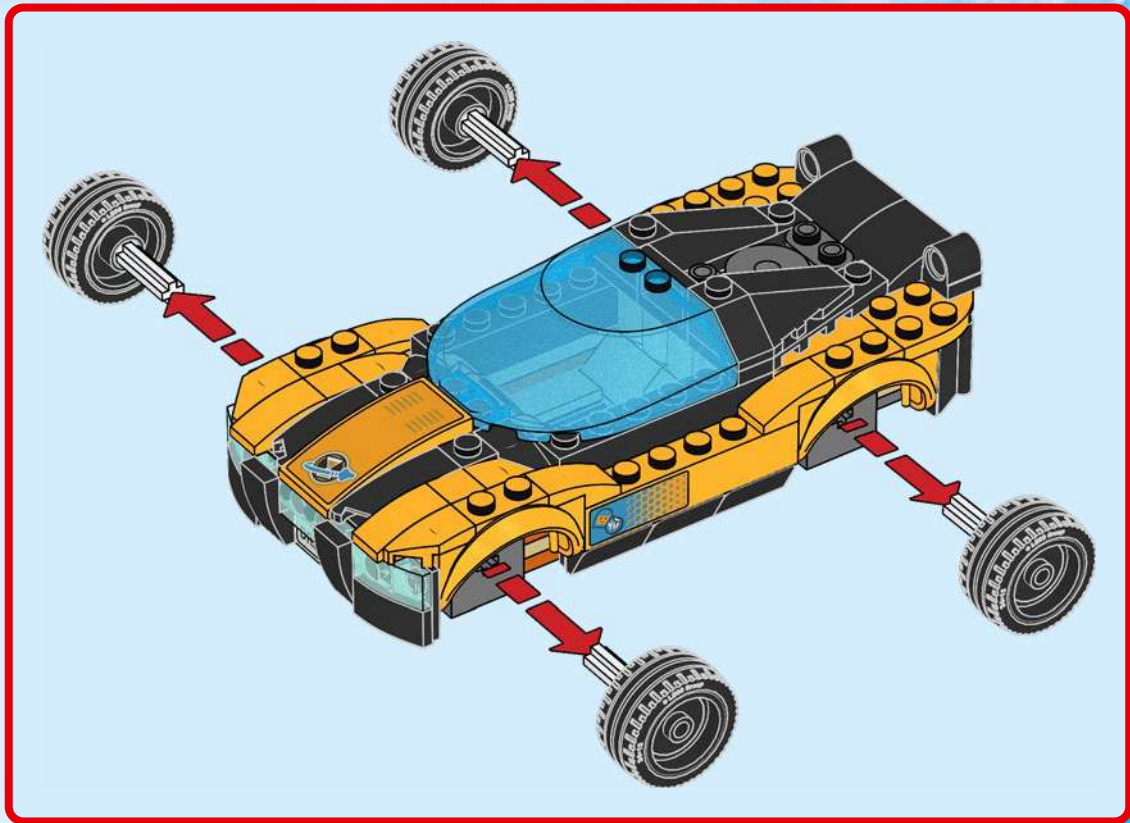



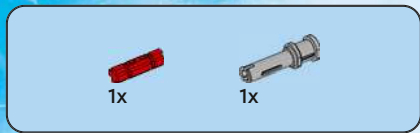

1

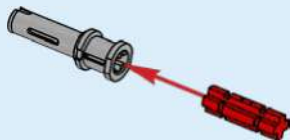

2

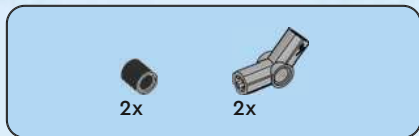

3

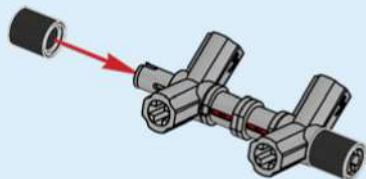



1x



1x

4

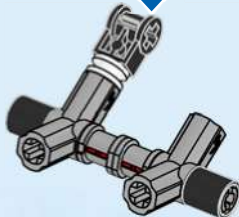
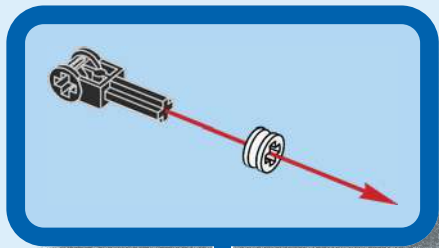

1x

5

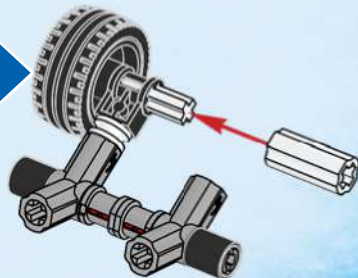



1x



1x

6

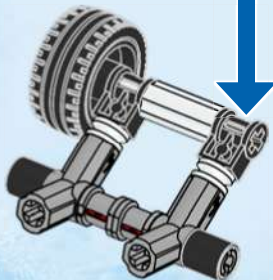
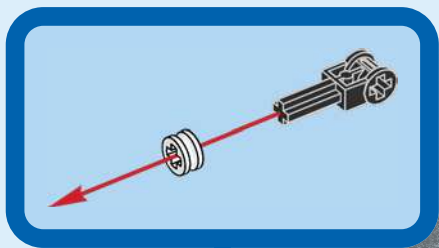

7

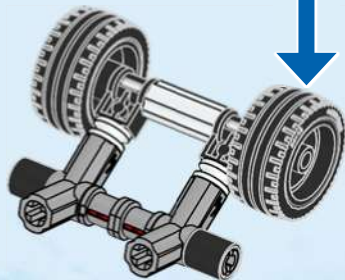

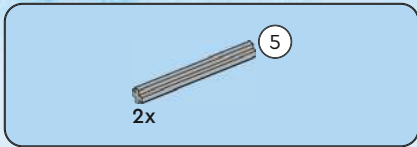

8

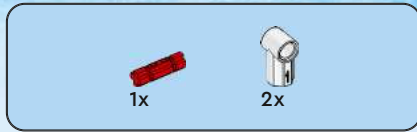
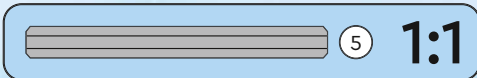
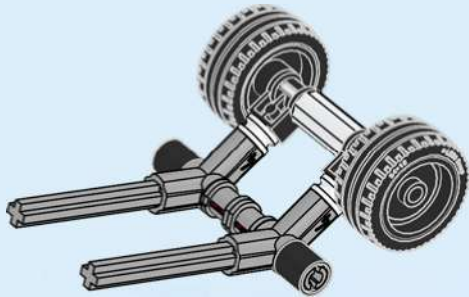

9

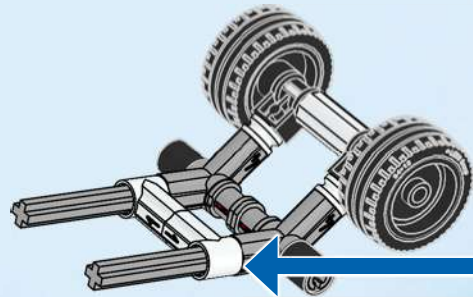
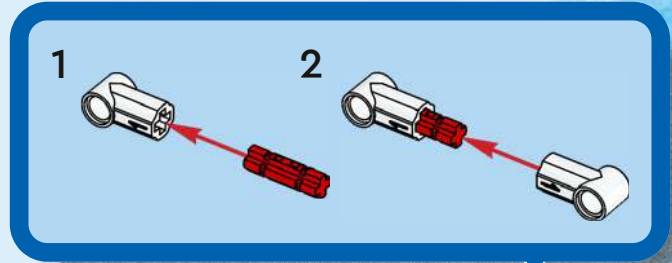



2x



1x



1x

# 10

1



2



3

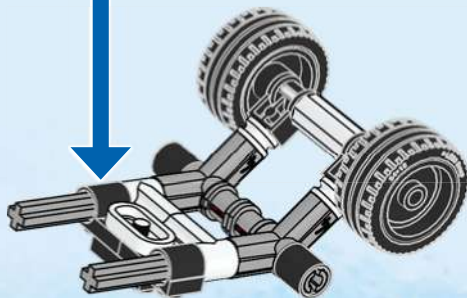
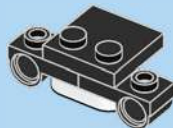





1x



2x

# 11

1

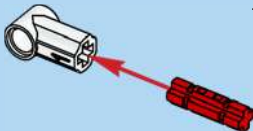

2

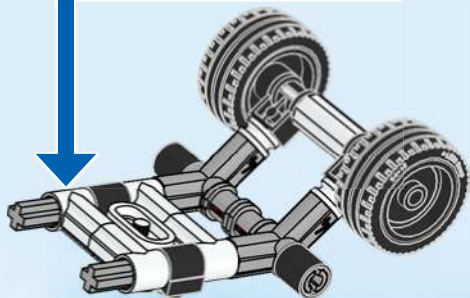
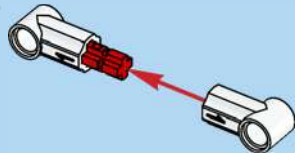

1x

# 12

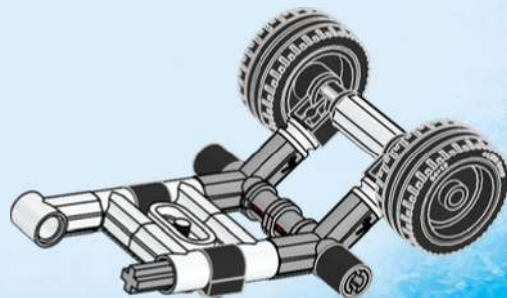



1x

13

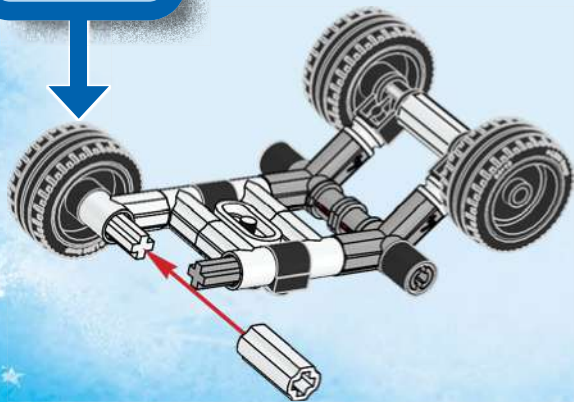

1x

14

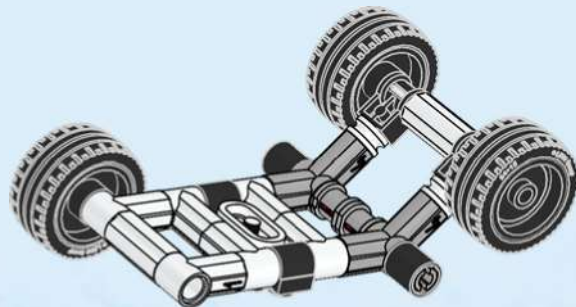

15

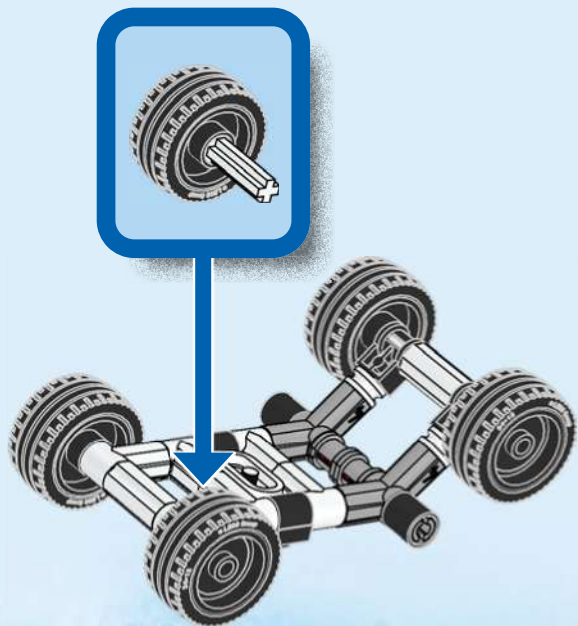

16

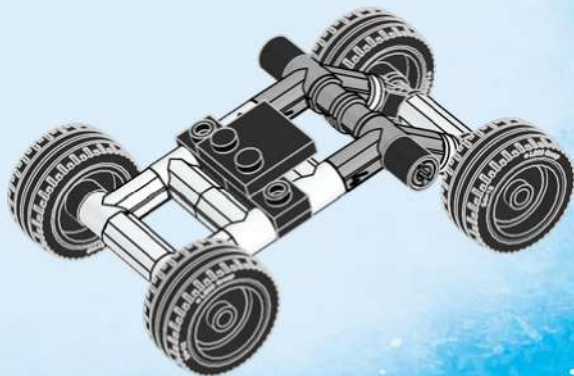

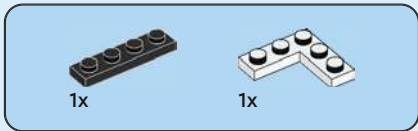
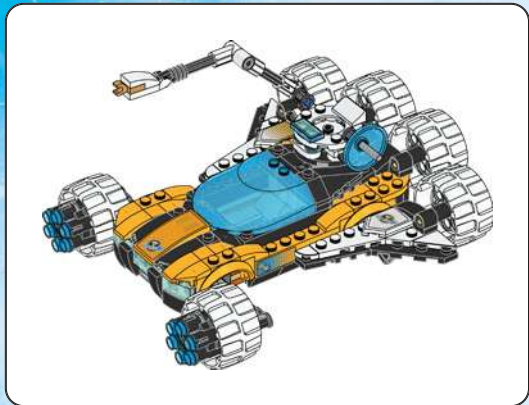

1

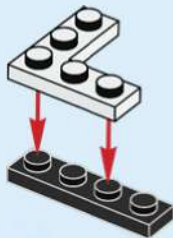



2

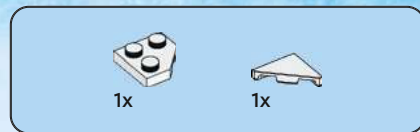

3





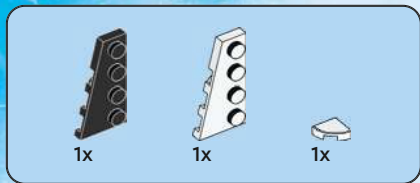

4

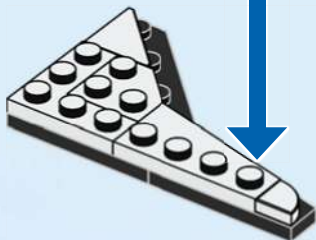
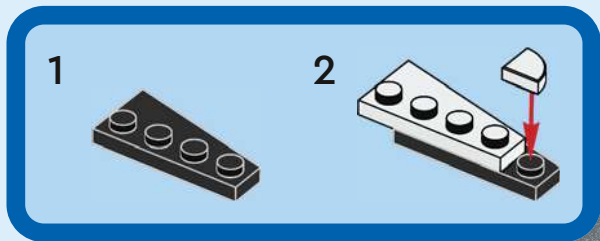

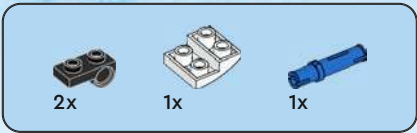

5

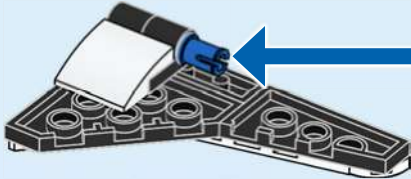
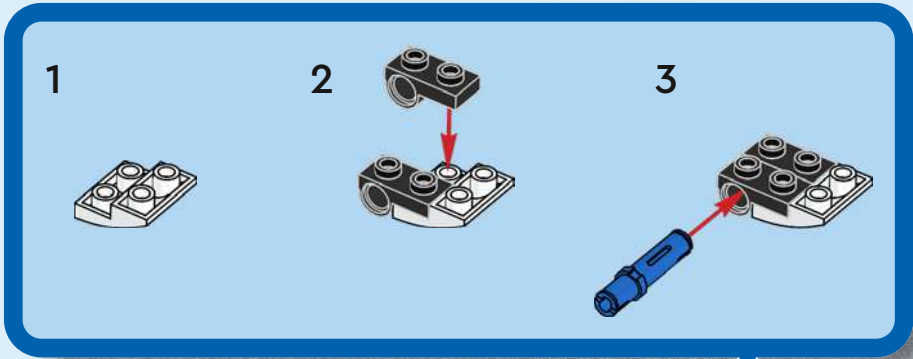



6

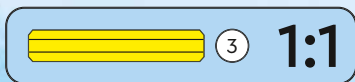
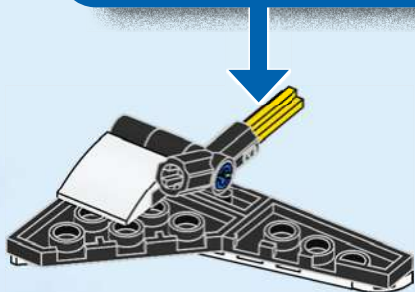
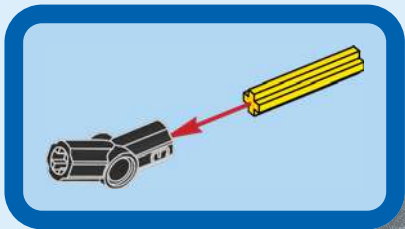

7

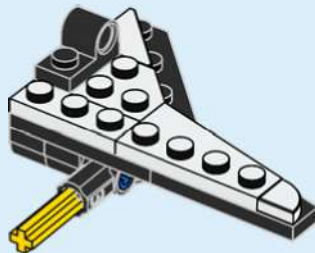



1x



1x

8

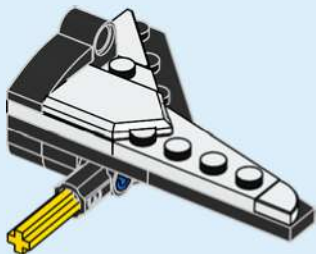

9



10

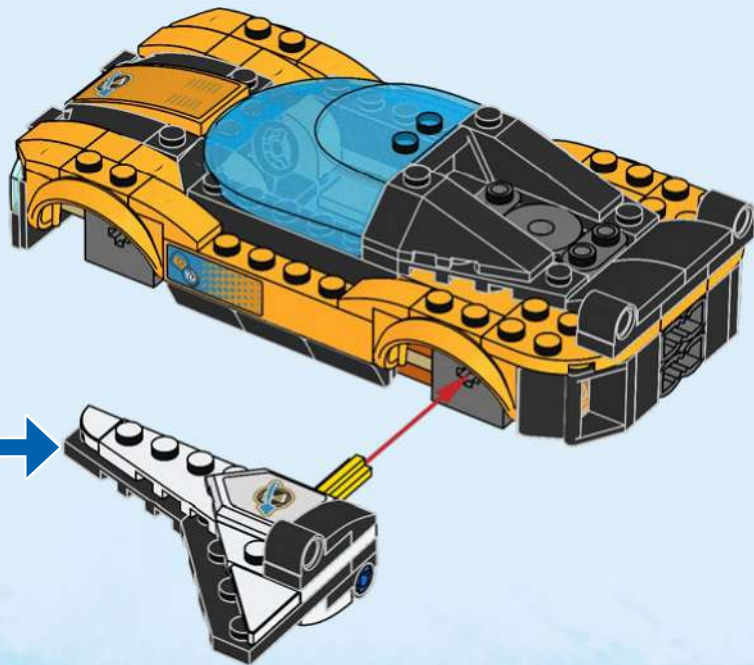



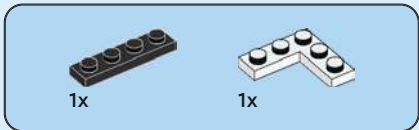

11

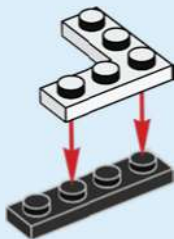

12





1x



1x

# 13



1x



1x



1x

# 14

1

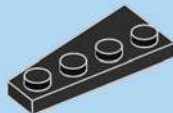

2

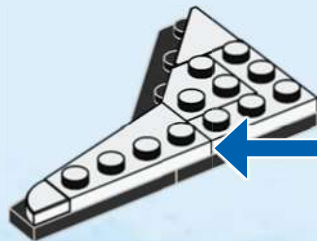

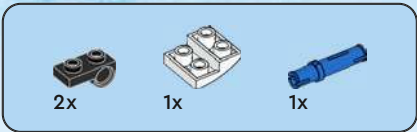

15

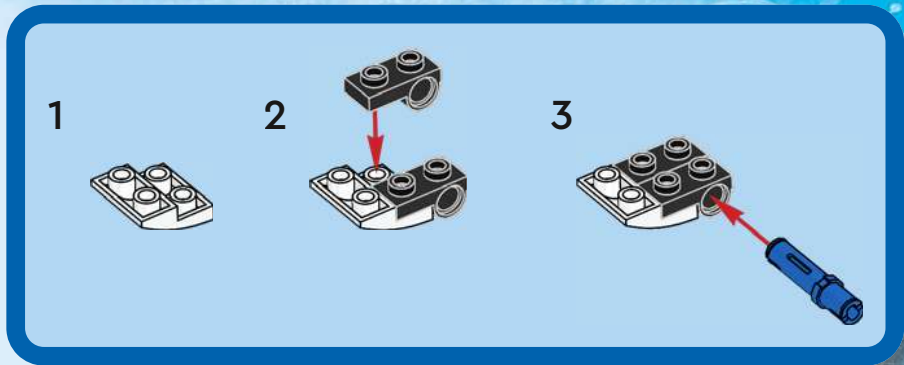



16

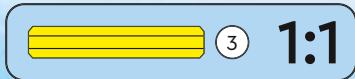
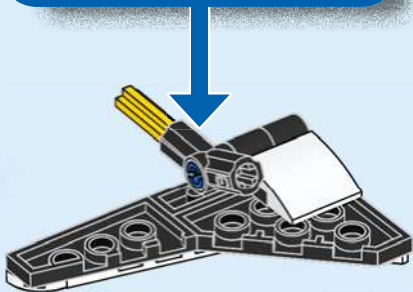
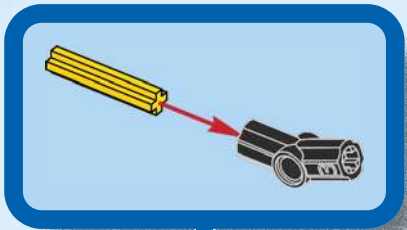

17

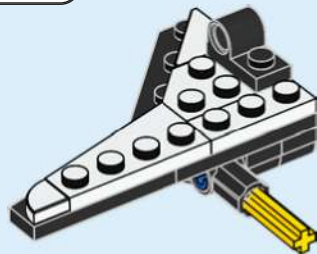



1x



1x

18

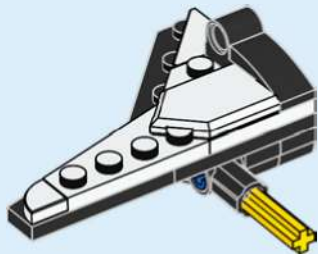

19

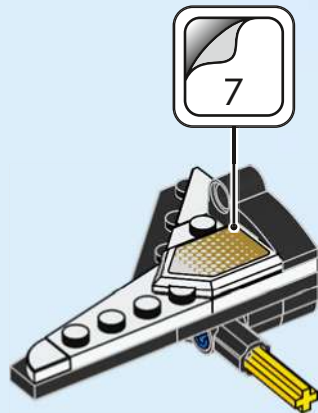



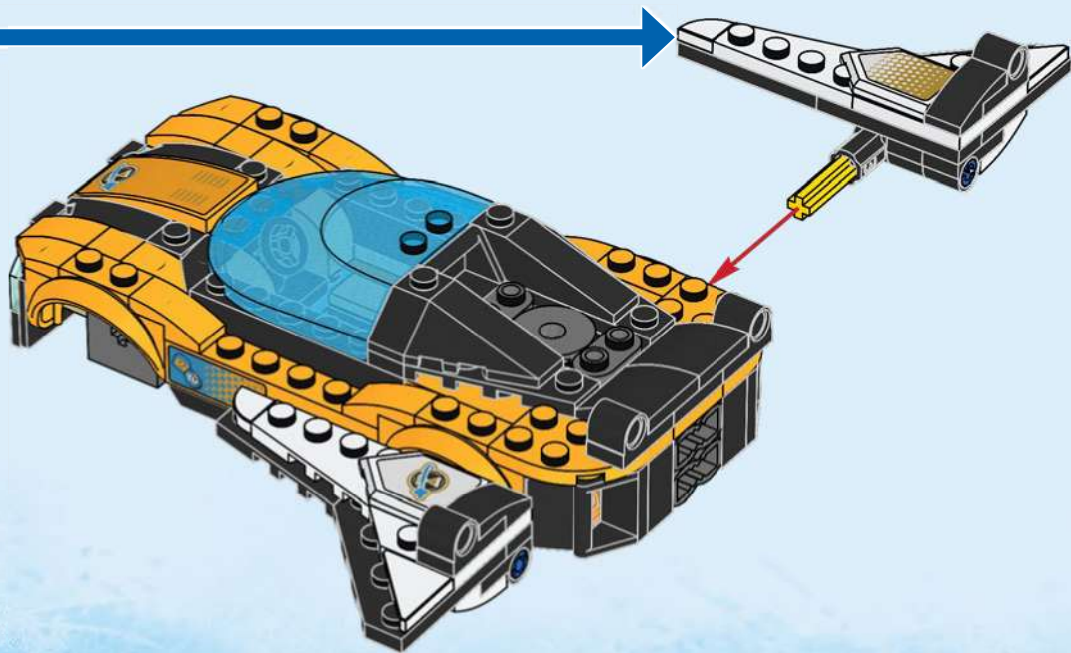

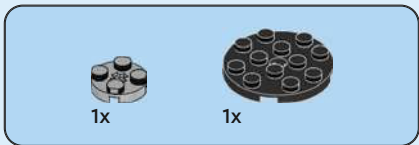

21

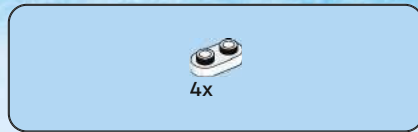
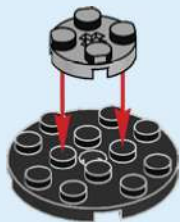

22

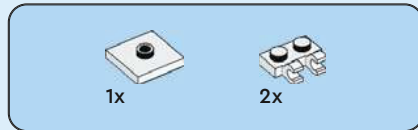

23





4x

24

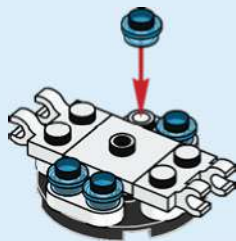

1x

25





1x



1x

# 26



# 27





1x

28

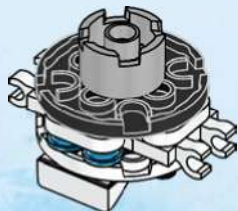

1x



1x



1x

29

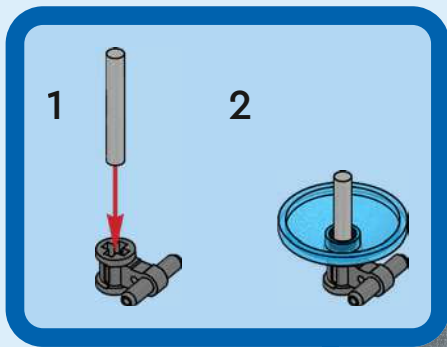





1x



1x

30

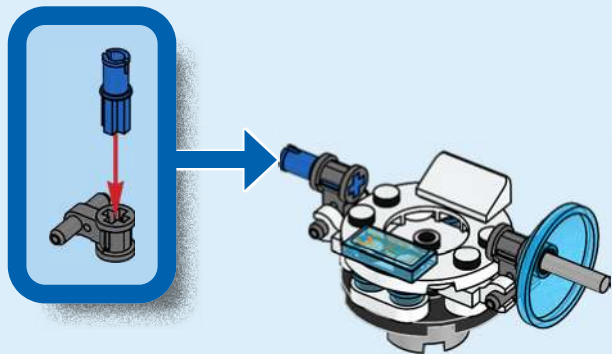

1x

31

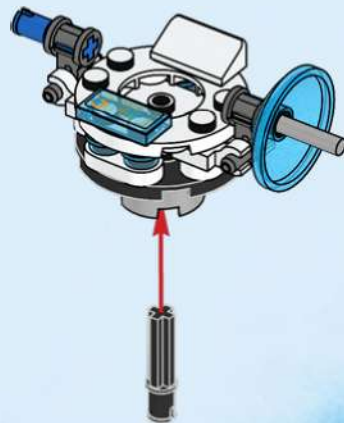

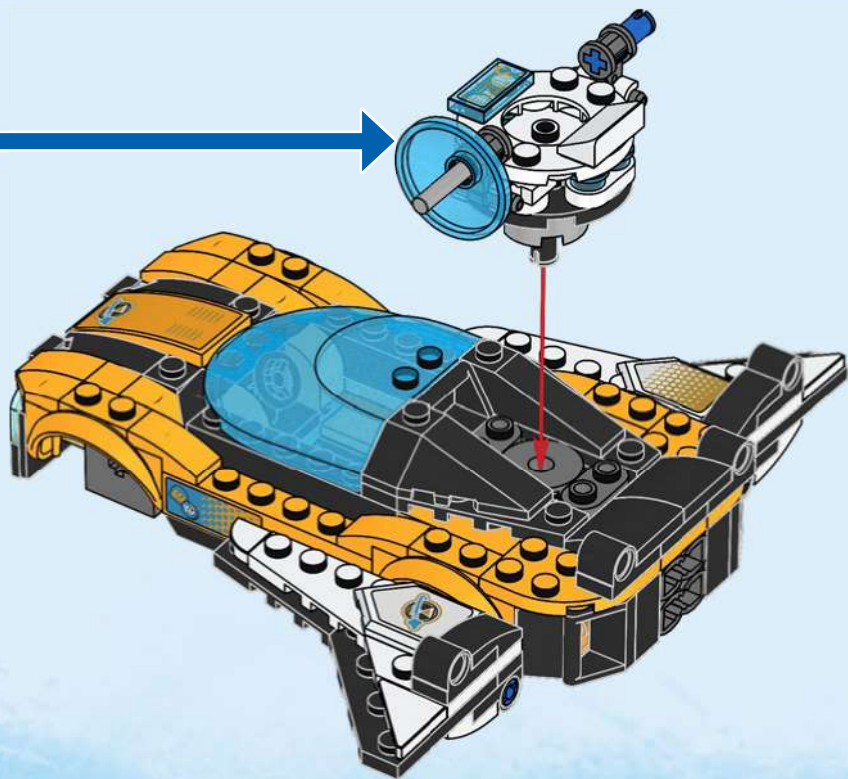



33

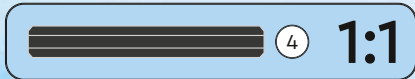

34

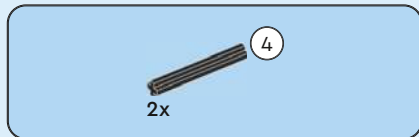

35





1x



1x

# 36

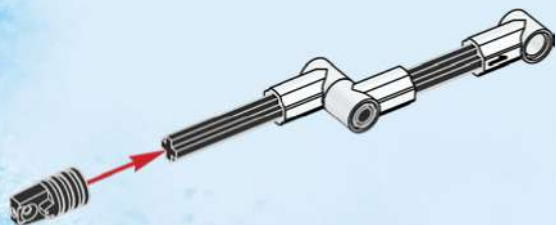

1x



1x



1x

# 37

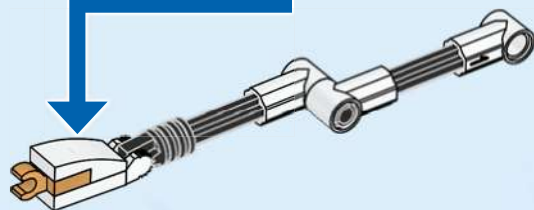
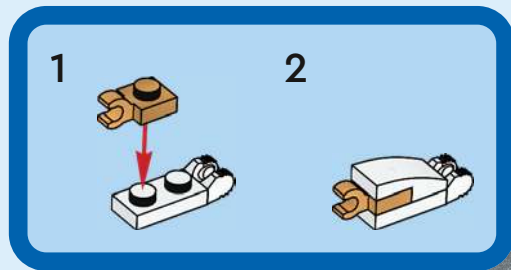

38

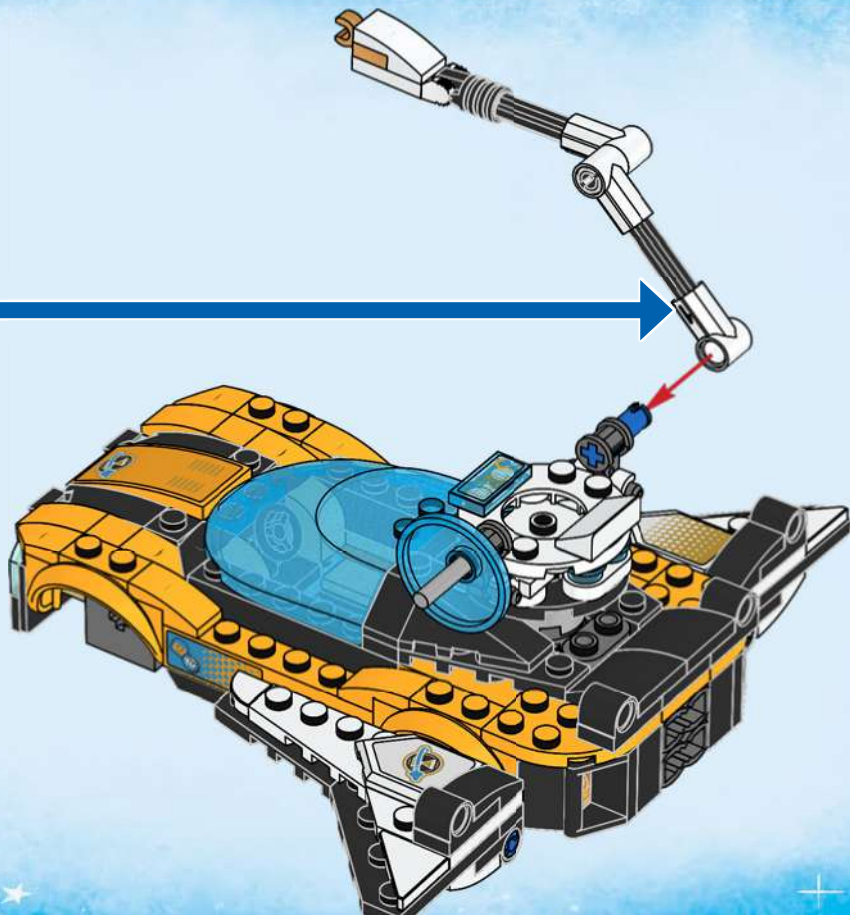





4x



4x



4x



4x



4x



4x

39

1

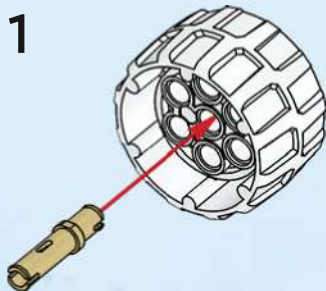

2

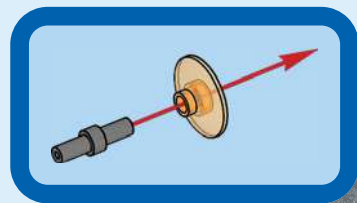

3

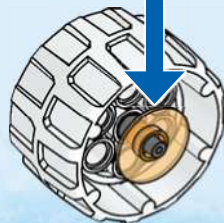

4x

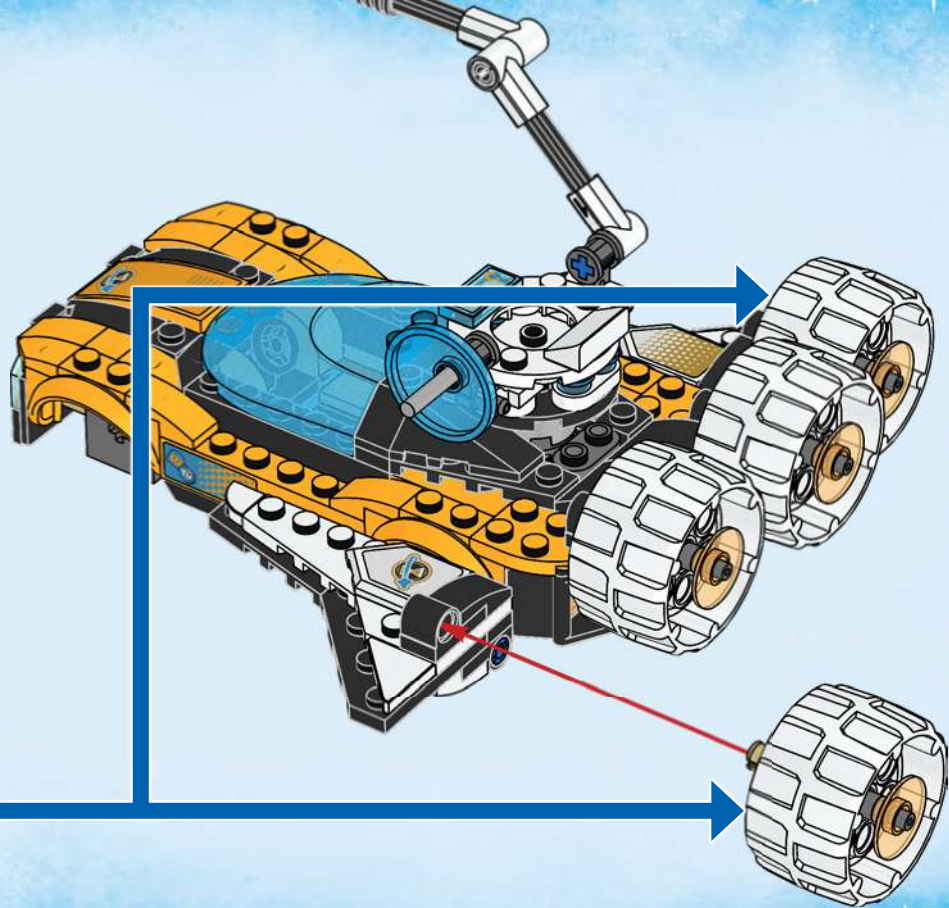



2x



1x



1x

40



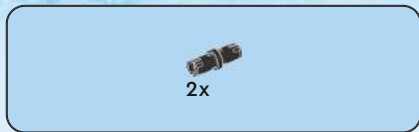

41

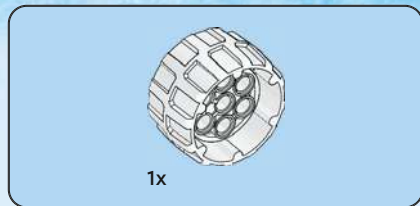
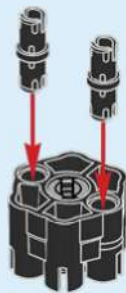

42

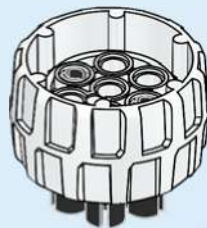

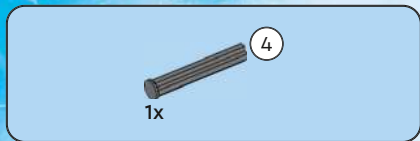

43

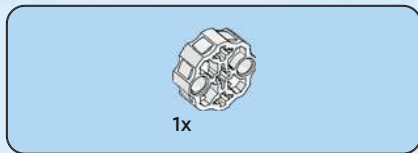
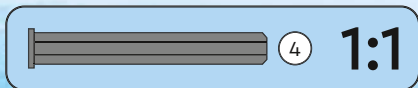

44

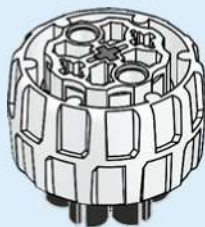



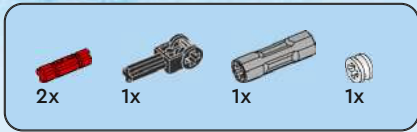

45

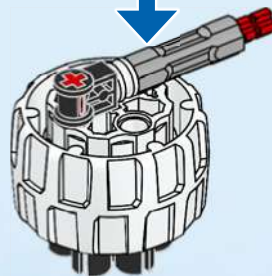
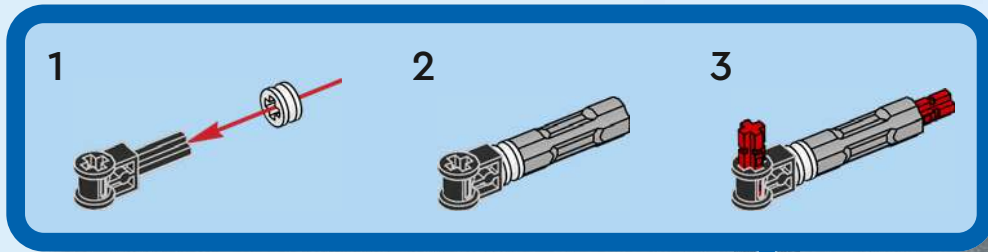

2x

46

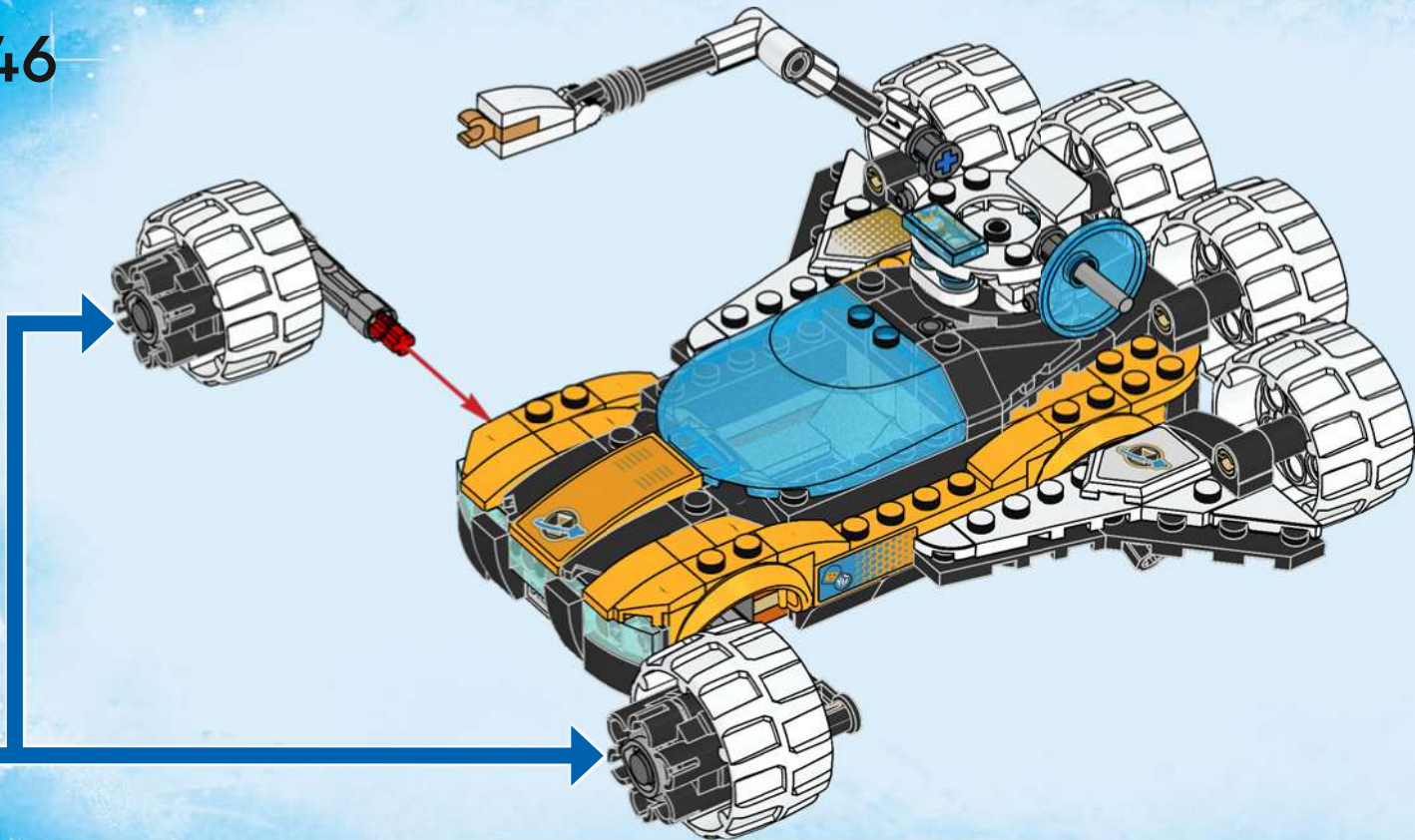

  
18x

47

