

# Kensington®

## SmartFit® Conform™ Back Rest

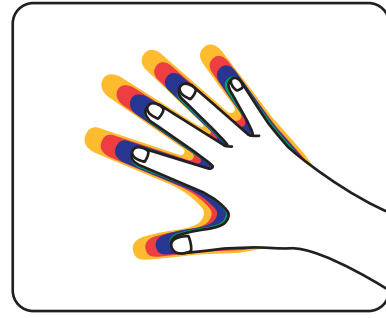

# 1

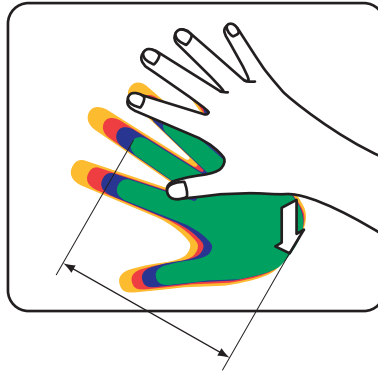

# 2

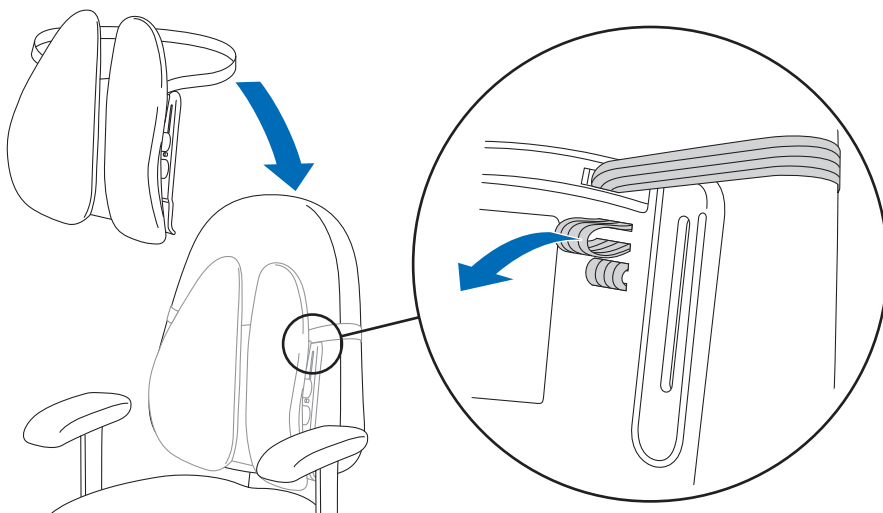
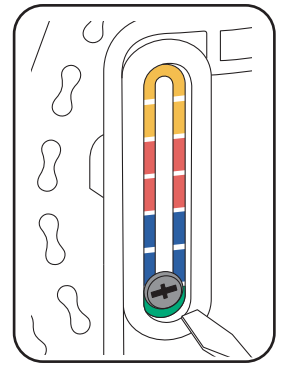
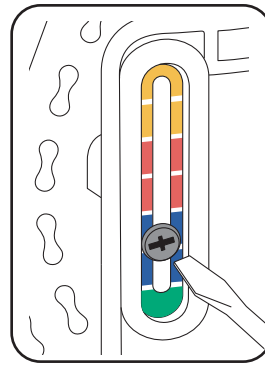
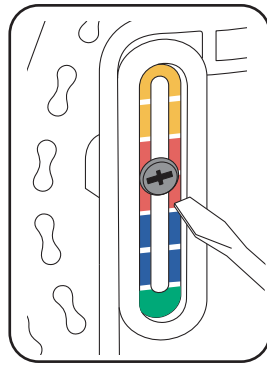
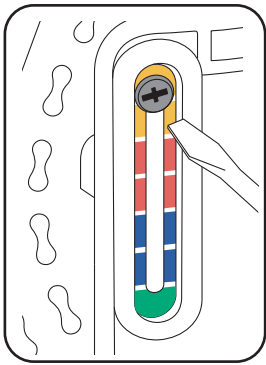

Kensington and the ACCO name and design are registered trademarks of ACCO Brands. SmartFit is a registered trademark of ACCO Brands. Conform is a trademark of ACCO Brands. All other registered and unregistered trademarks are the property of their respective owners.  
©2015 Kensington Computer Products Group, a division of ACCO Brands. Any unauthorized copying, duplicating, or other reproduction of the contents hereof is prohibited without written consent from Kensington Computer Products Group. All rights reserved. 08/15