

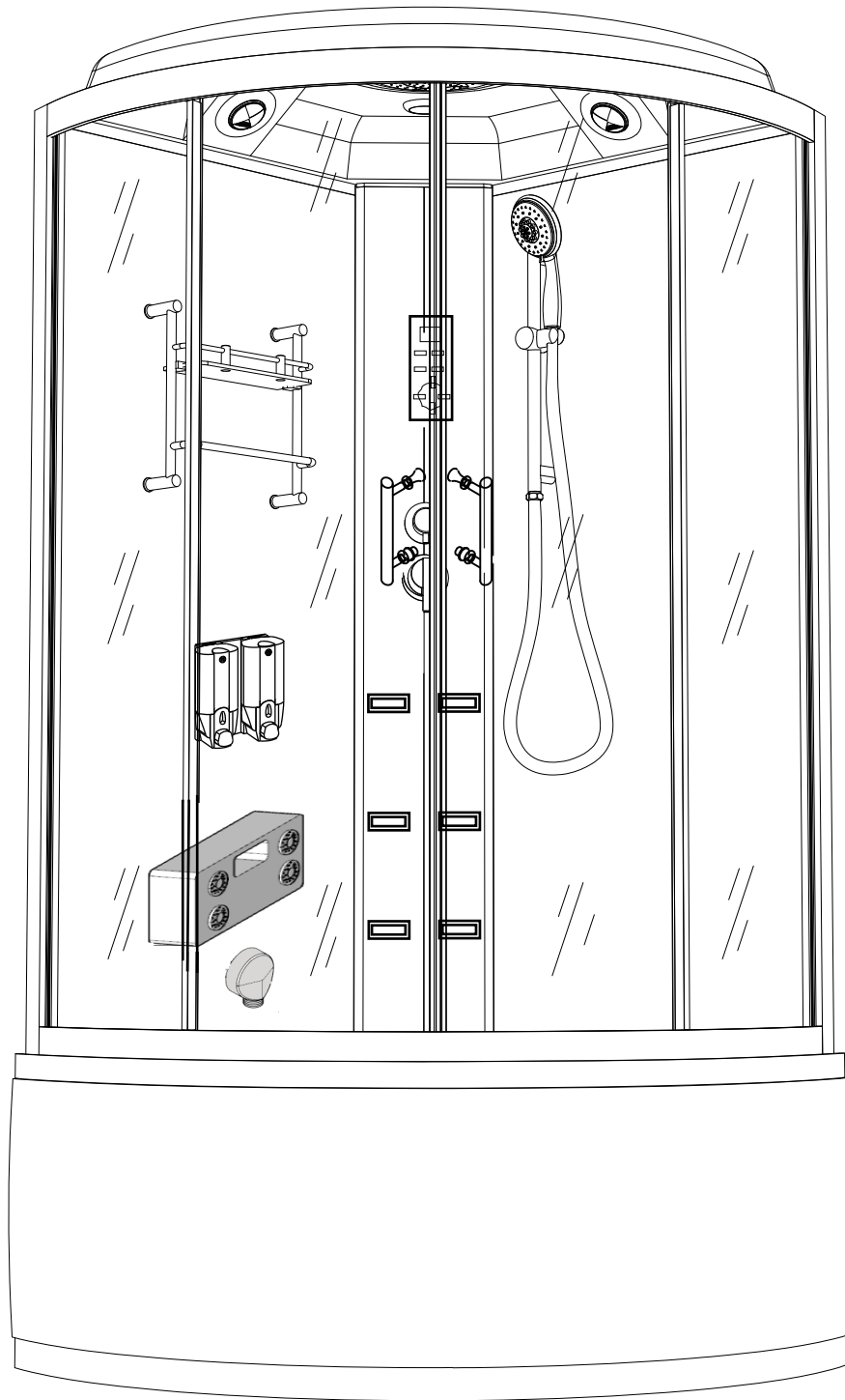

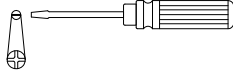

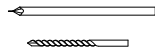

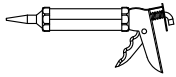

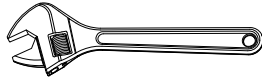

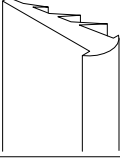

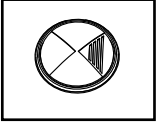

SN-8809S SN-8810S SN-8818S
SN-8135S SN-8135E

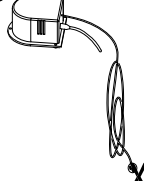

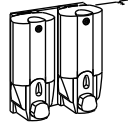
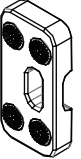
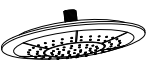
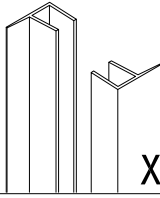
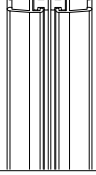
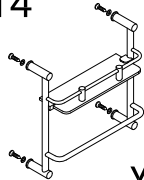
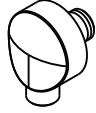
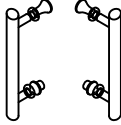
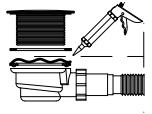
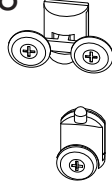

<p>A1</p>  <p>X1</p>	<p>A2</p>  <p>X2</p>	<p>A3</p>  <p>X1</p>	<p>A4</p>  <p>X1</p>	<p>A5</p>  <p>X1</p>
<p>A6</p>  <p>X2</p>	<p>A7</p>  <p>L=1.5M X1</p>	<p>A8</p>  <p>X1</p>	<p>A9</p>   <p>X4</p>	<p>A10</p>  <p>X1</p>
<p>A11</p>  <p>X1</p>	<p>A12</p>  <p>X2</p>	<p>A13</p> 	<p>A14</p>  <p>X1</p>	<p>A15</p>  <p>X1</p>
<p>A16</p>  <p>X2</p>	<p>A17</p> 	<p>A18</p> 		
 <p>ST4X40=8</p>	 <p>ST4X10=44</p>	 <p>ST4X35=2</p>	 <p>ST4X12=4</p>	

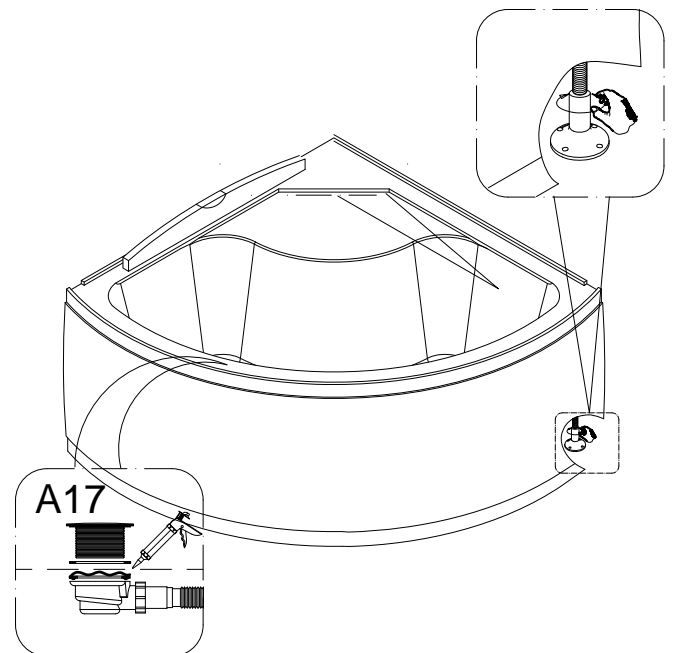
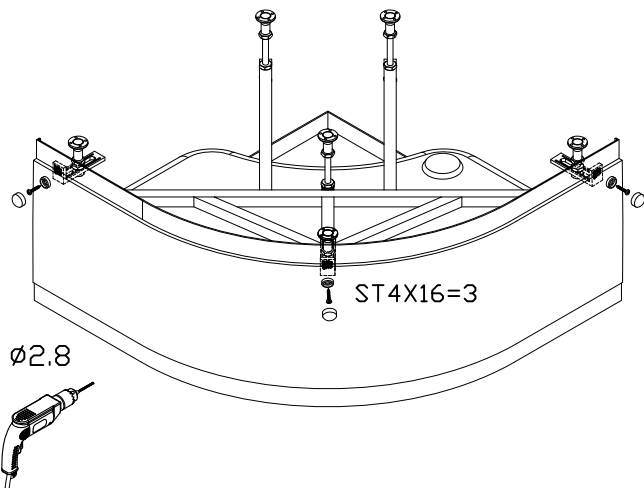
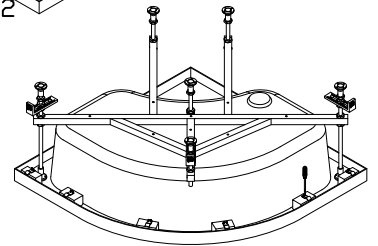
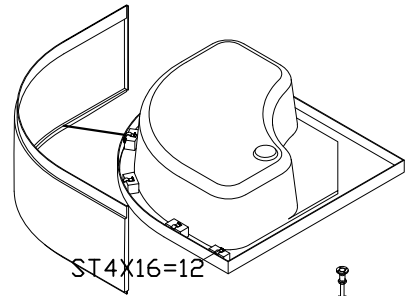
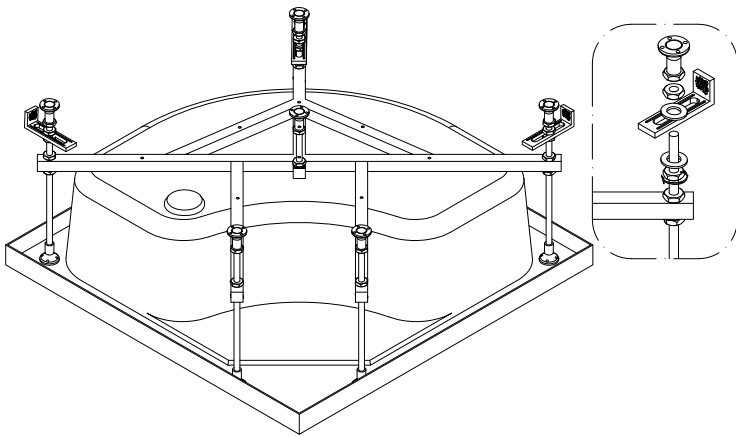
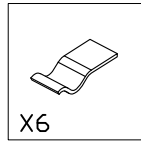
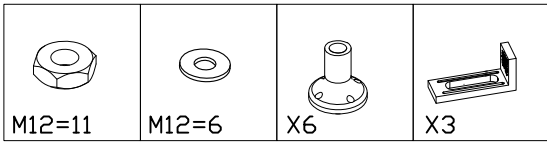
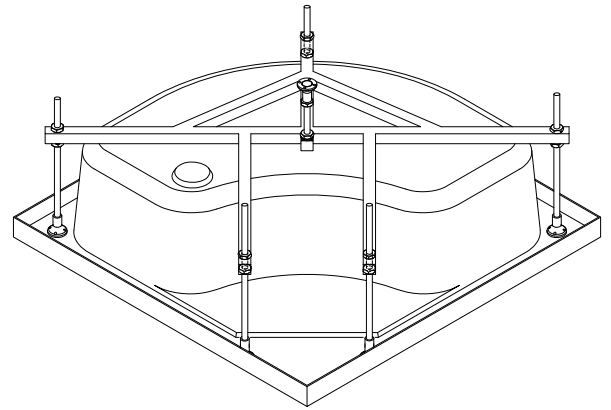
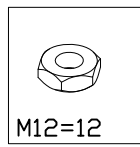
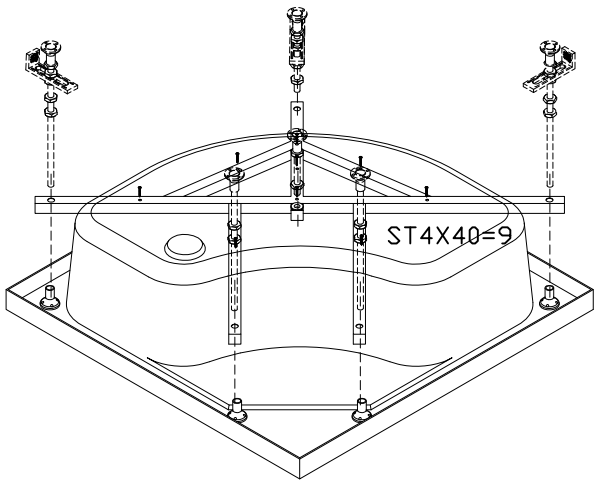

∅2.8

