

Schneider
Electric

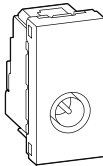

NU-461..
NU-470..

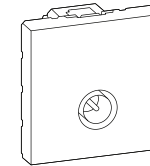

NU-462..
NU-463..
NU-464..

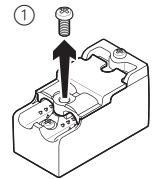
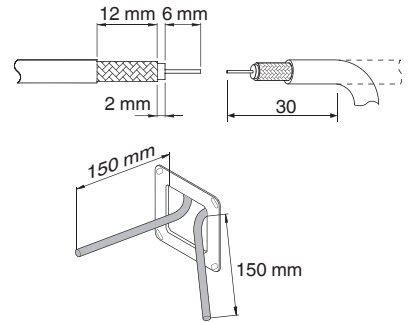

①

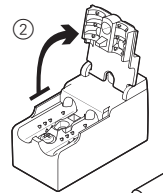

②

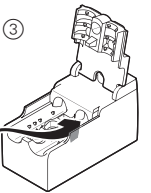

③

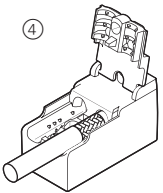

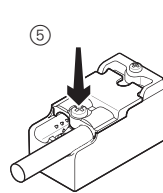

④

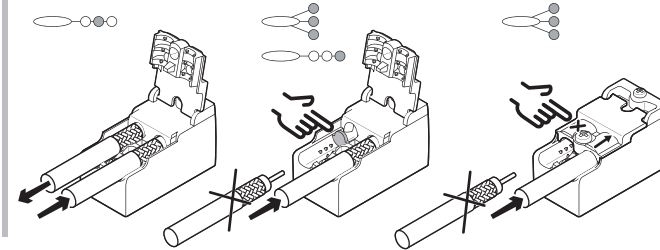

⑤

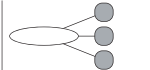
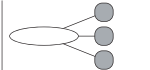

Art. no. Réf. Ref. арт. №		Ports Ports Puertos Порты	Frequency (MHz) Fréquence (MHz) Frecuencia (MHz) Частота (МГц)				Insertion loss (dB) Perte d'insertion (dB) Pérdida de inserción (dB) Вносимые потери (дБ)				Isolation (dB) Isolation (dB) Aislamiento (dB) Изоляция (дБ)		Return loss (dB) Facteur d'adaptation (dB) Factor de adaptación (dB) Обратные потери (дБ)					DC / 22 kHz pass (V/mA) Passage 22 kHz/DC (V/mA) Paso DC / 22 kHz (V/mA) Переход DC/22 кГц (В/мА)	Impedance Impédance Impedancia Импеданс	Operating temperature Température de fonctionnement Temperatura de servicio Рабочая температура
			IN-OUT	IN-TV	IN-R	IN-SAT	IN-OUT	IN-TV	IN-R	IN-SAT	FM <-> TV	SAT <-> TV	IN	OUT	TV	R	SAT	SAT		
NU-461.. NU-462.. NU-470..		SAT IEC m	-	-	-	DC-2200	-	-	-	< 1,5	-	-	>12	-	>12	>12	>12	50 V/500 mA	75 Ω	-25 °C ... + 55°C
NU-463..		SAT IEC m	47-2200	-	-	47-2200	< 2	-	-	11 ± 2	-	-	> 12 (8 min)	> 10	> 10	> 10	> 10	50 V/500 mA	75 Ω	-25 °C ... + 55°C
NU-464..		SAT IEC m	-	-	-	47-2200	-	-	-	4 ± 1,5	-	-	> 12	-	>12	>12	>12	50 V/500 mA	75 Ω	-25 °C ... + 55°C

Schneider Electric Industries SAS

If you have technical questions, please contact
the Customer Care Centre in your country.

schneider-electric.com/contact