

1

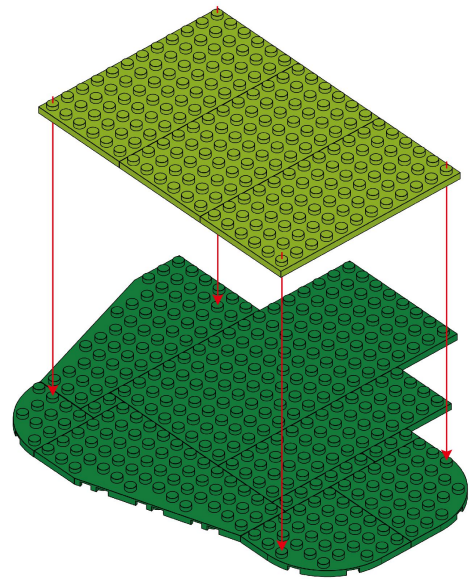

=2=

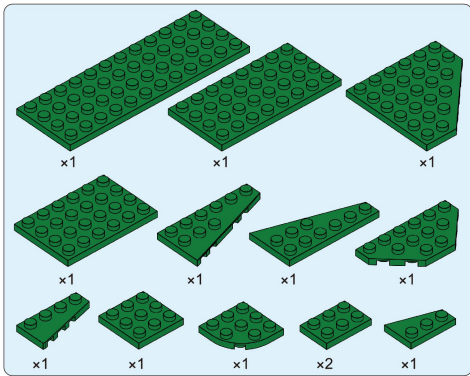

2

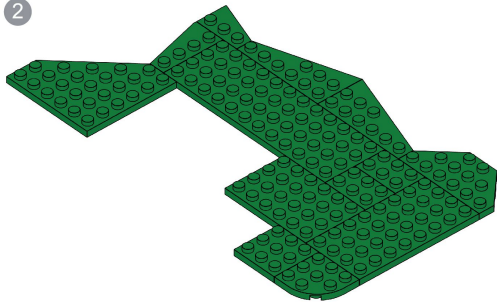

=3=

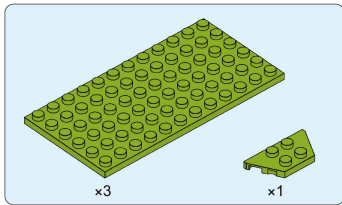

3

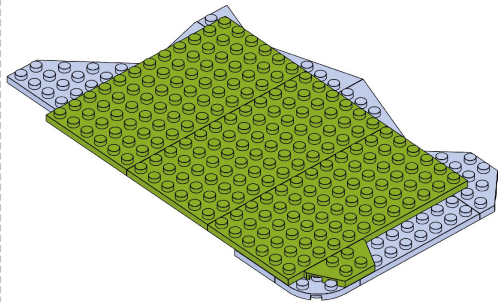

4

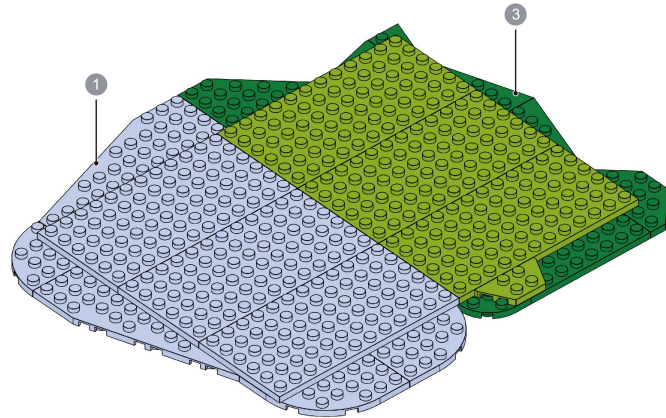

=4=

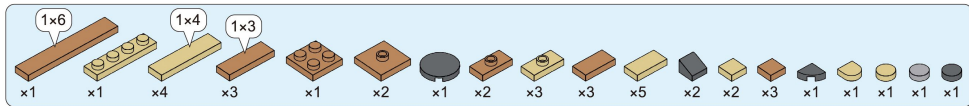

5

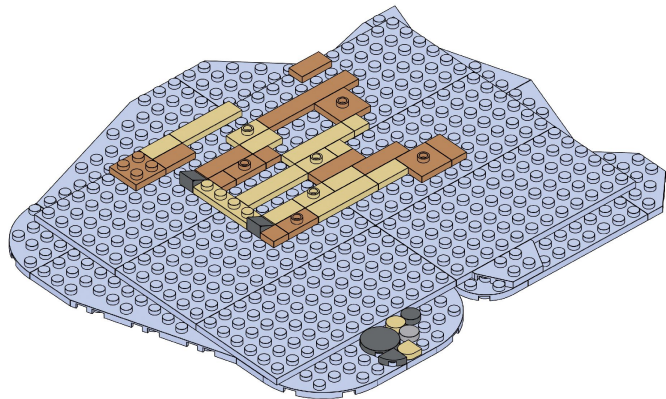

=5=

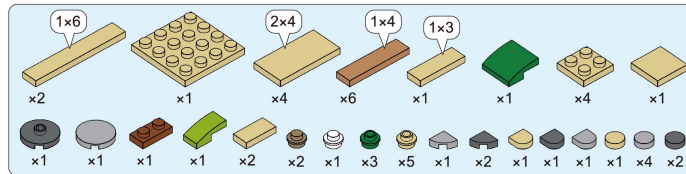

6

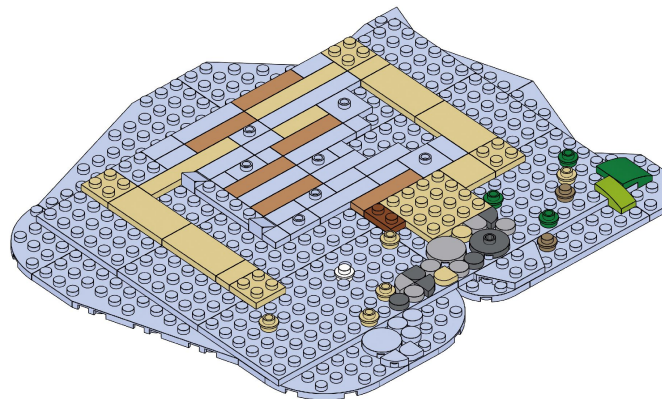

=6=

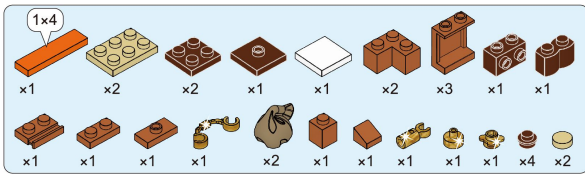

7

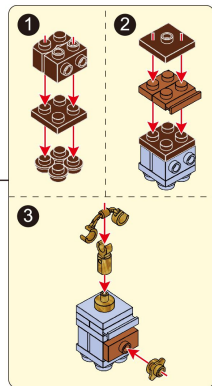
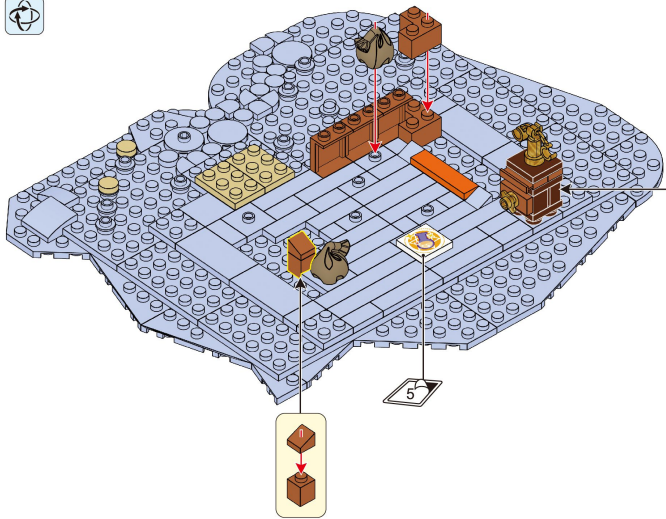

=7=

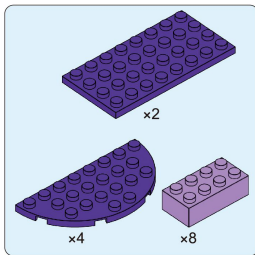

8

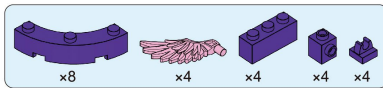
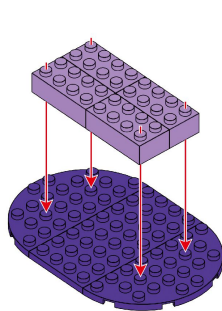

9

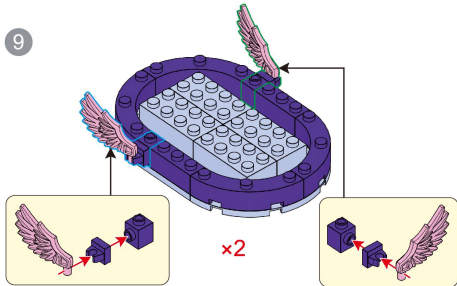

=8=

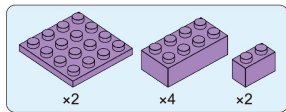

10

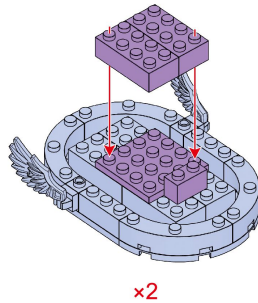

x2



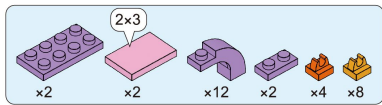

11

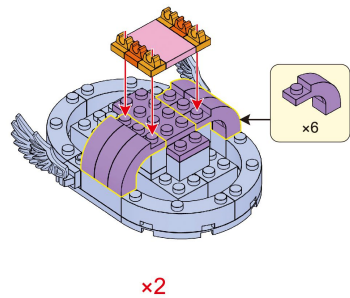

=9=

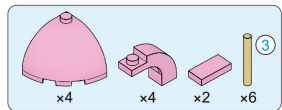

12

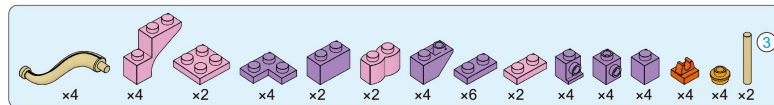
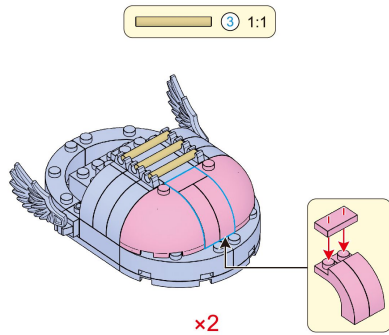

13

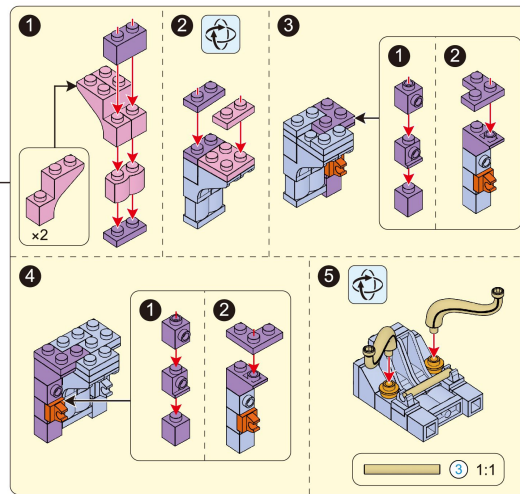
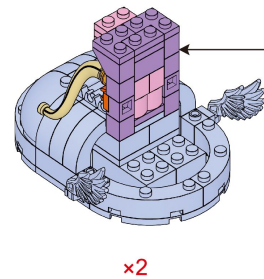

=10=

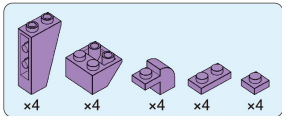

14

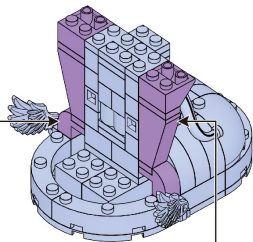

x2

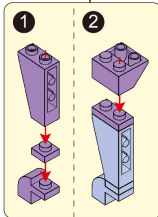

2

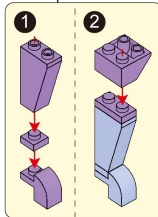

2

=11=

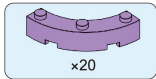

15

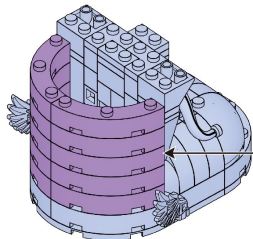

x2

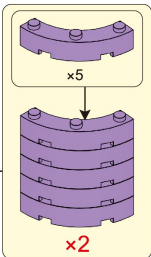

x5

x2

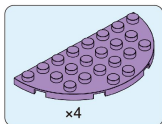

16

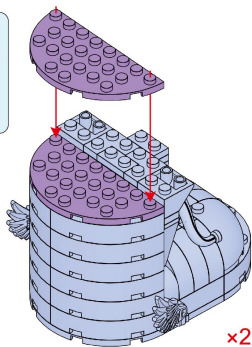

x2

=11=

17

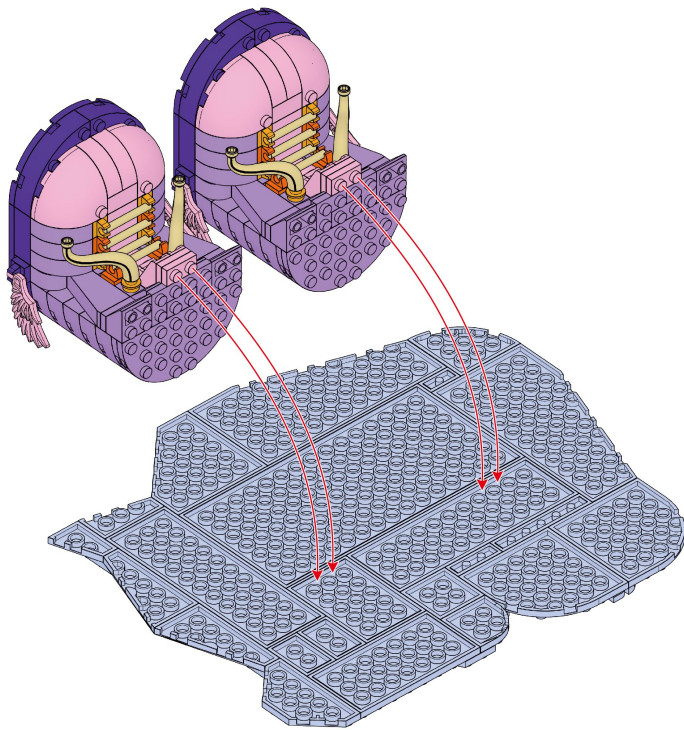

=12=



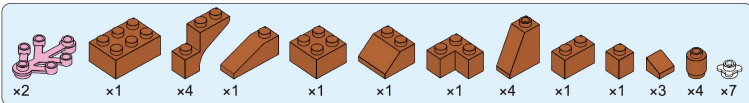

20

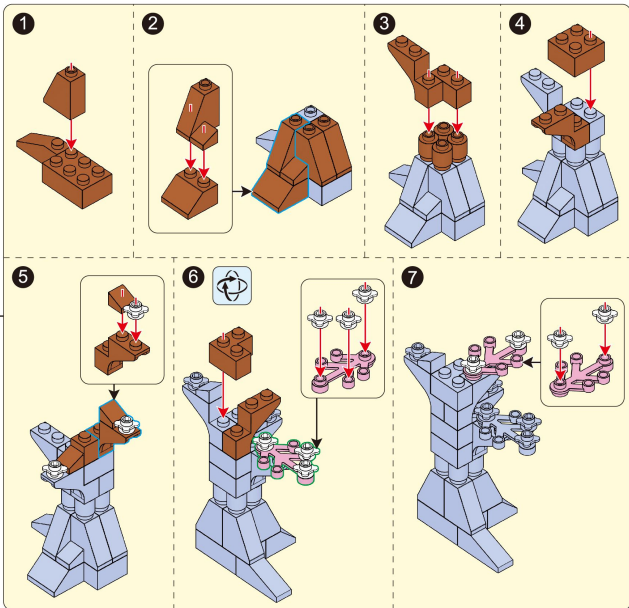
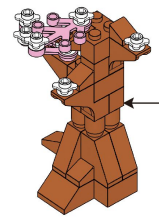

=15=

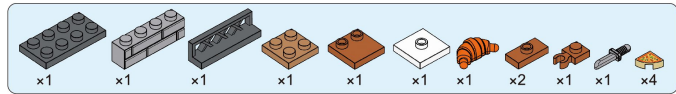

21

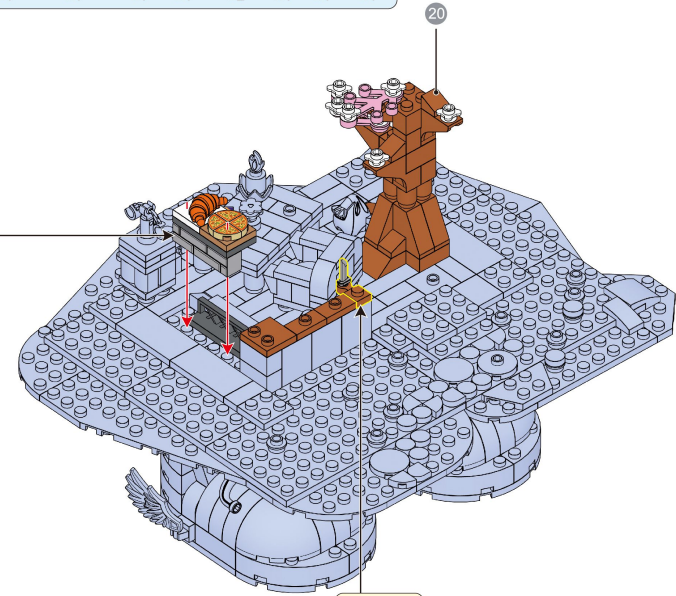
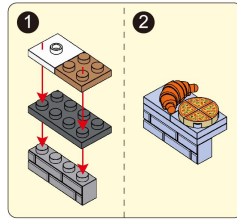

=16=



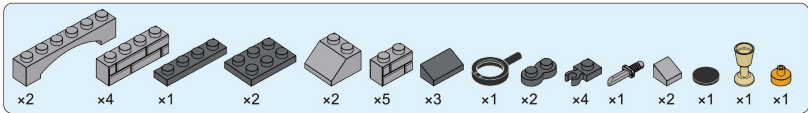

22

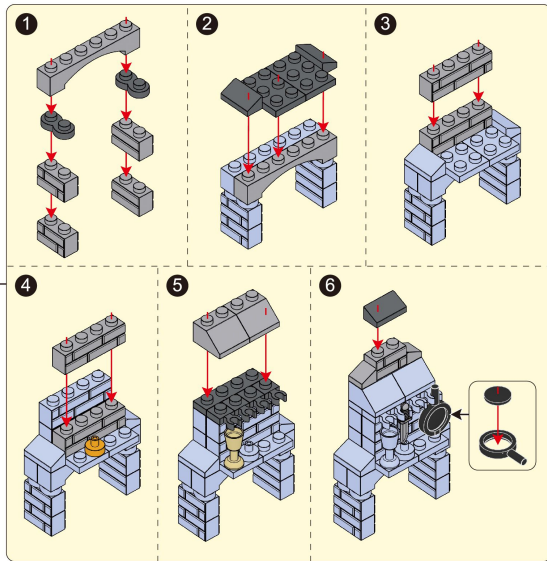
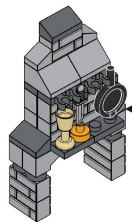

=17=

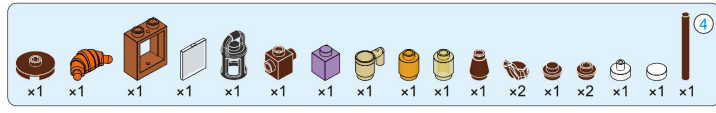

23

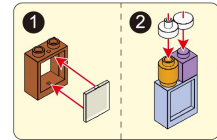
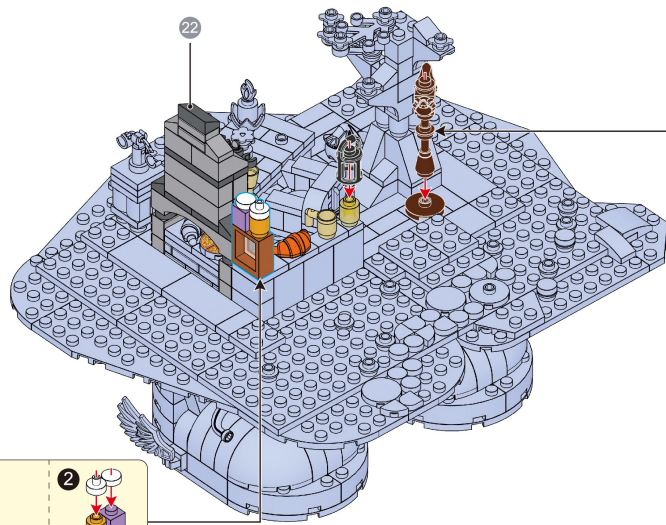

=18=

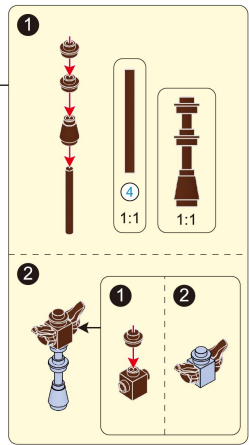

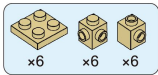

24

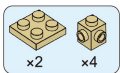
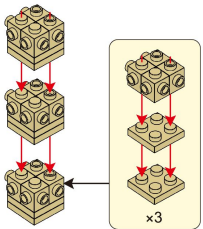

25

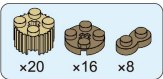
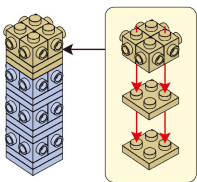

26

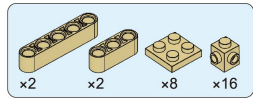
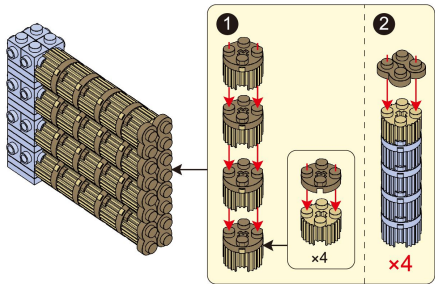

27

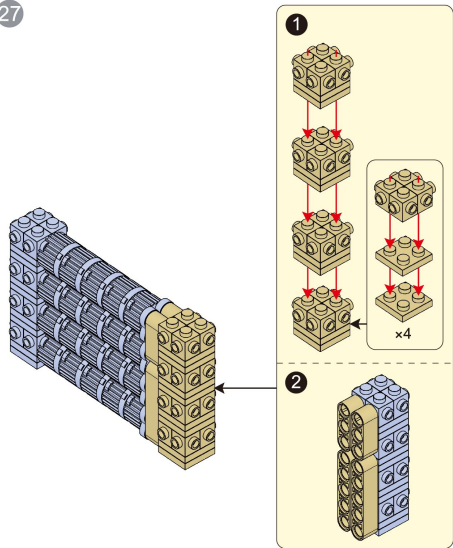

28

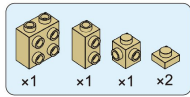
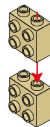

29

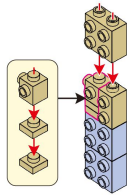

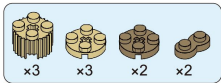

30

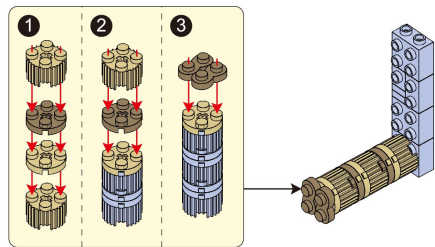

=21=

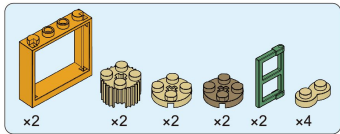

31

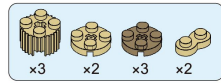
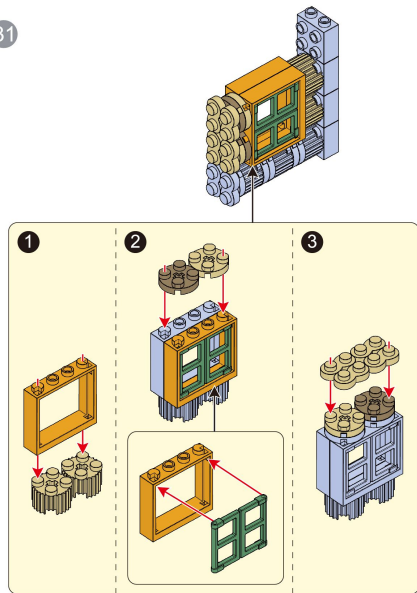

32

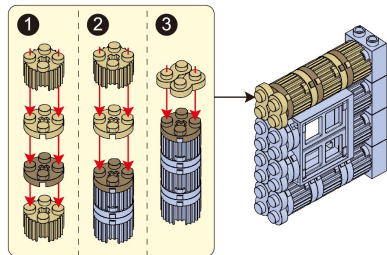

=22=

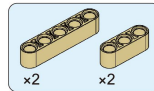

33

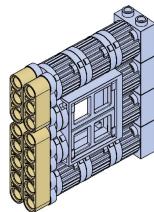

34

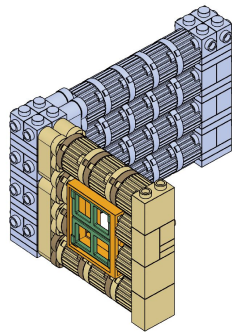

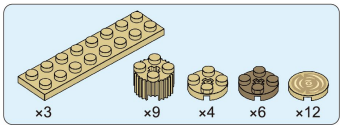

35

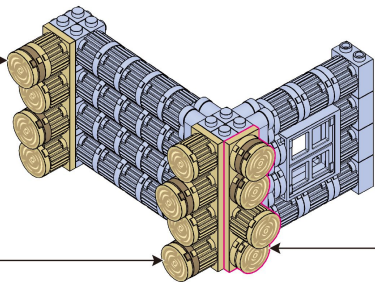
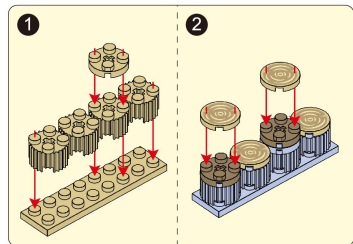
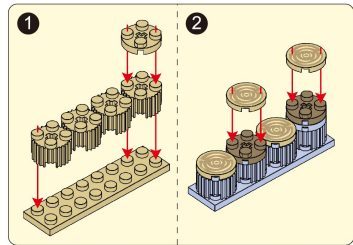

=23=

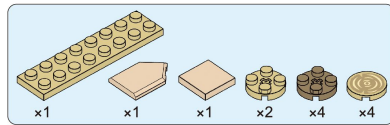
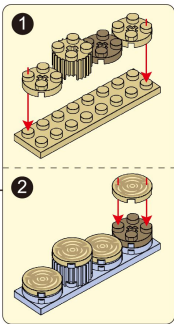

36

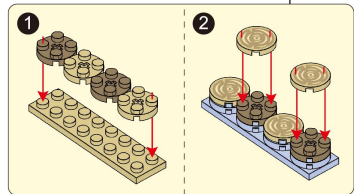
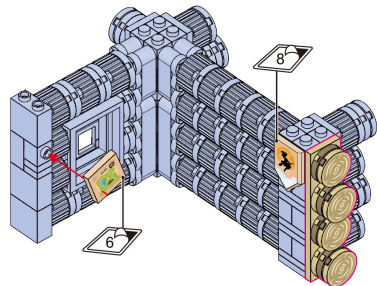

=24=

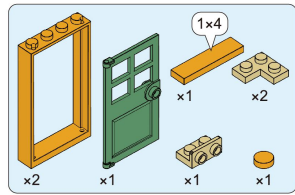

37

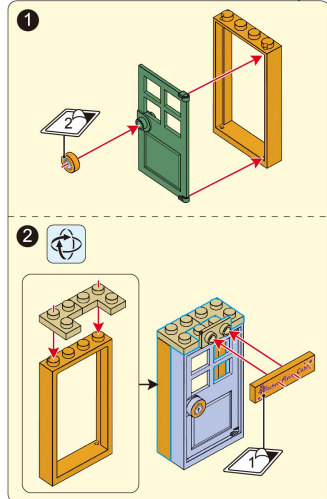



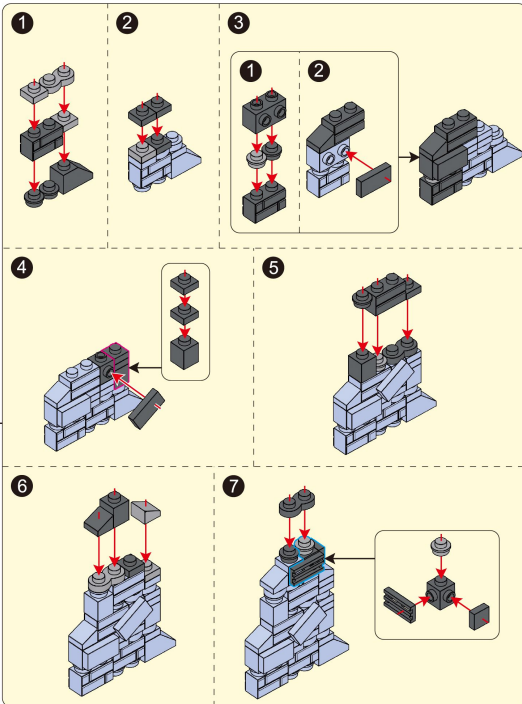
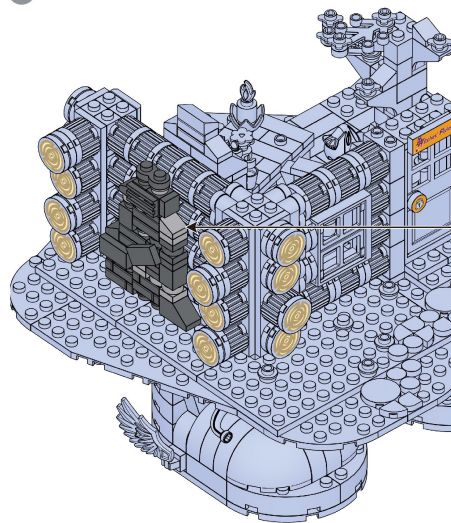
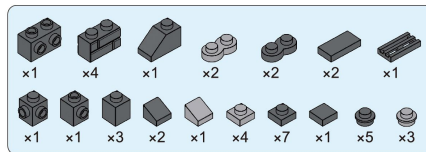
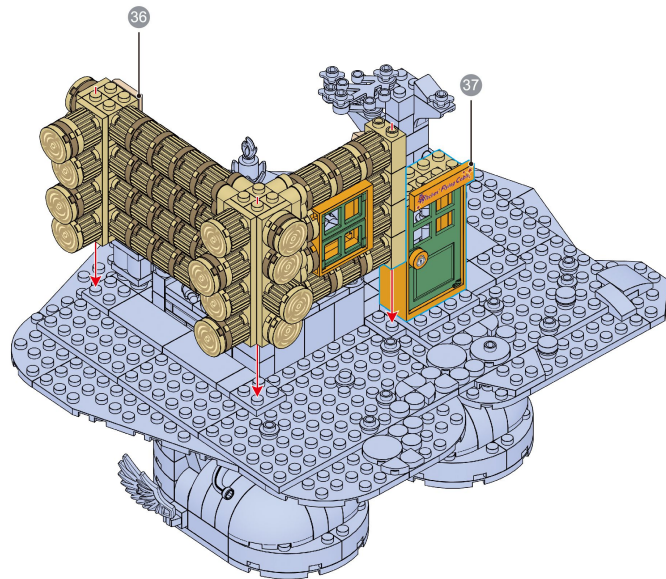

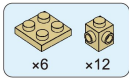

40

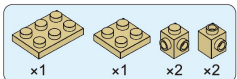
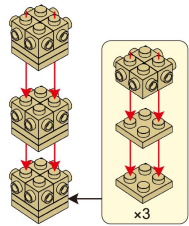

41

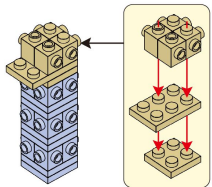

=27=

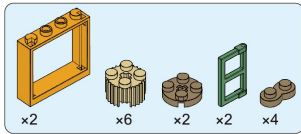

42

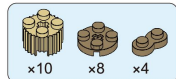
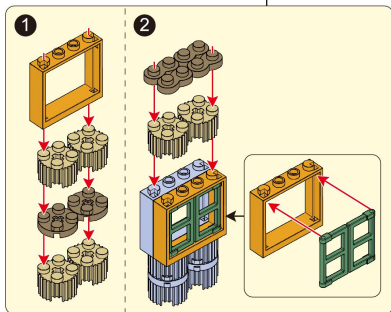
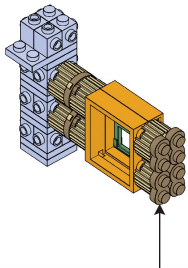

43

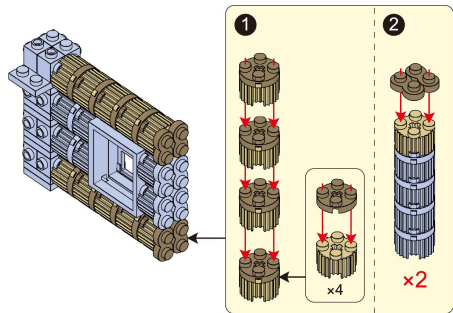

=28=

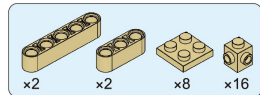

44

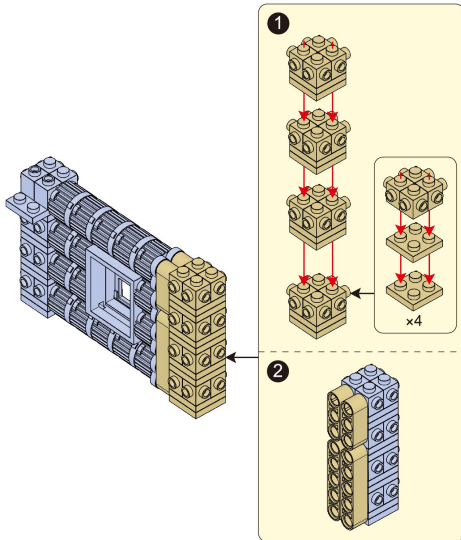

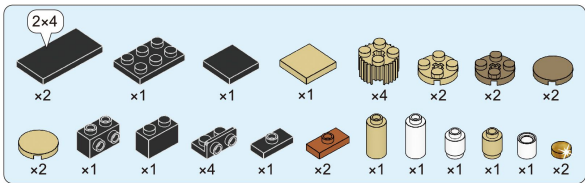

45

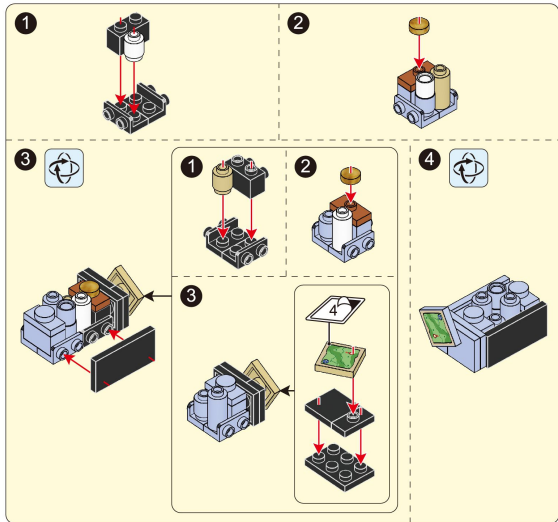

=29=

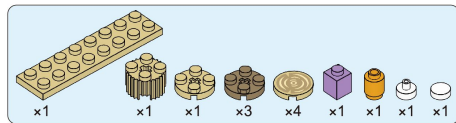
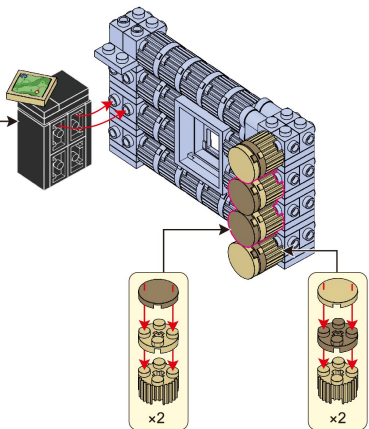

46

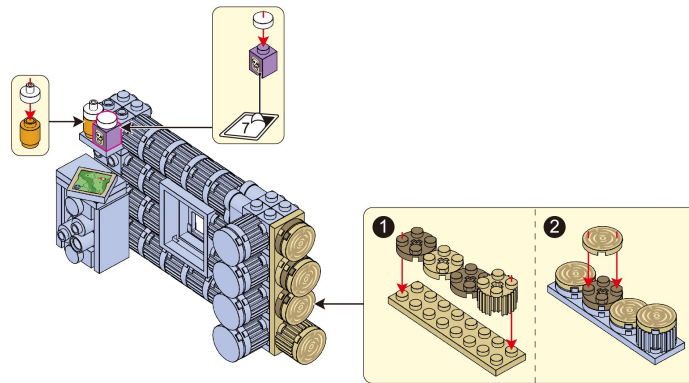

=30=

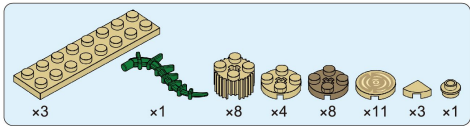

47

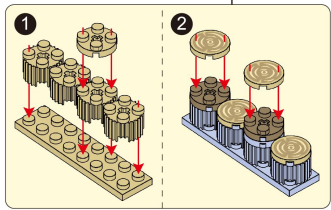
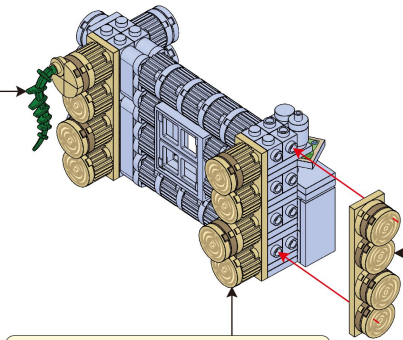
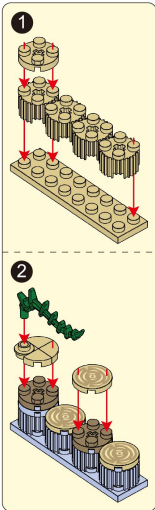

=31=

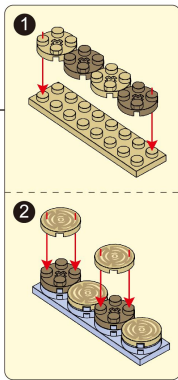

48

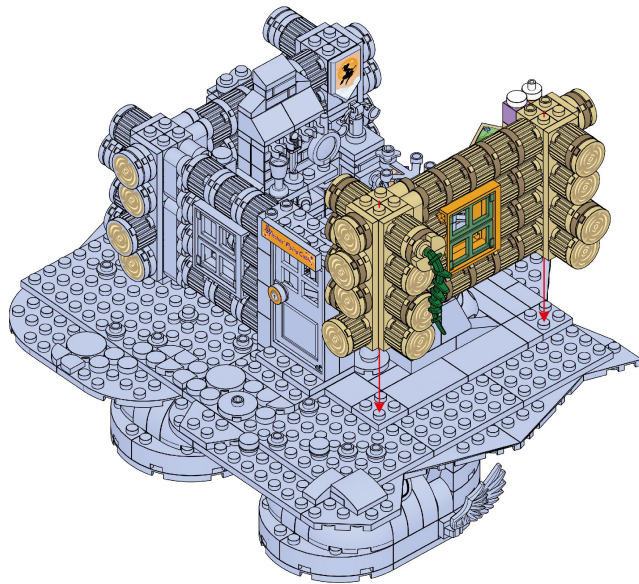

=32=



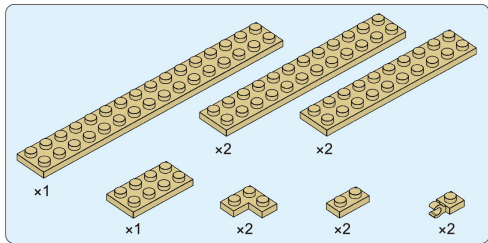

49

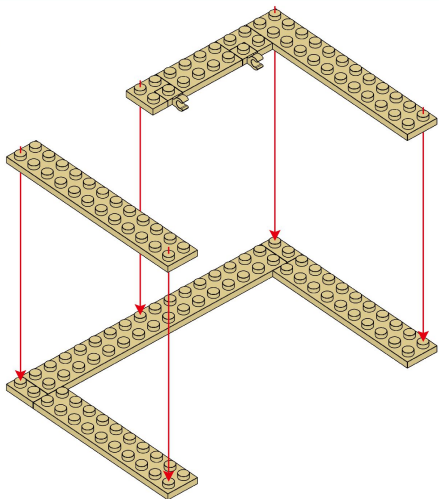

=33=

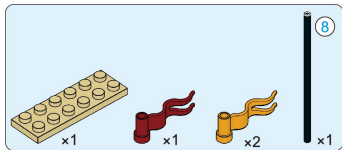

50

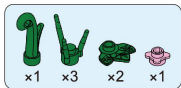
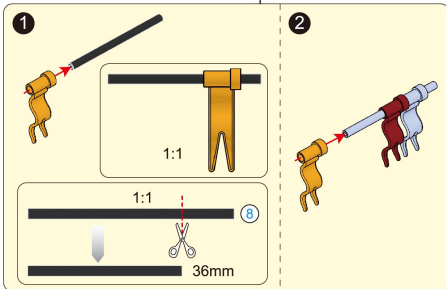
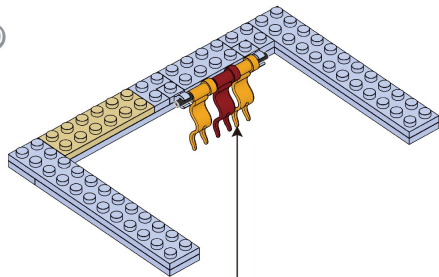

51

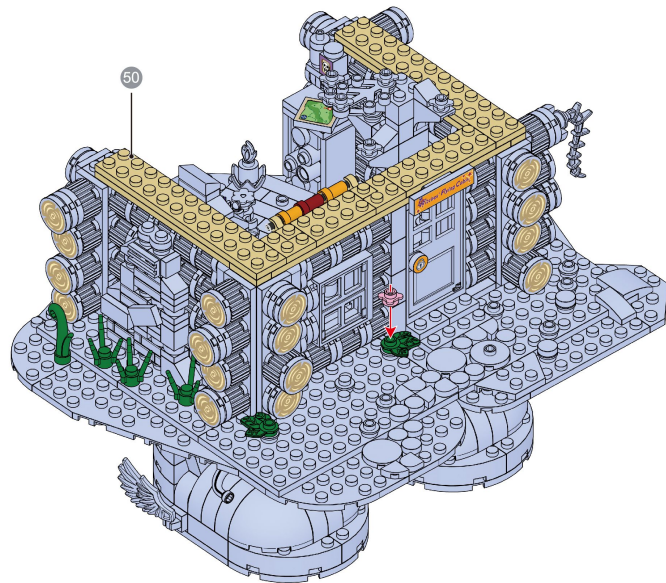

=34=

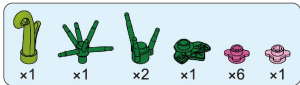

52

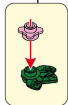
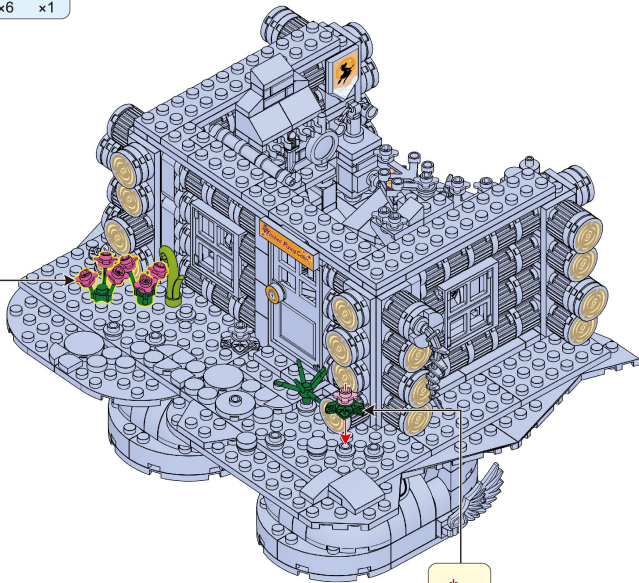
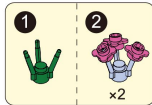

=35=



53

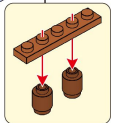
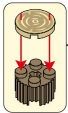
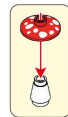
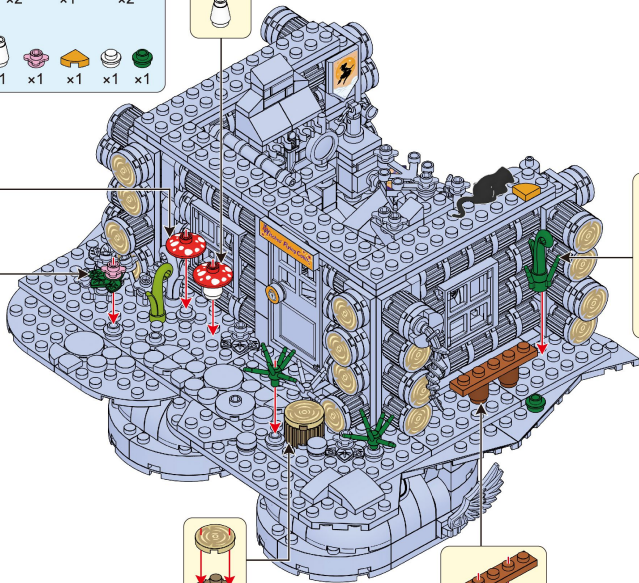
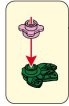

=36=

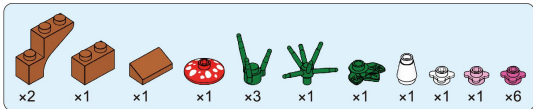

54

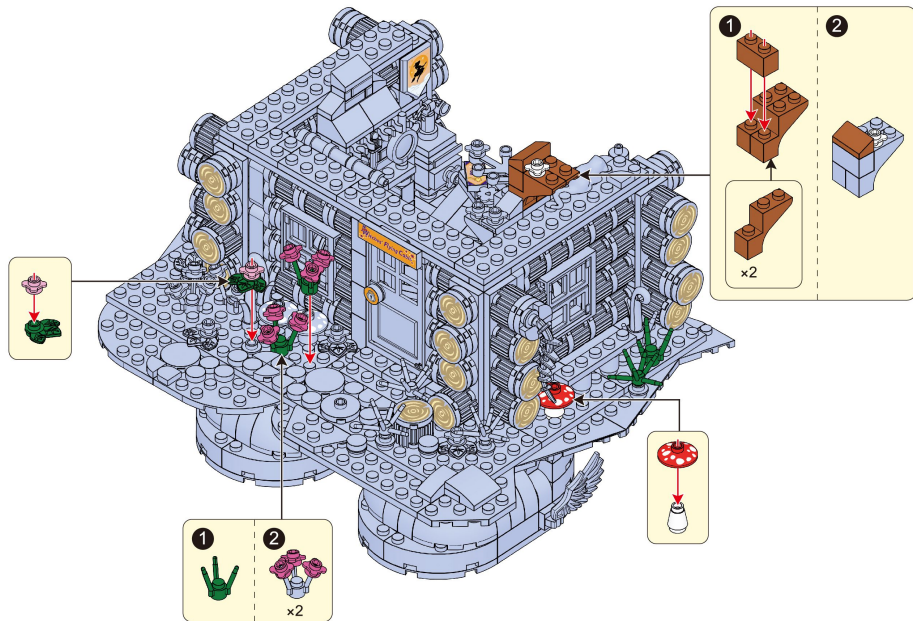

=37=

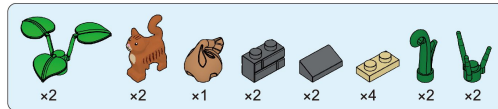

55

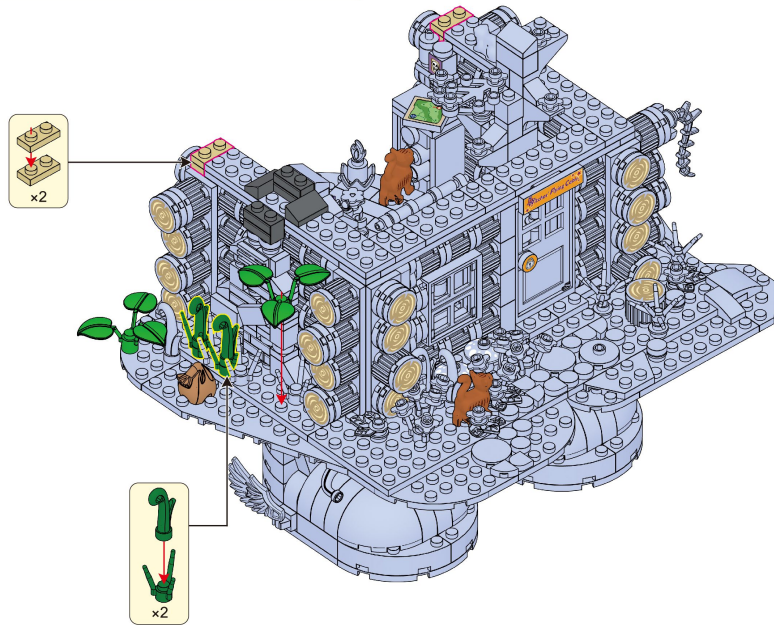

=38=



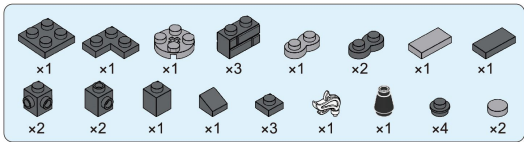

56

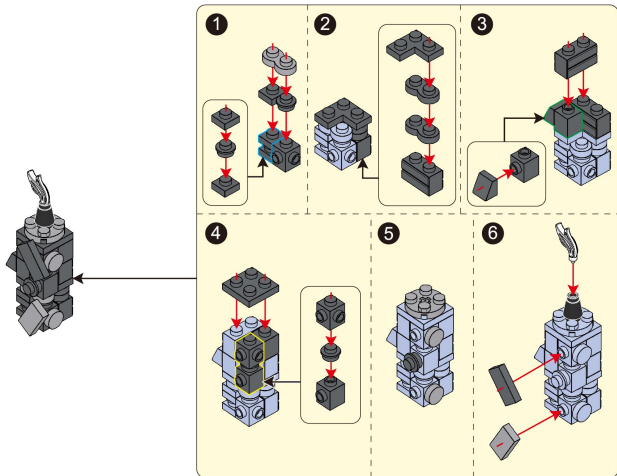

=39=

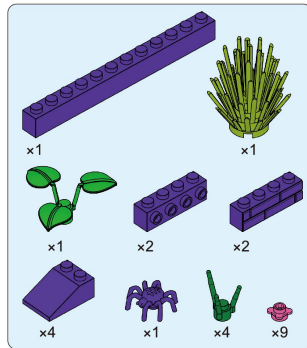

57

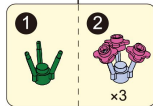
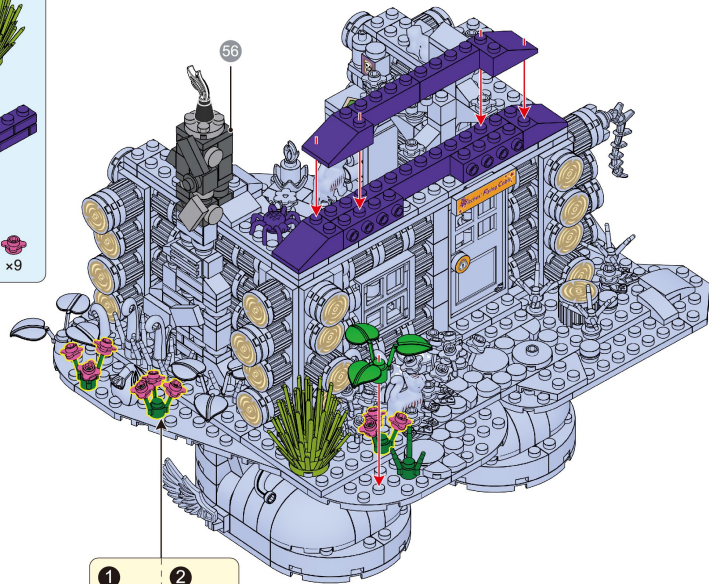

=40=



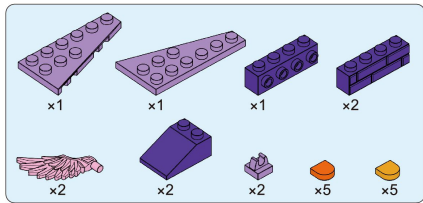

58

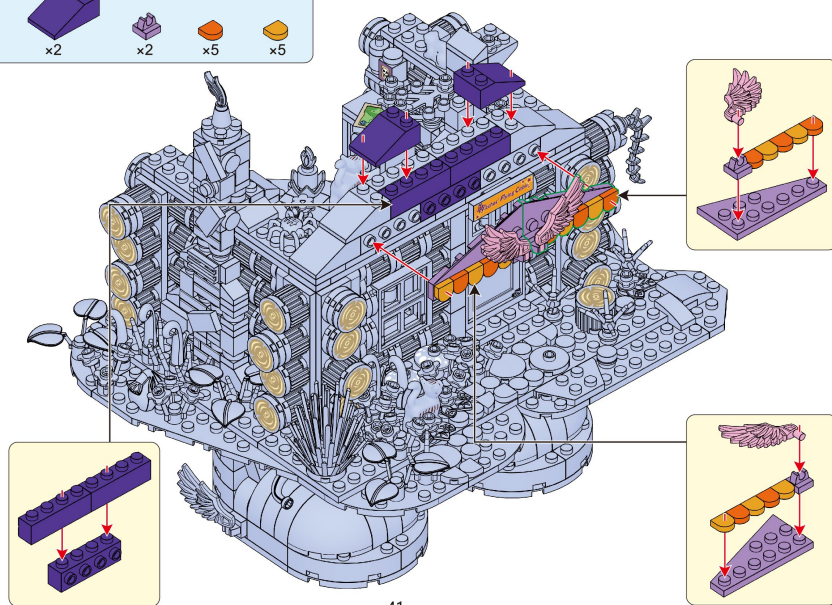

=41=

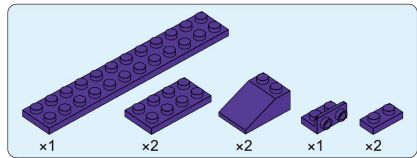

59

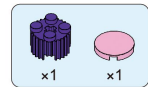
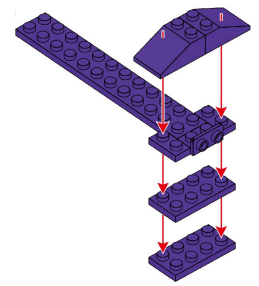

60

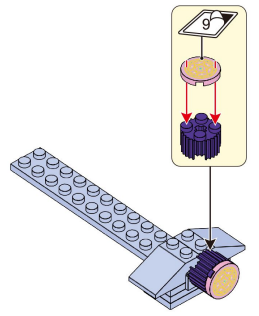

=42=