

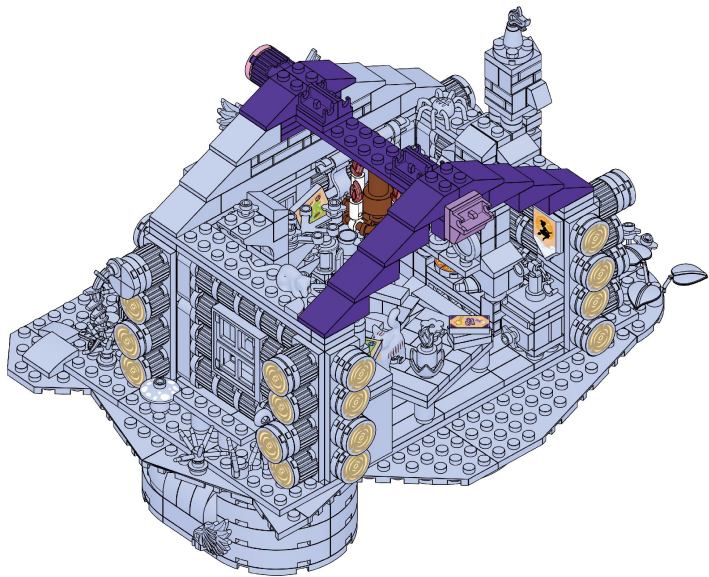

65

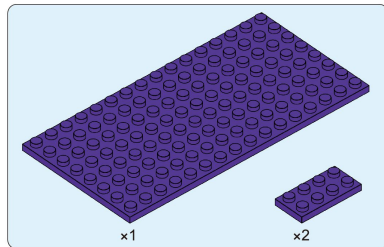

=45=



66

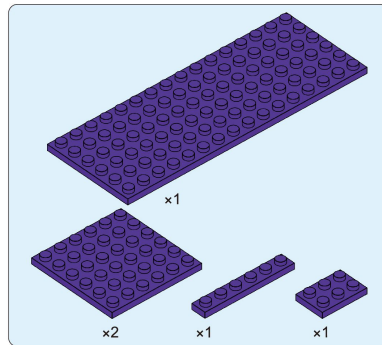
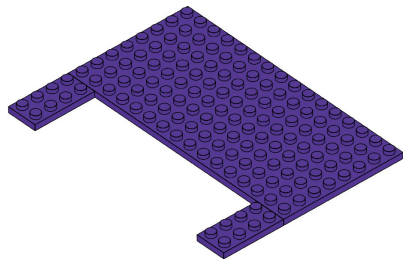

67

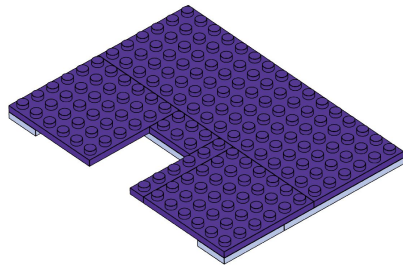

=46=

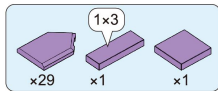

68

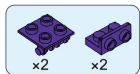
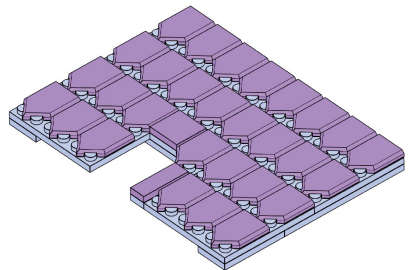

69

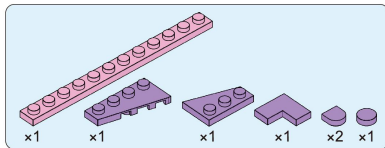
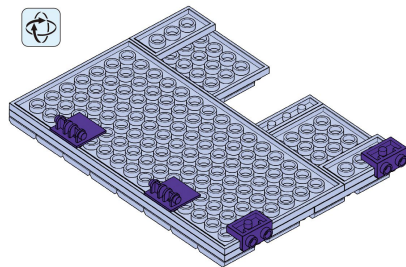

70

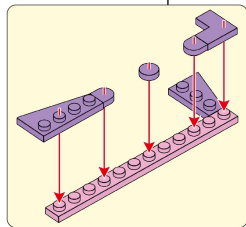
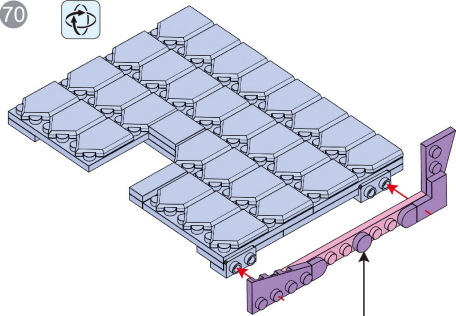

=47=

71

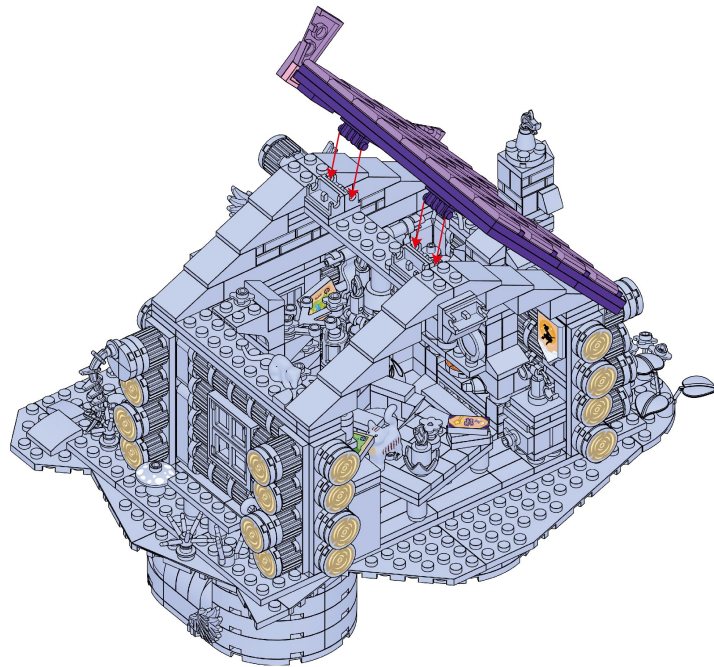

=48=

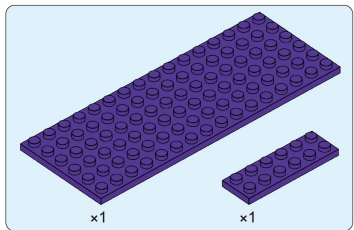

72

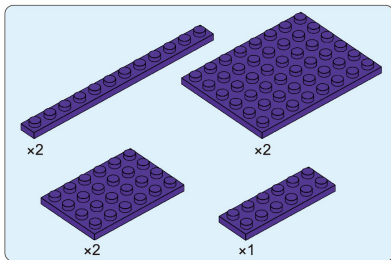
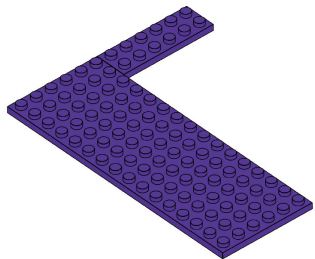

73

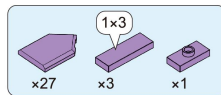
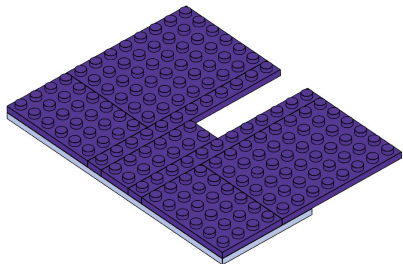

74

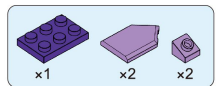
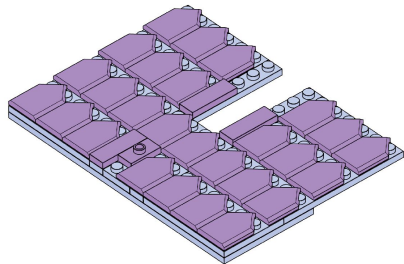

75

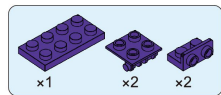
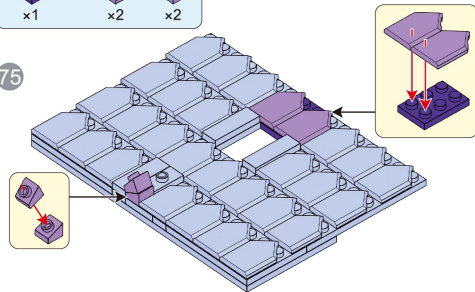

76

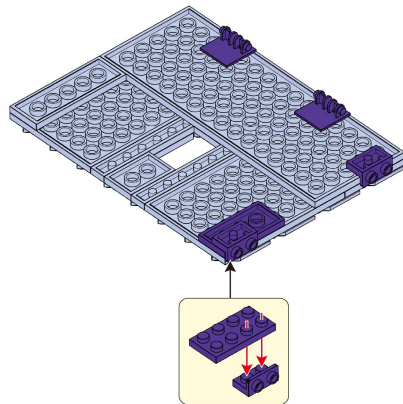



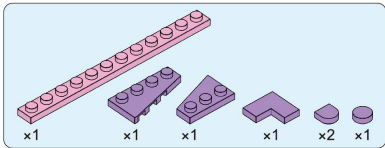

77

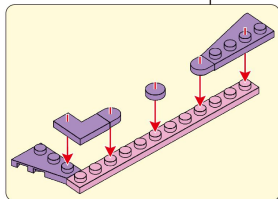
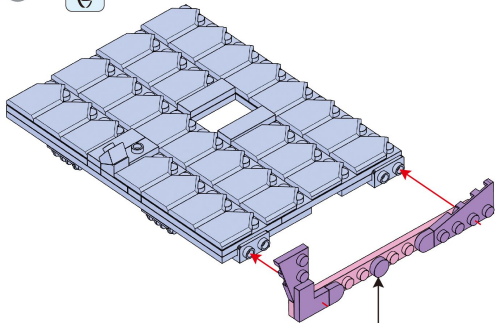

=51=

78

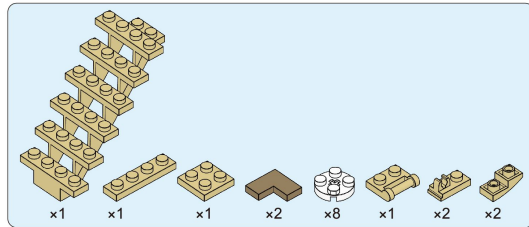
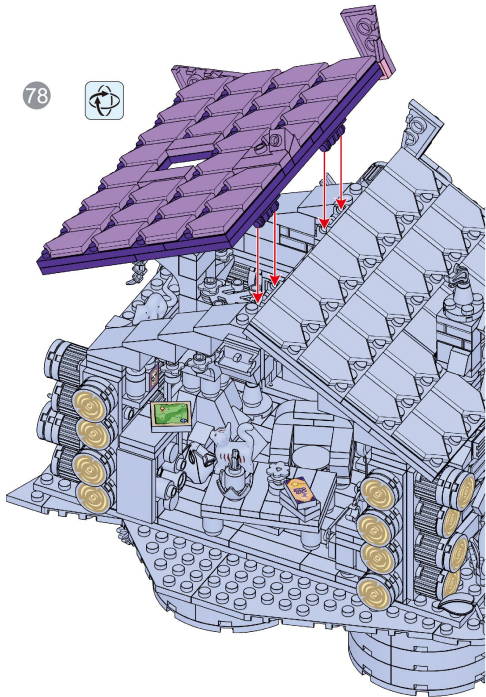

79

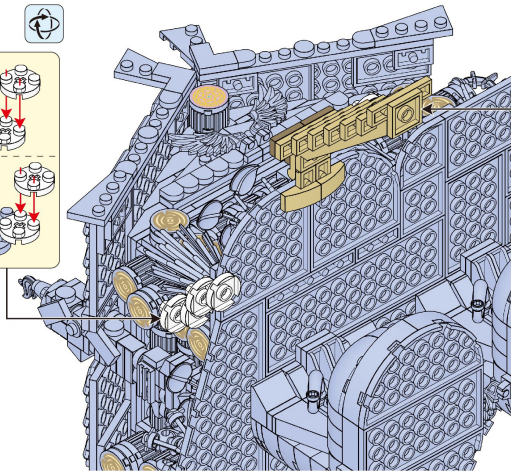
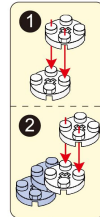

=52=

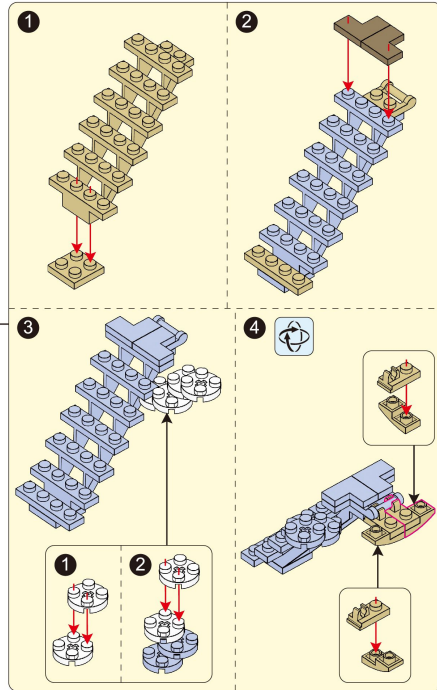

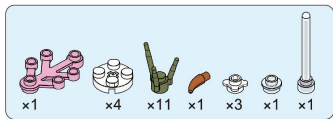

80

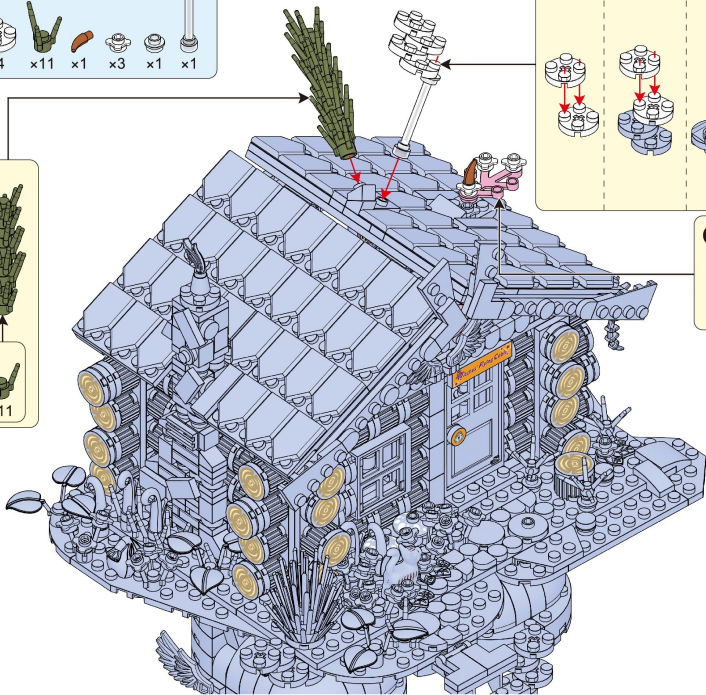
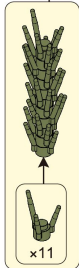

=53=

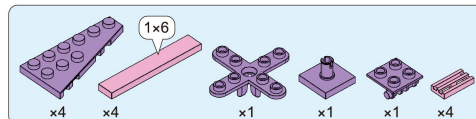
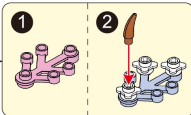
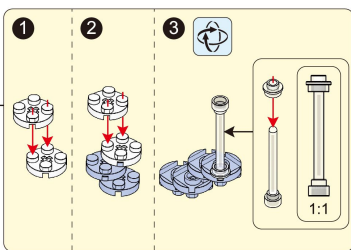

81

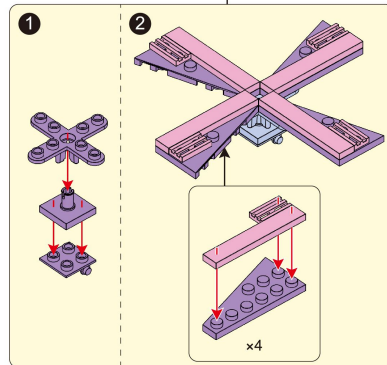
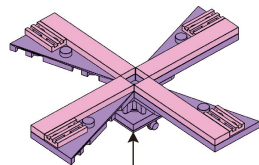

=54=

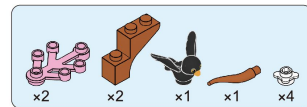

82

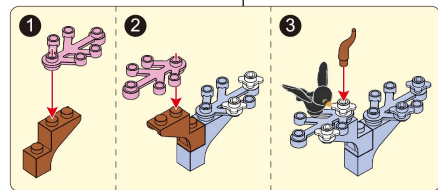
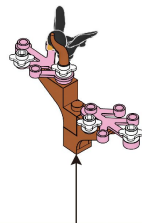

83

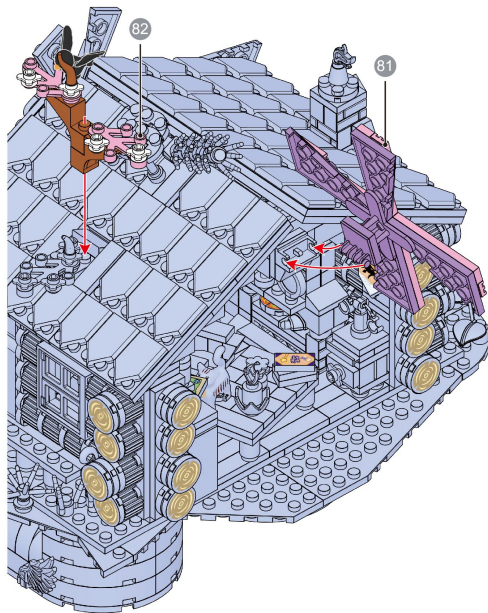

=55=

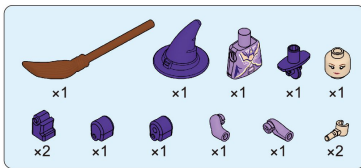

84

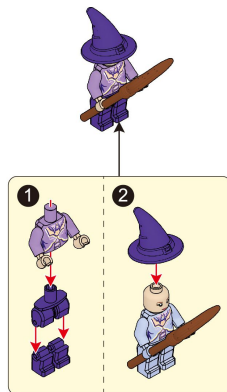

85



=56=



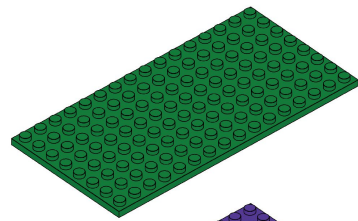

x1

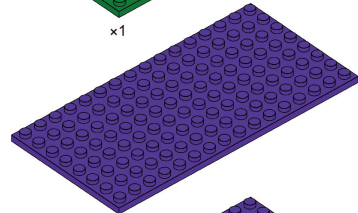

x1

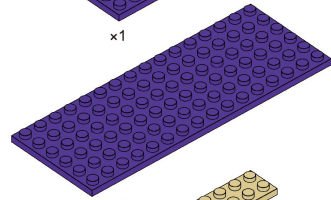

x2

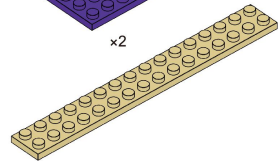

x1

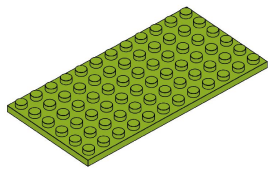

x6

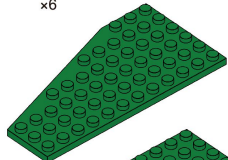

x2

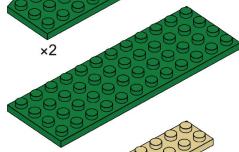

x2

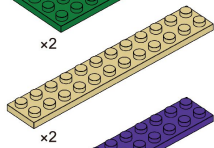

x2

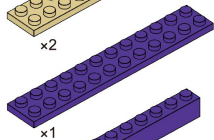

x1

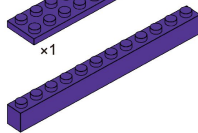

x1

=57=

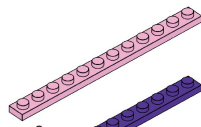

x2

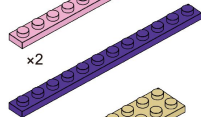

x2

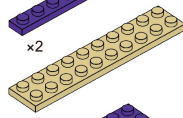

x2

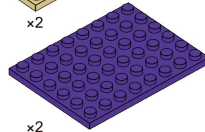

x2

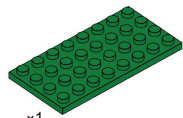

x1

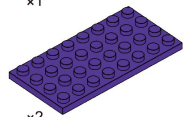

x2

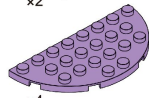

x4

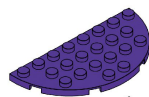

x4

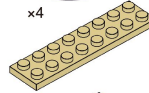

x8

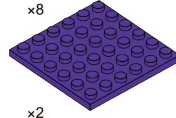

x2

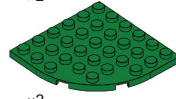

x2

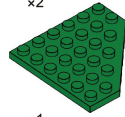

x1

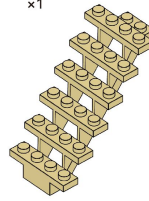

x1



x1

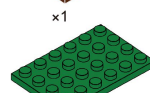

x1

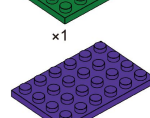

x2

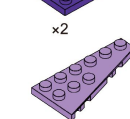

x5

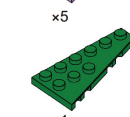

x1

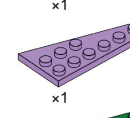

x1

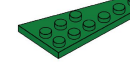

x1

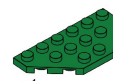

x1

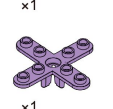

x1

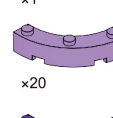

x8

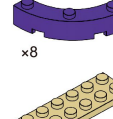

x1

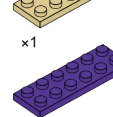

x2

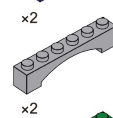

x2

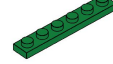

x1

=58=

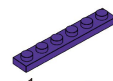

x1

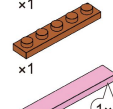

x1

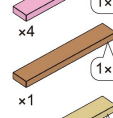

1x6

x4

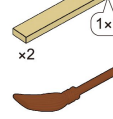

1x6

x1

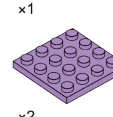

1x6

x2

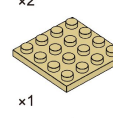

x1



x2

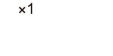

x1



x3

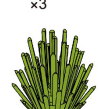

x1

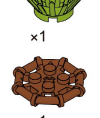

x1



x1

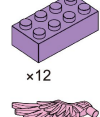

x12

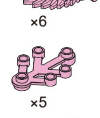

x6

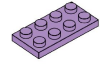

x2



x1

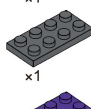

x1

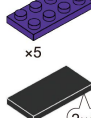

x5

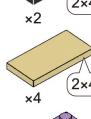

2x4

x2

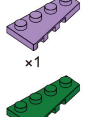

2x4

x4

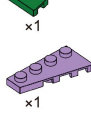

x1



x1



x1



x1



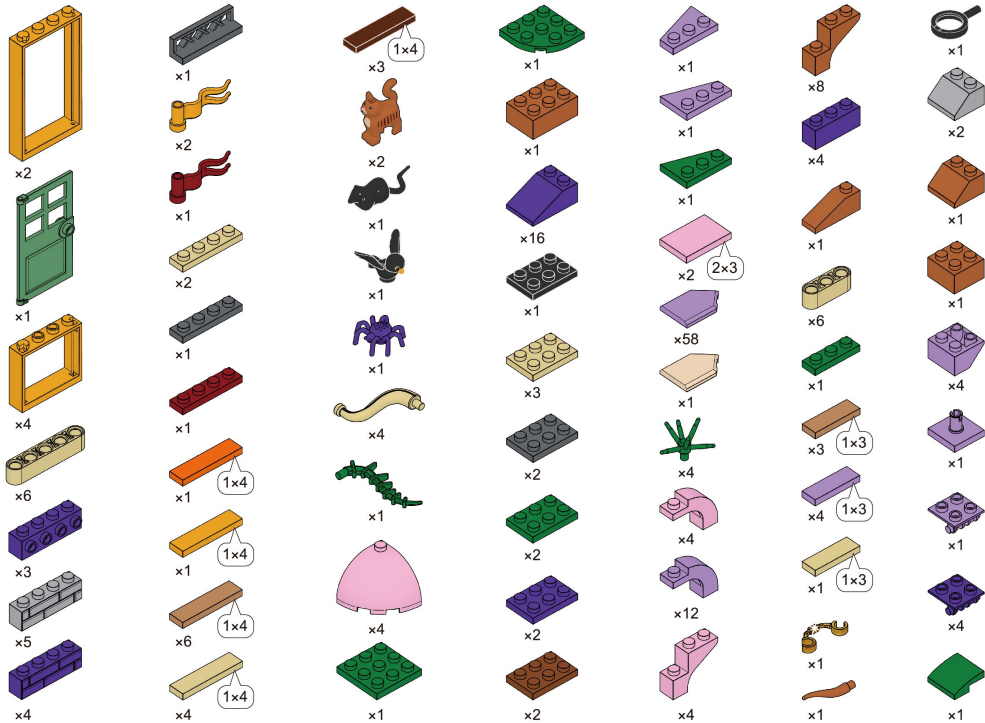

=59=

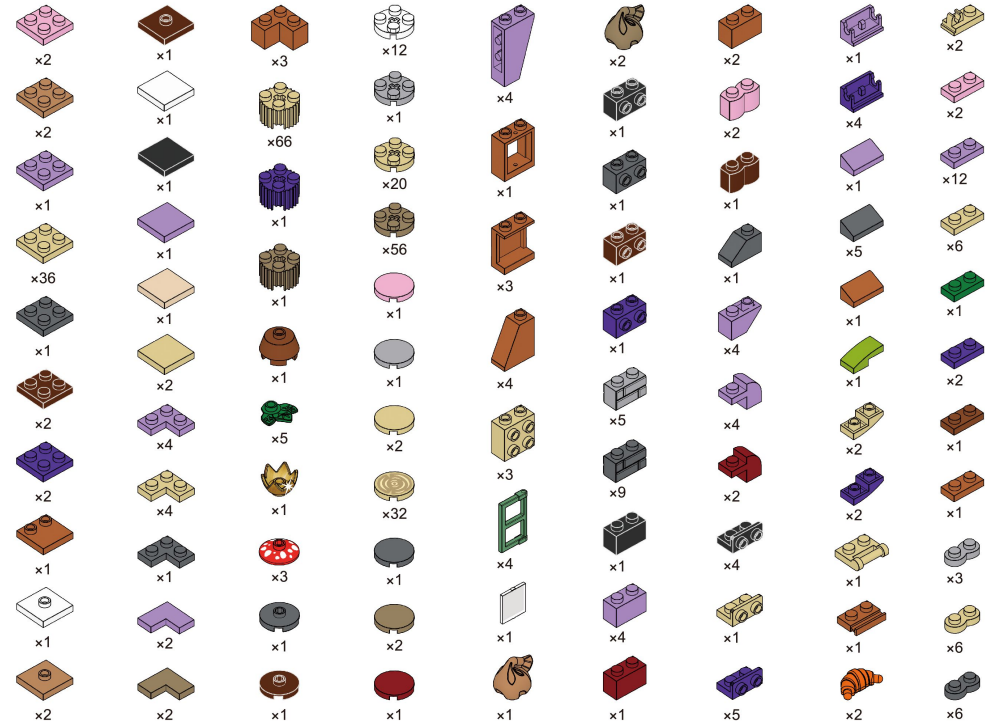

=60=



=61=

