



MID

Wall hung bidet 54x36 cm.

REF: 40362

Wall-hung bidet, with cover. Supports for wall-hung installation available. Very elegant design with a svelte shaft.

Tap fittings not included.

REF 40362

COLOURS/FINISHES

01
White

ARTICLES

Ref	Product/Set	Measurements
	Wall hung bidet	
40362	Wall-hung bidet	54 x 36 cm
51710	Bidet cover	

PRODUCT INFORMATION

Features

Wall-hung bidet 54x36 cm. Can be installed with wall support / 20,5 kg. / 18 units pallet.

Guarantee

Gala products are guaranteed against any manufacturing defects, from the date of purchase of the product, only if the installation has been carried out in accordance with Gala's installation instructions and, applying the current legislation on electrical and sanitary appliances, by authorised staff. The guarantee period for vitreous china is of 5 years.

Installation

Please check our product installation manuals.

Certificates

High quality is a constant at Gala in order to guarantee the technical and aesthetic features as well as the performance of our products. Please check our product quality certificates.

Maintenance

Cleaning should preferably be carried out using liquid detergent and a brush or sponge. Do not scrape with metal blades or steel scourer. Every six months it is advisable to check the wastepipe connections and check that there are no leaks.

COMPLEMENTS



SUGGESTIONS



SETTING





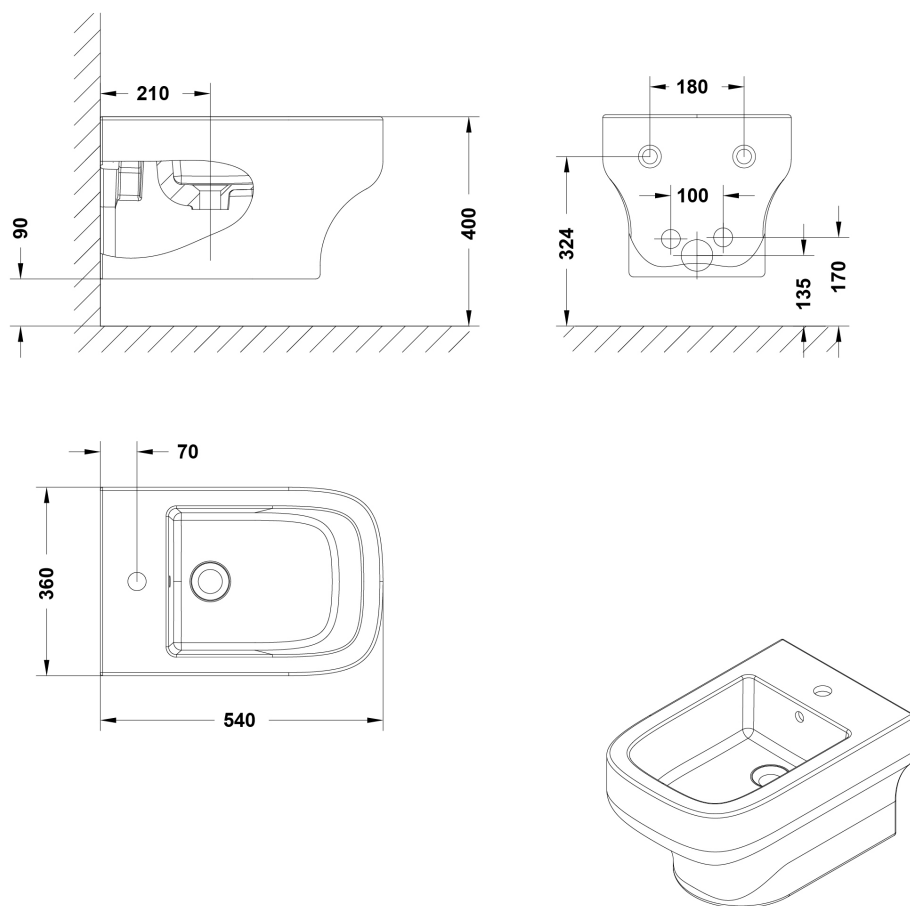



TECHNICAL DRAWINGS





Downloads

2D

-  262.55 KB  Wall hung bidet 54x36 cm. - Técnico (.AI)
-  212.66 KB  Wall hung bidet 54x36 cm. - Técnico (.DWG)

 1.15 MB  Wall hung bidet 54x36 cm. - Técnico (.DXF)

 273.04 KB  Wall hung bidet 54x36 cm. - Técnico (.PDF)

bimobject

 ArchiCAD 

 Revit 

VIDEOS