



MID

Wash-basin 60x45 cm.

REF: 40035

Spacious and elegant over-counter wash-basin with fine walls and thin edges and a functional back shelf for soaps and accessories. The new trend of thin walls in vitreous china is here thanks to the collection Mid.

Tap fittings not included.

REF 40035

COLOURS/FINISHES

01
White

ARTICLES

Ref	Product/Set	Measurements	€/u
40035	Wash-basin with overflow	60 x 45 cm	

PRODUCT INFORMATION

Features

Wash-basin 60 x 45 cm. with overflow. / 17 Kg./ 24 units pallet. Wall-hung installation.

Guarantee

Gala products are guaranteed against any manufacturing defects, from the date of purchase of the product, only if the installation has been carried out in accordance with Gala's installation instructions and, applying the current legislation on electrical and sanitary appliances, by authorised staff. The guarantee period for vitreous china is of 5 years.

Installation

Please check our product installation manuals.

Certificates

High quality is a constant at Gala in order to guarantee the technical and aesthetic features as well as the performance of our products. Please check our product quality certificates.

Maintenance

Cleaning should preferably be carried out using liquid detergent and a brush or sponge. Do not scrape with metal blades or steel scourer. Every six months it is advisable to check the wastepipe connections and check that there are no leaks.

COMPLEMENTS



SUGGESTIONS

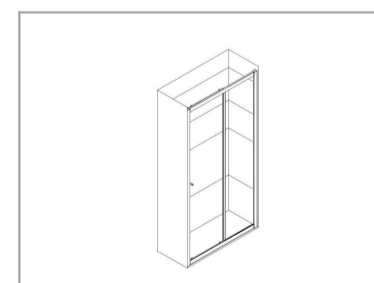







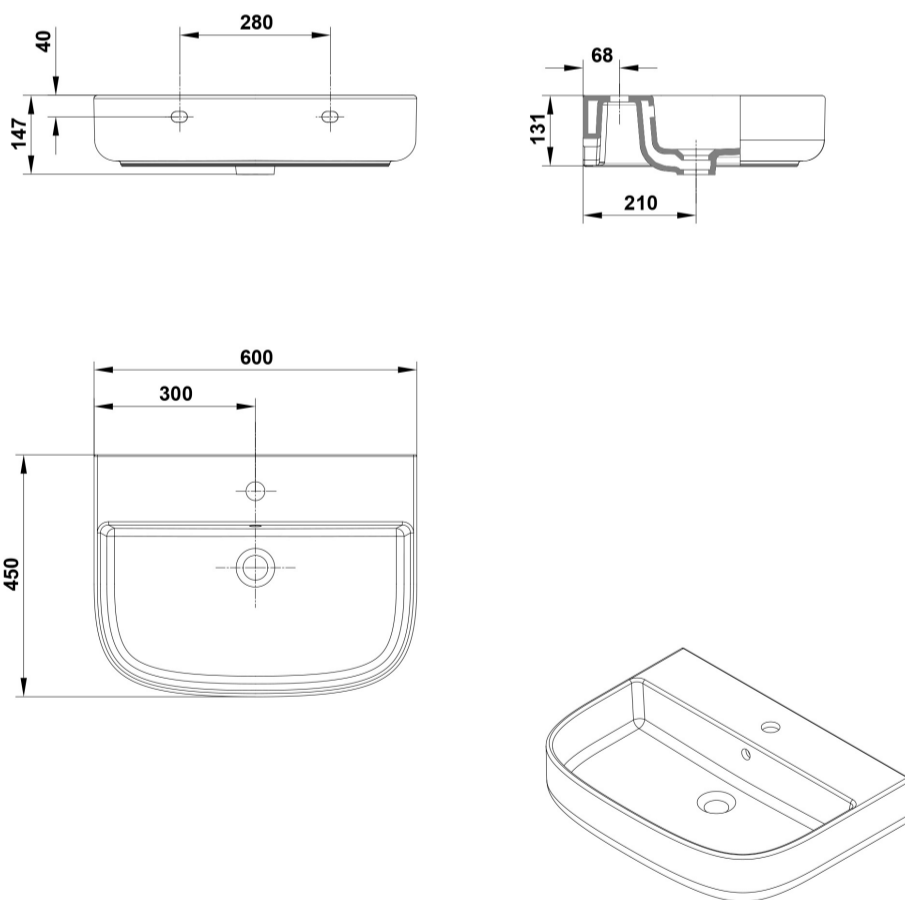

SETTING



TECHNICAL DRAWINGS



2D

-  362.21 KB  Wash-basin 60x45 cm. - Técnico (.AI)
-  526.54 KB  Wash-basin 60x45 cm. - Técnico (.DWG)
-  3.78 MB  Wash-basin 60x45 cm. - Técnico (.DXF)
-  378 KB  Wash-basin 60x45 cm. - Técnico (.PDF)

bimobject

-  ArchiCAD 
-  Revit 

VIDEOS