



NINJAGO

DRAGONS RISING

71792





Get excited about our new packaging!

We're switching from plastic to paper-based packaging. That's why you might find a mix of paper and plastic in our boxes!

Nos nouveaux emballages vous emballeront !

Nous passons des emballages en plastique aux emballages à base de papier. C'est pourquoi vous pourriez trouver un mélange de papier et de plastique dans nos boîtes !

¡Te presentamos nuestros nuevos empaques!

Estamos sustituyendo las bolsas de plástico por bolsas con base de papel. ¡Por eso, puedes encontrar una mezcla de papel y de plástico en nuestras cajas!

[LEGO.com/sustainable-packaging](https://www.lego.com/sustainable-packaging)



BUILDER



Apple and the Apple logo are trademarks of Apple Inc., registered in the U.S. and other countries and regions. App Store is a service mark of Apple Inc. Google Play and the Google Play logo are trademarks of Google LLC. Tencent and the Tencent logo are trademarks of Tencent Inc.

Q [LEGO.com/devicecheck](https://www.lego.com/devicecheck)

EN Ask parents' permission before going online | DE Eltern um Erlaubnis bitten, bevor du online gehst | FR Demande l'autorisation d'un parent avant d'aller en ligne | IT Chiedi il permesso ai tuoi genitori prima di andare online | ES Pídeles permiso a tus papás antes de conectarte a Internet | PT pede autorização aos pais antes de acederes online | ZH 上网前应先征得父母的同意 | PL Poproś rodziców o zgodę, zanim wejdiesz do Internetu | CS Než půjdeš na internet, požádej rodiče o svolení | SK Skôr než půjdeš na internet, vypýtaj si povolenie od rodičov | HU Kérj szülői engedélyt, mielőtt online csatlakoznál! | RO Cere permisiunea părinților înainte de a te conecta online | BG Поискайте разрешение от родител, преди да влезете онлайн | LV Pirms došanās tiešsaistē palūdz atļauju vecākiem | ET Enne Interneti kasutamist küsi vanematelt luba | LT Prieš prisijungdami prie interneto, atsi klauskite tėvų

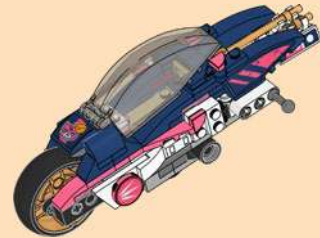
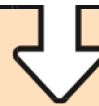
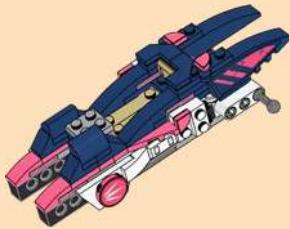

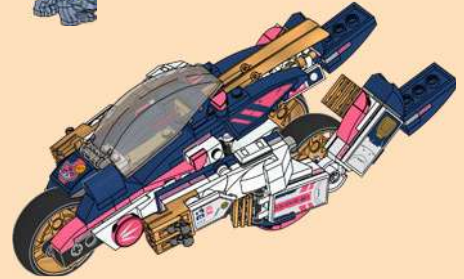
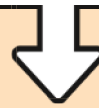
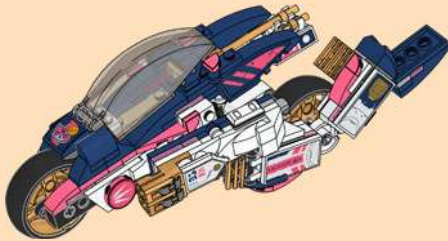



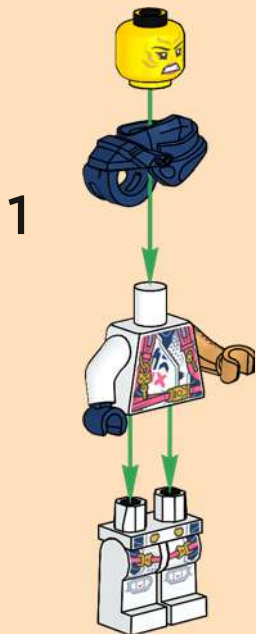
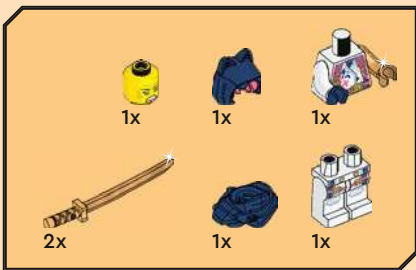

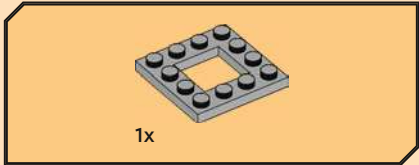
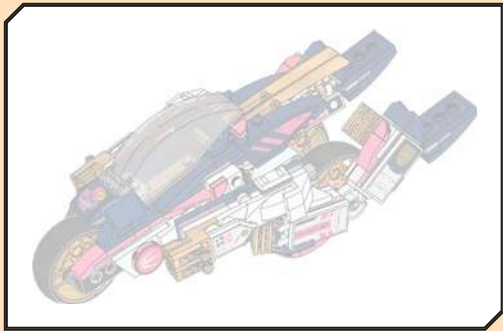

1

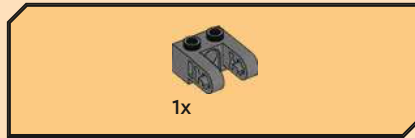
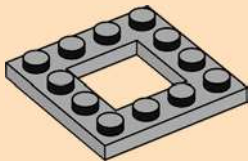

2

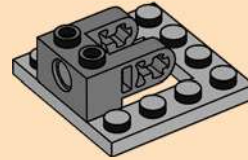

3

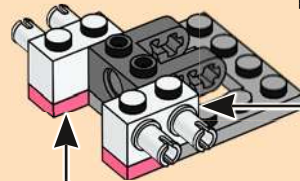
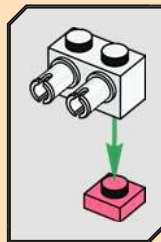
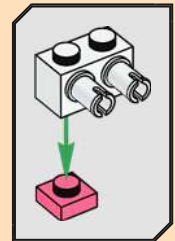

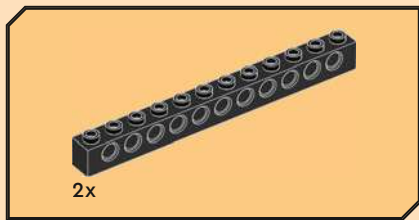

4

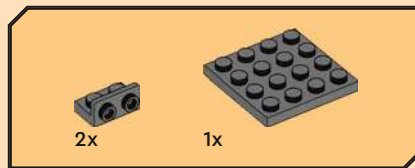
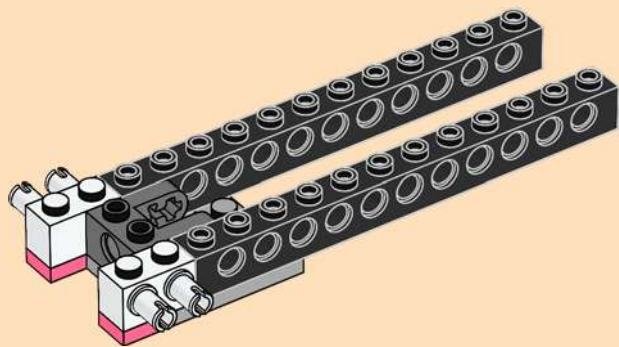

5

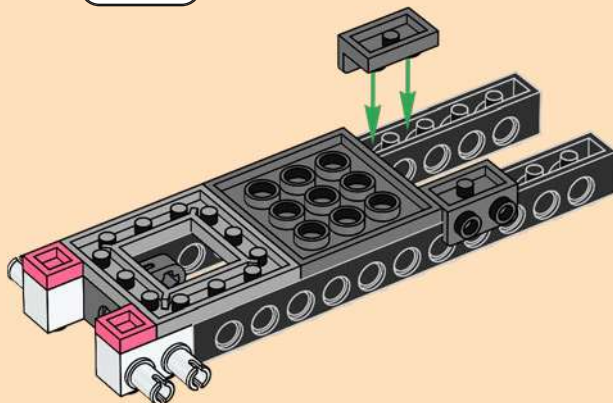

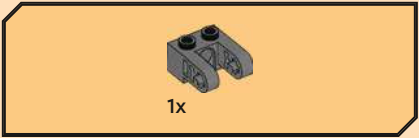

6

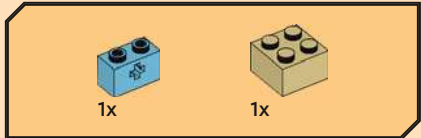
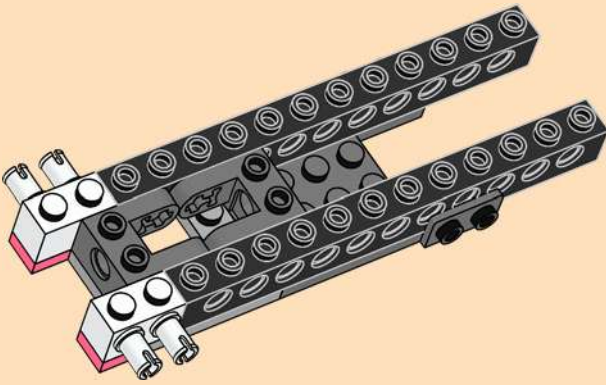

7

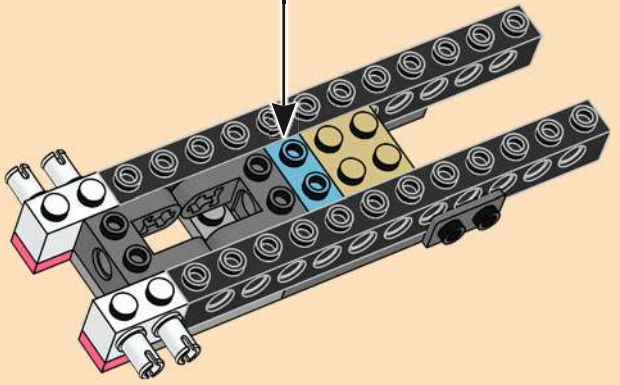
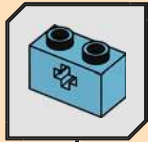



8

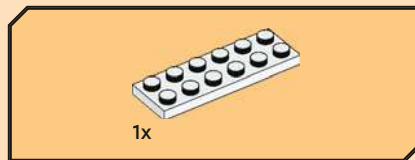
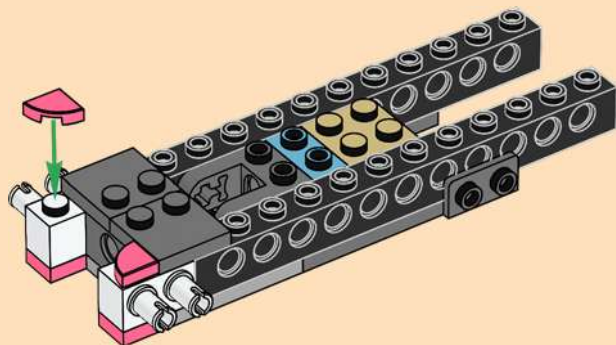

9

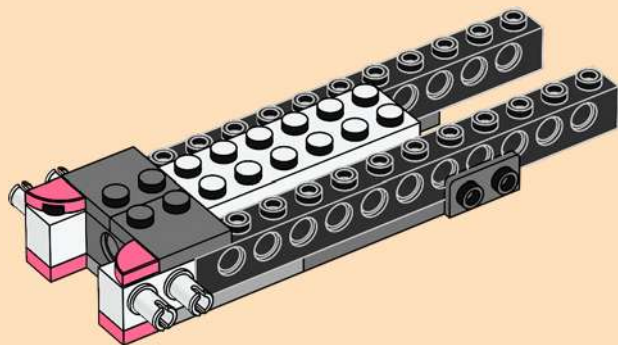

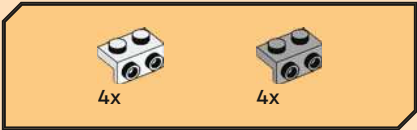

10

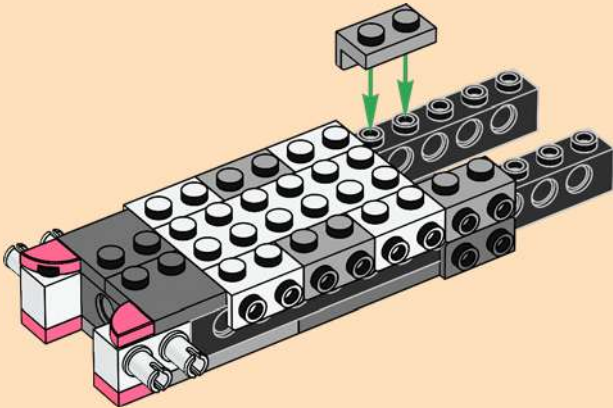

11

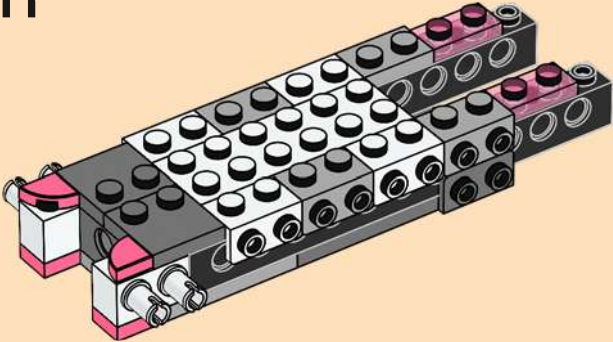

12

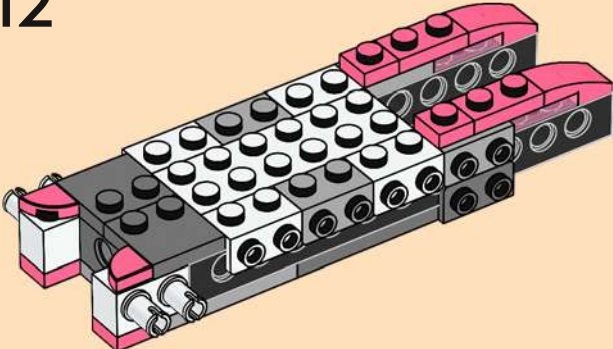

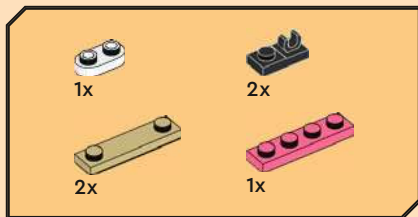

13

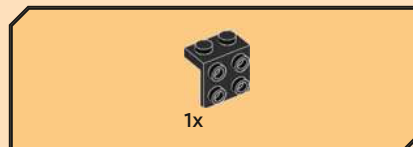
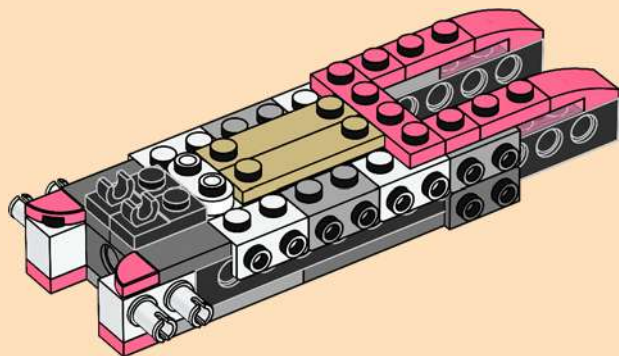

14

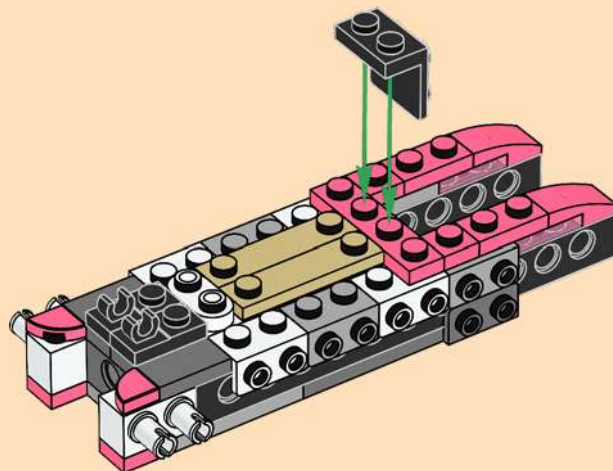

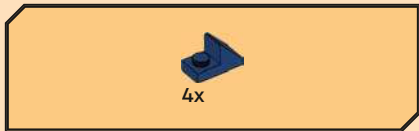

15

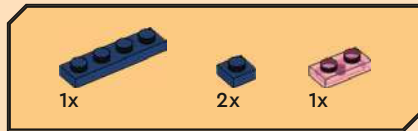
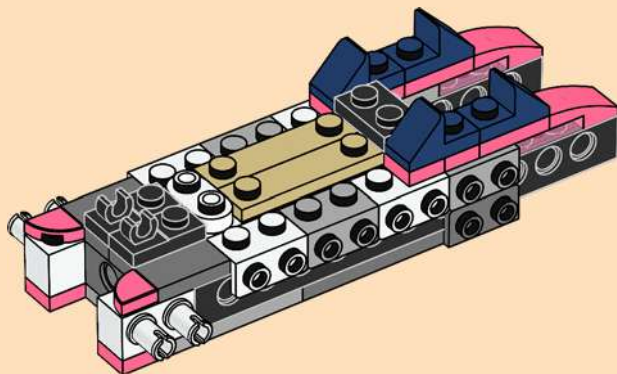

16

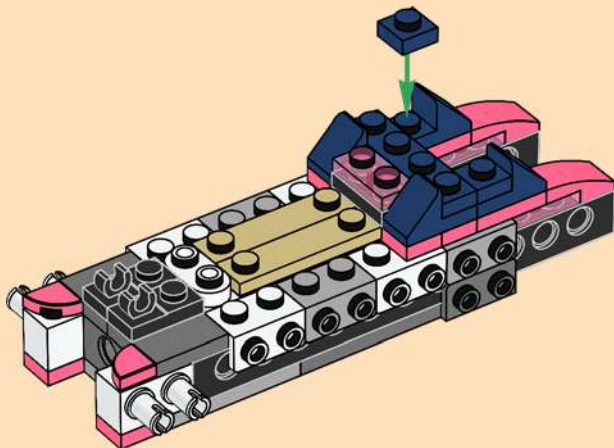



17

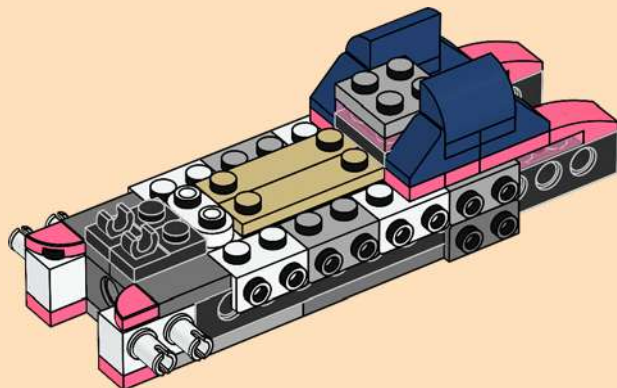

18

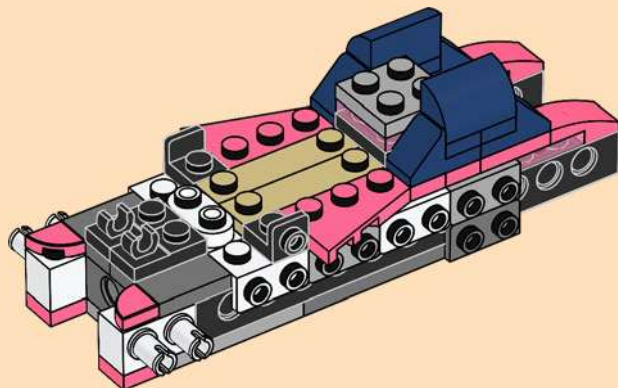

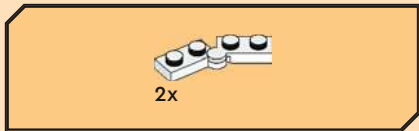

19

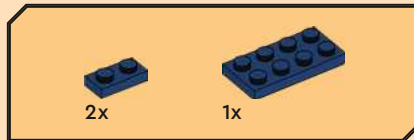
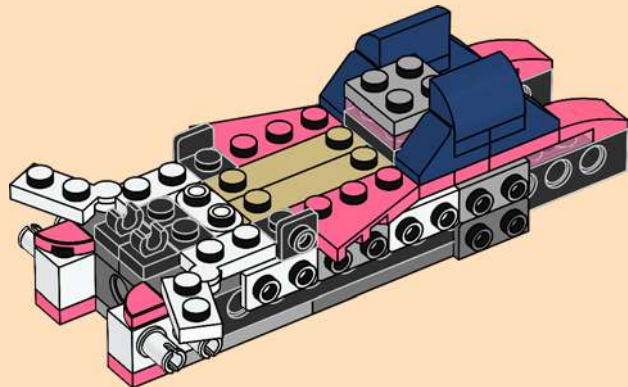

20

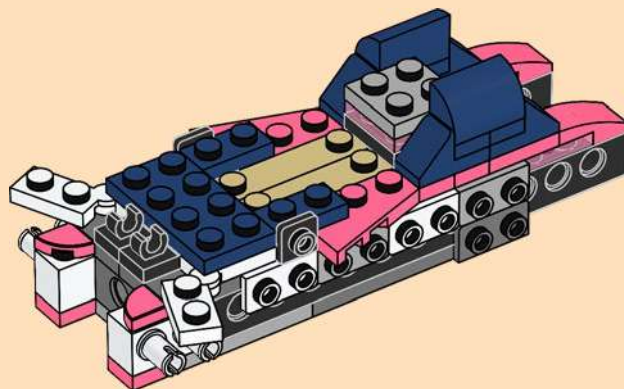



21

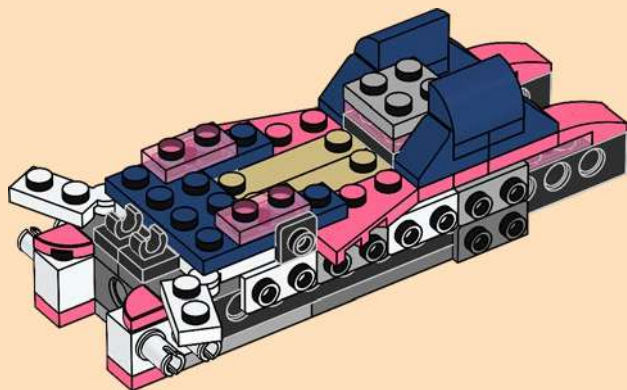

22

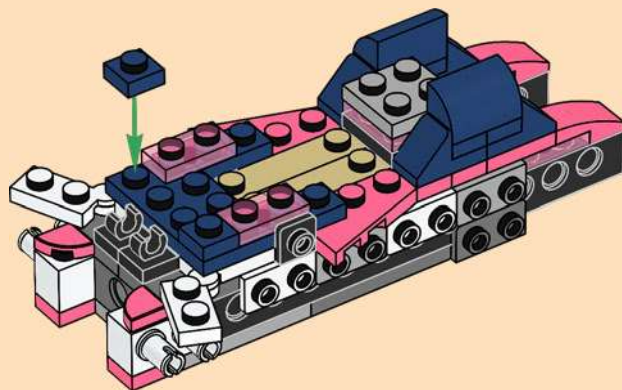

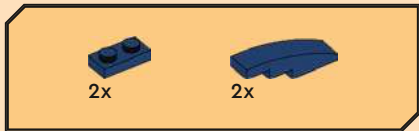

23

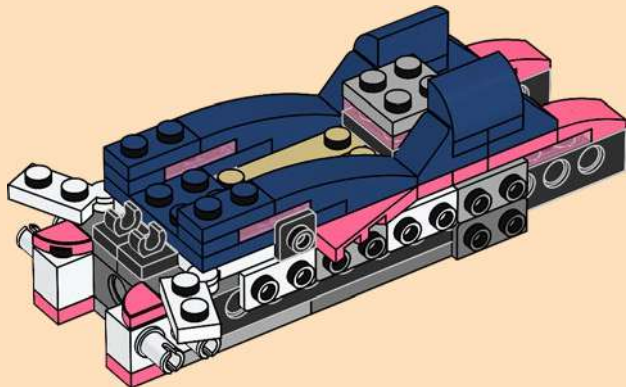

24

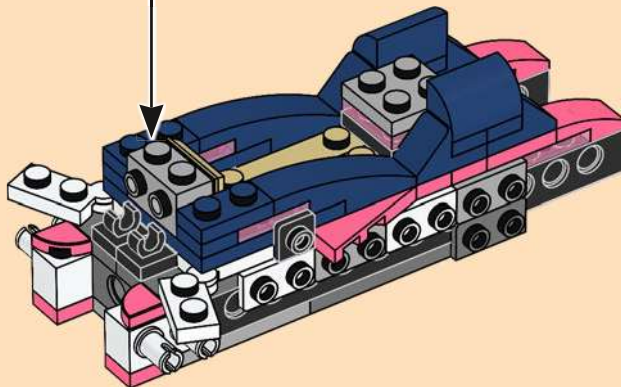
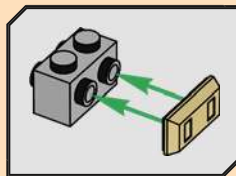

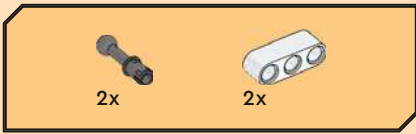

25

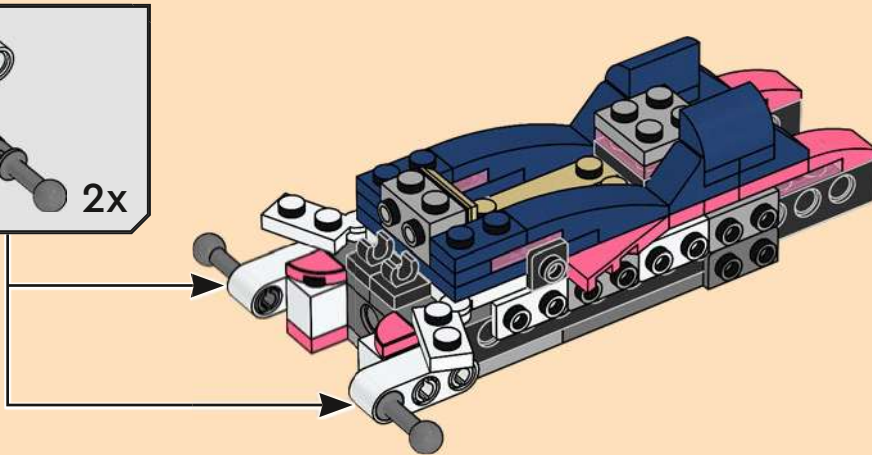
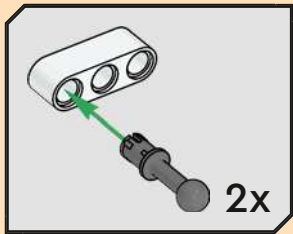

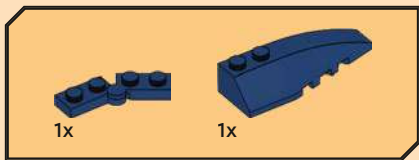

26

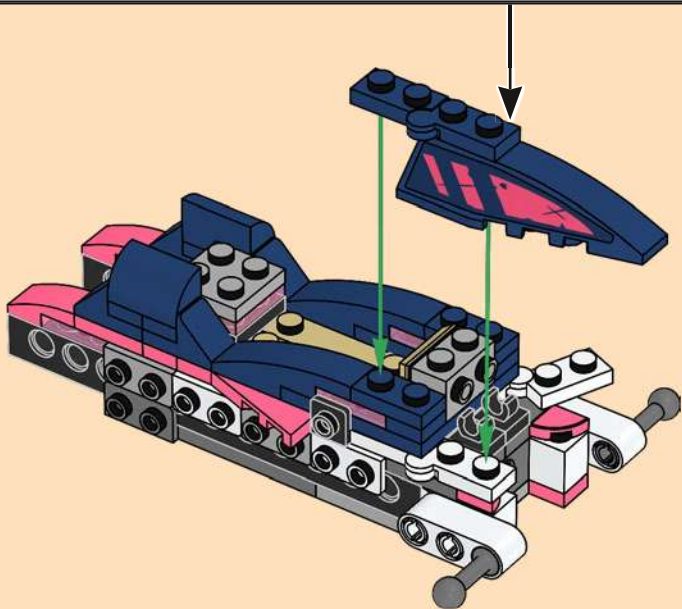
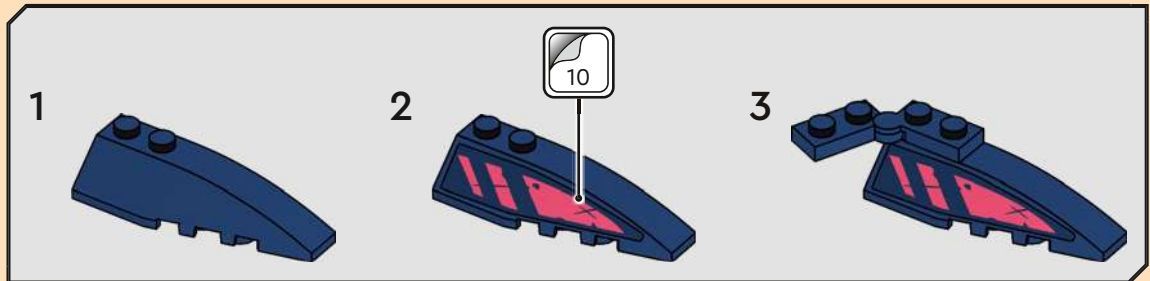



27

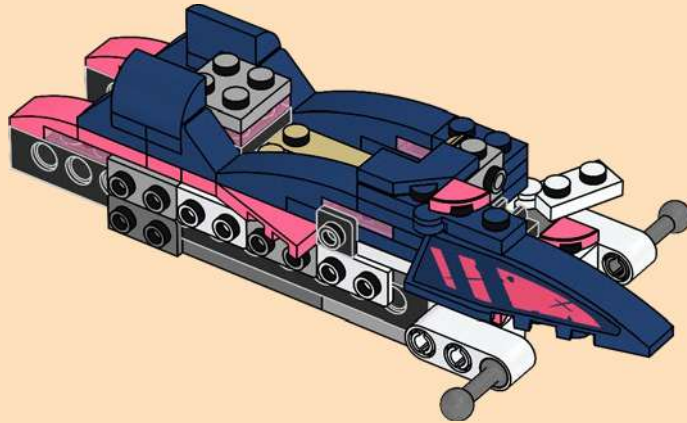

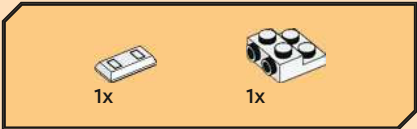

28

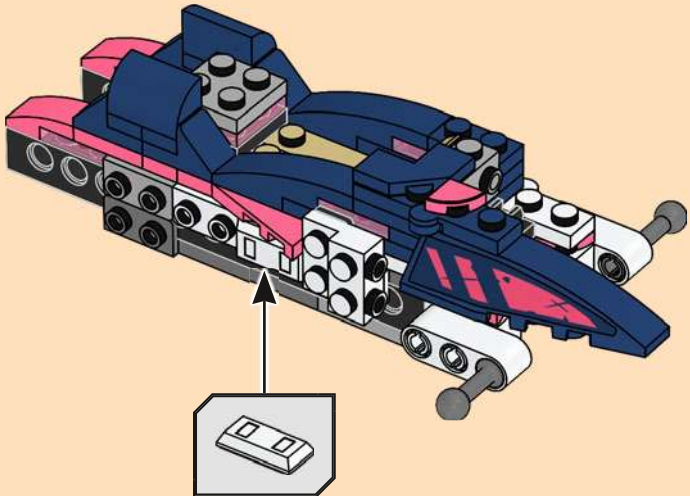

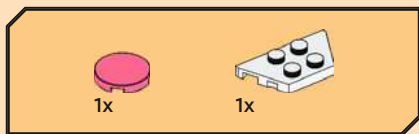

29

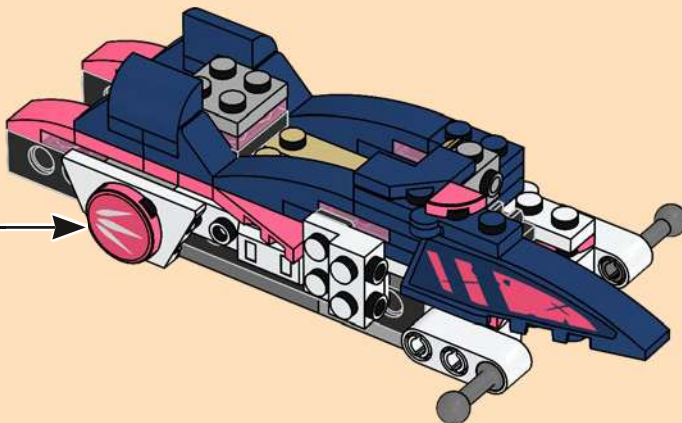
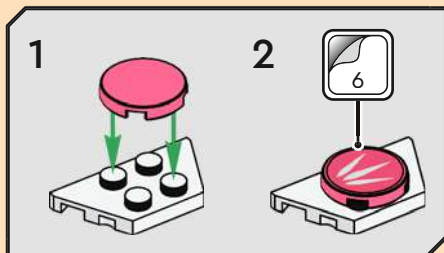

1x



1x



30

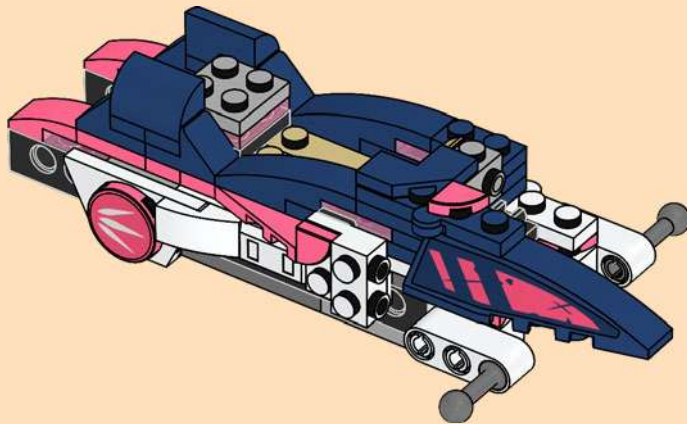

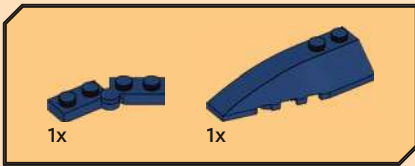

31

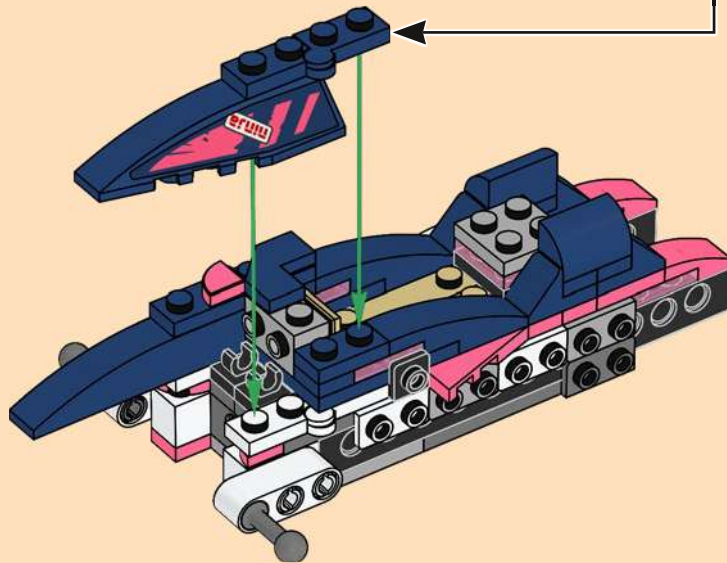
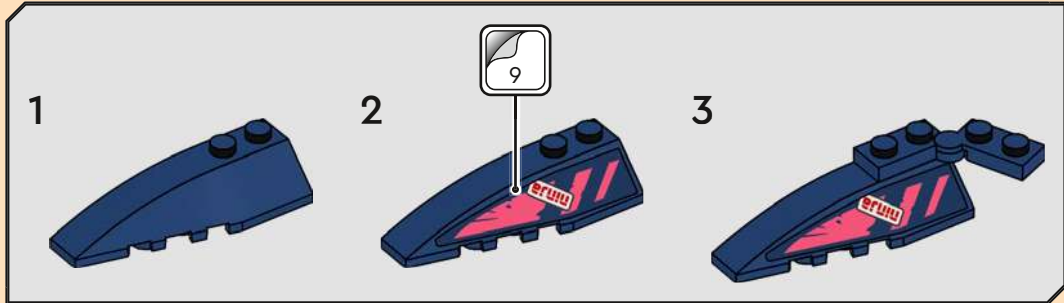

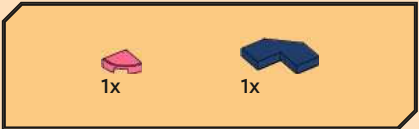

32

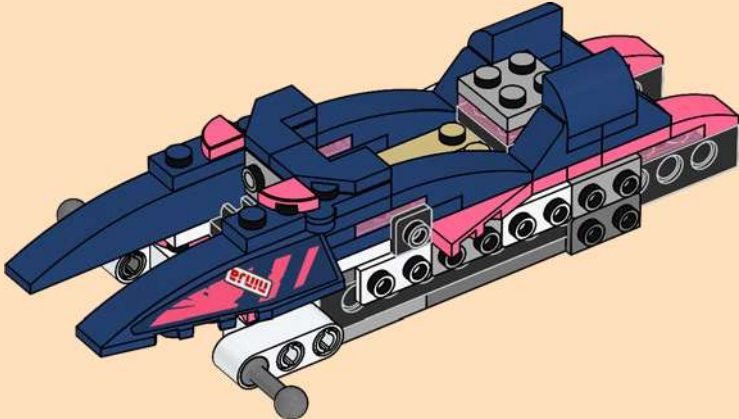

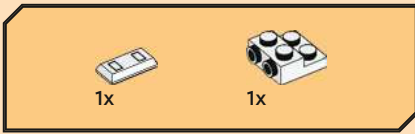

33

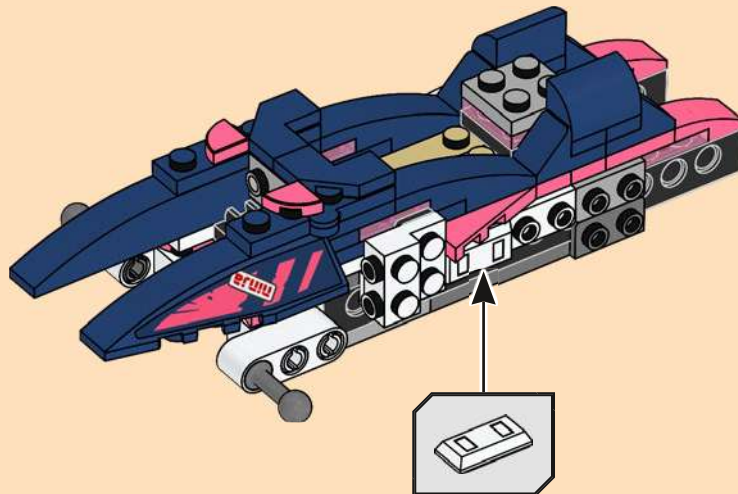

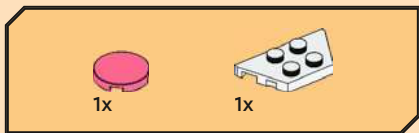

34

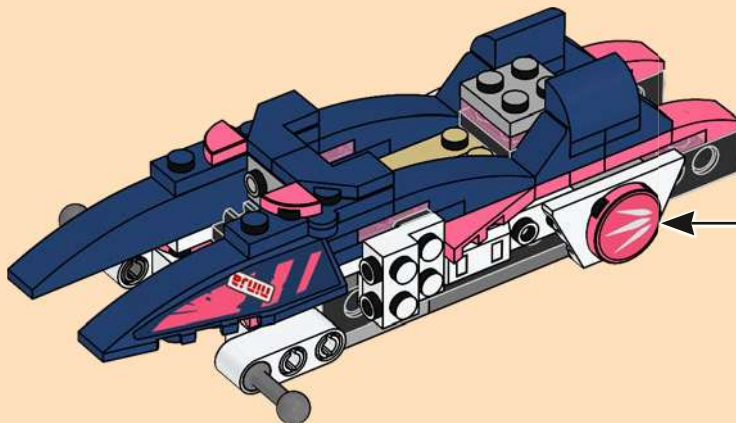
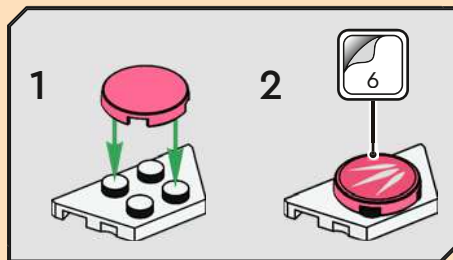

1x

1x

35

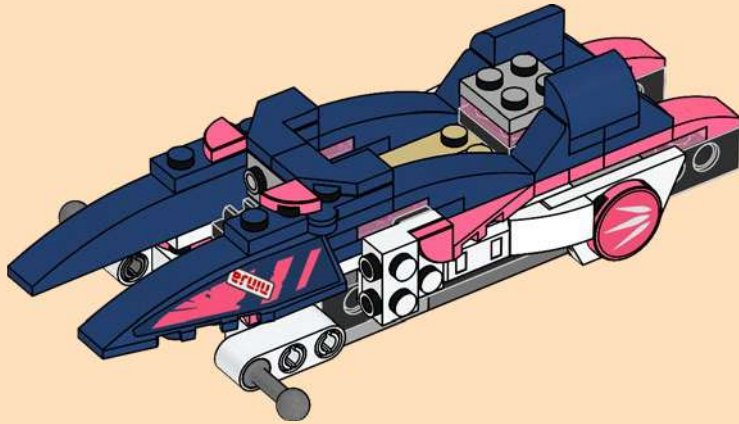

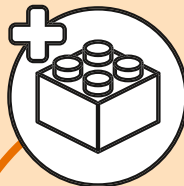

1x



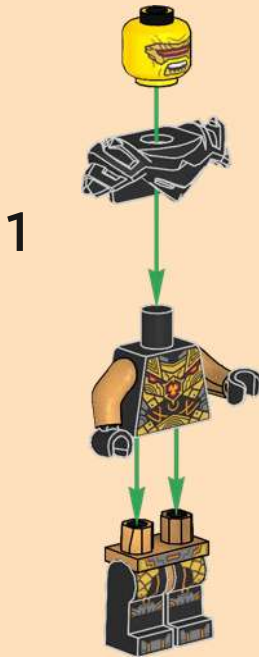
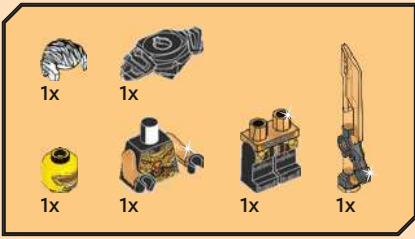

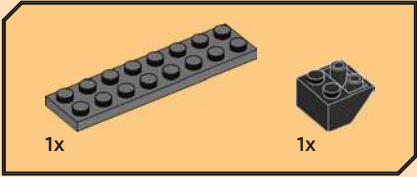
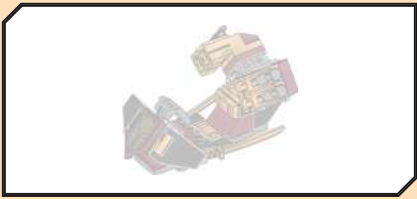

1

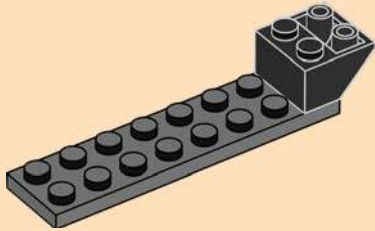

2

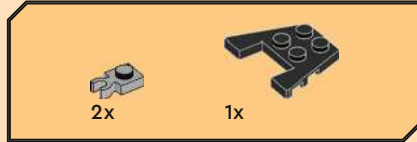
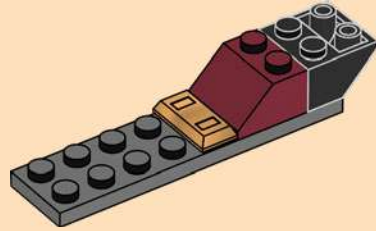

3



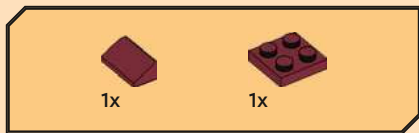

4

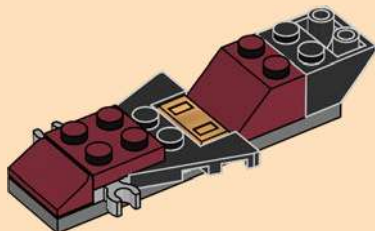

5

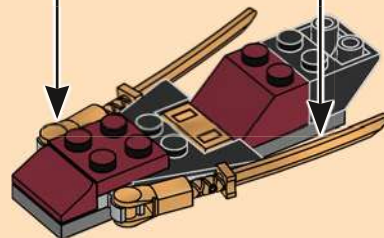
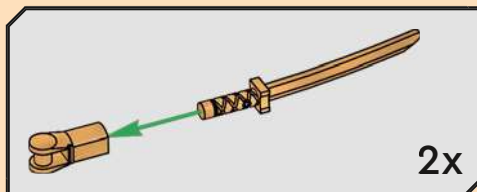



6

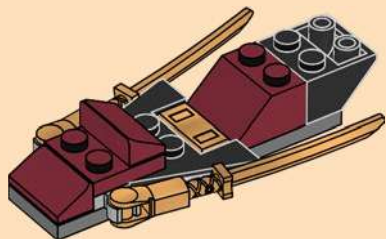

7

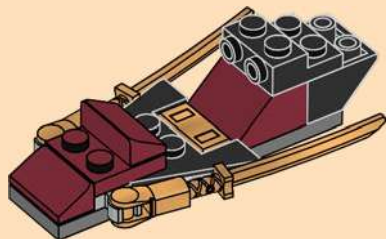



8

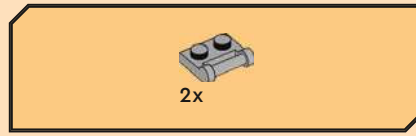
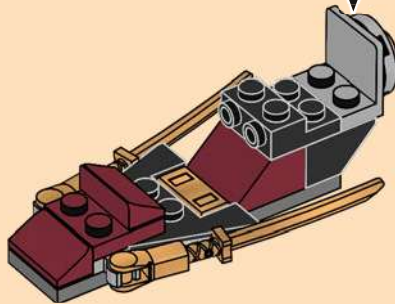
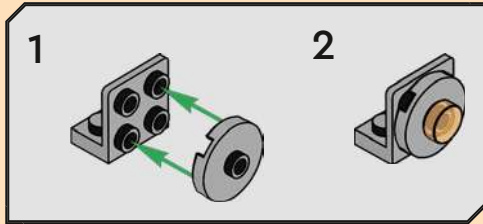

9

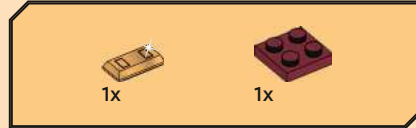
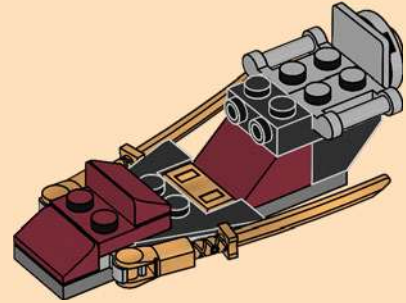

10

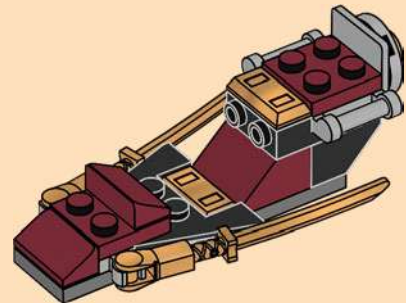

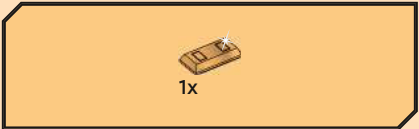

11

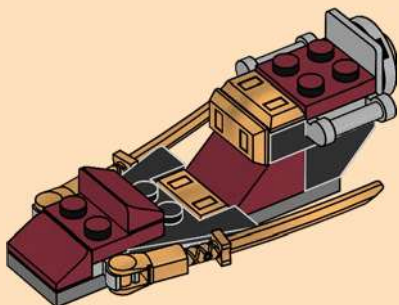

12

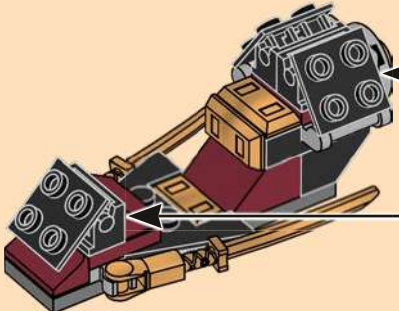
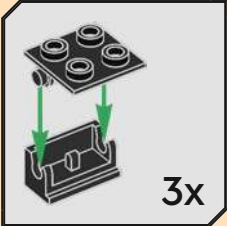



13

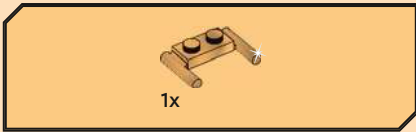

14



15

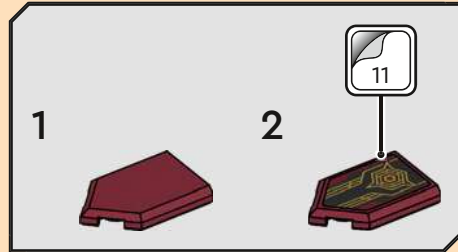



16



17



18

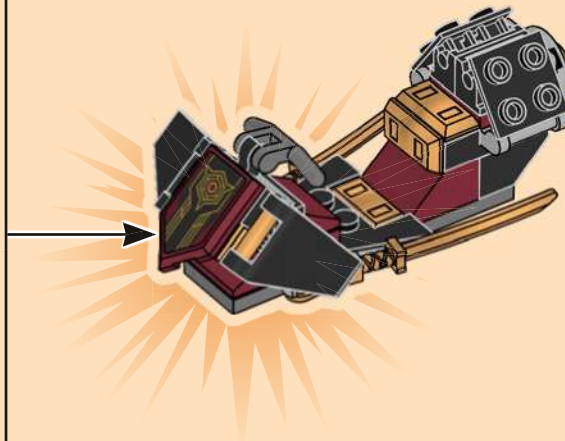

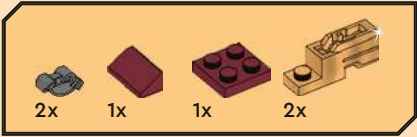
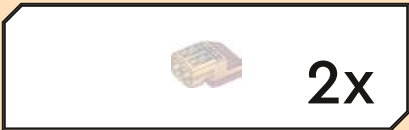

19

1



2

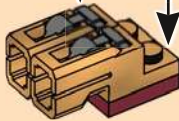

3



2x

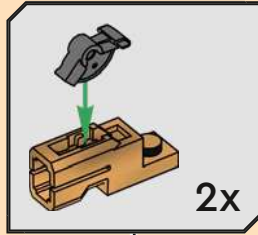

2x

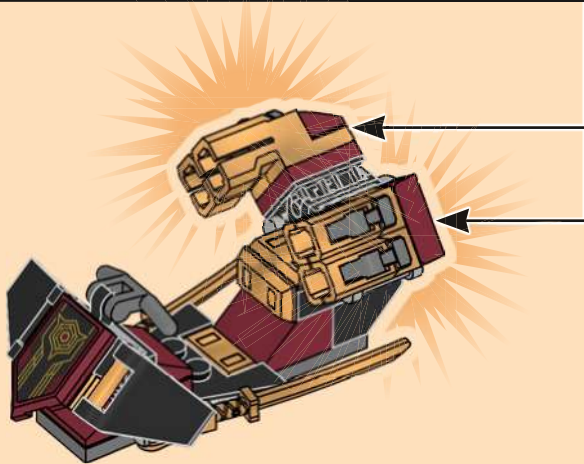

8x

20



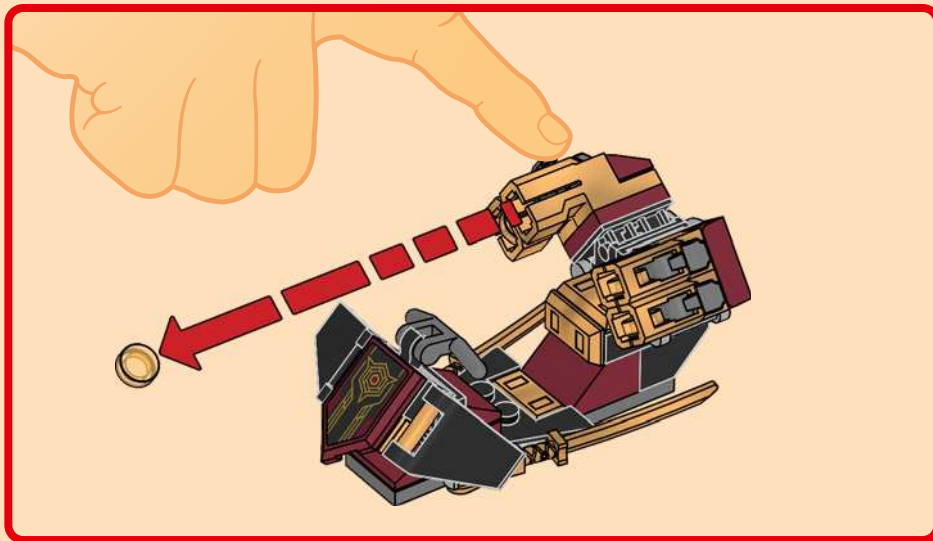

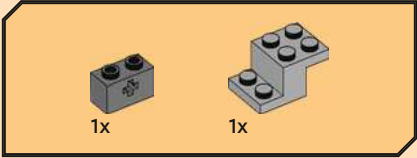

36

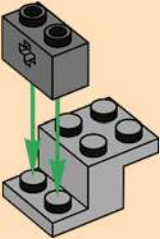

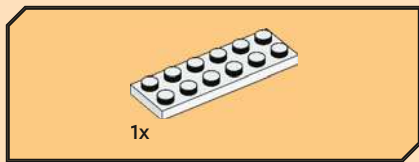

37

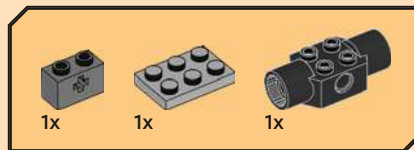

38

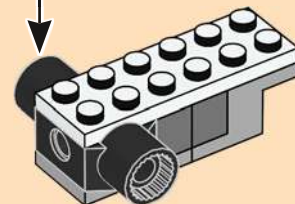
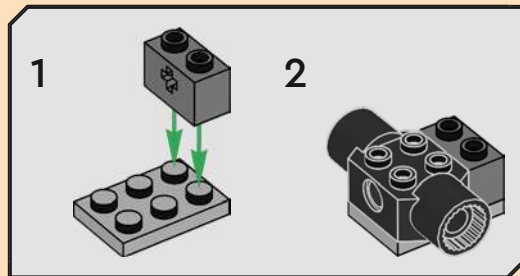

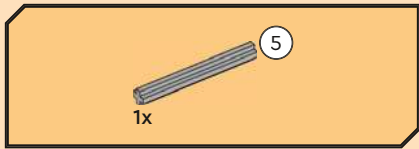

39

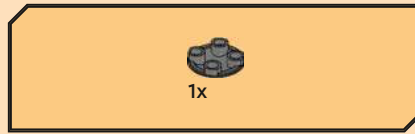
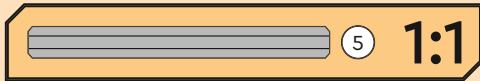
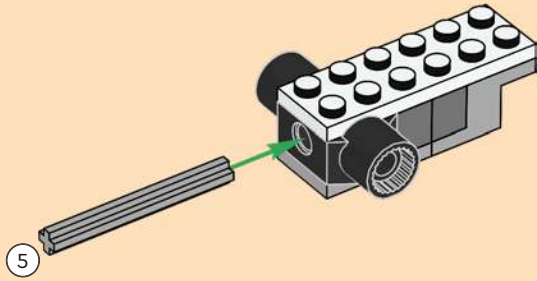

40

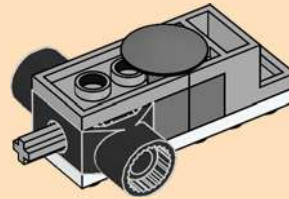



41

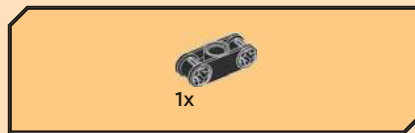

42

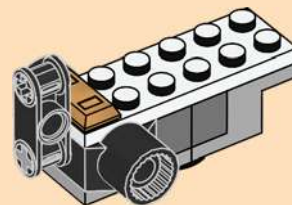



1x

43

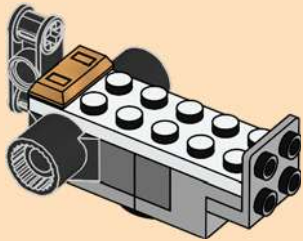

44

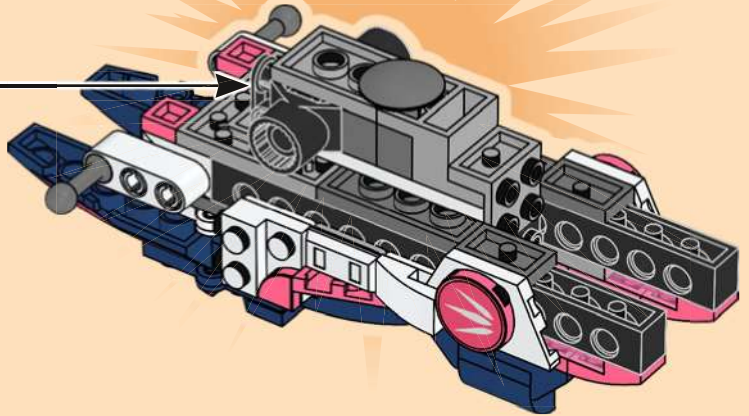

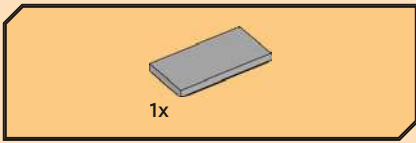

45

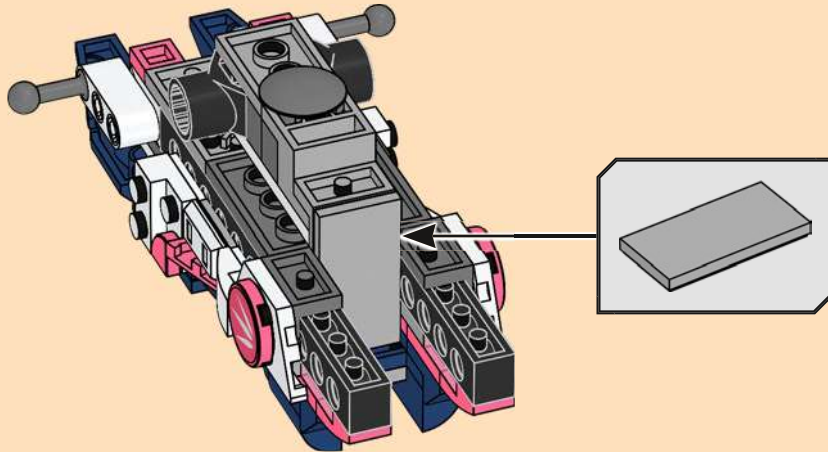

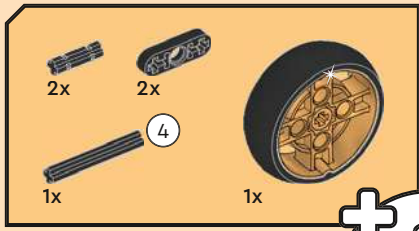

46

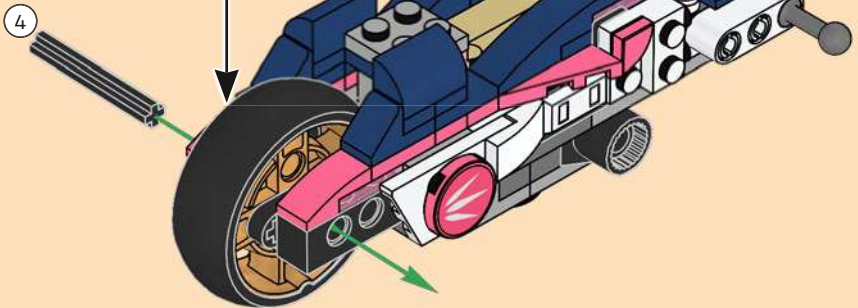
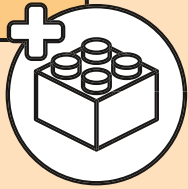

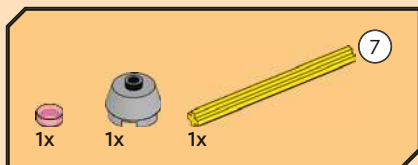

47

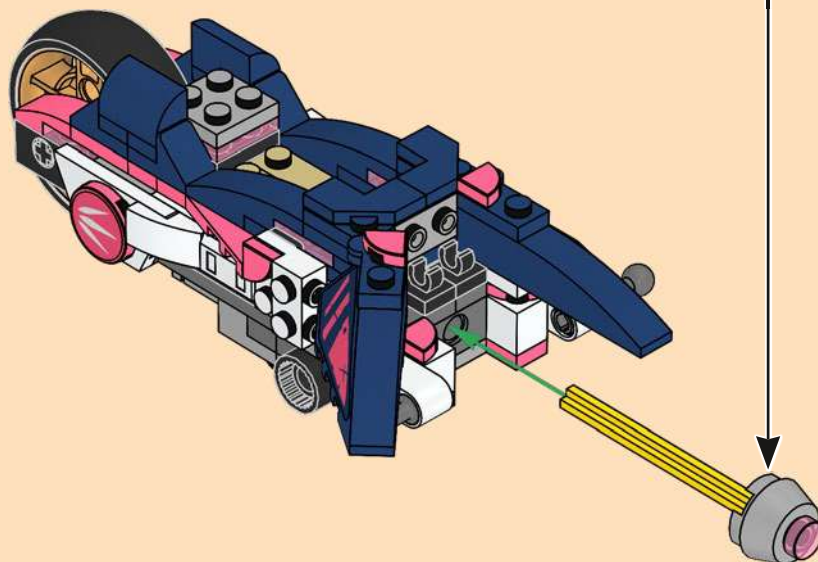
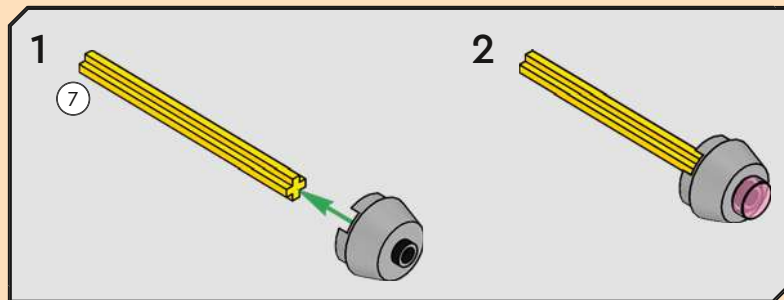

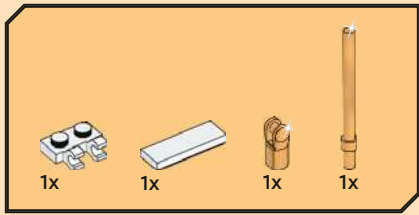

48

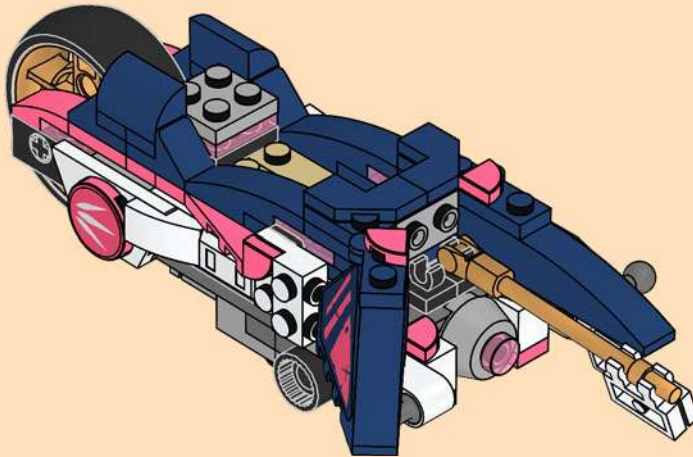
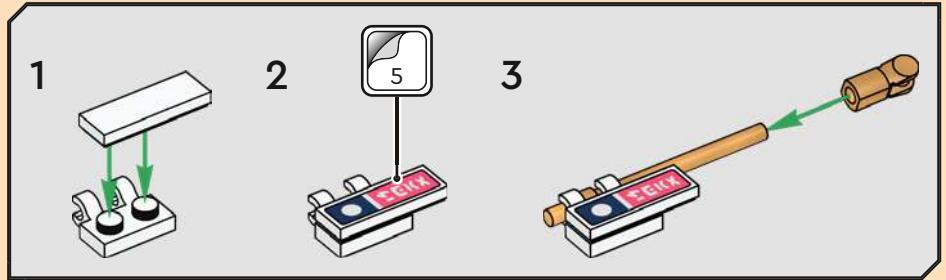

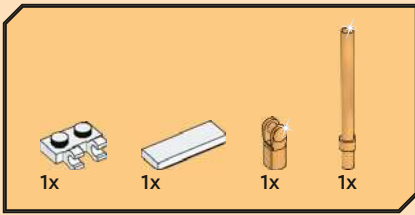

49

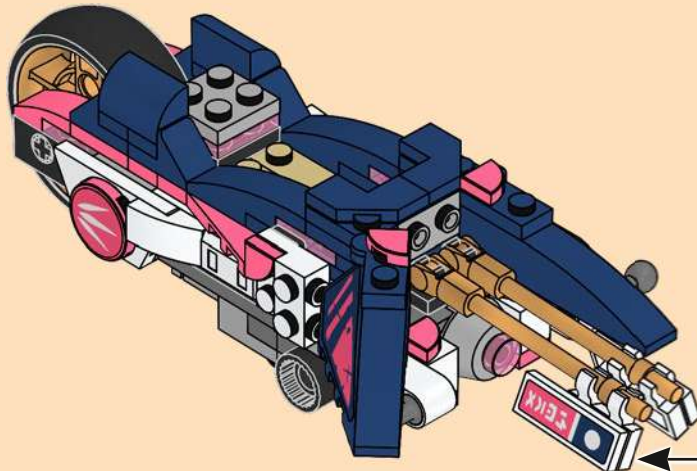
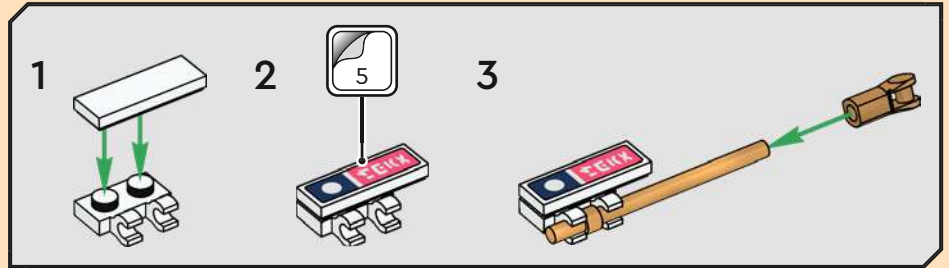

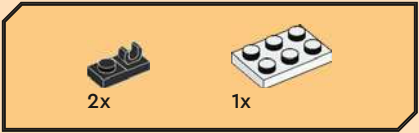

50

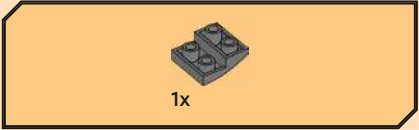
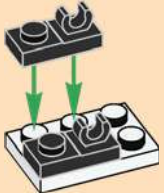

51



52



53

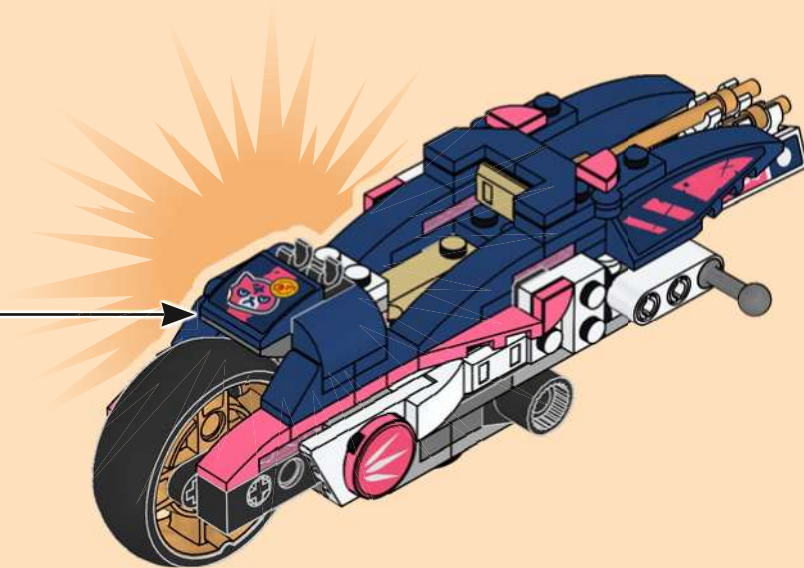

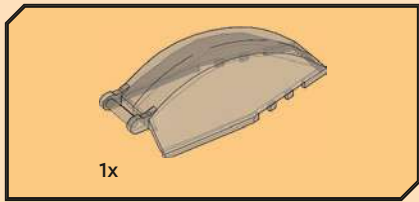

54



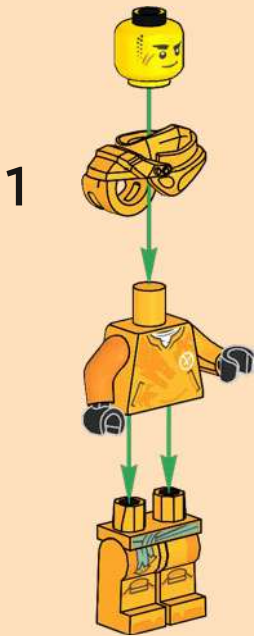
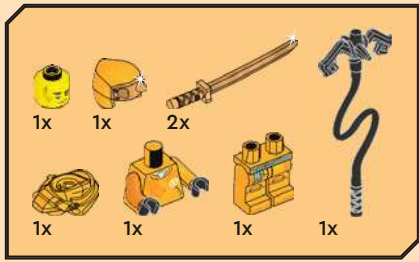

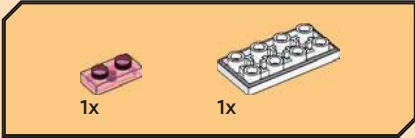

55

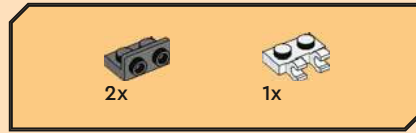

56



57





58

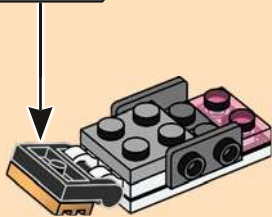
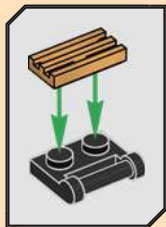

59

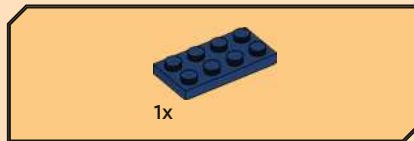
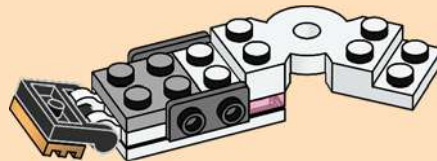

60



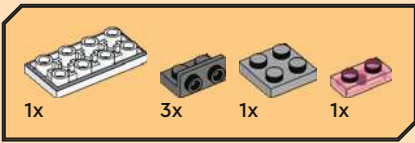

61

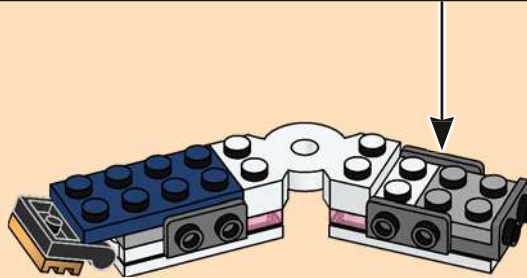
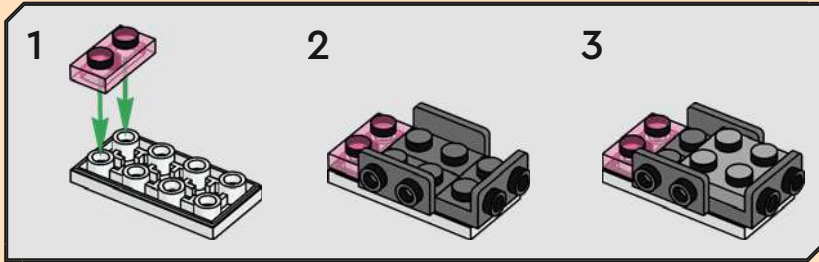

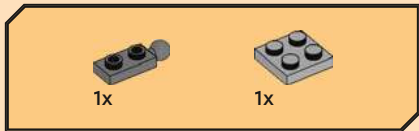

62

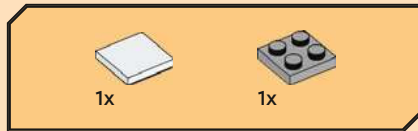

63

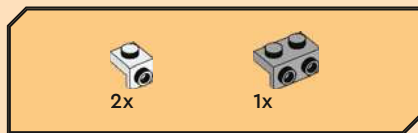

64

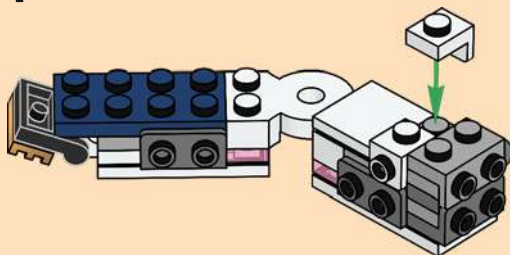

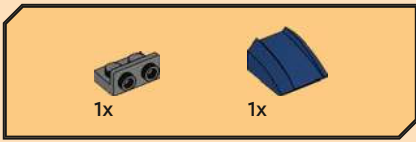

65

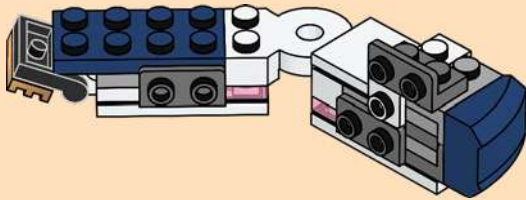

66

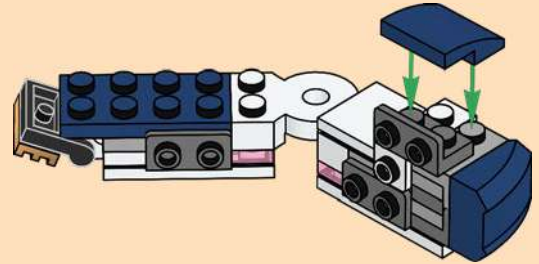



67

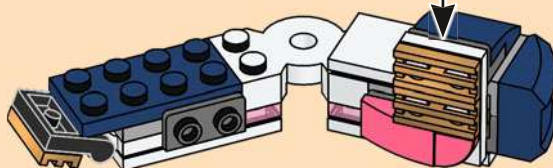
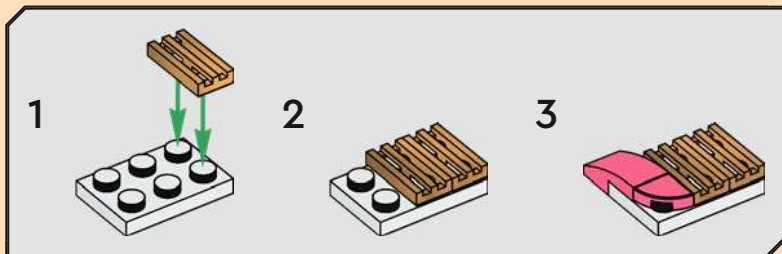

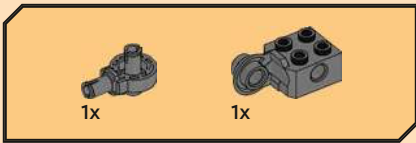

68

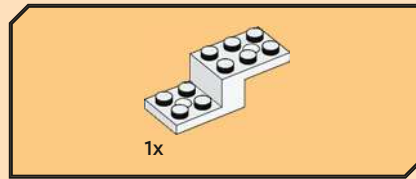
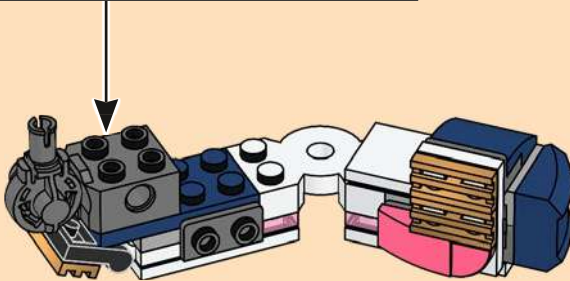
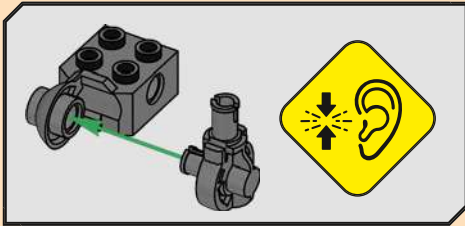

69

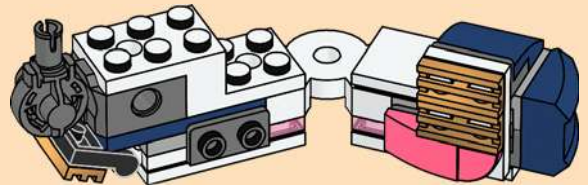

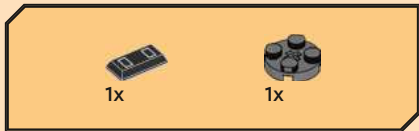

70

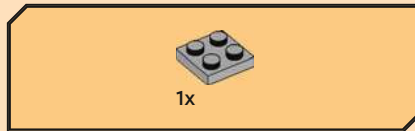
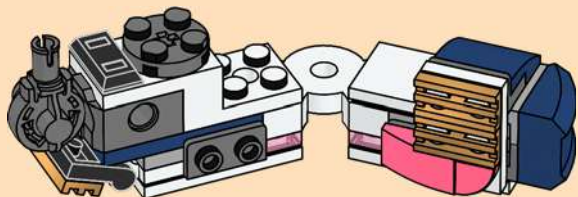

71

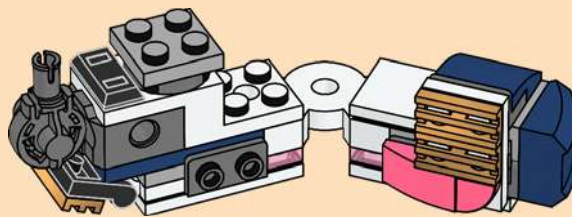

72

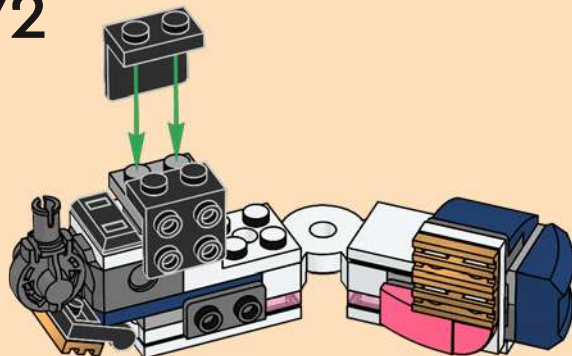



73

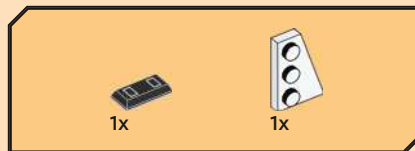
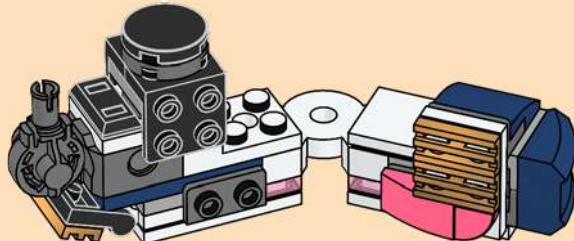
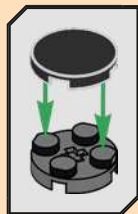

74

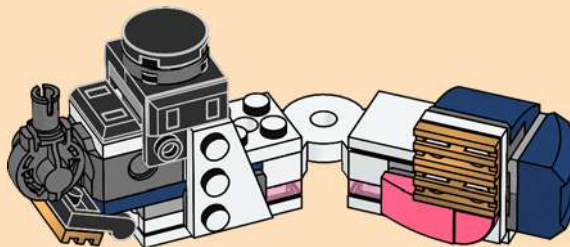

75

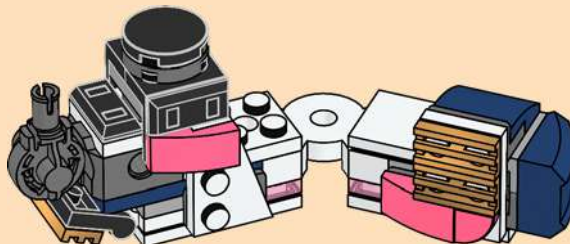

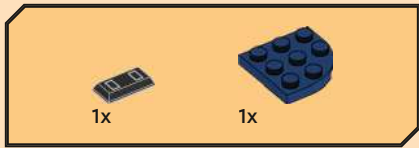

76

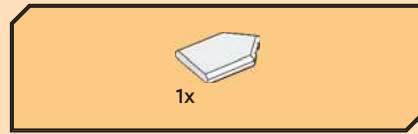

77

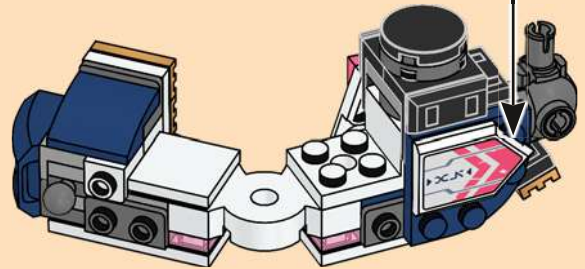
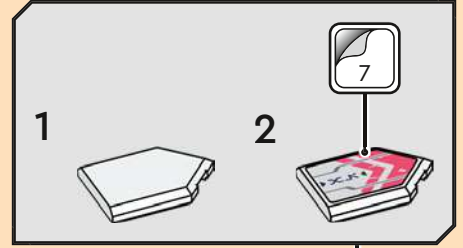



78

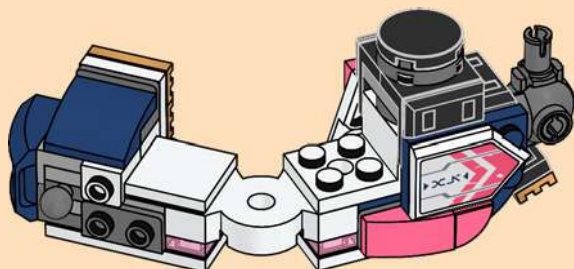

79

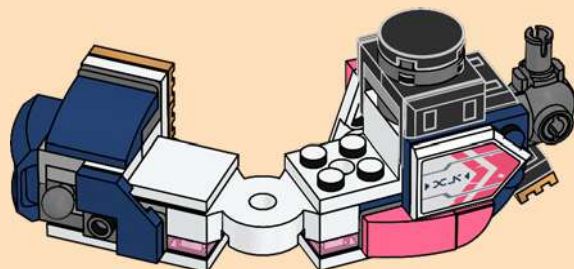

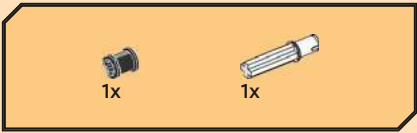

80

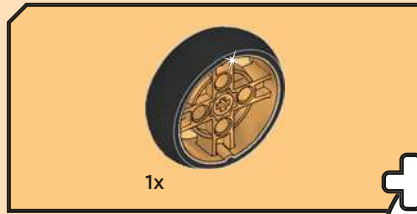
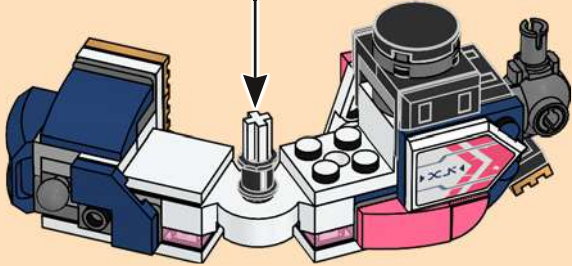
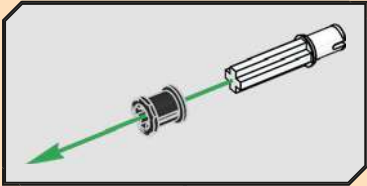

81

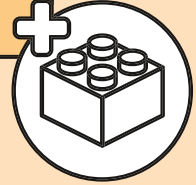

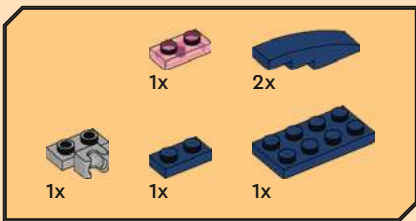

82

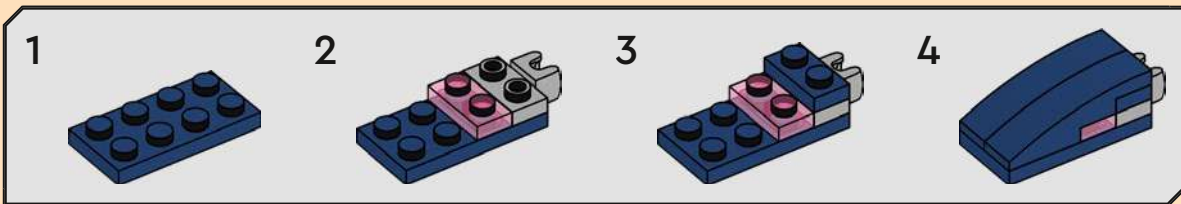

83

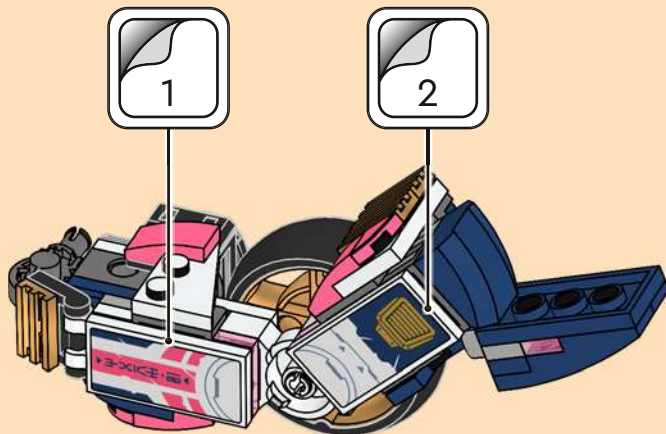

84

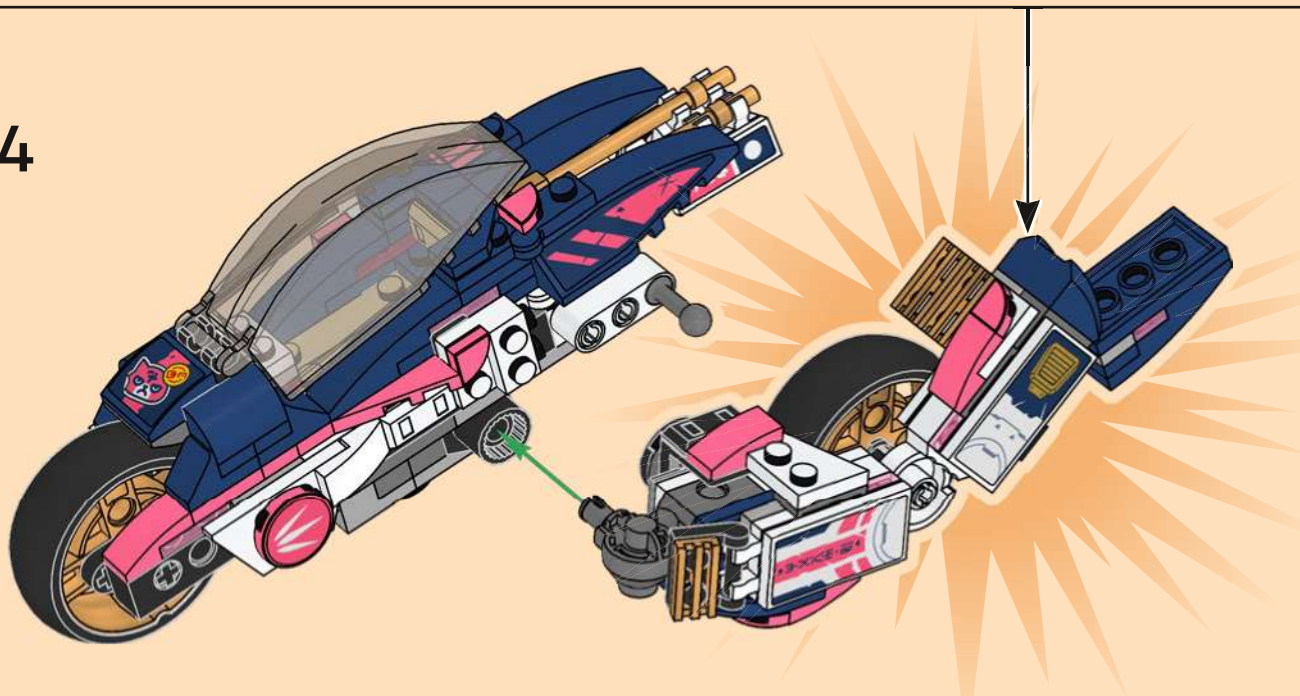

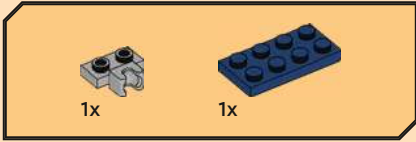

85

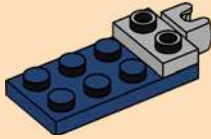

86

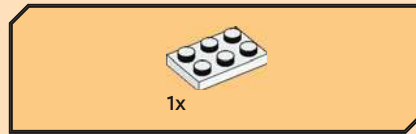

87



88



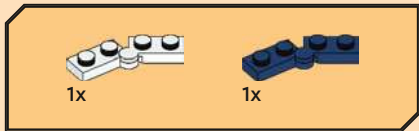

89

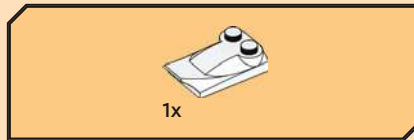
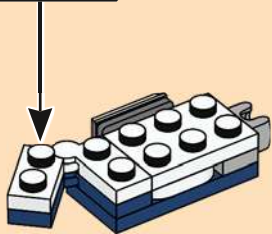
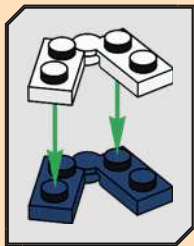

90

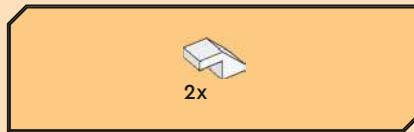

91

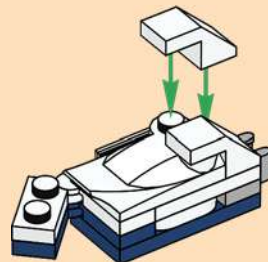

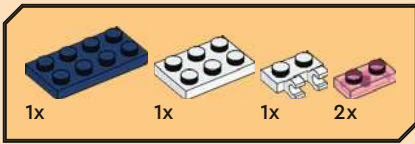

92

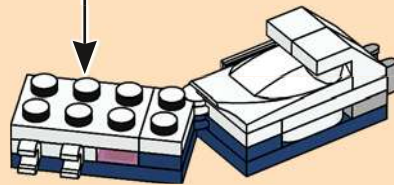



93

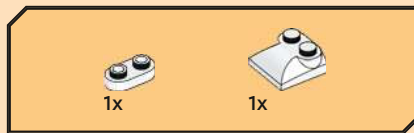
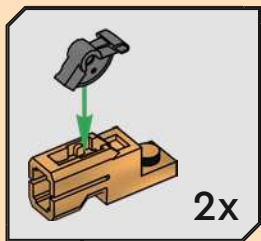

94





95

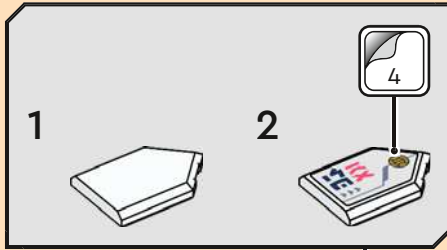

96

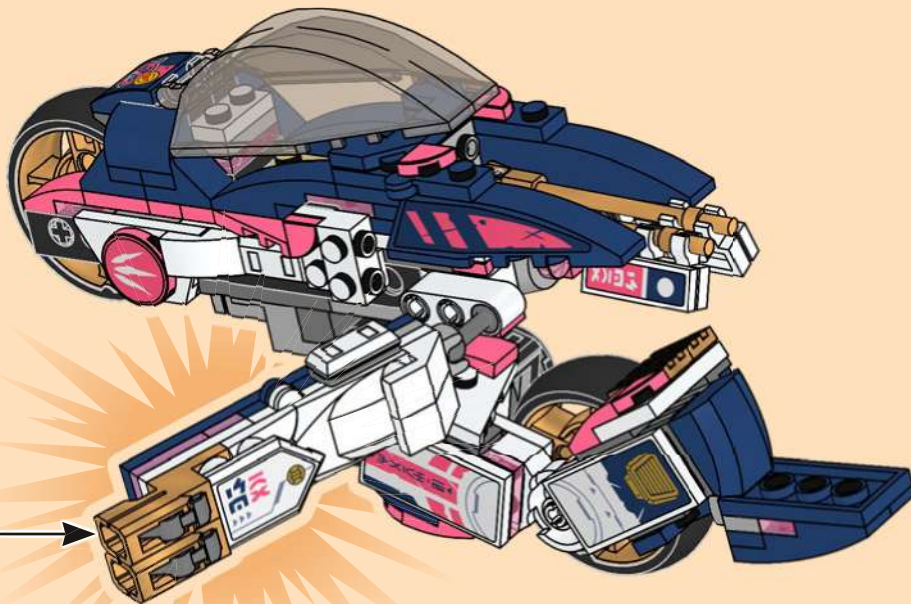

97

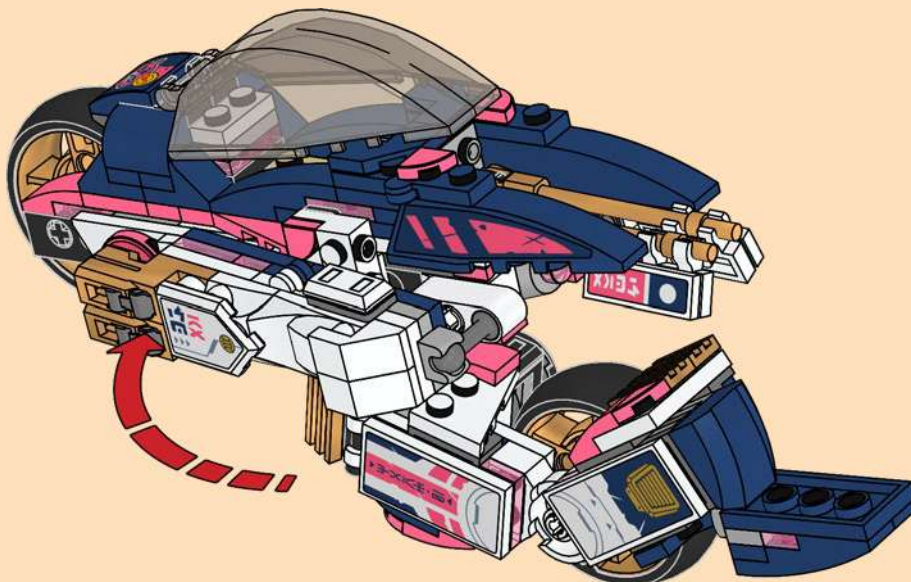

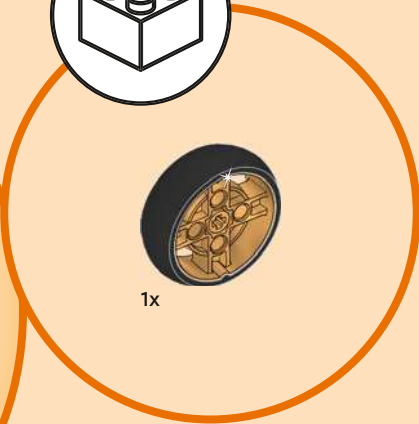
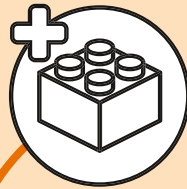

1x



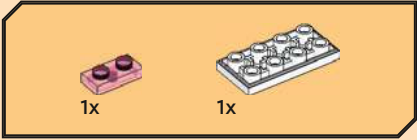
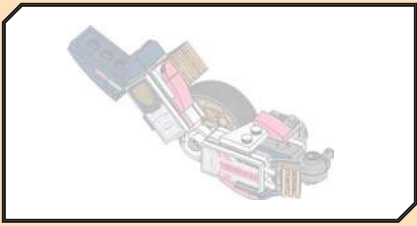

98

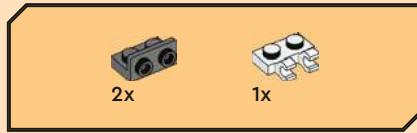

99



100





101

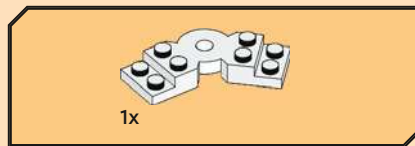
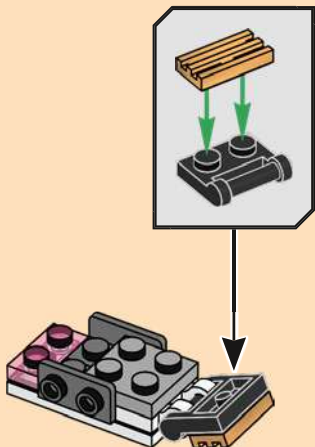

102

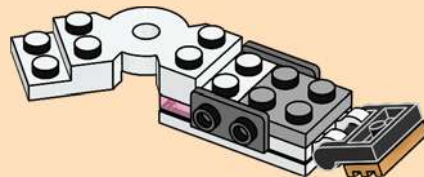

103

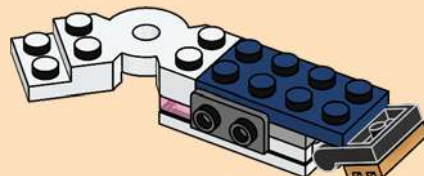



104

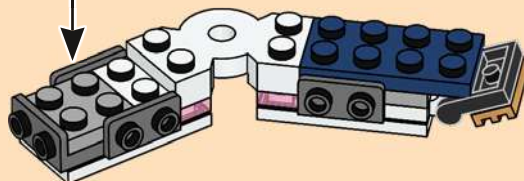
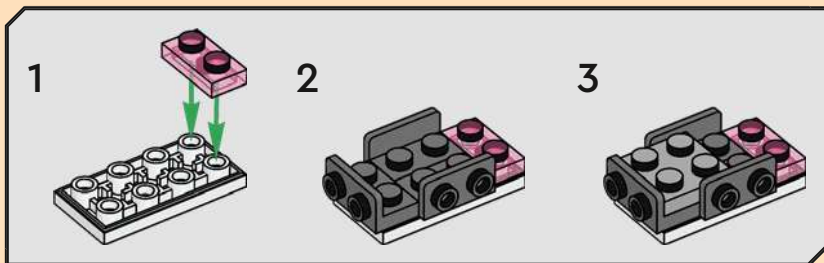

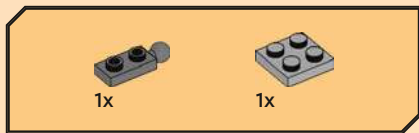

105

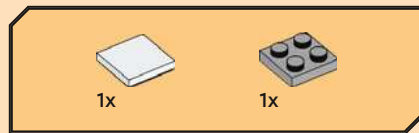
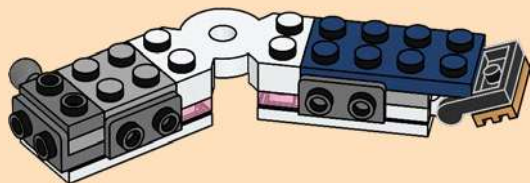

106

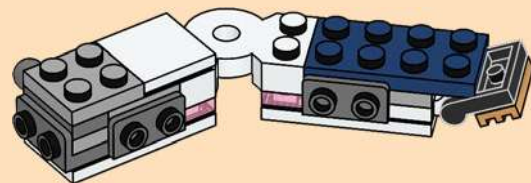

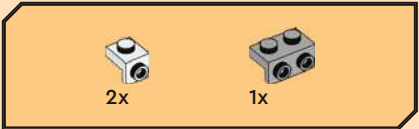

107

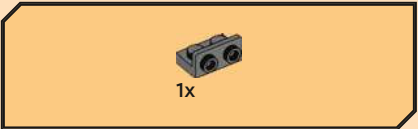
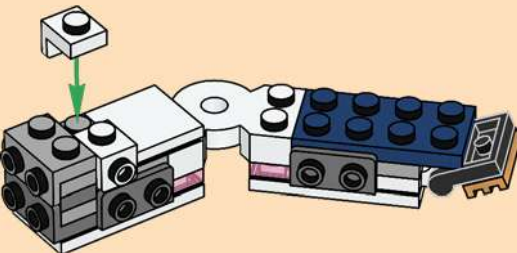

108

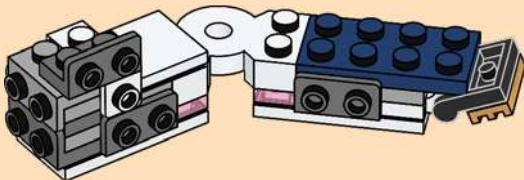

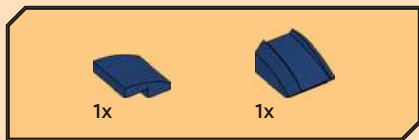

109

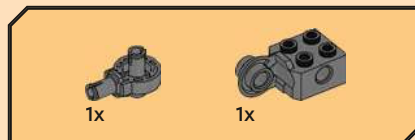
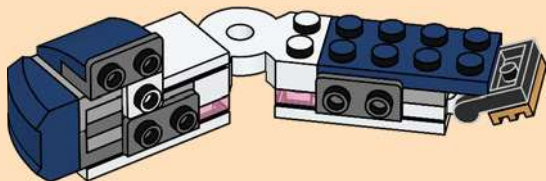

110

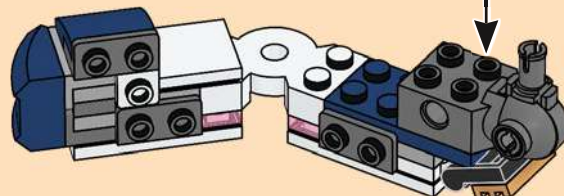
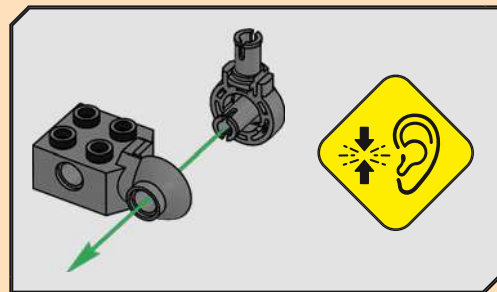

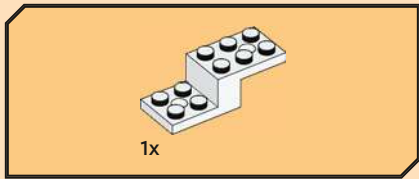

111

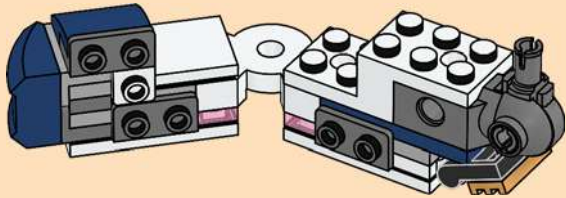

112

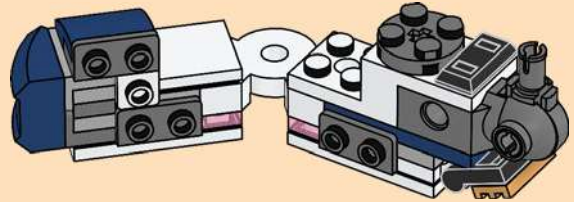



113

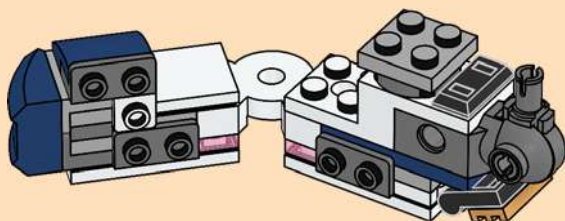

114

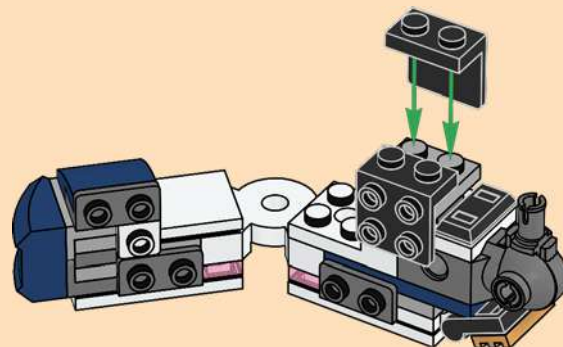



115

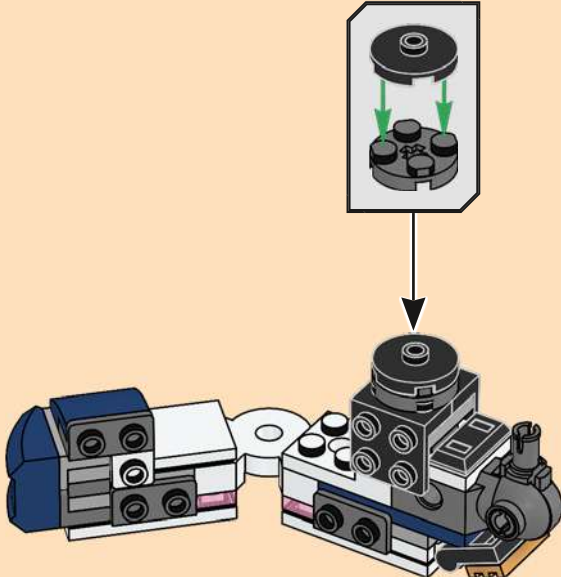

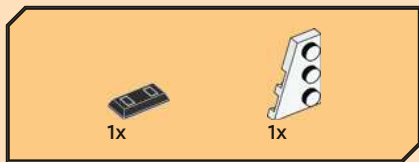

116

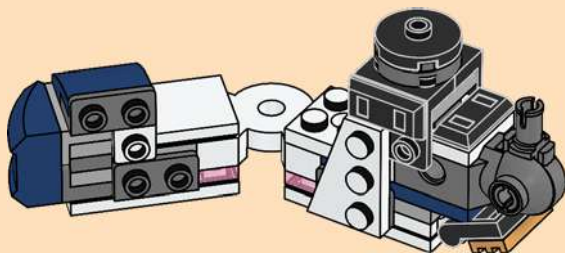

117

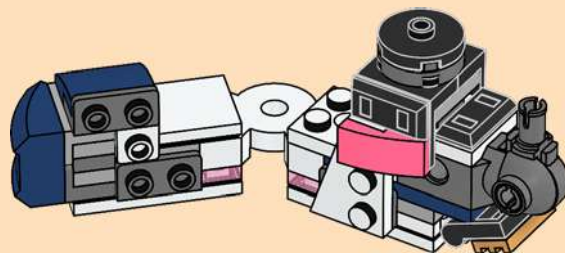

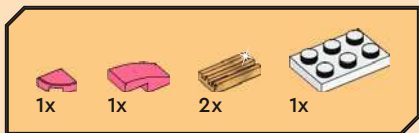

118

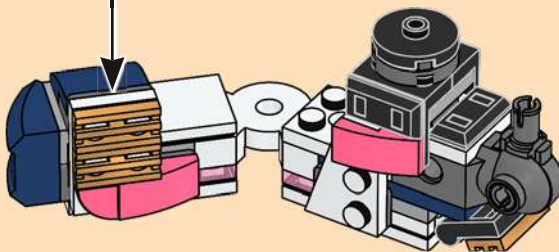



119



120

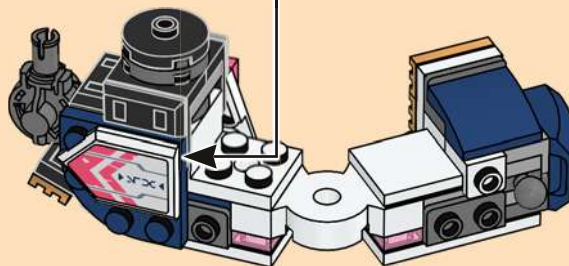
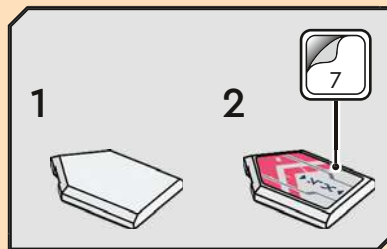

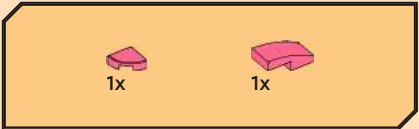

121

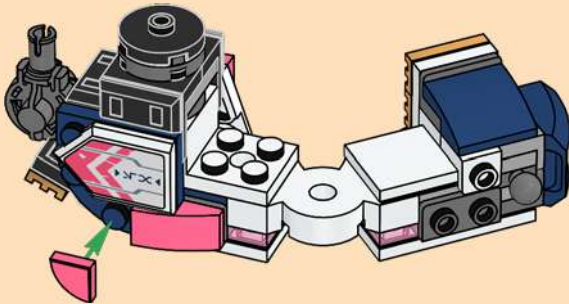

122



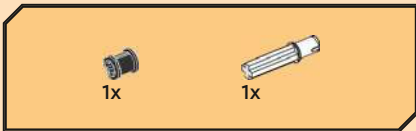

123

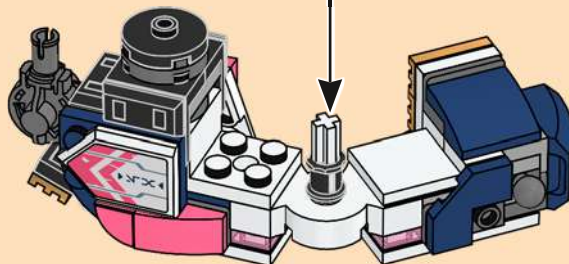
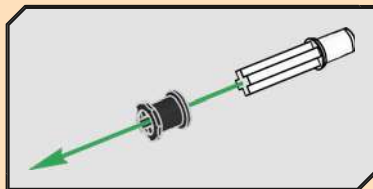

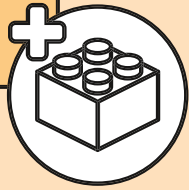
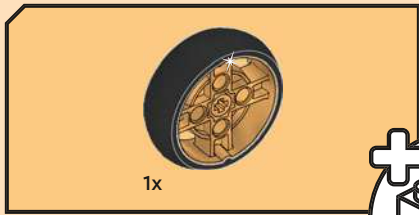

124



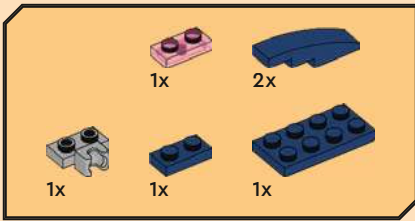

125

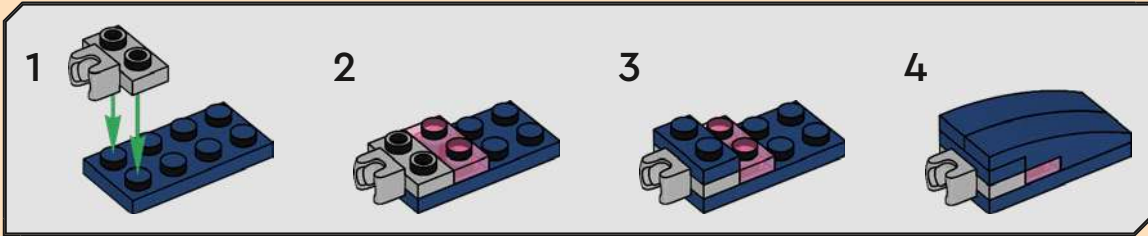

126

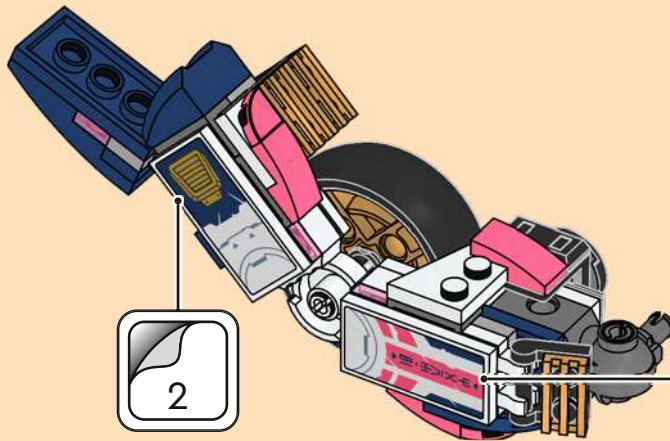
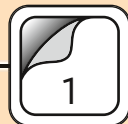

127

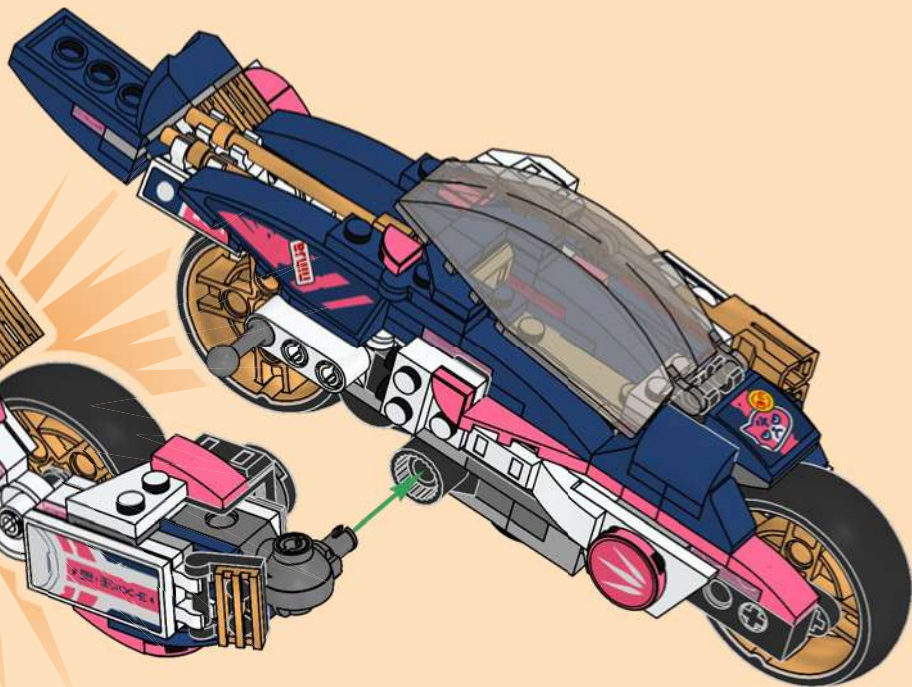
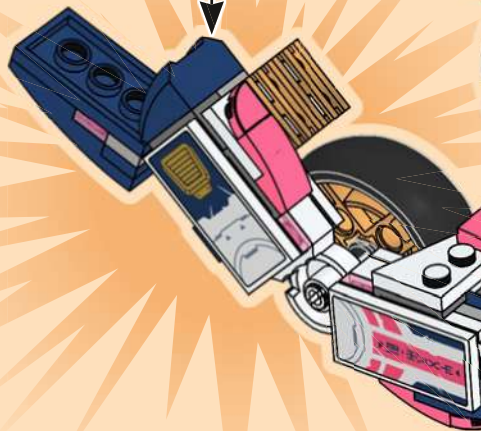

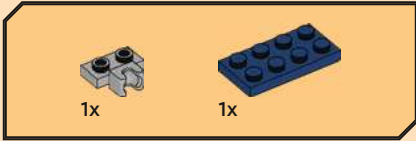

128

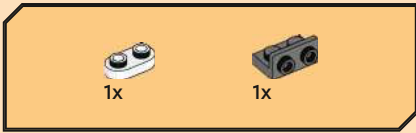
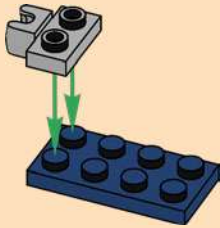

129

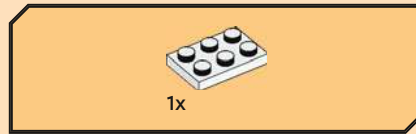

130

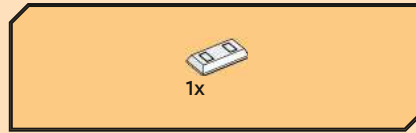

131



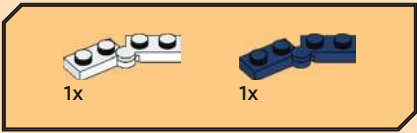

132

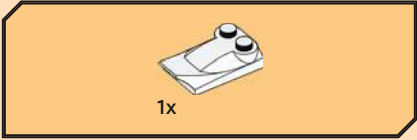
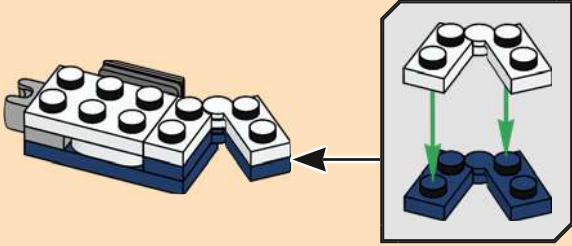

133

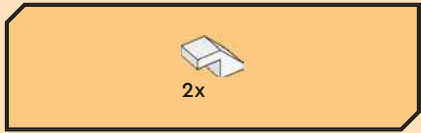

134

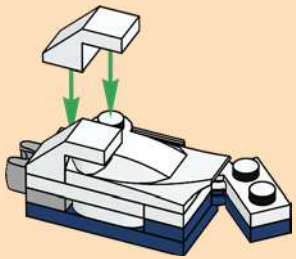

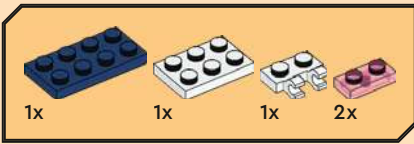

135

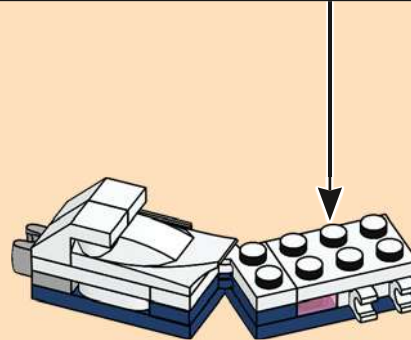

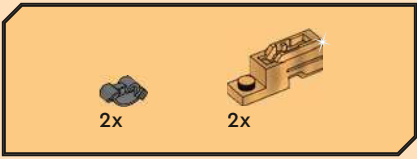

136

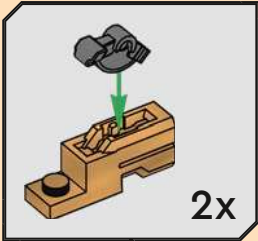

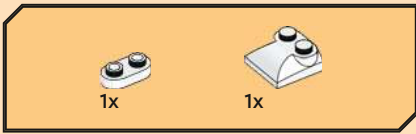

137

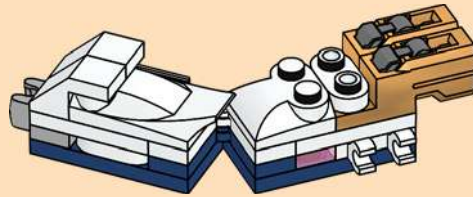



138

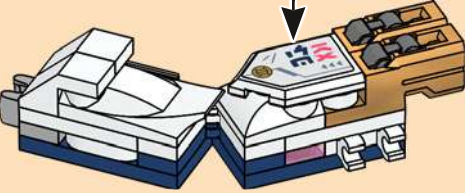
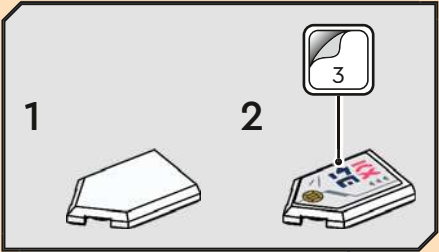

139

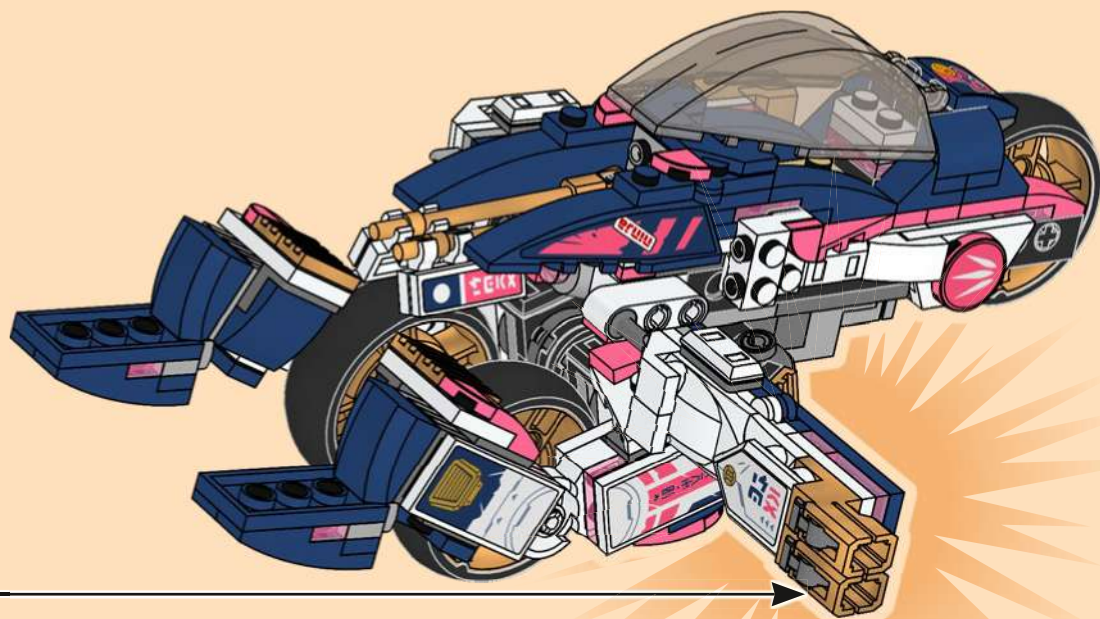

140

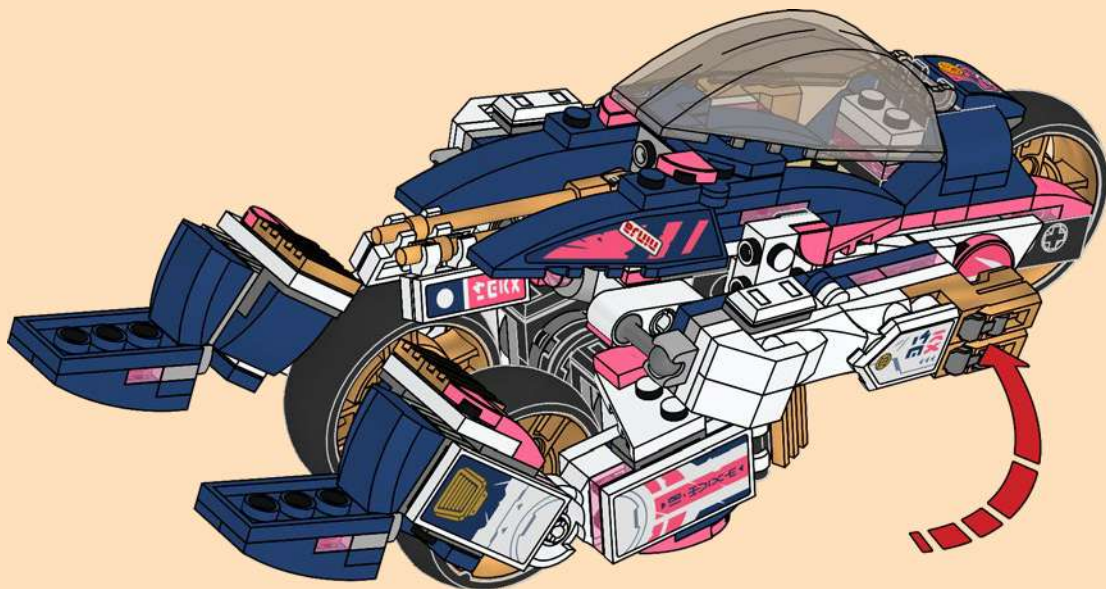

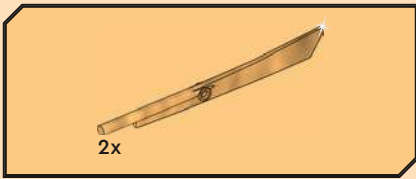

141

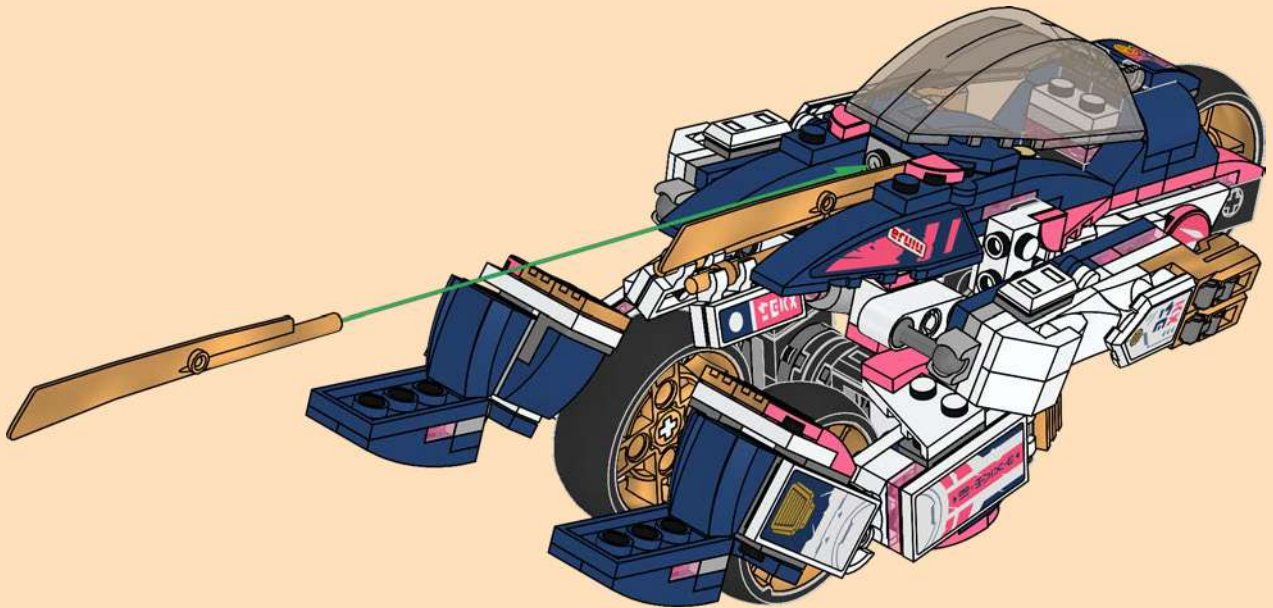

8x

142

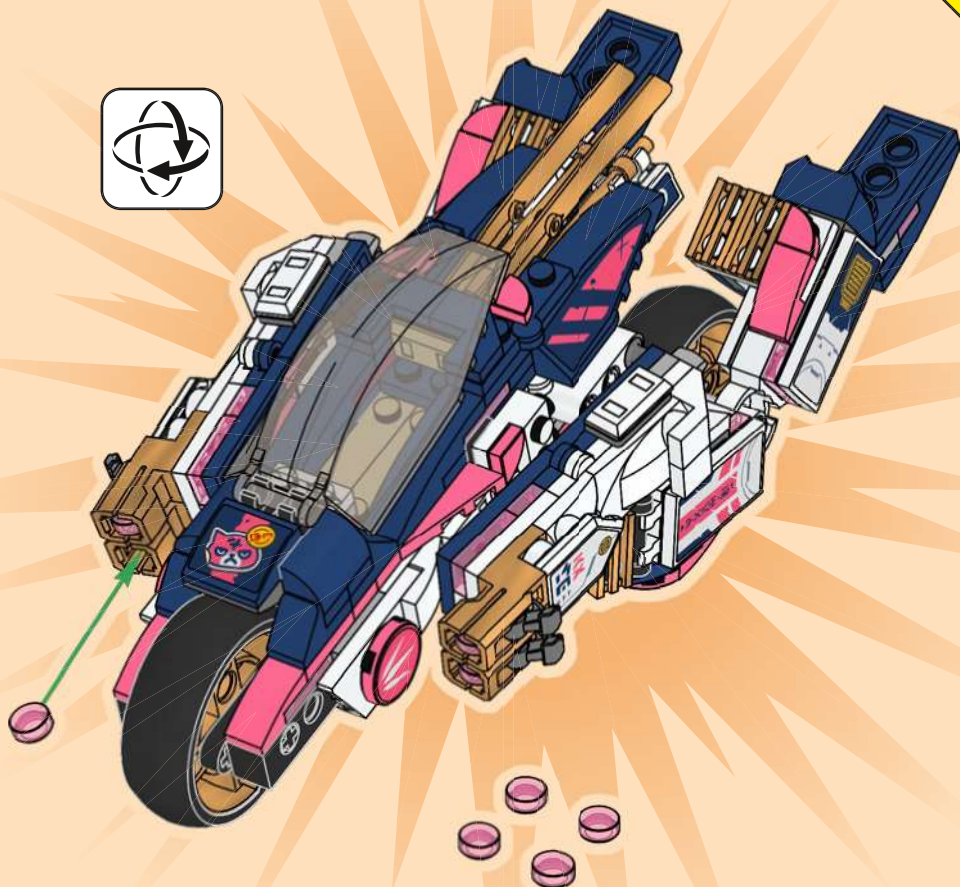

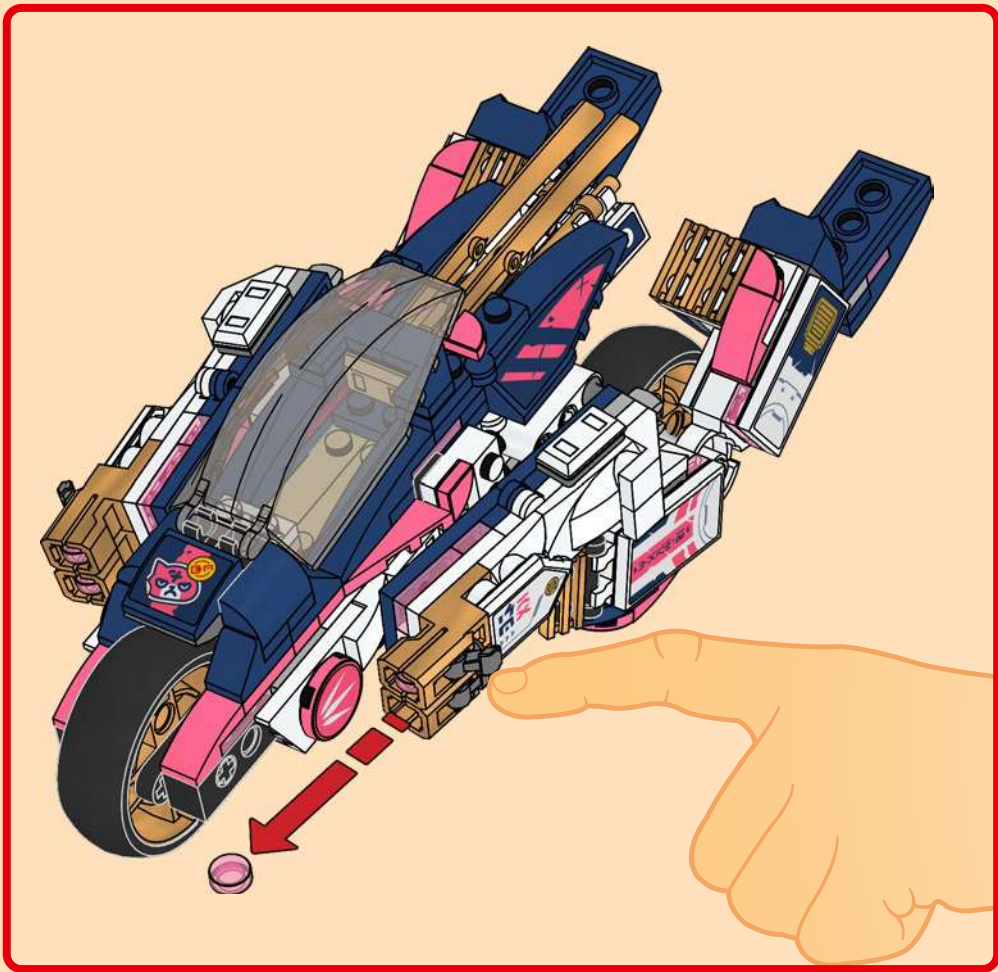

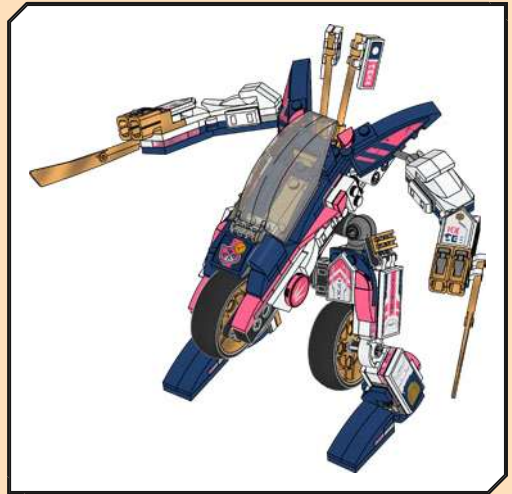
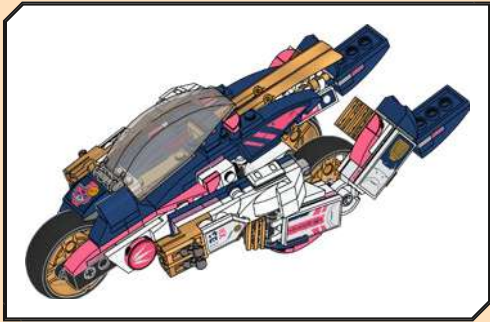

1

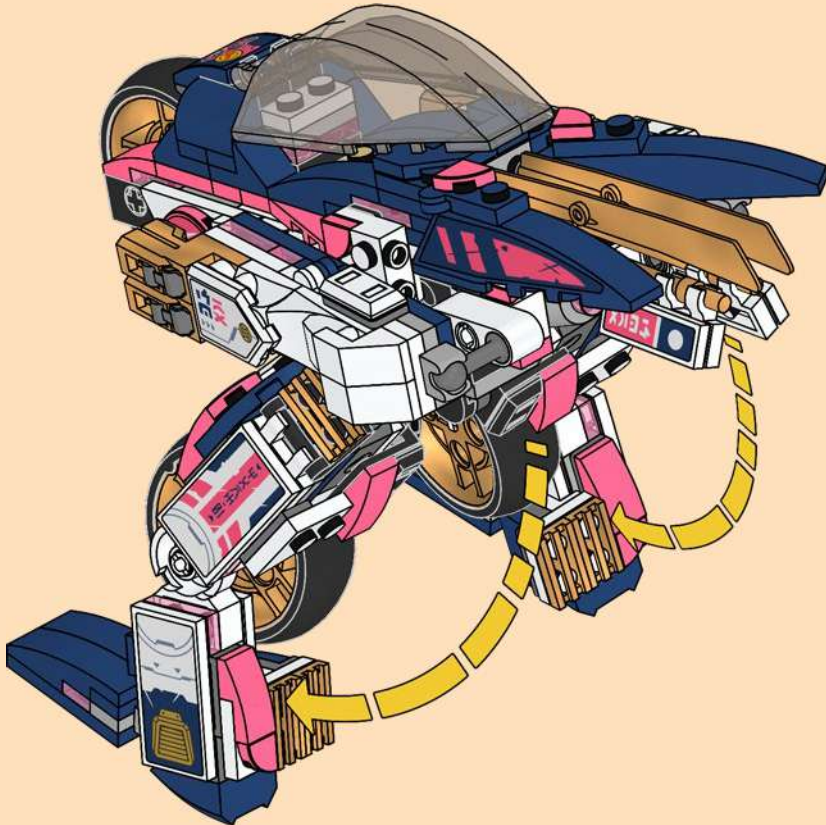

2

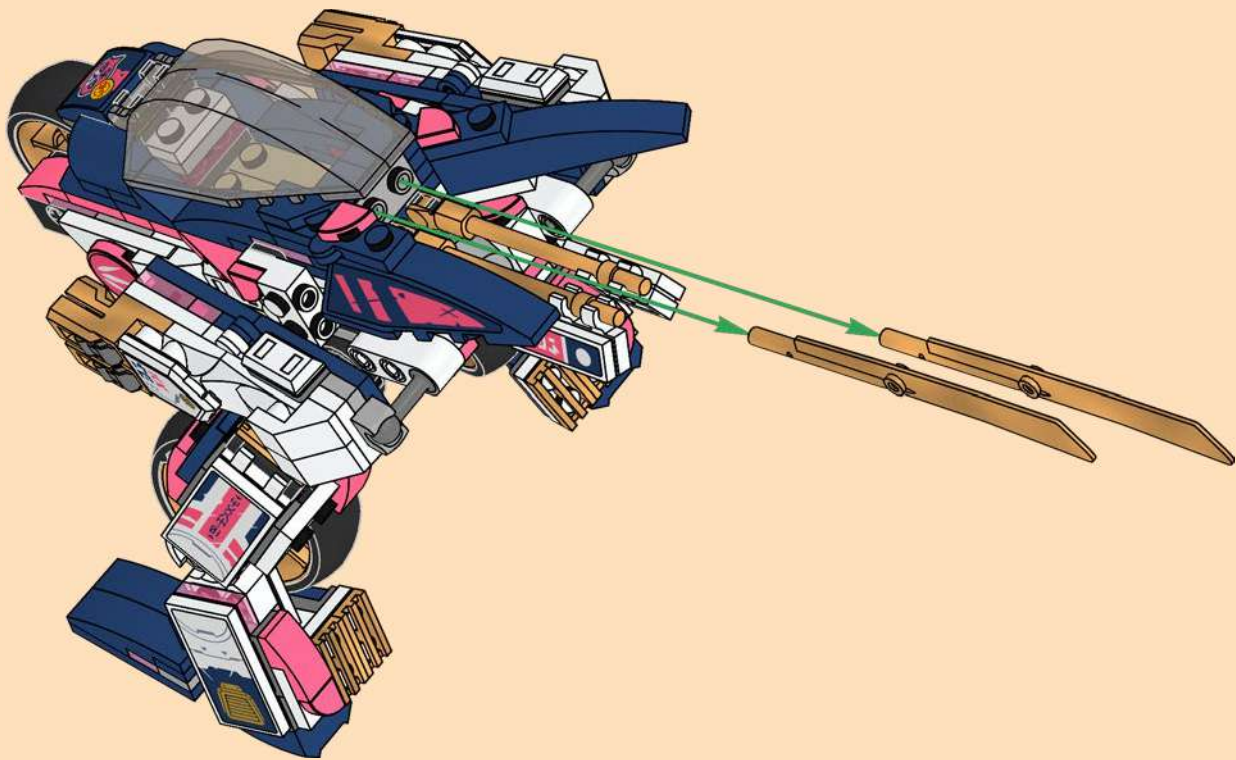

3

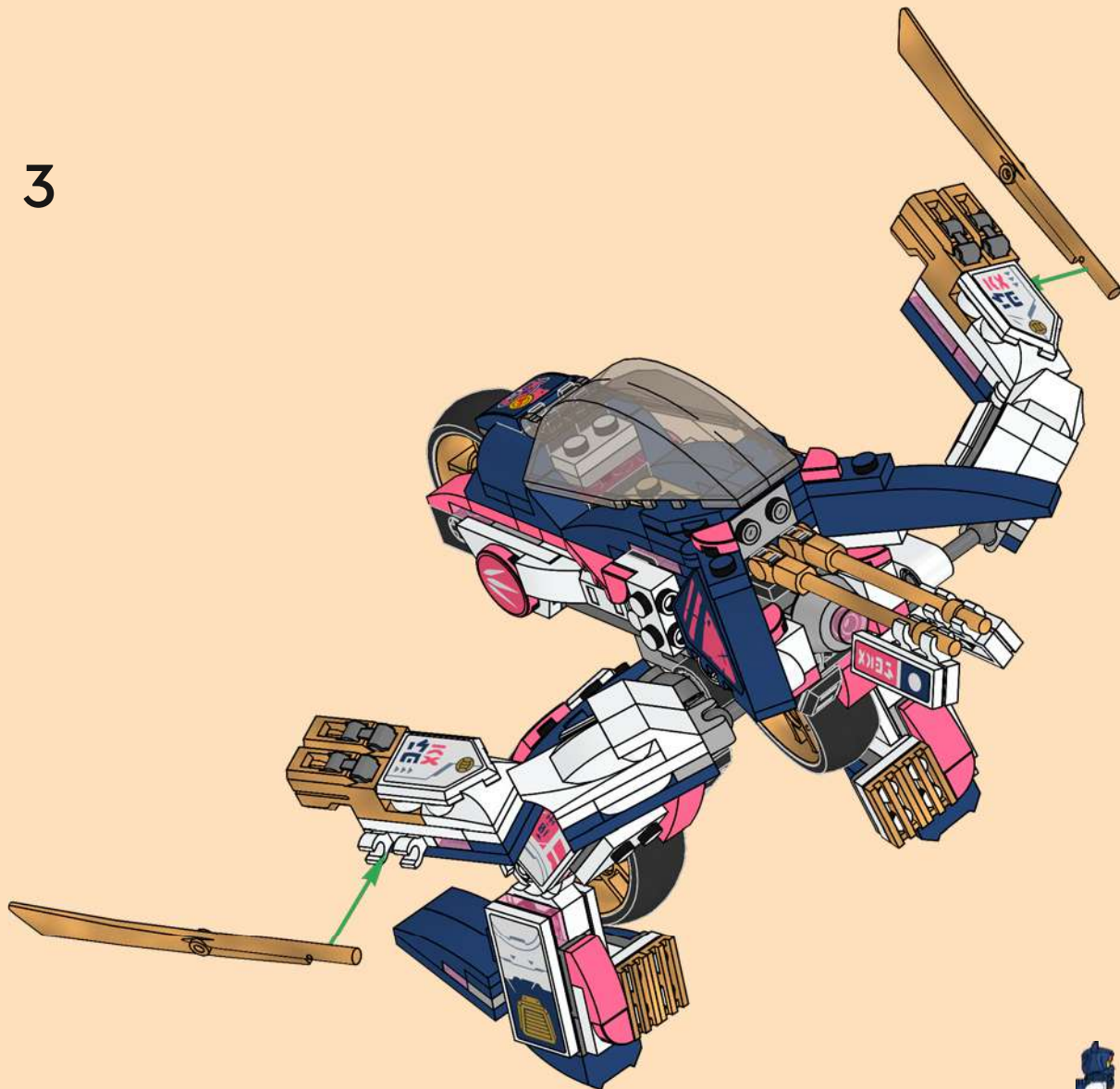

4

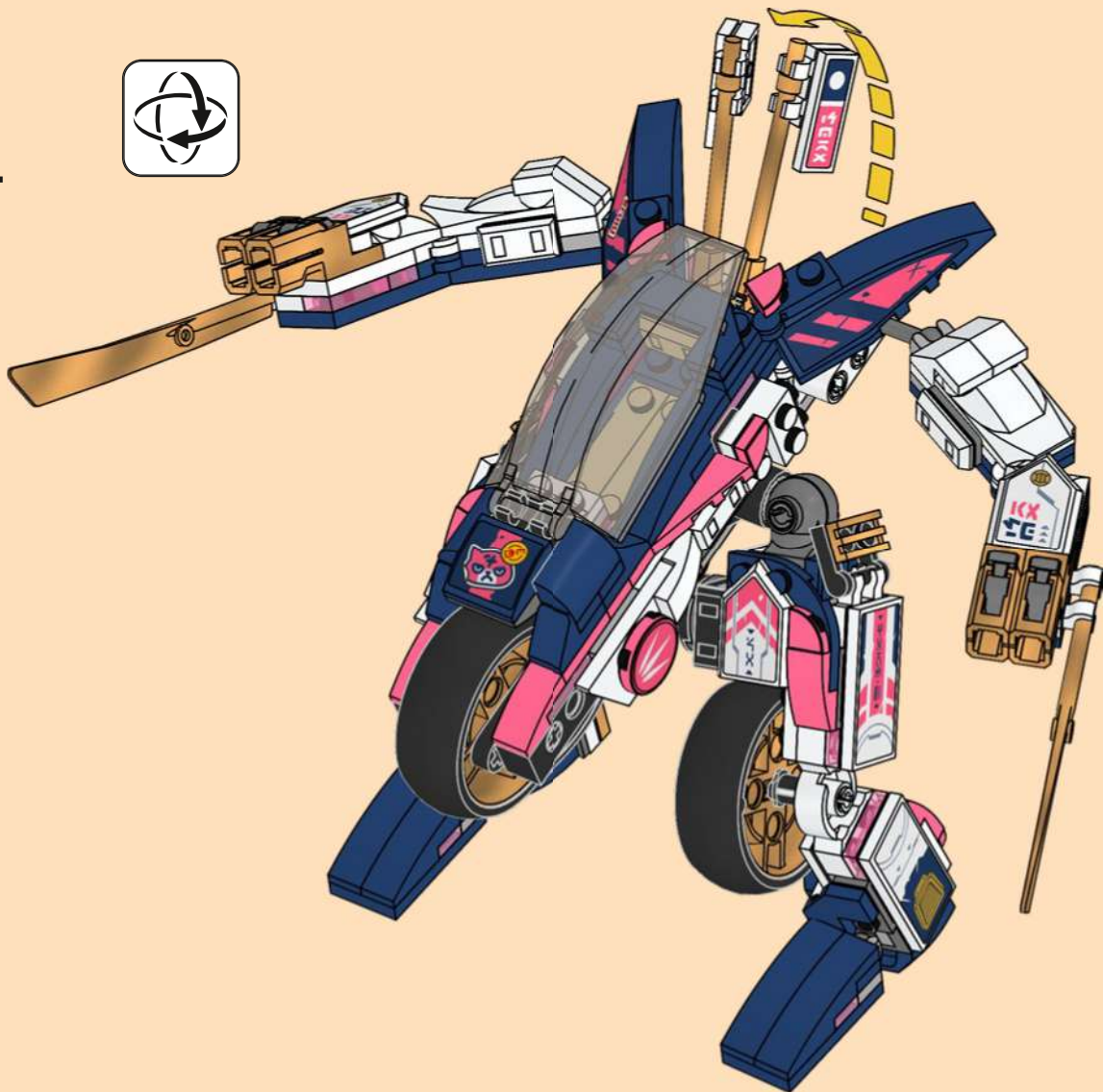

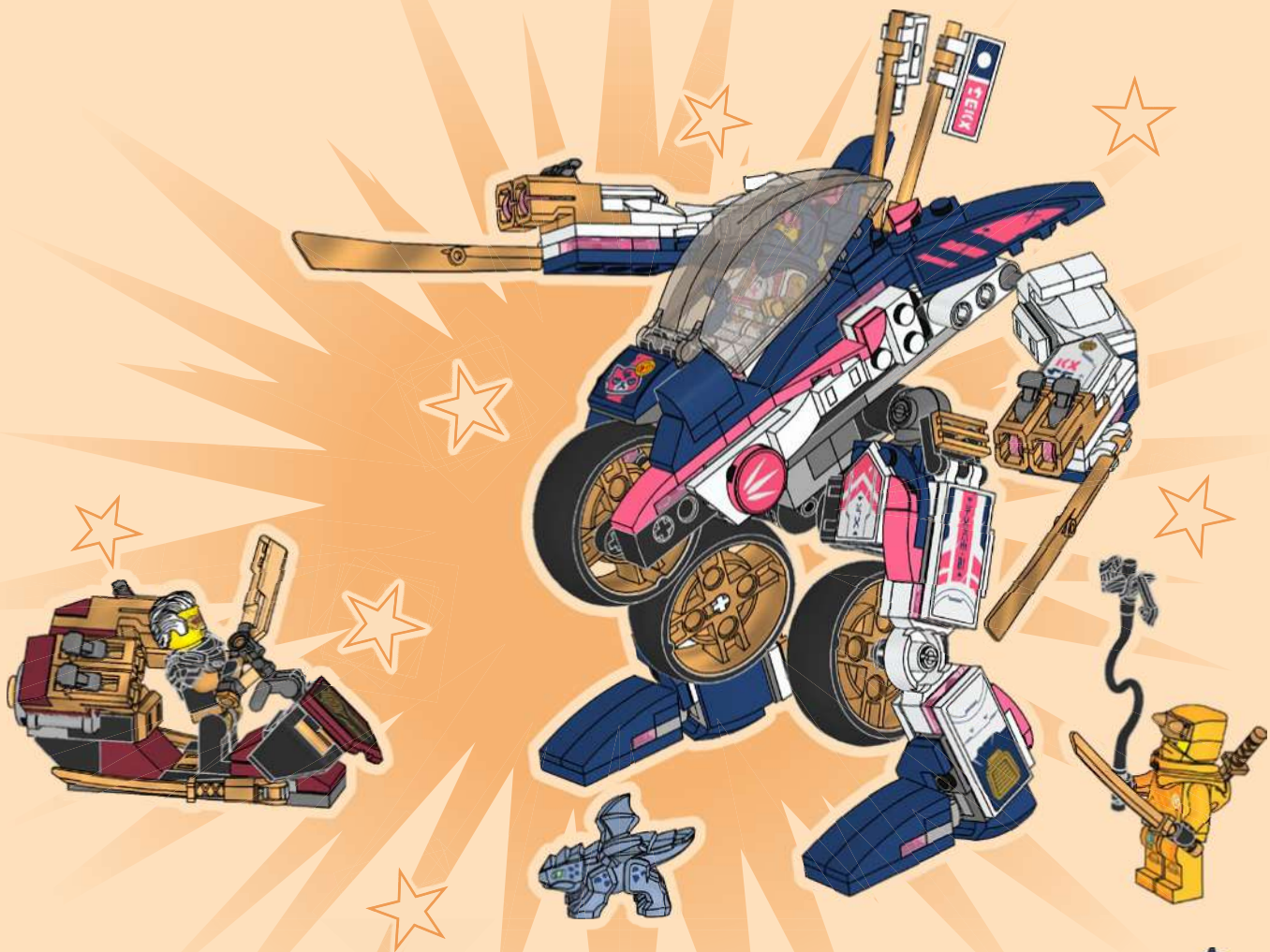

LEGO

NINJAGO

DRAGONS RISING



71795



71791



71797



71789



71790



71798



71777



71778



71779



71799



71796



71792



71793



71794

4x 6296132		1x 6262496		2x 4208160		2x 6332148		1x 6276951		4x 6186683
5x 6210272		1x 6437615		2x 6289797		2x 6234695		1x 6437168		2x 6384915
1x 4179875		1x 6434456		2x 4558168		1x 6070695		1x 6425507		1x 6437172
1x 4179874		1x 6245249		1x 6271228		1x 6195325		1x 6425507		3x 6061569
2x 6046979		2x 4249506		1x 4114306		2x 4109810		5x 6117973		4x 6166854
4x 6210076		7x 302101		2x 6257600		6x 6156991		2x 6363033		2x 6441154
4x 6166894		2x 4610897		1x 6130009		4x 6347310		1x 6170529		2x 6251836
2x 6034044		4x 6416527		1x 6442565		3x 393726		1x 6296186		6x 6042956
4x 6018774		4x 6440438		1x 6434457		1x 6313116		1x 6296186		1x 4502089
6x 6347287		4x 6440438		1x 6434476		2x 4225201		2x 389526		4x 6416530
2x 6311891		2x 6053026		1x 6437582		2x 6331723		4x 4184108		9x 4667595
2x 306801		2x 379501				3x 4124096		1x 6430280		1x 6106176
2x 4494474		2x 6425460				1x 6052126		6x 4528981		1x 6106167
				1x 6430279		1x 370526				

9x
6274745

15x
6240228

9x
6274747

1x
6430281

1x
6240500

1x
6434460

1x
6437173

1x
6437858

2x
6296894

1x
6183782

1x
6028324

1x
4657459

4x
6043656

6x
4654582

2x
4654580

2x
4244627

11x
4211397

1x
4211396

1x
6347992

1x
4560183

1x
4211639

1x
4612621

2x
6170470

4x
6296657

1x
6430278

1x
6434474

6x
4490599

4x
6207933

8x
6345949

1x
6337403

6x
6116596

2x
6270131

3x
6395295

1x
6434535

1x
6322830

4x
6083977

1x
4609925

5x
4585479

1x
6291066

8x
6360675

4x
4211042

1x
4278274

2x
6365695

2x
6178919

16x
6000606

1x
4261908

2x
4522784

2x
6123814

1x
6344820

2x
6309059

2x
6324639

2x
6343337

1x
4243831

1x
4210997

10x
6250022

4x
6258091

1x
6395568

1x
6395569

2x
6258405

8x
6258075

2x
6258094

1x
6258095



[LEGO.com/service](https://www.LEGO.com/service)

YOU COULD **WIN**



Scan this QR code or go to **LEGO.COM/PRODUCTFEEDBACK** and give us your short feedback about this LEGO® set for a chance to win a cool LEGO prize.

Terms and Conditions apply*



EN: YOU COULD WIN. Terms and Conditions apply* **DE: Du könntest GEWINNEN.** Es gelten die Teilnahmebedingungen* **FR: Tu pourrais GAGNER.** Des conditions s'appliquent* **IT: Potresti VINCERE tu.** Termini e condizioni sono applicabili* **ES: Puedes GANAR.** Aplican términos y condiciones* **PT: Poderá GANHAR.** Aplicam-se termos e condições* **ZH: 轻松获奖. 条款和条件适用*** **PL: Szansa na WYGRANĄ.** Obowiązują warunki korzystania* **CS: Máte šanci VYHRÁT.** Platí všeobecné smluvní podmínky* **SK: Máte šancu VYHRAŤ.** Platia všeobecné zmluvné podmienky* **HU: TE IS NYERHETSZ.** Felhasználási feltételek érvényesek* **RO: Ai putea CÂȘTIGA.** Se aplică termeni și condiții* **BG: Можете да СПЕЧЕЛИТЕ.** Има определени правила и условия* **LV: Tu vari LAIMĒT.** Ir spēkā noteikumi un nosacījumi.* **ET: Sul on võimalus VÕITA.** Kehtivad tingimused* **LT: Jūs galite LAIMĖTI.** Taikomos sąlygos*

*[LEGO.com/productfeedback-terms](https://www.lego.com/productfeedback-terms)