



CREATOR™



31088



3 in 1
3 en 1
3 em 1
3 az 1-ben
Trīs vienā
3 合 1

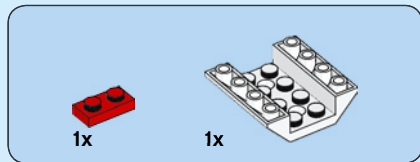
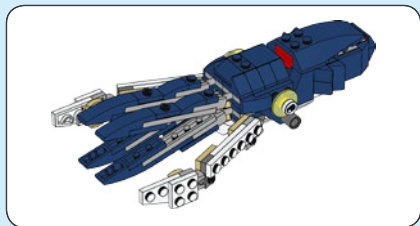

1

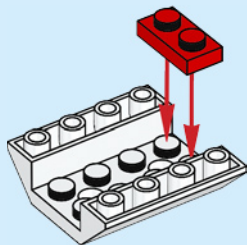



1x

2

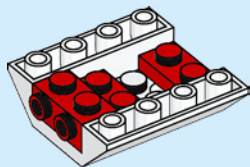

1x

3

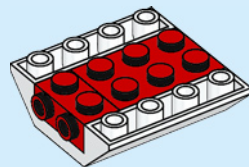

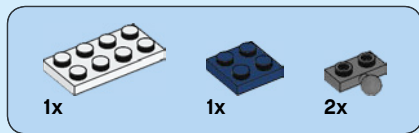

4

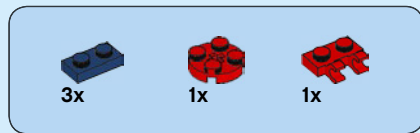
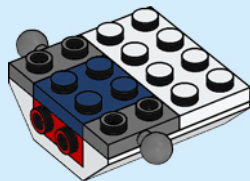

5

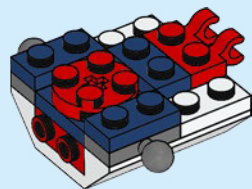



6

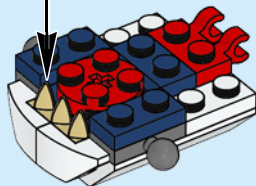
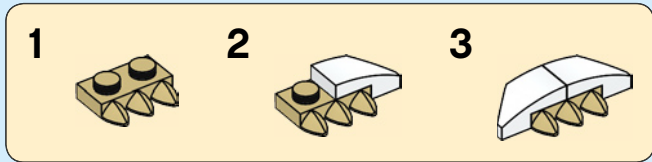



1x



2x

7

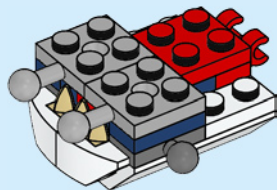

6



1x



2x



1x

8

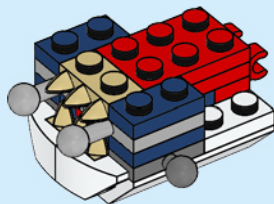



1x

9

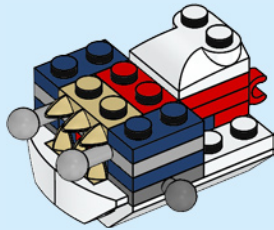

2x

10

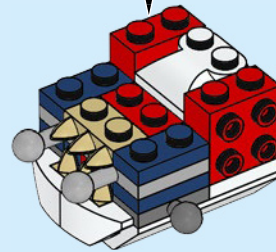
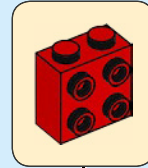



2x

11

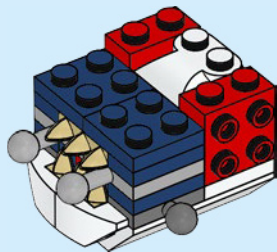

2x

12

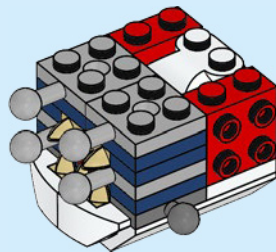



2x

13

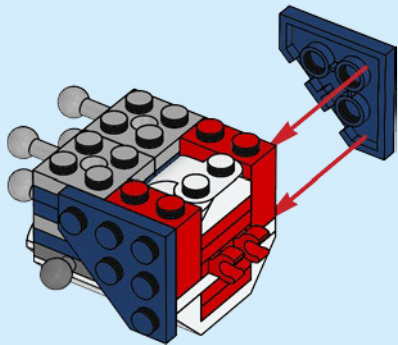

2x

14

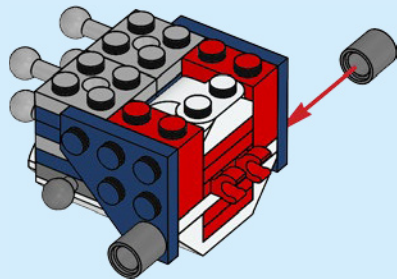



15

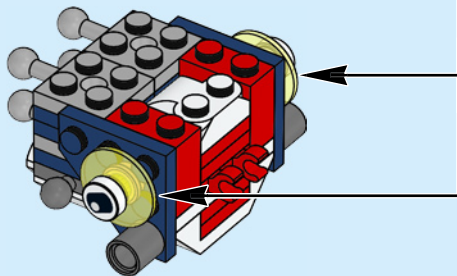



16

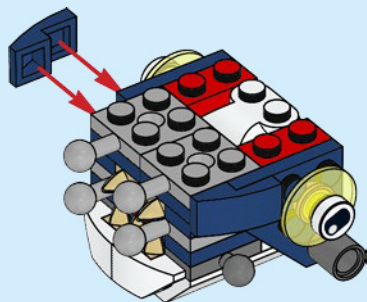

17

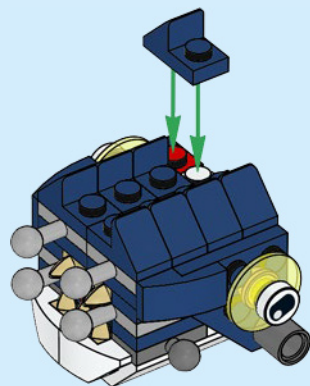



1x



1x

18

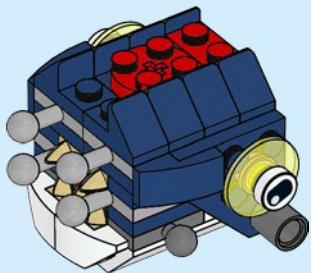

1x



1x



1x

19

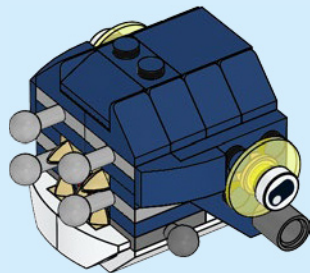

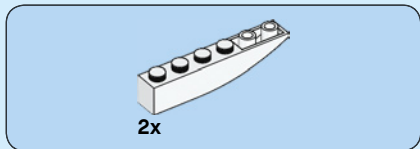

20

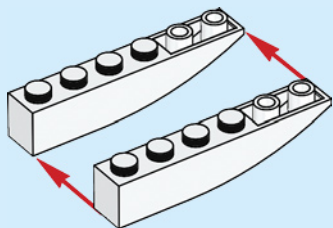

21

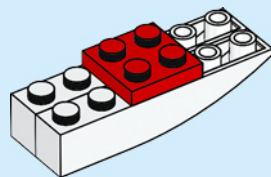



2x

22

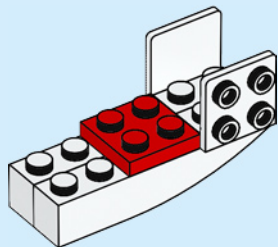

2x

23

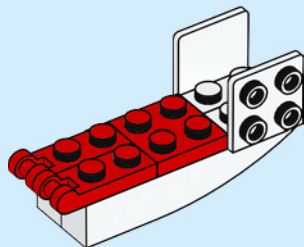

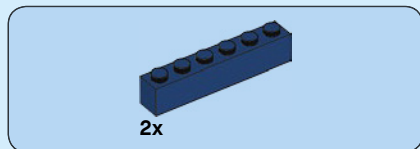

24

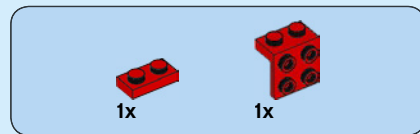
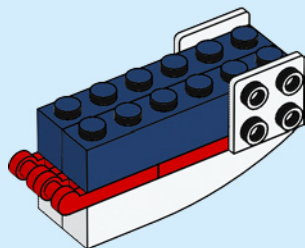

25

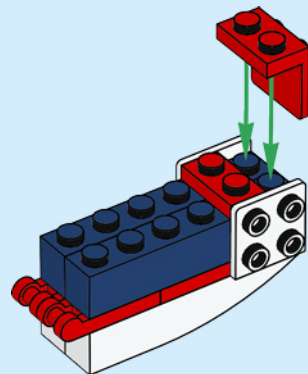



2x

26

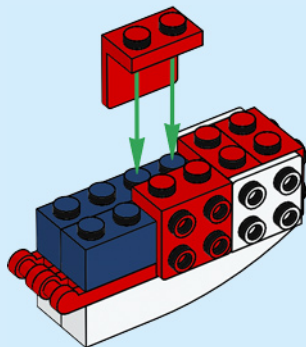



27

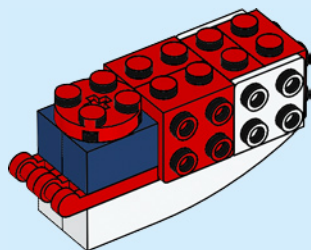

28

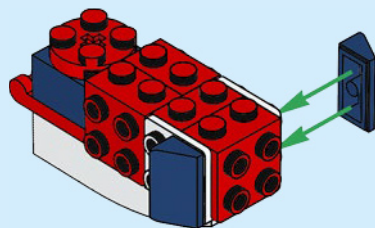

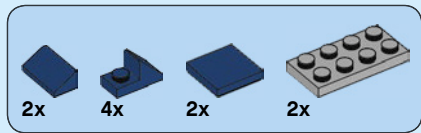

29

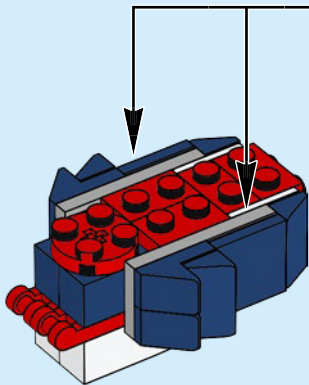
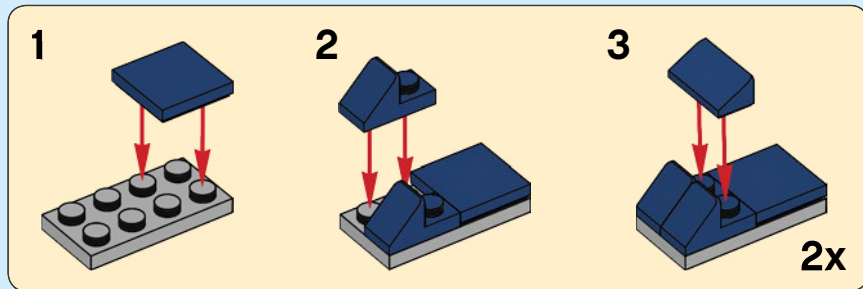

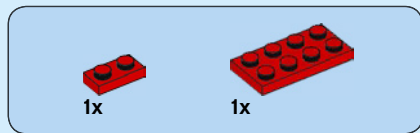

30

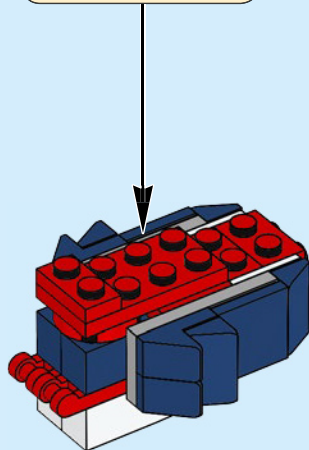
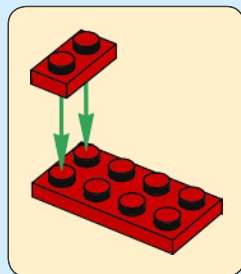

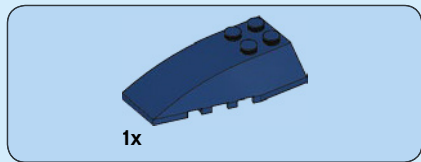

31

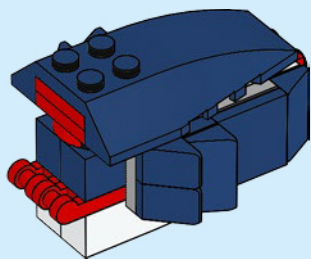

32

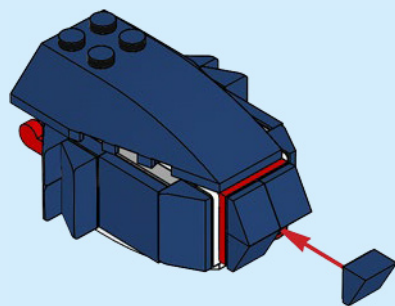

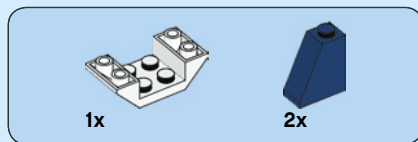

33

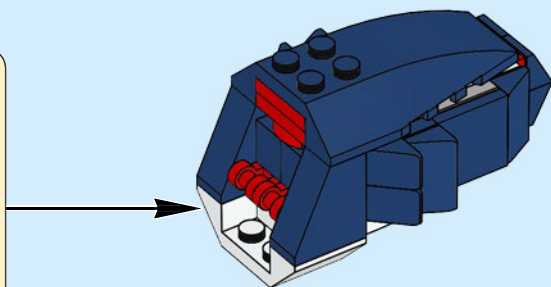
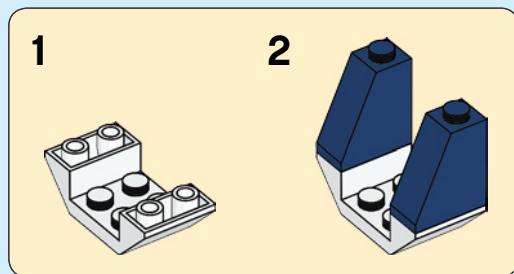

34

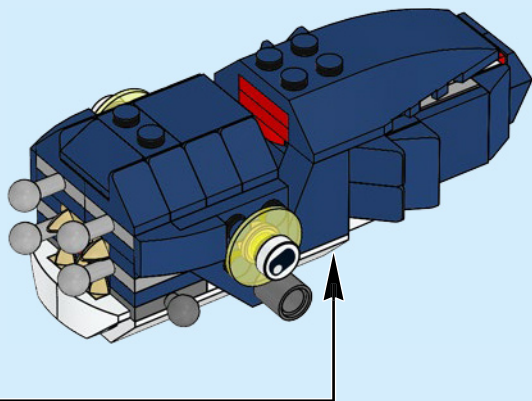

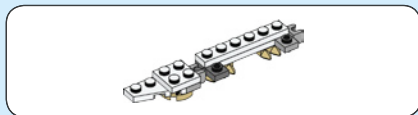

35

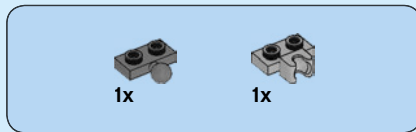
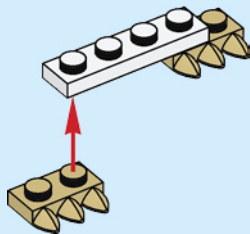

36

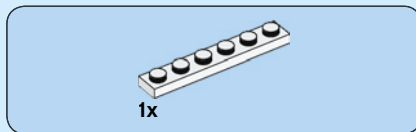
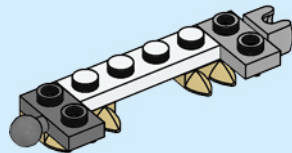

37

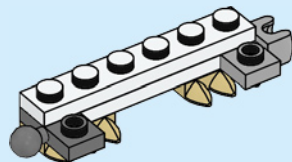



38

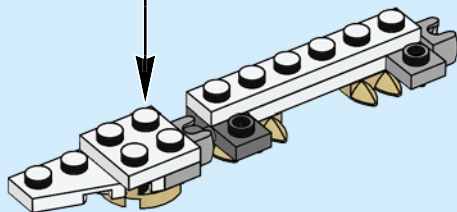
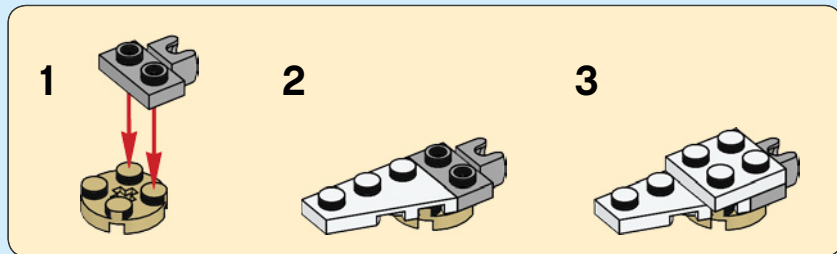

39

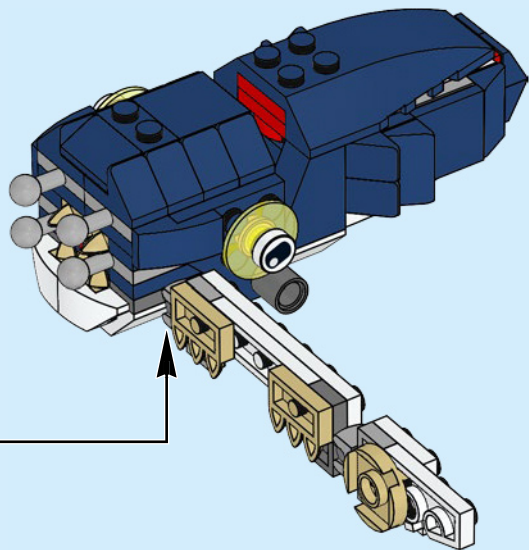

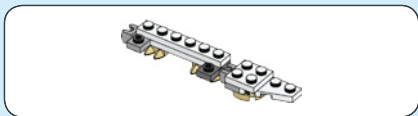

40

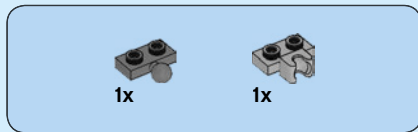
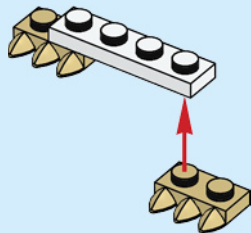

41

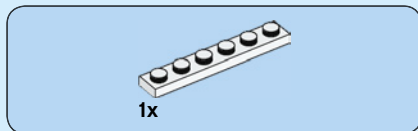
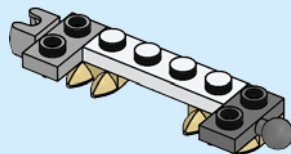

42

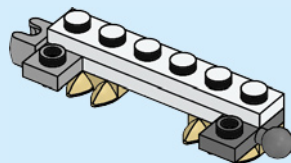

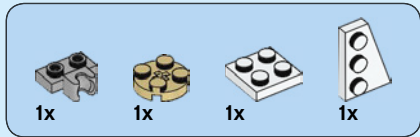

43

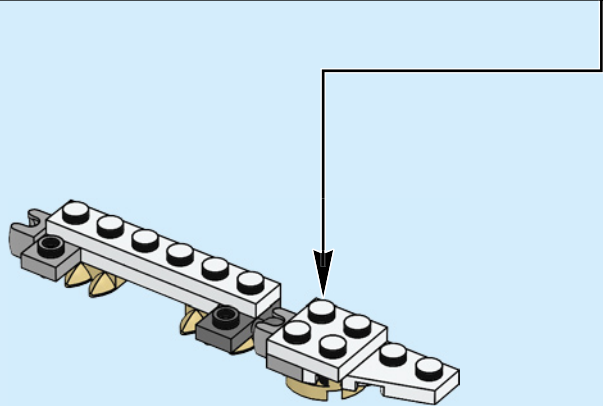
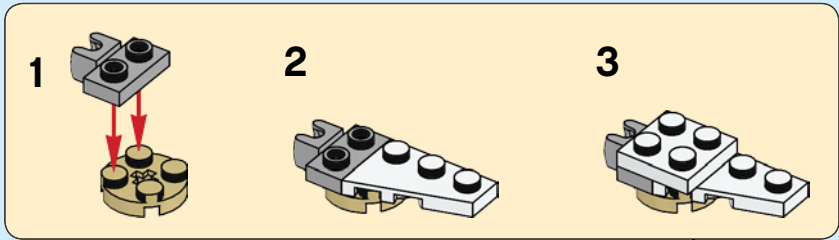

44

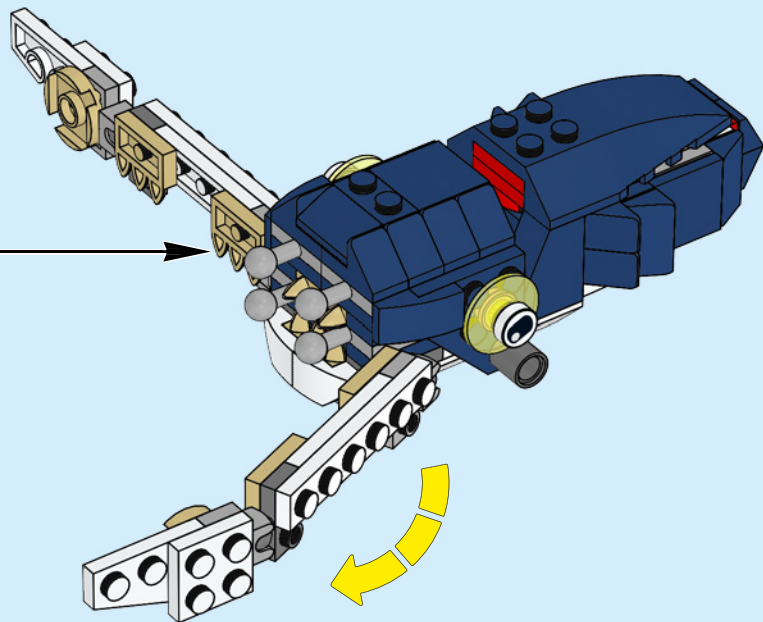



2x



1x



1x

45

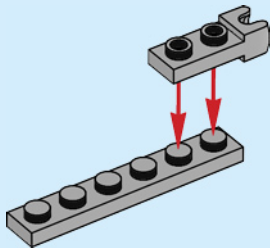

1x

46

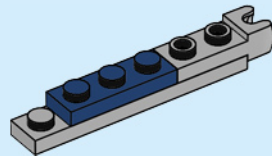



1x



1x

47

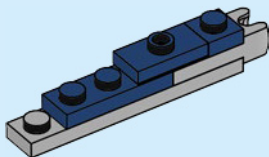



1x

48

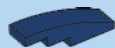
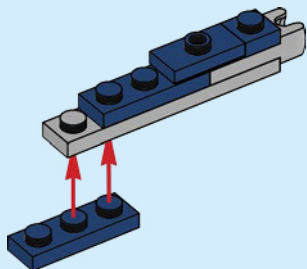

1x

49

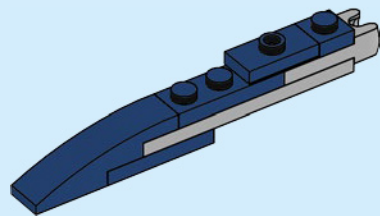

2x

50

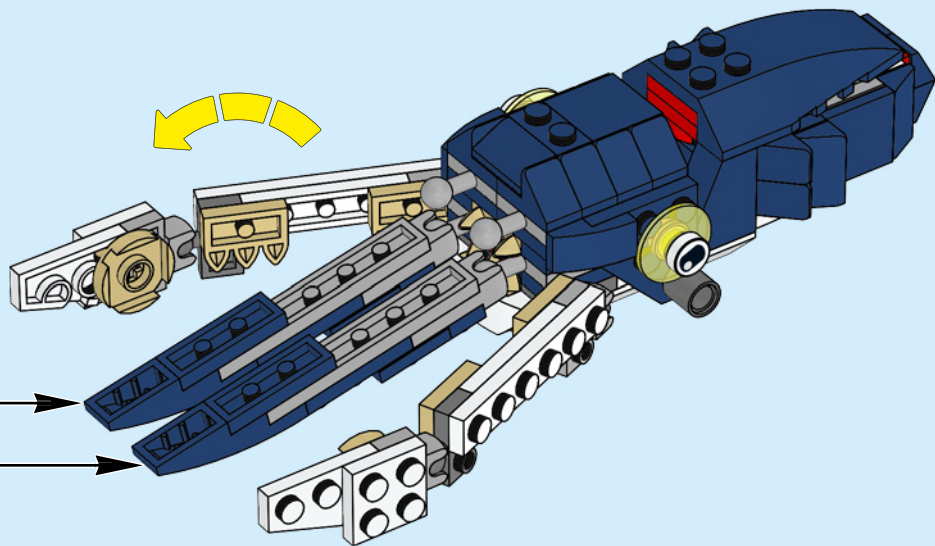



2x

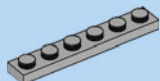

1x



1x

51

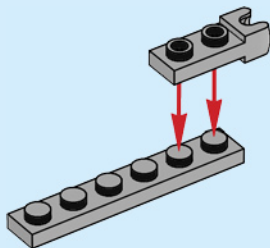

1x



1x



1x

52

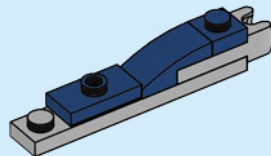



1x

53

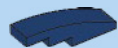
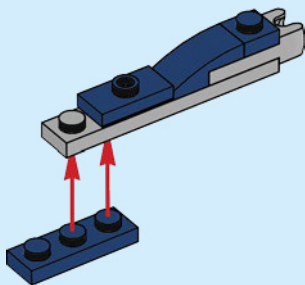

1x

54

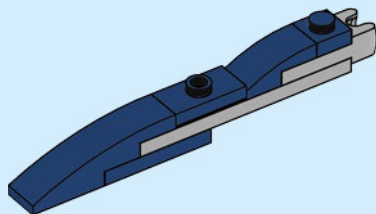

2x

55

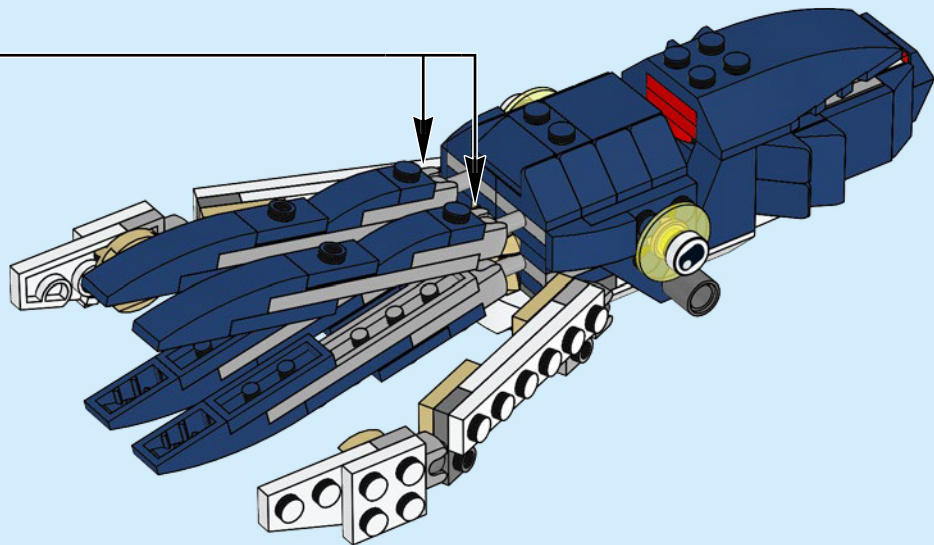



CREATOR™

LEGO and the LEGO logo are trademarks of the/son des marques de commerce du/son marcas registradas de LEGO Group.

©2019 The LEGO Group. 6263537/6263590

4 →

