

TS 1500



101827-10

**GEZE**



10 mm

**A**

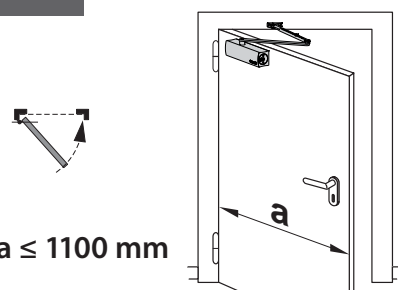

$a \leq 1100 \text{ mm}$

**B**

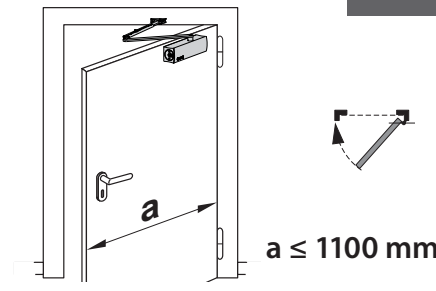

$a \leq 1100 \text{ mm}$

EN 3/4

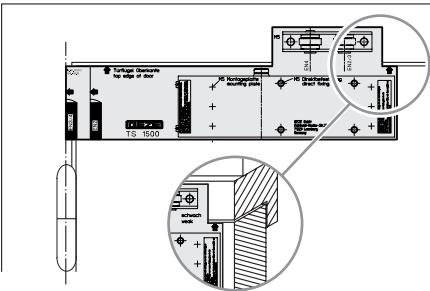

EN 3/4

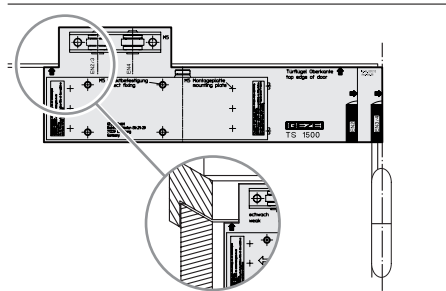

EN 2

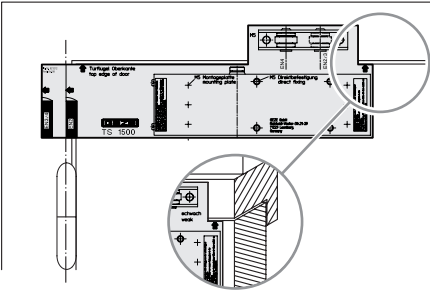

EN 2

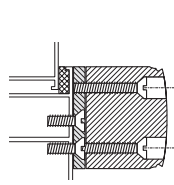
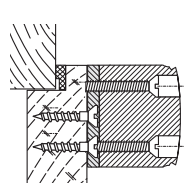
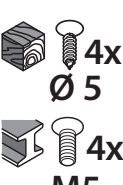
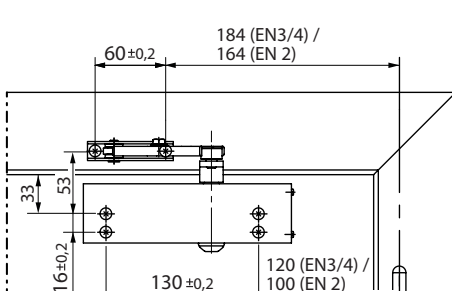
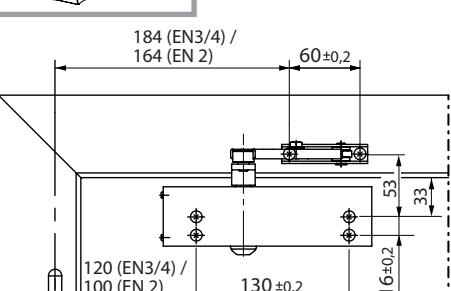
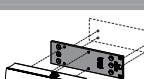
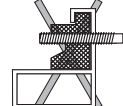
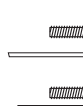
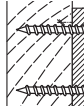
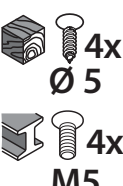
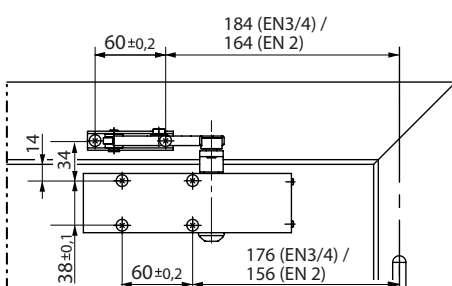
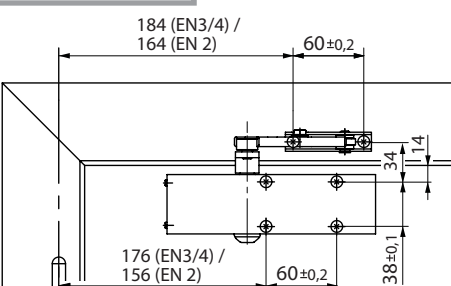
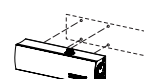
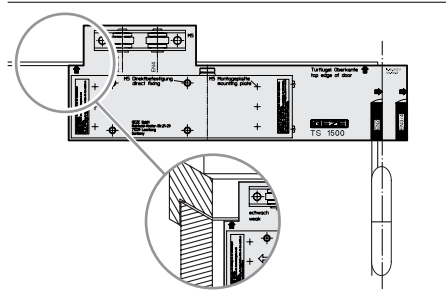

4x  
M5x34

**1**

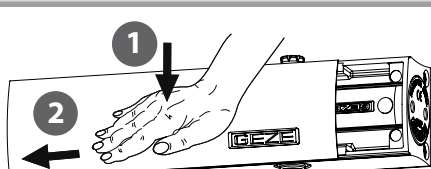

**2**

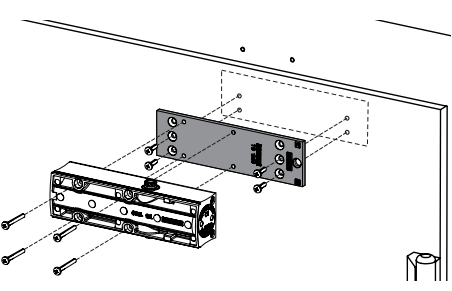
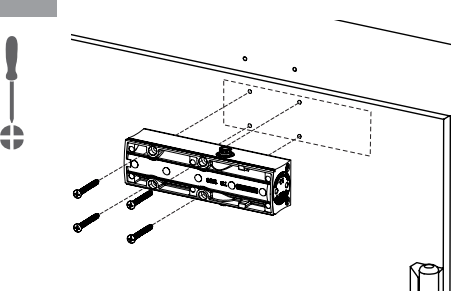

**3**

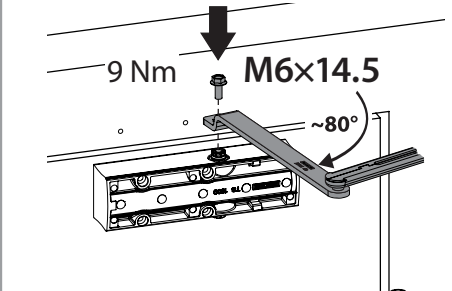
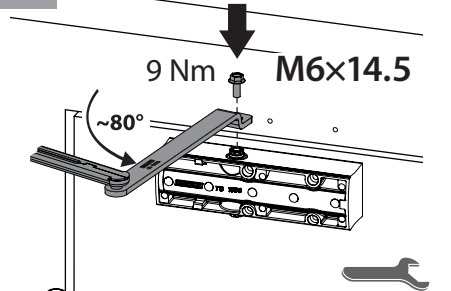

4

a = 950 - 1100 mm (EN 4)

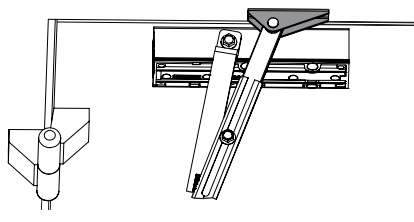

a < 950 mm (EN 3)

a < 850 mm (EN 2)

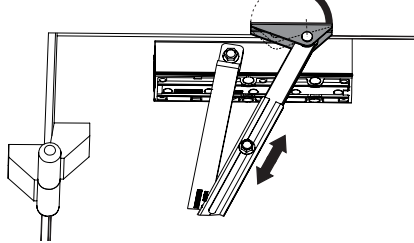

a = 950 - 1100 mm (EN 4)

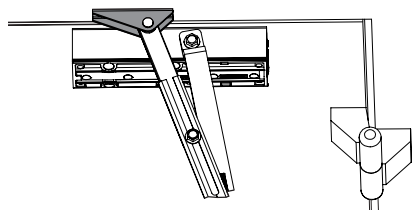

a < 950 mm (EN 3)

a < 850 mm (EN 2)

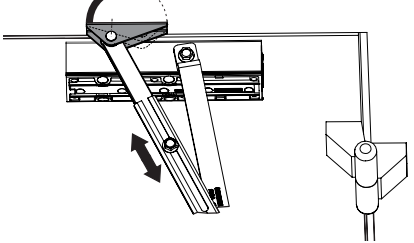

5

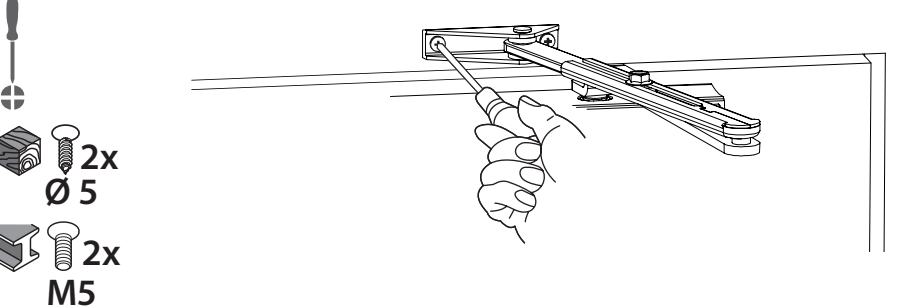

6

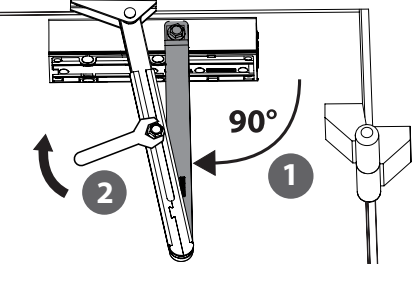
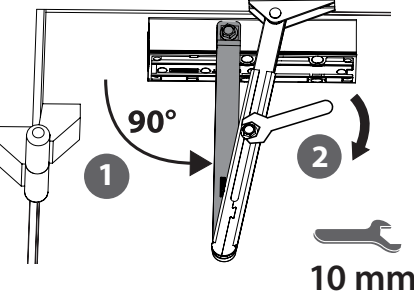

7

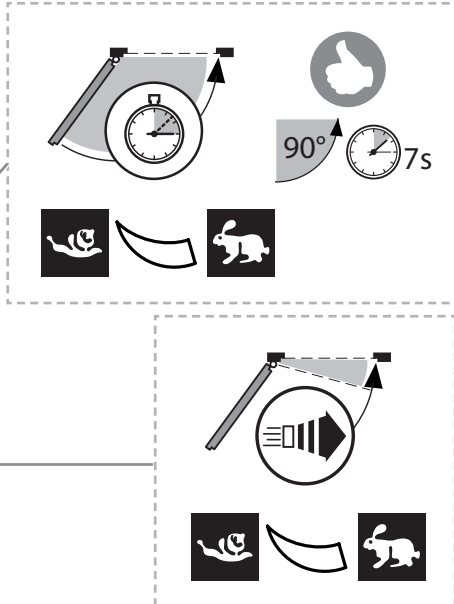
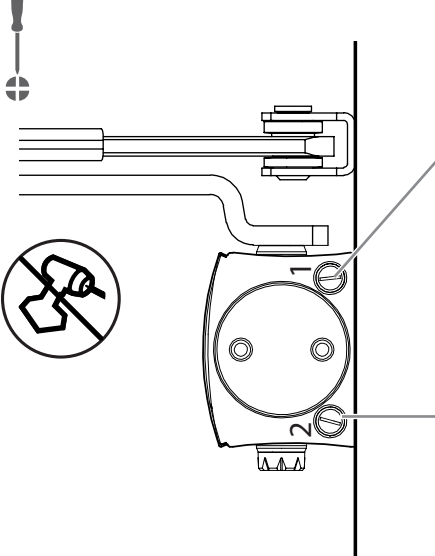

8

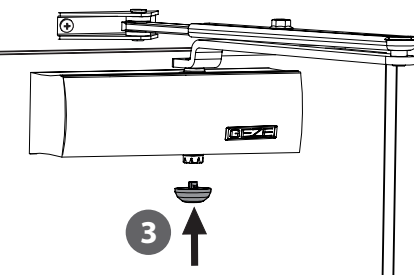
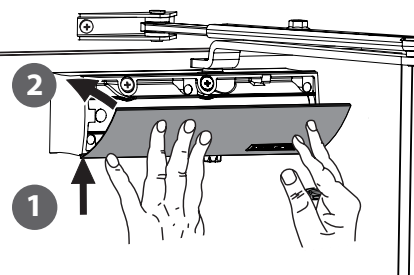

i

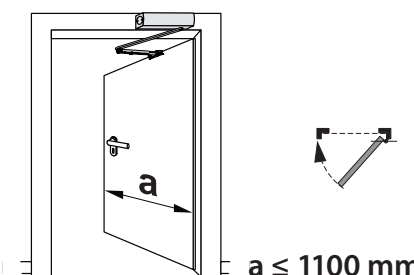

EN 3/4

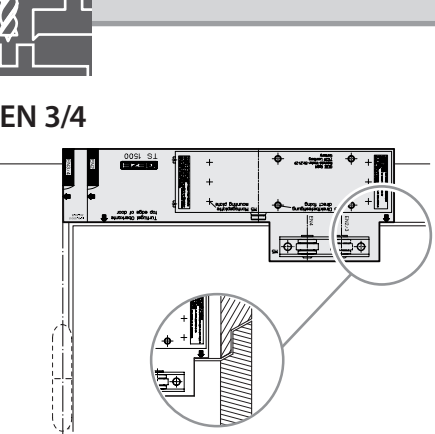

EN 3/4

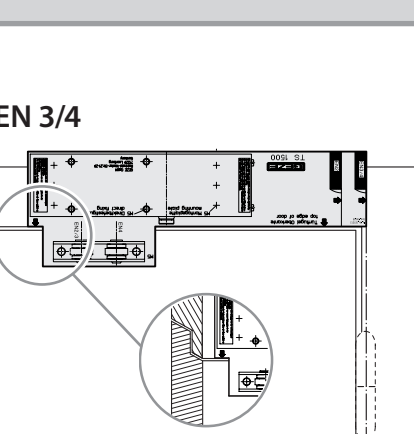

EN 2

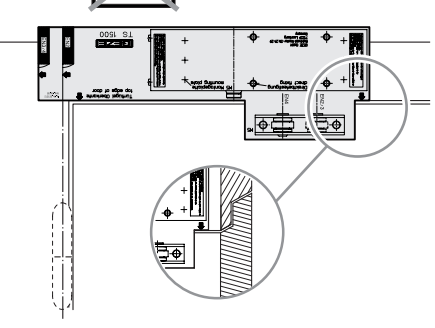

EN 2

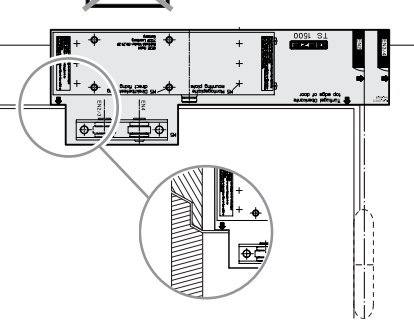

EN 3/4

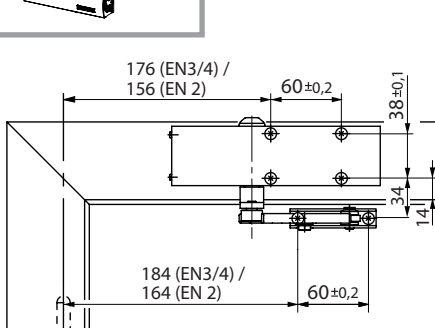

EN 3/4

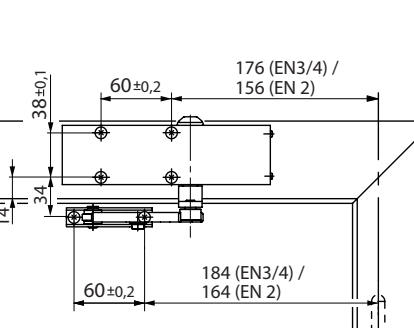

EN 2

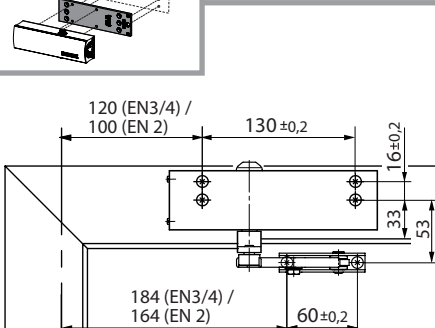

EN 2

