

BRAUN

MultiQuick 1



Type HB101A1

Register your product
www.braunhousehold.com/register

Hand blender

English

8

عربي

10

© Copyright 2022 All rights reserved
De'Longhi Braun Household GmbH
Carl-Ulrich-Straße 4
63263 Neu-Isenburg/Germany

5722170031/03.22

MQ 10.000P-10.001P-10.001M-10.201M-10.202M
UK/AR



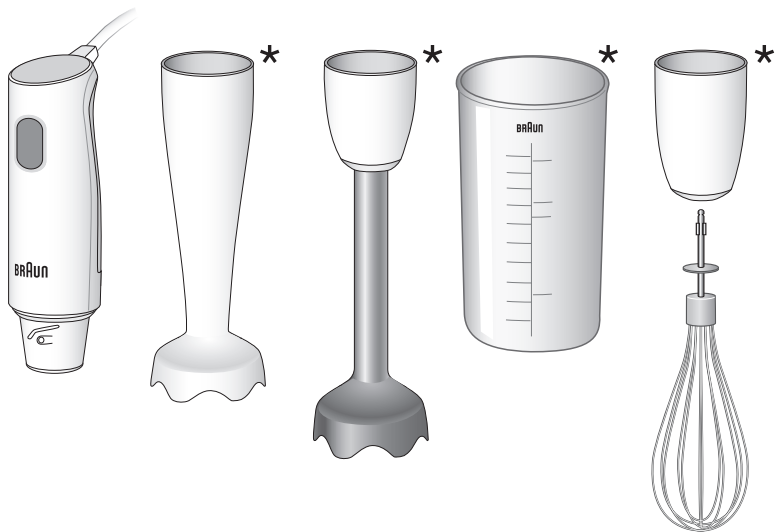

220-240 V~ 50-60 Hz 450-600 W

* certain models only

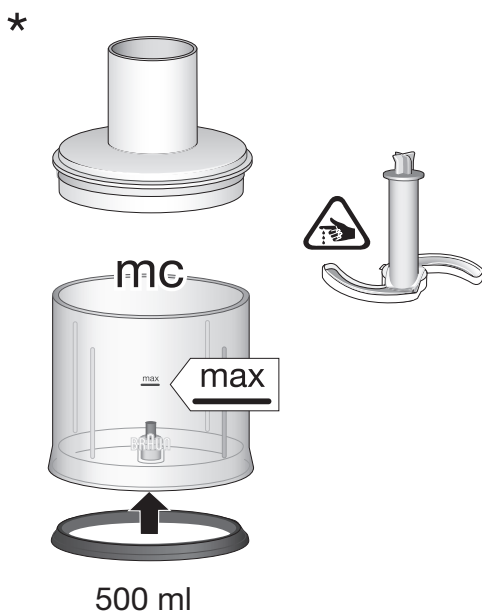
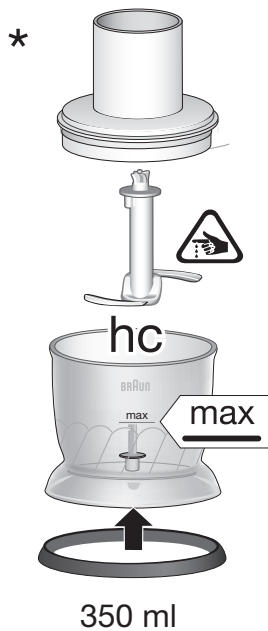

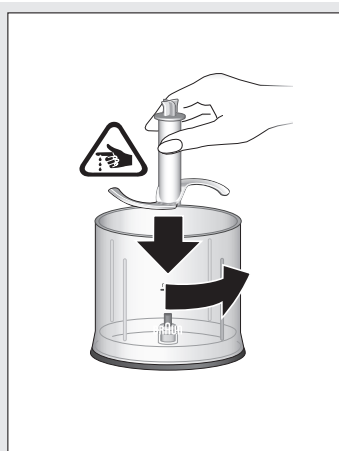
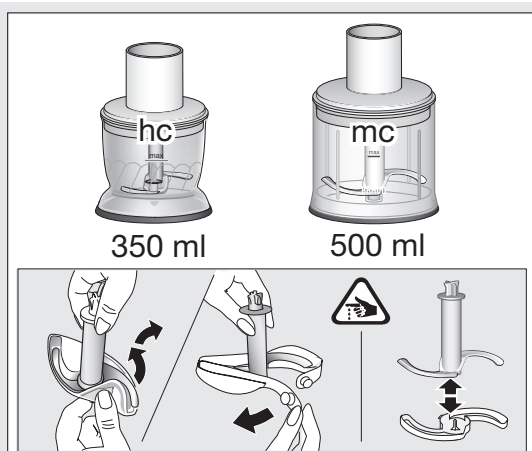
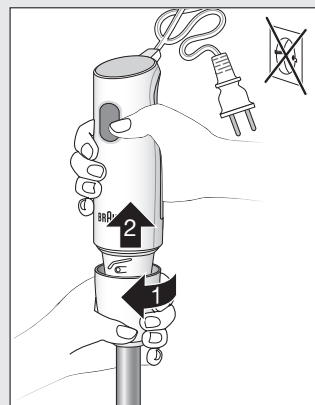
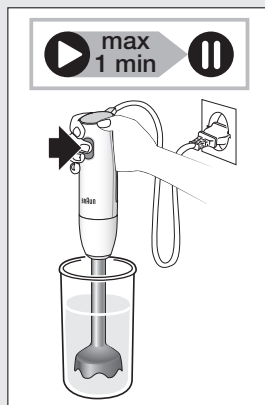
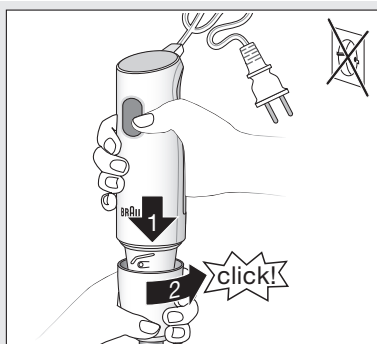
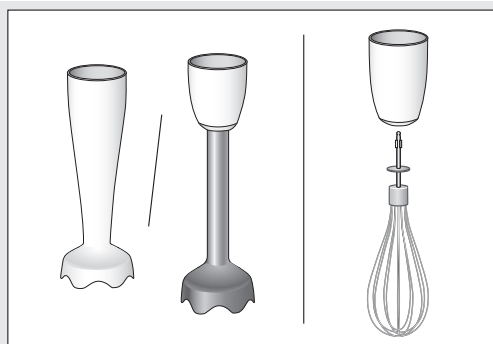

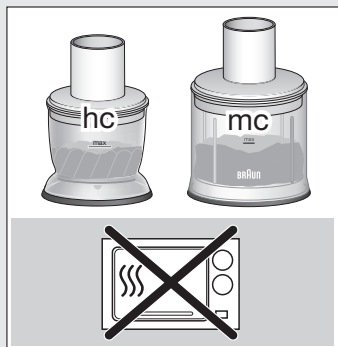
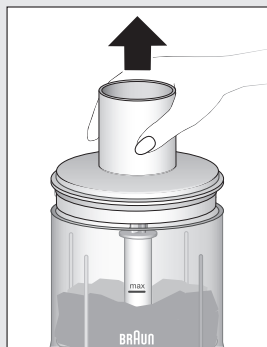
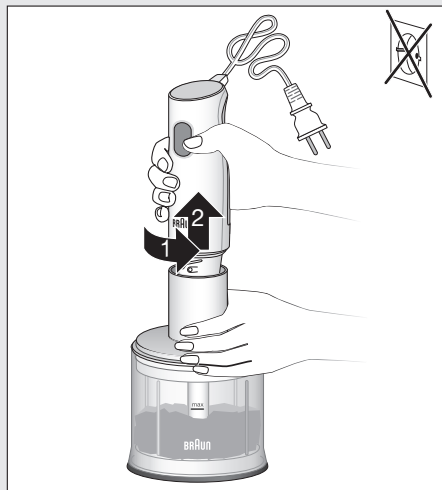
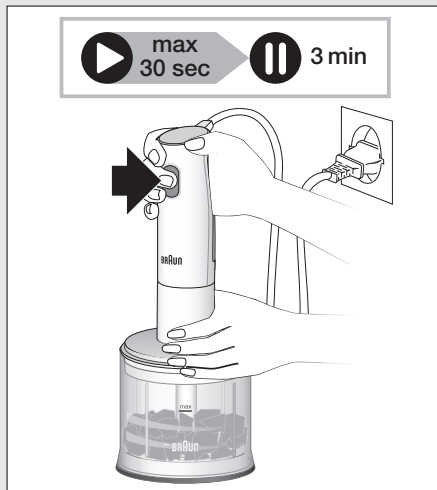
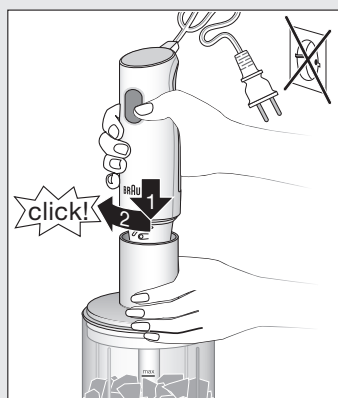
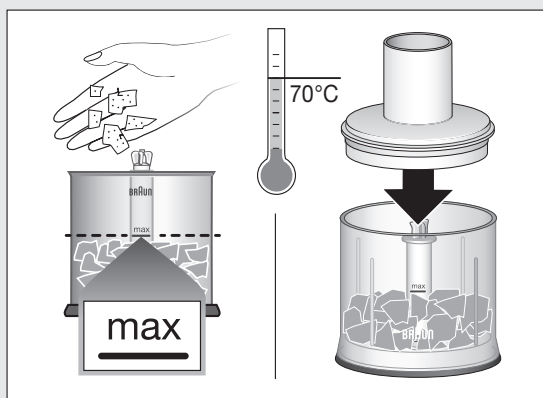



350 ml

		Parmesan 							
	 2 cm	 2 cm					 2 cm		
max.		100 g	90g+ 	10 g	50 g	7	80 g	80 g	100 g
sec.		15	30	5x1	5x1	5x1	5	10x1	10



500 ml

		Parmesan 						
	 2 cm	 2 cm				 2 cm		
max.	300 g	200 g	30 g	200 g	20	200 g	250 g	350 g
sec.	20-30	20-25	10x1	10x1	10x1	5	10	25

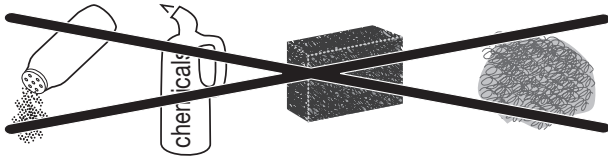
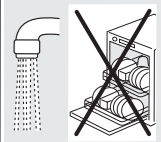
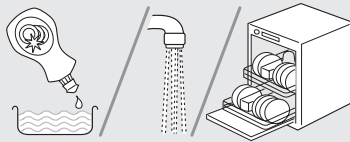
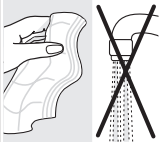

English

Before Use



Please read the user instructions carefully and completely before using the appliance and retain for future reference. Remove all packaging and labels and dispose them appropriately.

Caution

-  The blades are very sharp! To avoid injuries, please handle blades with utmost care.
- Care shall be taken when handling the sharp cutting blades, emptying the bowl and during cleaning.
- This appliance can be used by persons with reduced physical, sensory or mental capabilities or lack of experience and knowledge if they have been given supervision or instruction concerning use of the appliance in a safe way and if they understand the hazards involved.
- Children shall not play with the appliance.
- This appliance shall not be used by children.
- Children shall be kept away from the appliance and its mains cord.

- Always unplug and switch off the appliance when it is left unattended and before assembling, disassembling, cleaning and storing.
- If the supply cord is damaged, it must be replaced by the manufacturer, its service agent or similarly qualified persons in order to avoid a hazard.
- Before plugging into a socket, check whether your voltage corresponds with the voltage printed on the bottom of the appliance.
- This appliance is designed for house-hold use only and for processing normal household quantities.
- Do not use any part in the microwave.
- Please clean all parts before first use or as required, following the instructions in the Care and Cleaning section.
- Stop using the device if it is damaged.
- If the device falls into liquid, unplug, before reaching into the liquid.

EN

Use only for mixing (soups, dips, sauces, baby food, drinks, smoothies, milkshakes), whipping (cream, beating egg whites) and chopping (hard cheese, onions, herbs, garlic, vegetables, bread, cracker, nuts).

«hc» Recipe example: Honey-Prunes (as a pancake stuffing or spread)

40 g prunes

40 g creamy honey

10 ml water (vanilla-flavour)

- Fill the «hc» chopper bowl with prunes and creamy honey.
- Chop 4 seconds at maximum speed
- Add 10 ml water (vanilla-flavoured).
- Chop 1 second at maximum speed

For UK Only

Guarantee Information

All Braun Household products carry a minimum guarantee period of two years. The rights and benefits under this guarantee are additional to your statutory rights which are not affected. **Please keep your receipt as this will form the basis of your guarantee.**

In the unlikely event of a breakdown you have access to professional help from our team simply by calling:
02392 392333

For service in the Republic of Ireland please call: 0345 222 0458

Braun Household undertakes within the specified period to repair or replace any part of the appliance, free of charge (with the exception of any glass or porcelain-ware incorporated in the product) found to be defective provided that;

- We are promptly informed of the defect.
- The product is used and maintained in accordance with the User Instructions.
- The appliance has not been altered in any way or subjected to misuse or repair by a person other than an authorised service agent for Braun Household.
- No rights are given under this guarantee to a person acquiring the appliance second hand or for commercial or communal use.
- Any repaired or replaced appliance will be guaranteed on these terms for the unexpired portion of the guarantee.
- The need for repair has not been caused by insufficient aftercare or cleaning: or damage caused by the chemical or electrochemical effects of water.

Under no circumstances shall the application of this guarantee give rise to the complete replacement of the appliance or entitle the consumer to damages.

Braun Household, New Lane, Havant, Hampshire PO9 2NH
www.braunhousehold.co.uk

Thank You for choosing Braun. We are confident that you will get excellent service from this product.

TO IMPROVE YOUR EXPERIENCE

Register now at
www.braunhousehold.co.uk

By registering we may send you from time to time details on exclusive offers, promotions, recipes and inside tips.

عربي

قبل الاستخدام



رُجى قراءة تعليمات الاستخدام بعناية وبشكل تام قبل استخدام الجهاز والاحتفاظ بها للرجوع إليها في المستقبل. أزل جميع مواد التغليف والملصقات وتخلص منها بشكل مناسب.

تنبيه



- الشفرات حادة للغاية. لتجنب الإصابات، يُرجى التعامل مع الشفرات بحرص شديد.
- يجب توخي الحذر عند التعامل مع شفرات القطع الحادة، وتفريغ الوعاء أثناء التنظيف.
- يمكن استخدام هذا الجهاز بواسطة الأشخاص ذوي الإعاقات الجسدية، أو القدرات النفسية أو العقلية المحدودة، أو ممن لديهم تجربة قليلة ومعرفة محدودة، وذلك إذا تم إرشادهم أو تدريبهم على استخدام الجهاز بطريقة آمنة، وإذا كانوا على دراية بالمخاطر التي ينطوي عليها استخدام الجهاز.
- جب ألا يعبت الأطفال بالجهاز.
- جب ألا يستخدم الأطفال هذا الجهاز.
- يجب إبقاء الأطفال بعيداً عن الجهاز وعن كابل التيار الكهربائي الرئيسي الخاص به.
- قم دائماً بفصل التيار الكهربائي عن الجهاز أو إغلاقه، عندما تتركه بعد العمل عليه، وكذلك قبل التركيب أو التفكيك أو التنظيف أو التخزين.
- إذا كان كابل التيار الكهربائي تالفاً، فإنه يجب استبداله بواسطة جهة الصّنع، أو وكيل الخدمة التابع لها، أو بواسطة شخص يتمتع بخبرات فنية مماثلة، وذلك بغرض تفادي أية مخاطر.
- قبل توصيل الجهاز بمقبس التيار، يجب التحقق من أن الجهد الكهربائي للتيار لديك يتوافق مع قيمة الجهد الكهربائي المطبوع أسفل الجهاز.
- تم تصميم هذا الجهاز للاستخدام المنزلي فقط ولأغراض معالجة الكميات المنزلية الطبيعية.
- لا تستخدم أي جزء من هذا الجهاز داخل الميكروويف.
- يُرجى تنظيف كل الأجزاء قبل أول استخدام أو على النحو المطلوب، مع اتباع الإرشادات الموجودة في قسم الرعاية والتنظيف.

استخدم فقط للخلط (الحساء، صلصة الغمس، الصلصات، طعام الأطفال، المشروبات، العصائر، اللبن المخفوق) وللخفق (الكريمة، بياض البيض المخفوق) وللتقطيع (الجبن الصلب، البصل، الأعشاب، الثوم، الخضراوات، الخبز، رقائق البسكويت، والمكسرات).

«hc» مثال لوصفة: عسل الأراسية (مثل فطائر محلاة مضغوطة أو مفروقة)

40 جرام أراسية

40 جرام العسل الكريبي

10 ملي ماء (بنكهة الفانيليا)

- ملاً وعاء المفرمة «hc» بالأراسية والعسل الكريبي.
- قم بالخلط لمدة 4 ثواني بأقصى سرعة.
- أضف 10 ملي ماء (بنكهة الفانيليا).
- قم بالخلط لمدة 1 ثانية بأقصى سرعة.

