

Размеры корпуса  
Cabinet Dimensions

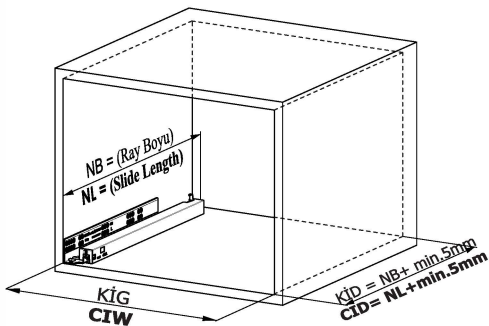

Внутренняя ширина корпуса  
 Внутренняя глубина корпуса  
 Глубина ящика  
 Внутренняя ширина ящика  
 Номинальная длина

Cabinet Internal Width : CIW  
 Cabinet Internal Depth : CID  
 Drawer Depth : DD  
 Drawer Internal Width : DIW  
 Nominal Length : NL

Рекомендованные инструменты  
Recommended Screw and Templates

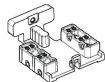

Кондуктор Smart Lock  
Smart Lock Template

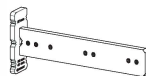

Кондуктор Smart  
для сверления  
Smart Drilling Jig



Кондуктор сверления с  
линейкой  
Smart Drilling Jig with Ruler

Размеры под установку  
Screw Location for the Slides

Закфиксируйте по покрашенным отверстиям

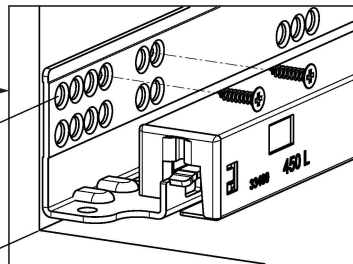
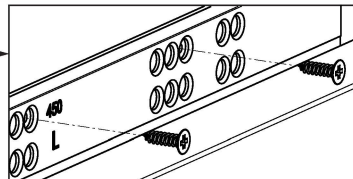
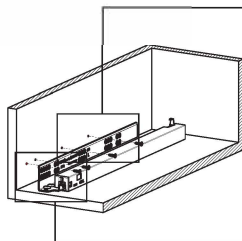
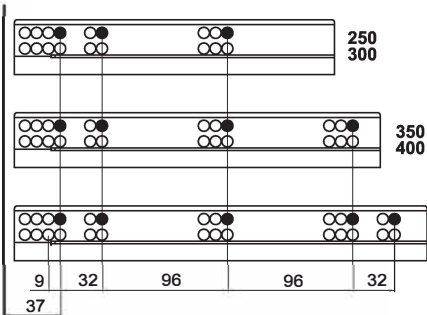

Размеры ящика  
Drawer Dimensions

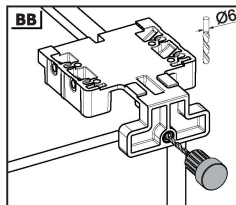
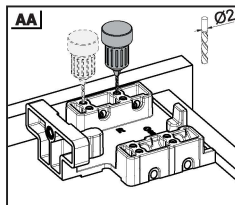
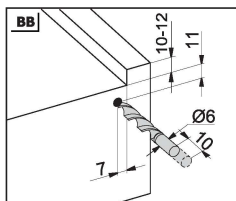
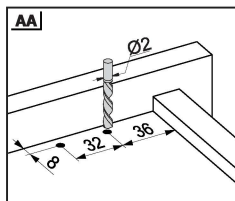
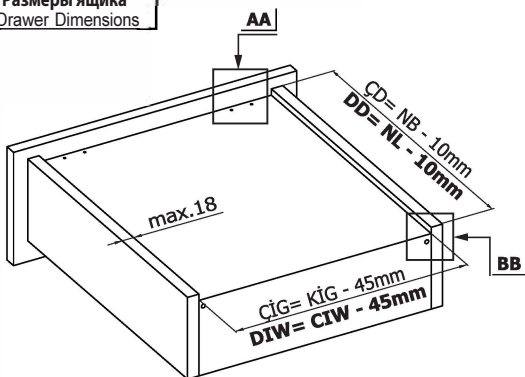

1

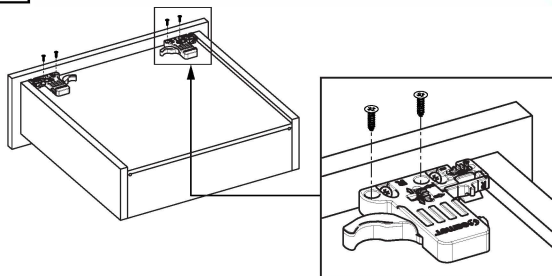

**Заметка:** Используйте угловые отверстия для установки смарт-замка, если толщина дна меньше 12 мм

**Note:** Use angled holes to mount smart lock when wooden floor width is selected less than 12 mm.

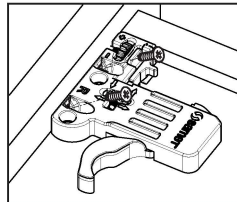
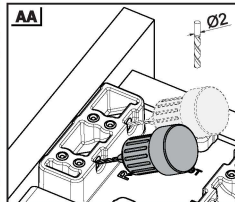

2

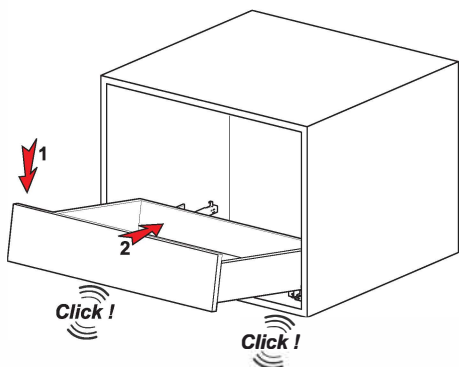

3

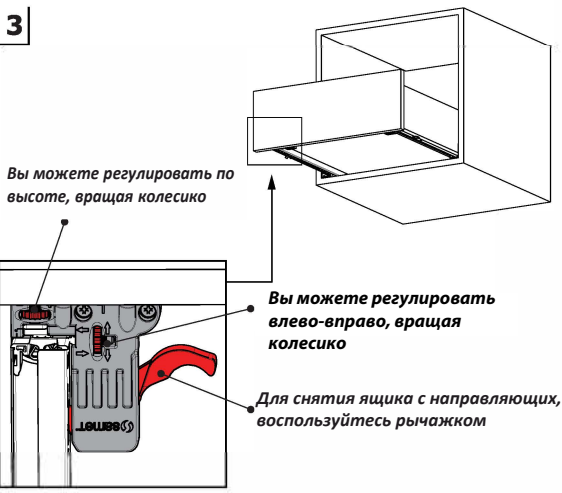

Кондуктор для сверления  
Smart Drilling Jig

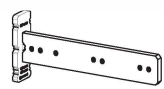

Арт. / Code
12799902
12799904

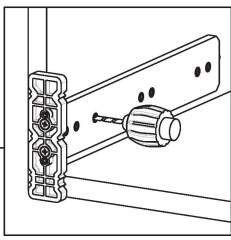
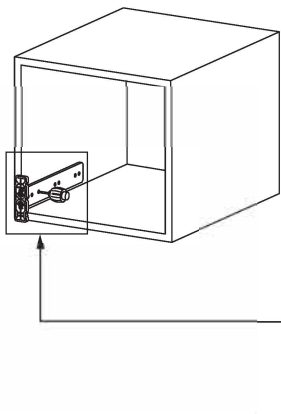

Кондуктор сверления с линейкой  
Smart Drilling Jig with Ruler

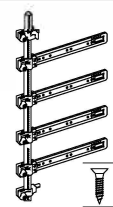

Арт. / Code
12799901
12799905

