

Addressable Fire Alarm Control Panel

Addressable Fire Alarm Control Panel

User's Manual

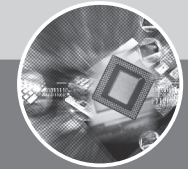

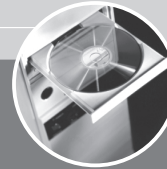



Foreword

General

This manual introduces the functions and operations of the Addressable Fire Alarm Control Panel (hereinafter referred to as "the Device").

Safety Instructions

The following categorized signal words with defined meaning might appear in the manual.

Signal Words	Meaning
 DANGER	Indicates a high potential hazard which, if not avoided, will result in death or serious injury.
 WARNING	Indicates a medium or low potential hazard which, if not avoided, could result in slight or moderate injury.
 CAUTION	Indicates a potential risk which, if not avoided, could result in property damage, data loss, lower performance, or unpredictable result.
 TIPS	Provides methods to help you solve a problem or save you time.
 NOTE	Provides additional information as the emphasis and supplement to the text.

About the Manual

- The manual is for reference only. If there is inconsistency between the manual and the actual product, the actual product shall prevail.
- We are not liable for any loss caused by the operations that do not comply with the manual.
- The manual would be updated according to the latest laws and regulations of related jurisdictions. For detailed information, refer to the paper manual, CD-ROM, QR code or our official website. If there is inconsistency between paper manual and the electronic version, the electronic version shall prevail.
- All the designs and software are subject to change without prior written notice. The product updates might cause some differences between the actual product and the manual. Please contact the customer service for the latest program and supplementary documentation.
- There still might be deviation in technical data, functions and operations description, or errors in print. If there is any doubt or dispute, we reserve the right of final explanation.
- Upgrade the reader software or try other mainstream reader software if the manual (in PDF format) cannot be opened.
- All trademarks, registered trademarks and the company names in the manual are the properties of their respective owners.
- Please visit our website, contact the supplier or customer service if there is any problem occurring when using the device.
- If there is any uncertainty or controversy, we reserve the right of final explanation.

Important Safeguards and Warnings

This section introduces content covering the proper handling of the device, hazard prevention, and prevention of property damage. Read carefully before using the device, comply with the guidelines when using it, and keep the manual safe for future reference.

Operation Requirements



- Make sure that the power supply of the device works properly before use.
- Transport, use and store the device under allowed humidity and temperature conditions.
- Prevent liquids from splashing or dripping on the device. Make sure that there are no objects filled with liquid on top of the device to avoid liquids flowing into it.
- Do not disassemble the device.

Installation Requirements



WARNING

- Strictly abide by local electrical safety standards, and make sure that the voltage in the area is steady and conforms to the power requirements of the device.
- Do not connect the device to more than one power supply. Otherwise, the device might become damaged.



- Observe all safety procedures and wear required protective equipment provided for your use while working at heights.
- Do not expose the device to direct sunlight or heat sources.
- Do not install the device in humid, dusty or smoky places.
- Install the device in a well-ventilated place, and do not block the ventilator of the device.

Maintenance Requirements



- Use the accessories suggested by the manufacturer. Installation and maintenance must be performed by qualified professionals.
- Clean the device with a soft dry cloth or a clean soft cloth dipped in neutral detergent.
- Contact your local dealer or the service center nearest to you if the device needs internal configuration or maintenance. Do not dismantle or modify the device without a qualified professional present to avoid the risk of danger or damage to the device. We will assume no responsibility for any problems caused by unauthorized modifications or maintenance.

Table of Contents

Foreword	01
Important Safeguards and Warnings.....	02
1 Product Information	05
1.1 Introduction	05
1.2 Features	05
2 Technical Information	06
3 Structure	07
3.1 Dimensions.....	07
3.2 Composition	07
3.3 Front Panel.....	08
3.4 Manual Module Panel.....	10
3.5 Device Linkage Panel.....	10
4 Device Installation and Debug	12
4.1 Packing List.....	12
4.2 Inspection	12
4.3 Installation	12
4.3.1 Principle	12
4.3.2 Wiring	13
4.3.3 Battery	13
4.4 System Debugging.....	14
4.4.1 Preparation	14
4.4.2 Device Register	14
4.4.3 Registration Check	14
4.4.4 Define.....	15
4.4.5 Simulation Experiment.....	15
5 Operation	16
5.1 Menu.....	16
5.2 Querying	17
5.2.1 Device	17
5.2.2 Log	20
5.2.3 Linkage	23

- 5.2.4 FACP Info..... 24
- 5.3 Operation..... 24
 - 5.3.1 Active & Stop 25
 - 5.3.2 Disable 26
 - 5.3.3 Log Print 26
 - 5.3.4 System Test..... 27
- 5.4 Settings..... 27
 - 5.4.1 Password..... 28
 - 5.4.2 Display 29
 - 5.4.3 Time 30
 - 5.4.4 Print 30
- 5.5 Linkage 31
 - 5.5.1 New Linkage Relation 31
 - 5.5.2 Modify Linkage Relation 33
 - 5.5.3 Delete Linkage 33
- 5.6 Debugging 33
 - 5.6.1 System 34
 - 5.6.2 User Login 35
 - 5.6.3 Register Device..... 36
 - 5.6.4 Define..... 37
 - 5.6.5 Configuration Synchronize 40
 - 5.6.6 Super Tool..... 40
- 6 FAQ.....43**
- 7 Maintenance.....45**

1

Product Information

1.1 Introduction

Addressable Fire Alarm Control Panel is designed to provide early warning fire detection, display fire information and inform people to evacuate. With two-wire and polarity-free technology, it connects with other mated products to construct a fire alarm control system. This system offers flexibility in both design and operation to meet the demands of various projects.

It is suitable for residential and industrial buildings such as hotels, shopping malls, hospitals, office buildings, schools, banks, libraries, factories, and warehouses.

1.2 Features

- Two-wire and polarity-free: The system loop line adopts two-wire and polarity-free communication power supply technology without external power supply. Strong anti-interference, convenient wiring, improved system reliability and stability, easy construction and installation, reduced project cost, and convenient maintenance.
- Intuitive display: 480 × 272 4.3" LCD screen provides a highly intuitive interface, allowing the user to fully set up the system without the need of any external tool.
- Ultra-long history record: Save historical events for a long time that can be inquired and printed in various ways such as time and type.
- Intelligent power supply: With automatic switching between the main and backup power and the charging and discharging functions, it ensures the stable power supply of the system to the greatest extent.
- Flexible linkage logic: The logic programming is flexible, which can realize a variety of customized linkage requirements, simple and convenient programming, and reduced debugging workload.
- Protection design: Short circuit, open circuit and overcurrent protection to ensure stable operation.

2 Technical Information

Parameter	Introduction
Working Voltage	16V DC ~28V DC
System Capacity	200 field devices
Main Power Supply	AC 90-240V/50Hz, 60Hz
Backup Power Supply	2 lead-acid batteries(12V/5Ah each)
Display	480 × 272 4.3" LCD screen
Printer	Micro thermal printer
Dimensions (with base)	333.0 mm×115.0 mm×480.0 mm (13.11" × 4.53" × 18.90")
Operating Temperature	-10°C to +40°C (+14°F to +104°F)
Operating Humidity	≤ 95% RH (no condensation)
Protection	IP30

3 Structure

3.1 Dimensions

Figure 3-1 Dimensions (mm[inch])

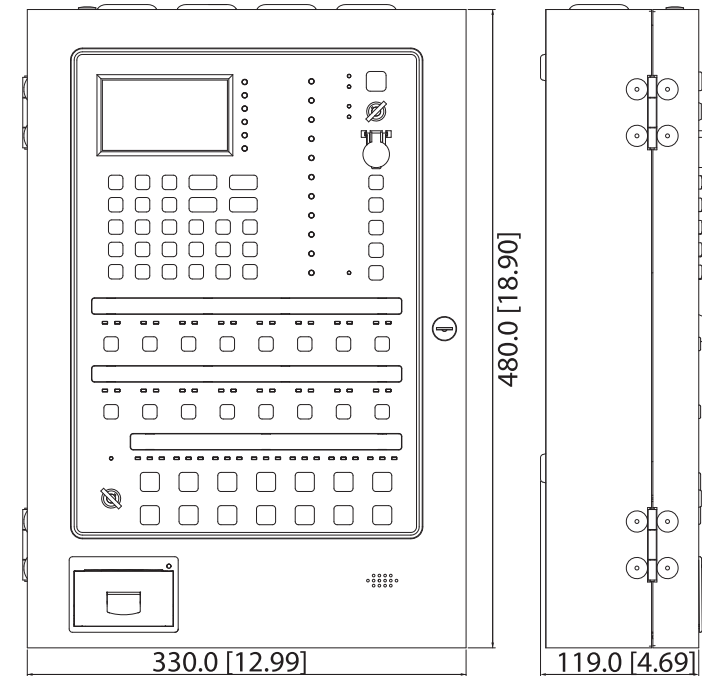

3.2 Composition

- Single loop: 200 devices
- Manual module panel: 16 buttons to start field devices
- Direct linkage panel: 14 buttons to control fire alarm devices
- 1 Alarm Output: DC24V
- 1 Fault Output: DC24V
- RS-485: Enable connection with control module
- CANH, CANL: Enable communication with other control panel
- DC24V: DC24V/300mA outputs to field devices

3.3 Front Panel

Figure 3-2 Front panel

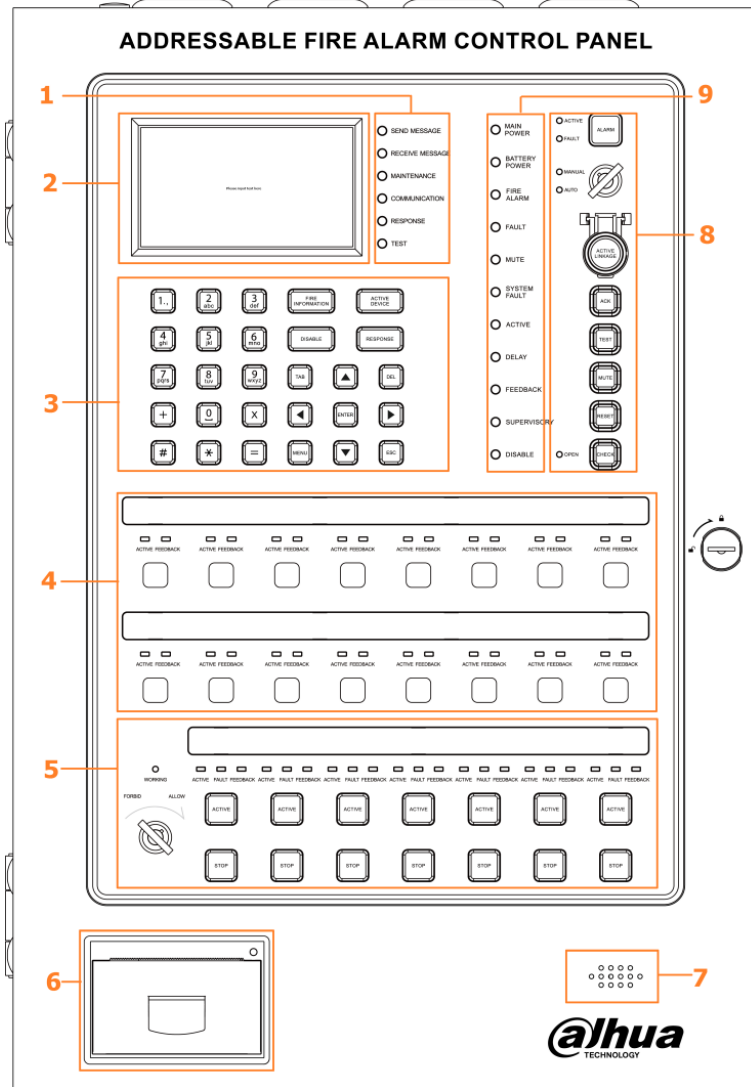

Table 3-1 Front panel introduction

No.	Introduction
1	<ul style="list-style-type: none"> Send message: Remain lit when control panel sends message. Receive message: Remain lit when control panel receives message. Maintenance: Remain lit when control panel is in maintenance mode. Communication: Remain lit when control panel connects to other panels. Response: Remain lit after the key is pressed. Test: Remain lit when control panel is in self-test mode.
2	Display operation screen.
3	<ul style="list-style-type: none"> ↑, ↓, ←, →: Turn pages or navigate between the options on the screen. Enter: Enter the selected menu and confirm operations. Numerical and alphabetic keys: Enter numbers, letters and marks. Fire Message: Search fire alarm information. Active Device: Enter active/stop menu. Disable: Disable/enable device. Tab: Change the display among different windows when there are multiple messages. Menu: Enter main menu. Esc: Exit from the current menu or return to the previous menu. Delete: Delete the input. +, x, *, #: Edit linkage relation.
4	Manual module panel
5	Device linkage panel
6	Print various event information such as fire alarm, fault, startup and feedback. The information content includes event type, device information and occurrence time. The paper is installed by default. If the printing paper is exhausted, you can purchase and install thermal printing paper. For details, see "7 Maintenance".
7	Alarm sound outlet.
8	<ul style="list-style-type: none"> Active linkage: Start linkage signal in accordance with the reset logic. ACK: Confirm the received fault and alarm information, and identify the confirmed information. Test: Test the LCD, speaker and all LEDs. Mute: Silence the speaker of the panel. Reset: Reset the panel. Check: Check the relevant information of the panel.

No.	Introduction
9	<ul style="list-style-type: none"> ● Main power: Remain lit for AC220V power on. ● Battery power: Remain lit for backup battery on. ● Fire alarm: Remain lit after receiving fire information. The LED turns off when the panel is reset. ● Fault: Remain lit when a trouble condition is detected. The LED turns off when the panel is reset or the fault is addressed. ● Mute: Remain lit when the speaker is silenced. If there is new fire alarm, the speaker will be re-activated and this LED will turn off. ● System fault: Remain lit when the memory of the panel is in trouble or system program cannot be executed. ● Active: Remain lit when the panel sends active command. The LED turns off if no feedback signal is received within 10s of sending the start command. ● Delay: Remain lit when there is a sounder or an output in delay mode. The LED turns off when the delay time expires. ● Supervisory: Remain lit when there is supervisory signal. The LED turns off when the panel is reset. ● Disable: Remain lit when there is a connected device or an output or the delay mode is disabled. ● Manual: Remain lit when the panel is in manual state. ● Auto: Remain lit when the panel is in auto state.

The device linkage panel realizes direct control of field devices through input and output modules.

Figure 3-4 Device linkage panel

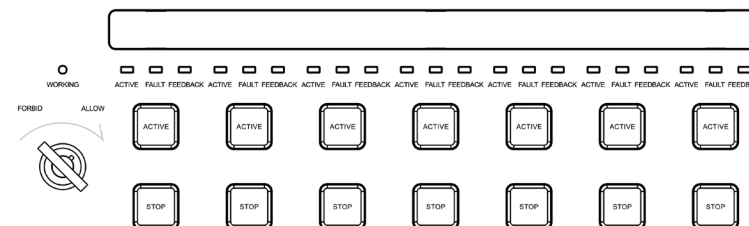

3.4 Manual Module Panel

Control field devices. Each group controls 1 button and 2 indicator lights.

Figure 3-3 Manual module panel

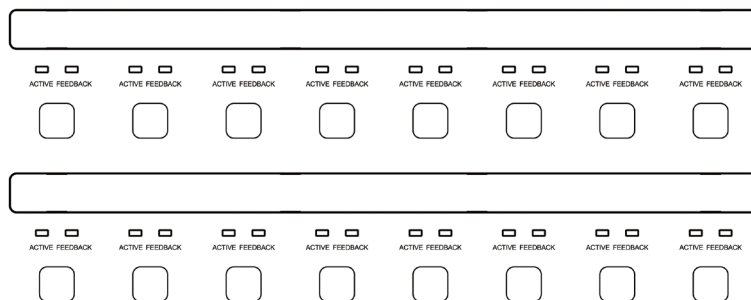

3.5 Device Linkage Panel

The device linkage panel is used to control fire pumps, smoke exhausters, blowers, etc. The address of the device linkage panel can be adjusted according to the switch, and the address can be set from 1 to 14. The device linkage panel can directly control fire equipment when the main control system is paralyzed.

Each group of outputs of the device linkage panel has the function of open circuit and short circuit fault detection, which can maximize the reliability of the connection between the device linkage panel and fire equipment. Each device linkage panel has a total of 7 control groups. Each control group has 2 buttons and 3 indicator lights.

4 Device Installation and Debug

4.1 Packing List

Check the package according to the following checklist. If you find anything damaged or lost, contact customer service.



Keep accessories properly for future use.

Table 4-1 Checklist

Item	Quantity
Addressable fire alarm control panel	1
User's manual	1
Key	2
Key to the FACP	2
Backup insurance	2
Button label	3
Printer paper	1

4.2 Inspection

- Do not power the system until the installation is completed.
- The Addressable Fire Alarm Control Panel receives main power from 90V-240V supply. The positive and negative poles of the backup battery are correctly connected.
- Turn on the backup battery first and then the main power (turn off the main power first and then the backup battery).
- The voltage of the manual module panel and device linkage panel terminals should be about 27V.
- Carry out self-test to check whether all parts are successfully inspected.
- The defective detectors should be dealt with according to "FAQ" and "Maintenance", and then test again. If it still fails to pass the test, it should be returned to the factory for repair.

4.3 Installation

4.3.1 Principle

- The FACP adopts wall-mounted installation. It should be installed in the fire control room or the place where people are on duty. Keep away from the environment with electromagnetic interference.
- The design should be strictly implemented in accordance with relevant provisions and regulations, and connect the device correctly according to the construction drawing.

4.3.2 Wiring

Before connecting the signal line and direct control line to the FACP, the insulation test should be carried out.

The insulation resistance between loops is more than 10 KΩ, and insulation resistance between loops and ground is more than 10 MΩ.



Do not measure the line resistance of the installed device by a megger.

Figure 4-1 Wiring terminal

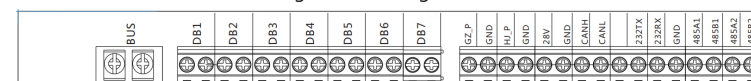

Bus terminal

BUS: Connect detector, module, sounder strobe, etc.

Device linkage panel terminal

DBn (n=1-7) : Control fire pumps, smoke exhausters, blowers, etc.

Other terminal

- GZ_P, GND: Fault output, DC24V.
- HJ_P, GND: Fire alarm output, DC24V.
- 28V, GND: Power output, DC28V.
- CANH, CANL: Connect to other FACP.

Main electrical terminal

L、N、 : AC 110 V ~ 220V power supply.

4.3.3 Battery



Connect the final battery after completing installation.

Step 1 Connect fuse.

Step 2 Connect the red and black power wires reserved in the wire slot to the positive and negative terminals of the battery respectively.

Figure 4-2 Battery

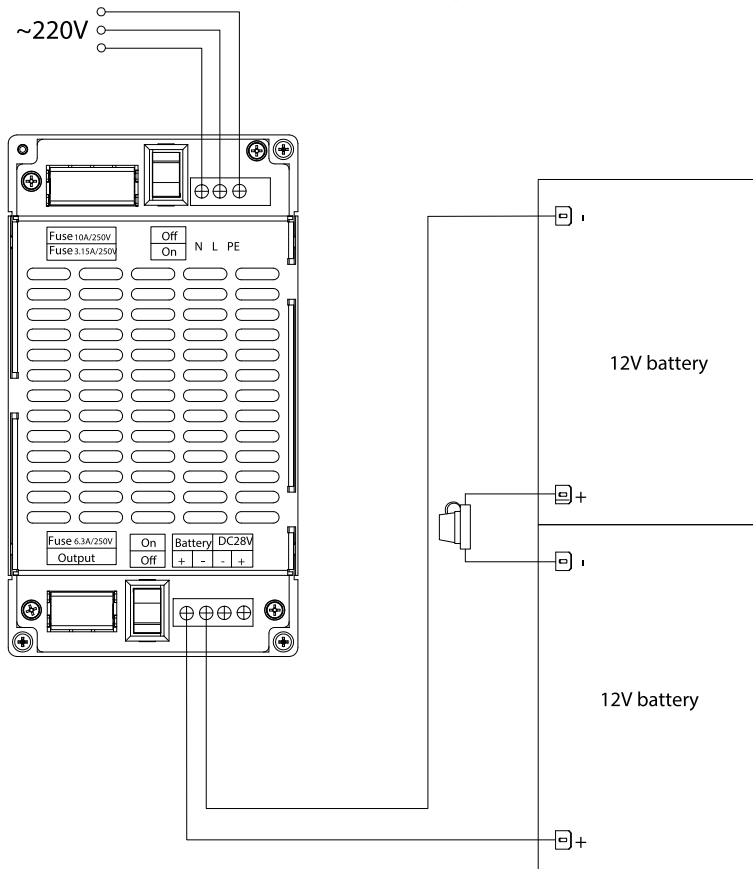

4.4 System Debugging

4.4.1 Preparation

After connection and verification, the system may be switched on for debugging, mainly including logging and testing of detector and module, and setup of linkage relation.

4.4.2 Device Register

Select **Debugging > Register Device** to register the field devices. For the specific operation method, please see 5.6.3 Register Device.

4.4.3 Registration Check

After the device is successfully registered, check the login result and network state. For details of the field device query, please see 5.2.1 Device.

4.4.4 Define

After ensuring that all the devices are registered and online, define the field device, including the user code, description information and device parameters, and set the manual module panel and device linkage panel. For details, please see 5.6.4 Define.

4.4.5 Simulation Experiment

Simulate alarm test. If Addressable Smoke Detector, Addressable Manual Call Point and Addressable Sounder Strobe work normally, test the panel function by pressing Addressable Manual Call Point or simulating fire alarm by Addressable Smoke Detector. The fire light is lit and alarm is triggered representing that the fire function is normal. After completing testing start/stop function, and defining manual module panel and device linkage panel, the manual module panel and device linkage panel button can be used to fast start and stop field devices.

5

Operation

This chapter introduces the operations included in the main menu.

It consists of many menus for management and programming operations. They are as below:

- Querying
- Operation
- Settings
- Networking
- Linkage
- Debugging

5.1 Menu

The main menu of FACP includes querying, operation, settings, networking, linkage and debugging.

- When there is neither fire alarm nor other event information, the interface shows that the system is working normally.

When the system is in normal state, press **Menu** to enter the main menu interface.

Figure 5-1 Menu

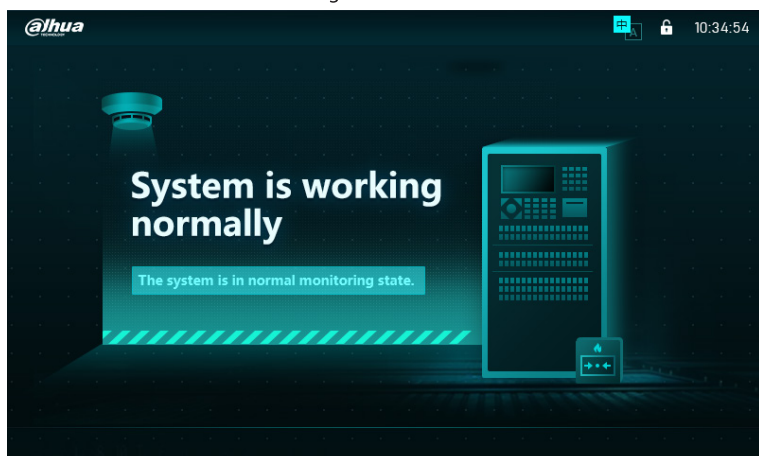
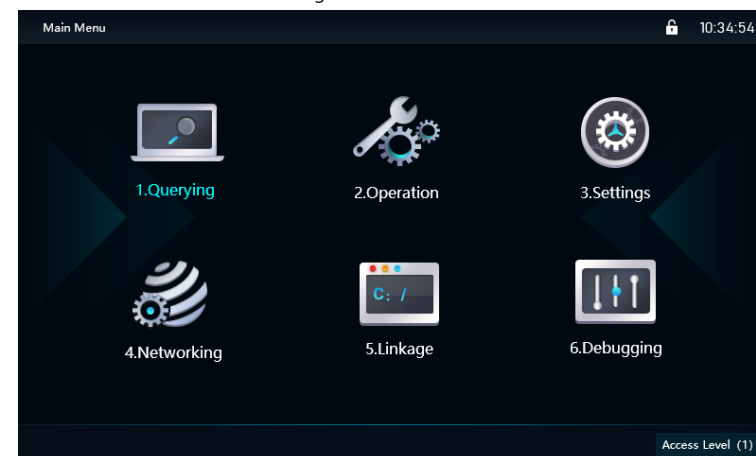

Figure 5-2 Main menu



- When there is alarm, the interface displays alarm information.

1. Press **↑** and **↓** to select event.
2. Press **←** and **→** to see brief information of all events.
3. Press **Enter** to see information in details.

5.2 Querying

Press **Menu** to enter the **Querying** interface, including Device, Log, Linkage and FACP information.

Figure 5-3 Querying

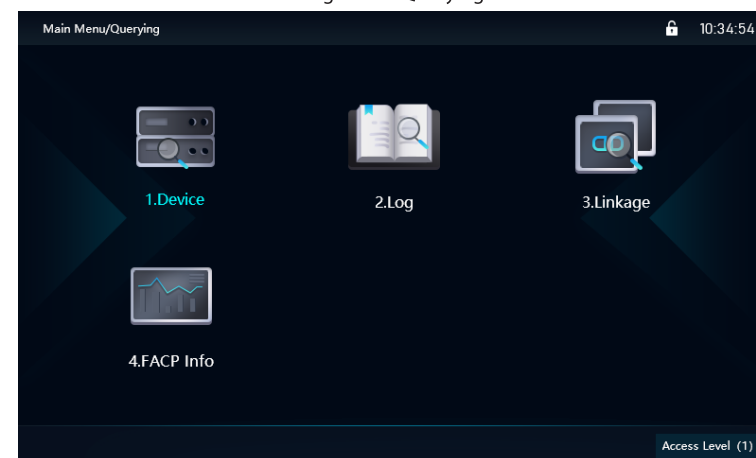

5.2.1 Device

Select **Querying > Device**, to see the information of all devices in details. Support

the query by loop, by type and by address. Query information including S/N, user number, logic address, description and parameters.

Figure 5-4 Device

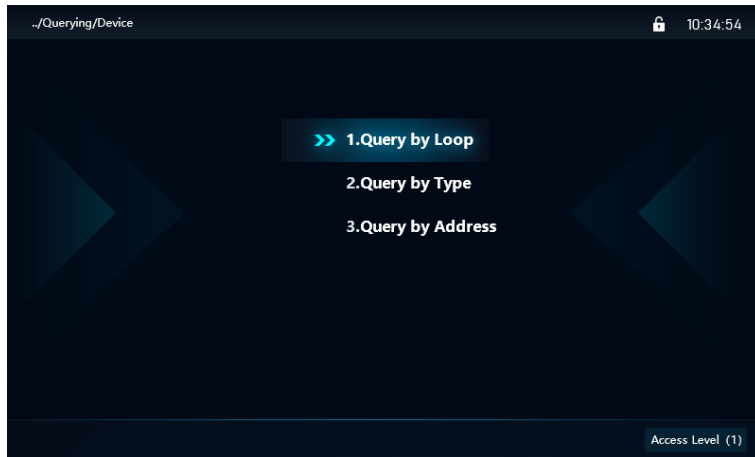

5.2.1.1 Query by Loop

Step 1 Select **Querying > Device > Query by Loop**.

Figure 5-5 Query by loop

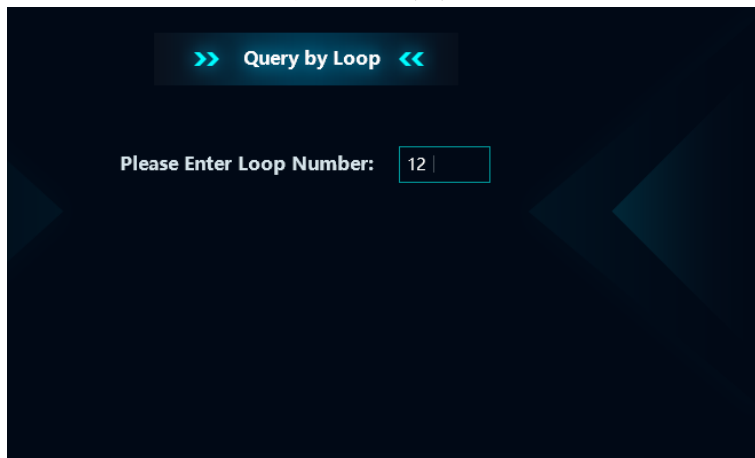

Step 2 Enter **Loop Number**, and press **Enter**.

See the brief information of all devices in this loop.

Figure 5-6 Devices information

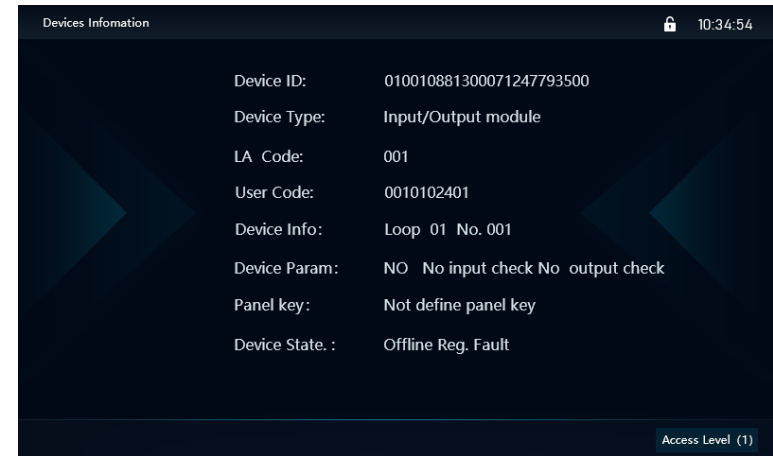

5.2.1.2 Query by Type

Step 1 Select **Querying > Device > Query by Type**.

Step 2 Enter **Type Number**, and press **Enter**.

See the brief information of all devices with same type.

Figure 5-7 Query by type

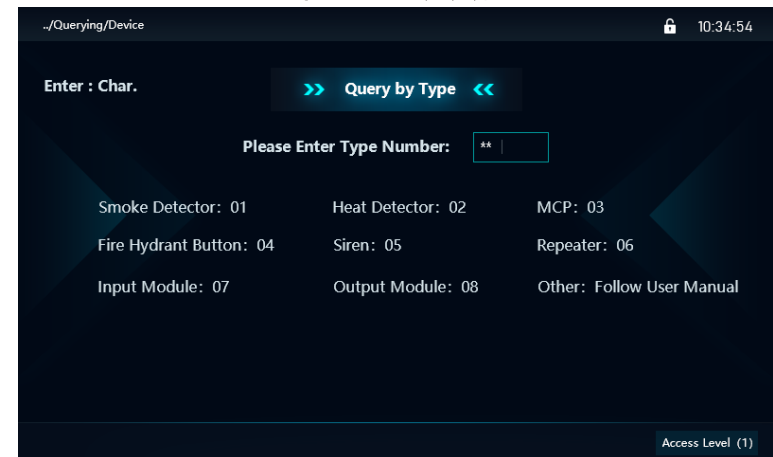

Step 3 Press **↑** or **↓** to select target device, and press **Enter**.

See detailed information of this target device.

5.2.1.3 Query by Address

Step 1 Select **Querying > Device > Query by Address**.

Step 2 Enter Loop Number and Logic Address, and press **Enter**.

See the brief information of all devices with same address.

Figure 5-8 Query by address

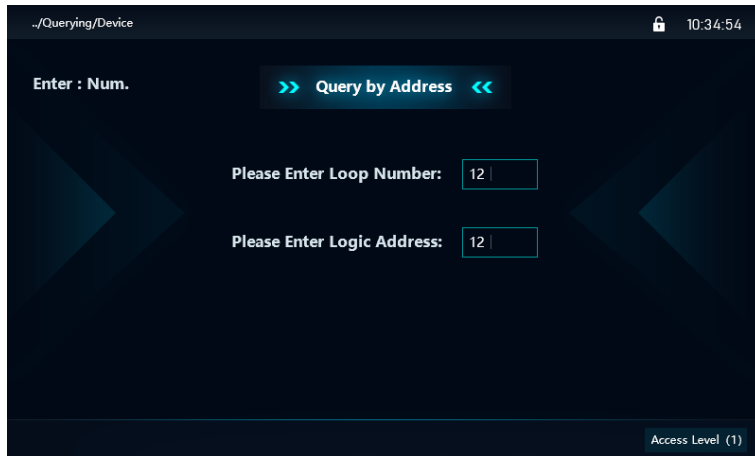

Step 3 Press \uparrow or \downarrow to select target device, and press **Enter**.
See detailed information of this target device.

Figure 5-9 Address list

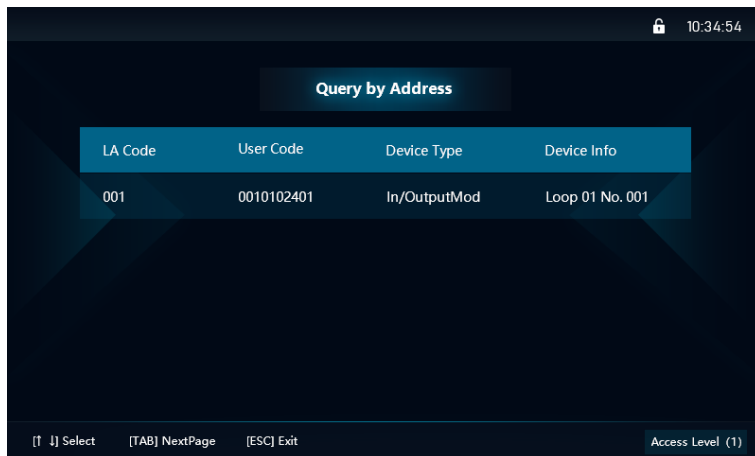

5.2.2 Log

Select **Querying > Log**, to see the **FACP Log** and **Network Log**, including fire, fault, start, feedback and supervisory. It can keep 5000 pieces of information at most.

Figure 5-10 Log Query

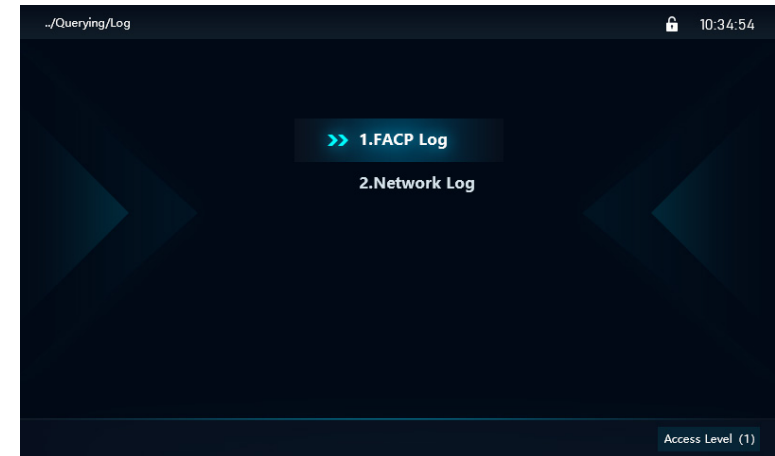

5.2.2.1 FACP Log

See the fire, fault logs. Support query by time, type, device and address.

Step 1 Select **Querying > Log Query > FACP Log**.

Figure 5-11 FACP log

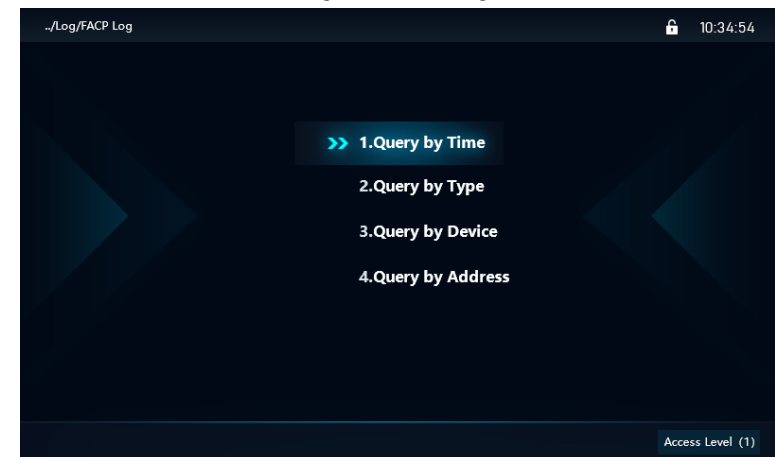

Step 2 Select query type, and press **Enter**.

See the brief information of all devices in this loop.

- Query by Time: Displays a record of all events according to the latest event occurrence time.

Figure 5-12 Query by time

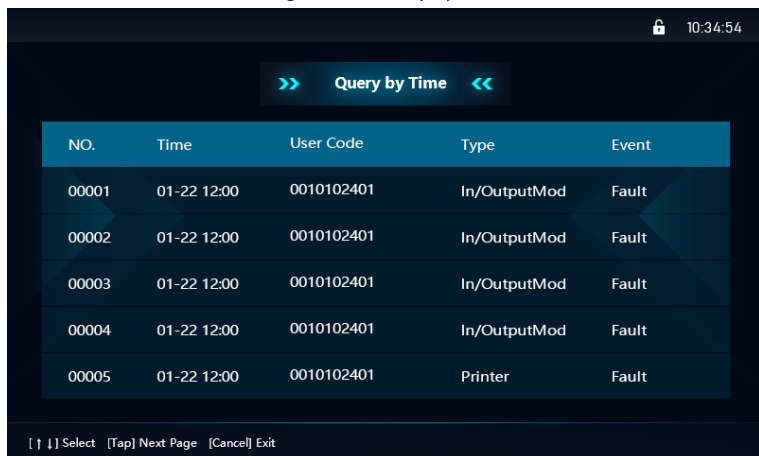

- Query by type: Displays all records of the same type of event according to the latest event occurrence time. Enter the record type number, press **Enter** to view all fault events.

Table 5-1 Type number

Type Number	Event type
Fire Alarm	00
Supervisory	01
Active	02
Feedback	03
Delay	04
Fault	05
Disable	06

- Query by device: Displays all records of the device according to the latest event occurrence time.
- Query by address: Displays the historical event records of a logic address device in a loop. Enter the loop number and logic address of the target device, and press **Enter** to view the historical record information of the device.

Step 3 Press **↑** or **↓** to select target device, and press **Enter**. See detailed information of this target device.

Figure 5-13 Record information

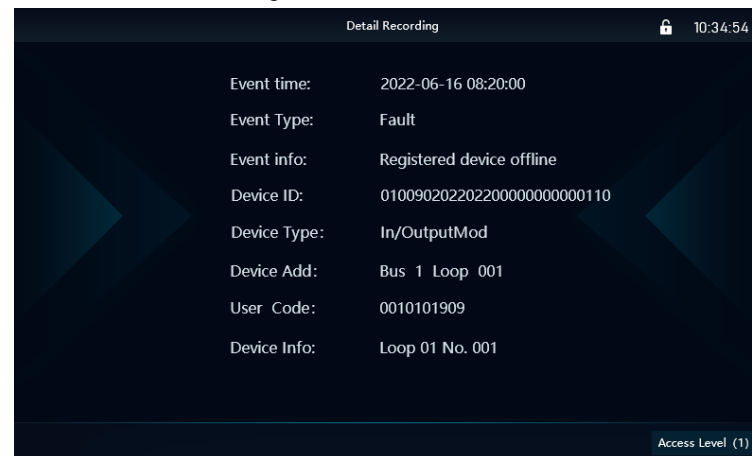

5.2.2.2 Network Log

Display event information transmitted to this FACP by other panels in the network. The operation is similar to querying FACP Log, please refer to 5.2.2.1 FACP Log.

5.2.3 Linkage

Linkage includes query by linkage relation, query linkage info on manual module panel and query linkage info on device linkage panel.

Figure 5-14 Linkage

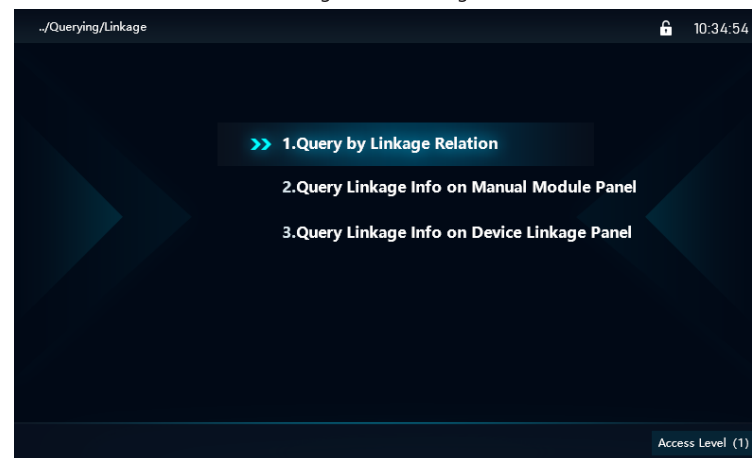

5.2.3.1 Query by Linkage Relation

Step 1 Select **Querying > Linkage > Query by Linkage Relation** to see linkage relation.

Step 2 Press ↑ or ↓ to select target linkage relation, and press **Enter**.

See detailed information of this linkage relation.

5.2.3.2 Query Linkage Info on Manual Module Panel

Select **Querying > Linkage > Query Linkage Info on Manual Module Panel** to see information of manual module panel.

5.2.3.3 Query Linkage Info on Device Linkage Panel

Select **Querying > Linkage > Query Linkage Info on Device Linkage Panel** to see information of device linkage panel.

5.2.4 FACP Info

FACP Info includes project information query, project information settings and version information.

Figure 5-15 FACP Info

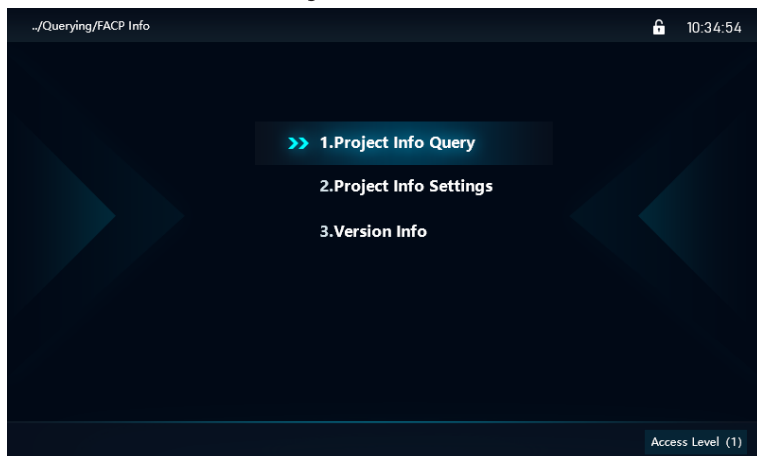

5.2.4.1 Project Information Query

Select **Querying > FACP Info > Project Info Query** to see detailed information of this project, for example, project name, project address, contact, and telephone.

5.2.4.2 Project Information Settings

Select **Querying > FACP Info > Project Info Settings** to set project name, address, contact, and telephone.

5.2.4.3 Version Information

Select **Querying > FACP Info > Version Info** to see the hardware / software version of FACP and FACP ID.

5.3 Operation

Press **Menu** to enter the **Operation** interface, including Active & Stop, Disable, Log Print and System Test.

Figure 5-16 Operation

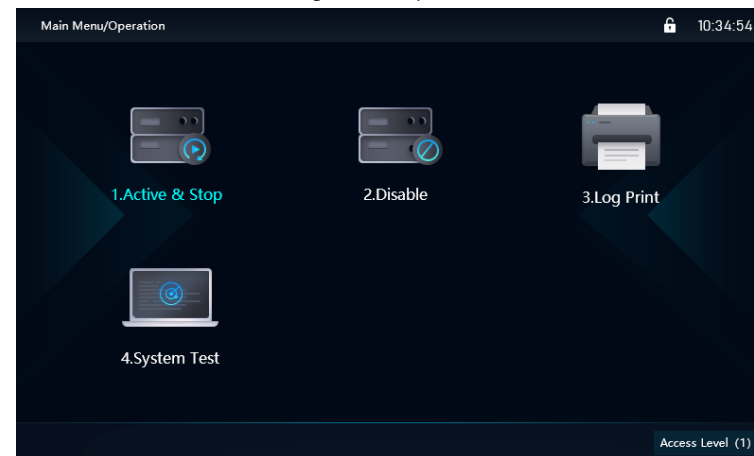

5.3.1 Active & Stop

Active & Stop menu includes active / stop device by user code, and active / stop device by logic address.



Active & Stop operations can only active and stop devices that support startup commands and are registered online. If the device is not registered online, when the device is activated, it will prompt that the device is offline. After the device is normally registered and online, the Active & Stop operations can respond normally.

Figure 5-17 Active & Stop

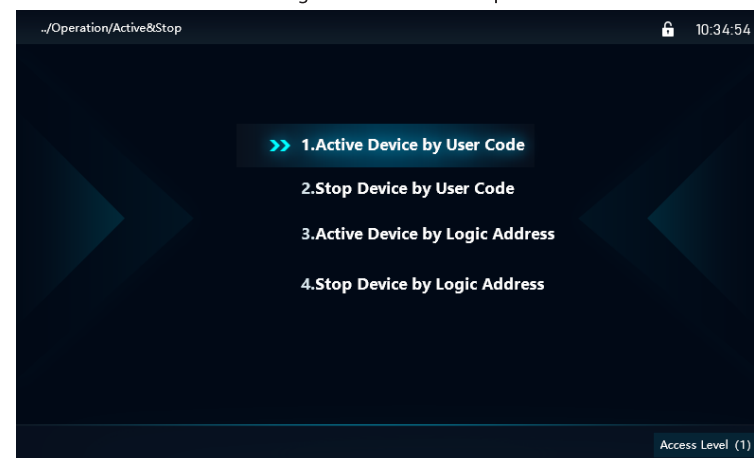

The active and stop operation is similar. The following uses the user code to active the device as an example.

Step 1 Select **Operation > Active & Stop > Active Device by User Code**.

Step 2 Enter user code, and press **Enter**.

Activate this device.

5.3.2 Disable

Disable operation is used for faulty field devices that are not able to be repaired in time. In such cases, they should be isolated temporarily and released after the problems are resolved. Devices can be disabled or enabled by user code and logic address.

Figure 5-18 Disable

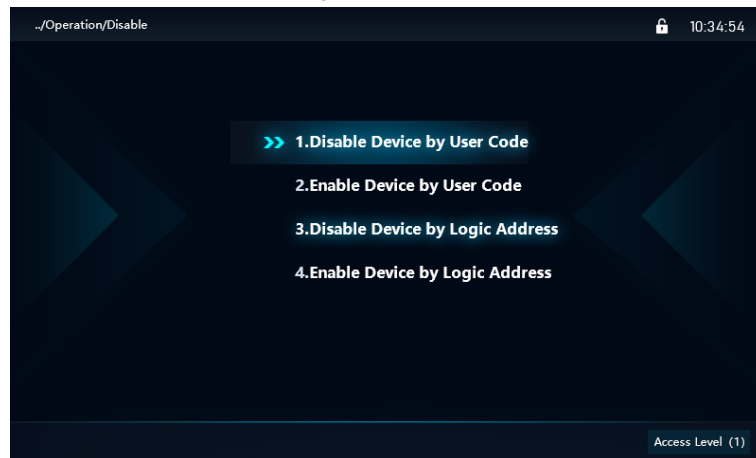

The operation method of disabling device is similar. The following takes isolating a device by user code as an example.

Step 1 Select **Operation > Disable Setting > Disable Device by User Code**.

Step 2 Enter user code, and press **Enter**.

Disable this device.

5.3.3 Log Print

Print the specified event information for the specified time period.

Step 1 Select **Operation > Log Print**.

Step 1 Select the event type to be printed.

Step 2 Enter Start time and End time, and press **Enter**.

Print the recode of this event type during this period.

Figure 5-19 Print by time & type

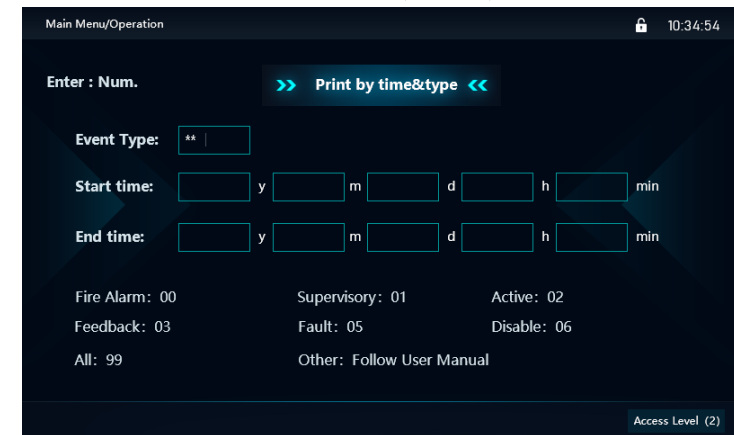

5.3.4 System Test

In the process of system debugging, in order to check whether the FACP works normally, the self-test can be carried out. When the FACP is in self-test state, main control board, indicator light, speaker, flash memory, printer, and LCD are tested respectively.

Step 1 Select **Operation > System Test** or press **Test**.

FACP is in self-test mode, the Test LED is constantly on.

Press **Esc** to cancel the test process.

Step 2 After completing self-test, the Test LED turns off.

5.4 Settings

Press **Menu** to enter **Settings** interface, including Password, Display, Time, and Print.

Figure 5-20 Settings

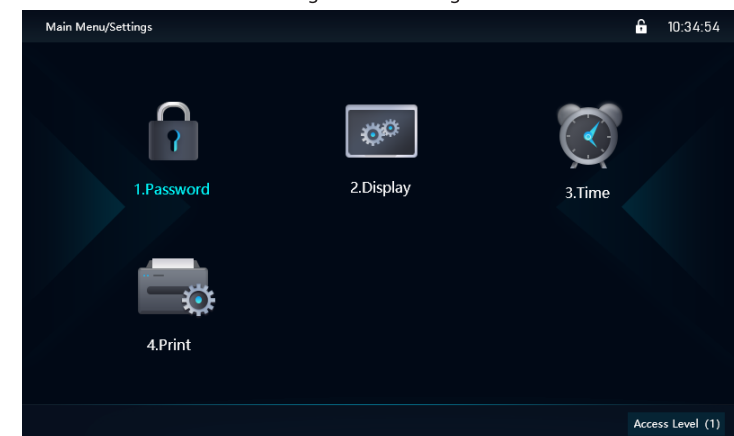

5.4.1 Password

Password Setting includes setting the system operator password, administrator password, and super user password. Different operations require different minimum operation authorities, and high-level authority has the right to perform low-level authority operations. Enter the password first to obtain the operation authority, among which the system default first-level operation authority does not require a password.



The passwords for all levels of operation authority should be kept secret by specialized personnel. After the user completes the operation, the panel keyboard should be locked to restore the operation authority to the first level, so as to prevent unrelated personnel from operating the panel.

Figure 5-21 Password setting

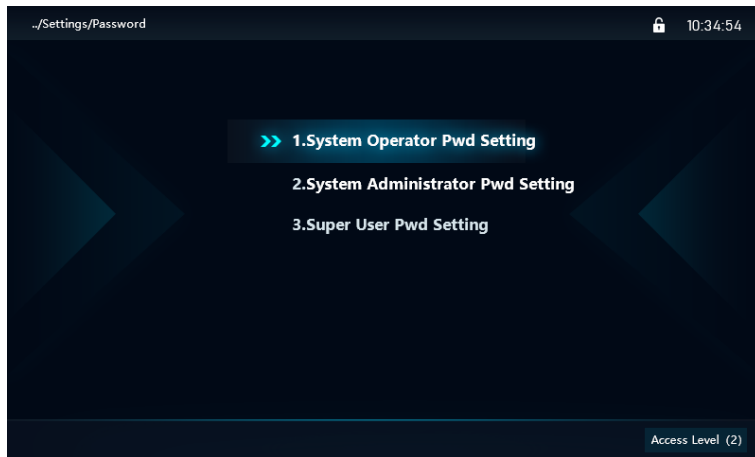

5.4.1.1 System Operator Password Setting

The system operator can only perform basic common operations such as system viewing, muting, and resetting. There is no password by default.
Step 1 Select **Settings > Password Setting > System Operator Password Setting**.
Step 2 Enter old password. Enter new password and then confirm it.
Step 3 Press **Enter** to save the new password.

5.4.1.2 System Administrator Password Setting

System administrator can perform operations such as registration, definition, and linkage programming for loop devices. There is no password by default. To set the system administrator password, please refer to 5.4.1.1 System Operator Password Setting.

5.4.1.3 Super User Password Setting

When the manufacturer replaces the core device, the super user password is required, and the password is not open to the user.

5.4.2 Display

Set the brightness of the LCD screen of the panel as well as the update time of the lock screen, the cursor update time, and the unattended exit update time when the panel is not operated.

Figure 5-22 Display setting

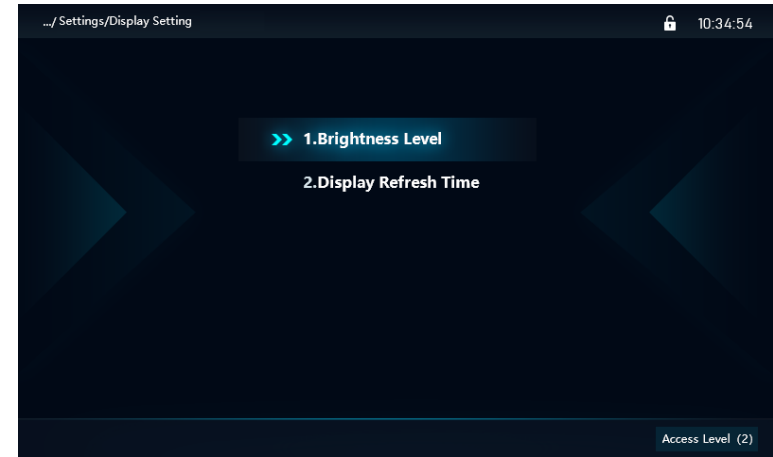

5.4.2.1 Brightness Level

Step 1 Select **Settings > Display Setting > Brightness Level** to set brightness.
Step 2 Press ← or → to adjust brightness. The setting is automatically saved when it is completed.

Figure 5-23 Brightness level

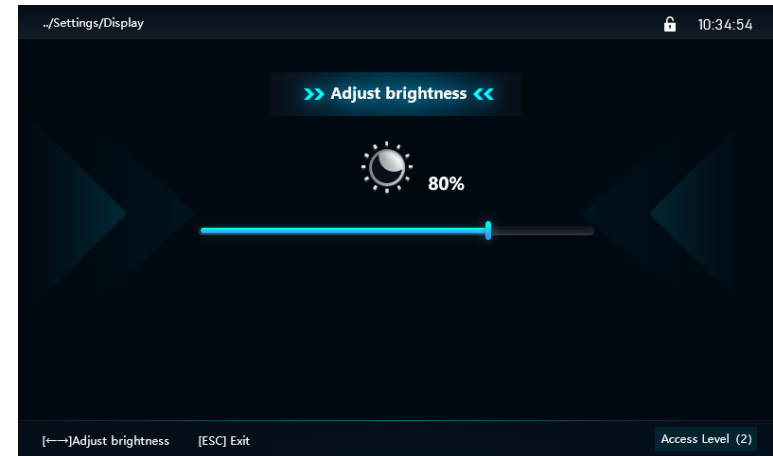

5.4.2.2 Display Refresh Time

Step 1 Select **Settings > Display Setting > Display Refresh Time**.

Step 2 Press ← or → to adjust refresh time and enter number. Press **Enter** to save the setting.

5.4.3 Time

Step 1 Select **Settings > Time**.

Step 2 Enter time and press ← or →.

Press **Enter** to save time setting.

Figure 5-24 Time

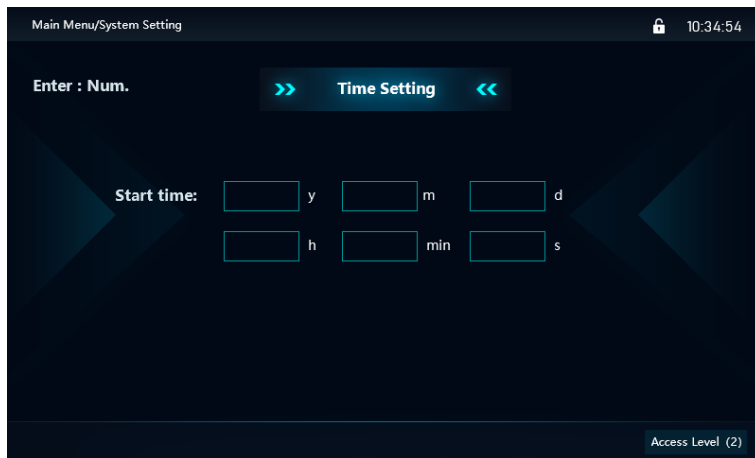

5.4.4 Print

When the event with designated type occurs, the information is printed automatically.

Step 1 Select **Settings > Print**.

Step 2 Select print types, and press **Enter**.

Figure 5-25 Printer Setting

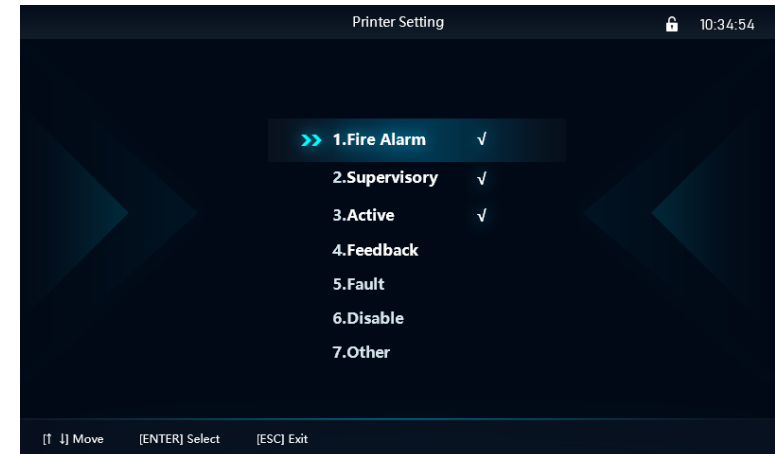

5.5 Linkage

Press **Menu** to enter **Linkage** interface, including New Linkage Relation, Modify Linkage Relation and Delete Linkage.

Figure 5-26 Linkage programming

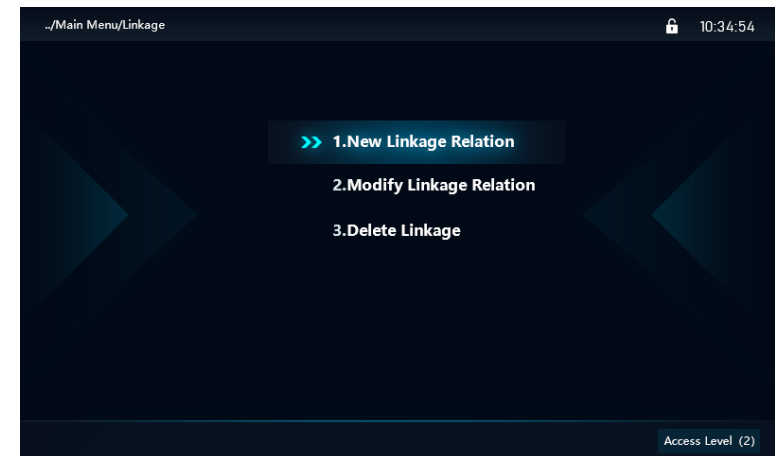

5.5.1 New Linkage Relation

The linkage relation consists of input items and output items, which are connected by "=". Each input and output item consists of a user code and a four-digit suffix.

Step 1 Select **Linkage > New Linkage Relation**.

Step 2 Edit linkage relation.



The four-digit suffix of the input item will automatically pop up to match the device type. The first two digits of the four-digit suffix of the output item are 01, and the last two digits are the delay time (hexadecimal).

Step 3 Press **Enter** to keep settings.

Figure 5-27 New linkage relation

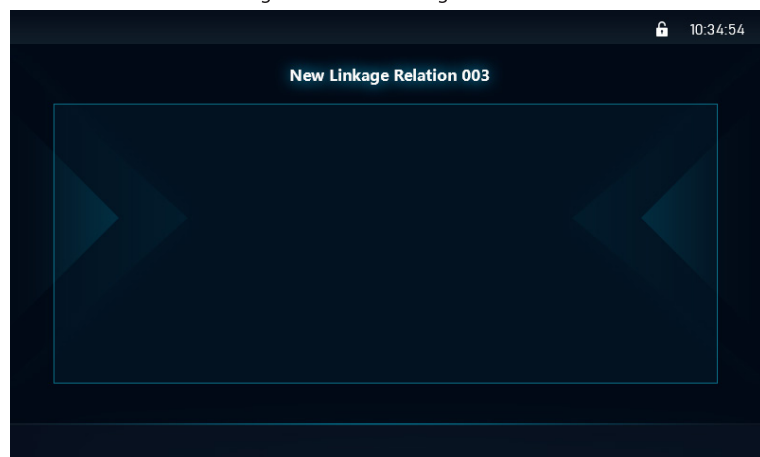







Table 5-2 Symbol introduction

Symbol	Introduction
×	And.
+	Or.  It can only appear in input part.
=	The left part of "=" is the input part. When there are multiple input items, each input item is connected by "×" or "+", the logical symbol "×" stands for "and", and "+" stands for "or", "+" can only appear in the input part. The right part of "=" is the output part. When there are multiple output items, each output item is connected by "×".  TIPS To realize the two fire alarm signals sent by 1st smoke detector and 2nd addressable manual call point on the Floor 3, Unit 2, Building 1, activate 4th addressable sounder strobe and delay 6 seconds to start 5th input / output module on the Floor 3, Unit 2, Building 1, the linkage relation is: 01203 001 01 4002 × 01203 002 03 0100=01203 004 05 0100 × 01203 005 09 0106.  The definition of numbers can be customized.

Symbol	Introduction
*	Represents any number between 0 and 9.  TIPS To realize the two fire alarm signals sent by smoke detector and addressable manual call point on the Floor 3, Unit 2, Building 1, activate all addressable sounder strobes and delay 6 seconds to start all input / output modules on the Floor 3, Unit 2, Building 1, the linkage relation is: 01203 *** 01 4002 × 01203 *** 03 0100=01203 *** 05 0100 × 01203 *** 09 0106.
#	Indicates that the user code is consistent in the same position and must appear in the same position in all input user codes or output user codes.  TIPS To realize the two fire alarm signals sent by smoke detector and addressable manual call point on the same floor of the same unit in Building 1, activate all addressable sounder strobes and delay 6 seconds to start all input / output modules on the same floor of the same unit in Building 1, the linkage relation is: 01### *** 01 4002 × 01##### 03 0100=01### *** 05 0100 × 01### *** 09 0106.

5.5.2 Modify Linkage Relation

While system debugging or device replacing, modify the linkage relation according to the actual situation.

Step 1 Select **Linkage > Modify Linkage Relation**.

Step 2 Modify the linkage relation.

Step 3 Press **Enter** to keep settings.

5.5.3 Delete Linkage

When the linkage relation is not applicable, the linkage relation can be deleted.

Step 1 Select **Linkage > Delete Linkage**.

Step 2 Delete the linkage relation.

Step 3 Press **Enter** to keep settings.

5.6 Debugging

Press **Menu** to enter **Debugging** interface, including System, User Login, Register Device, Register Network, Define, Configuration Synchronization and Super Tool.

Figure 5-28 Debugging (1)

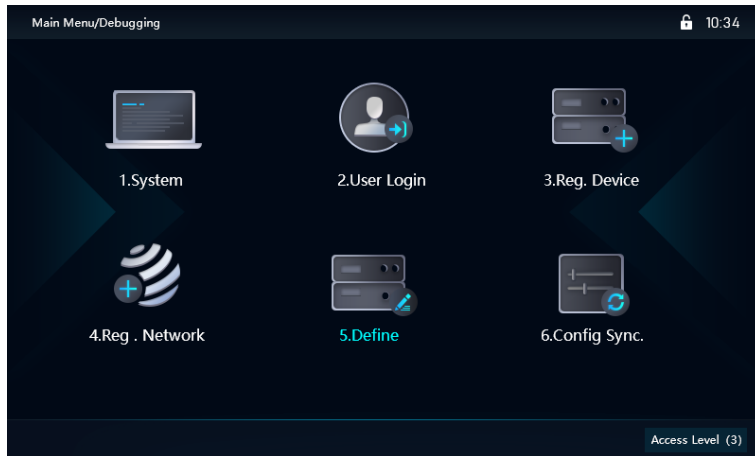
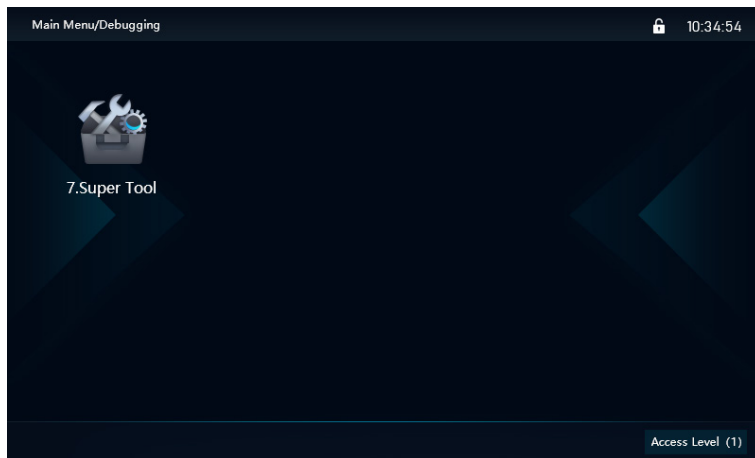

Figure 5-29 Debugging (2)



5.6.1 System

Step 1 Select **Debugging > System**.

Figure 5-30 System Mode

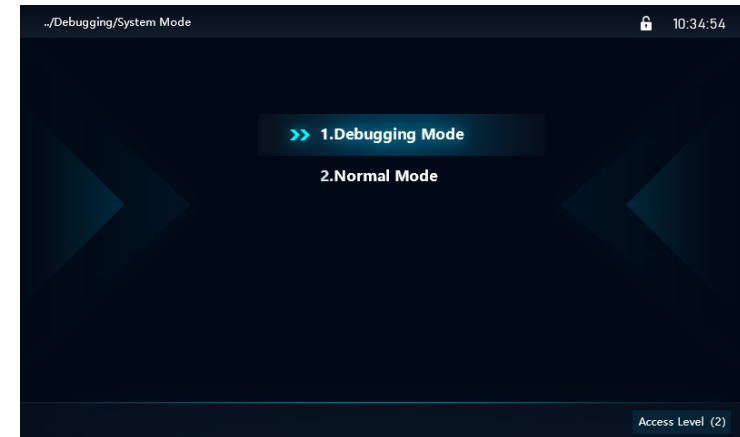

Step 2 Select system mode.

- Select **Debugging Mode**: When FACP is in debugging and maintenance mode, the LCD does not display fault information and Maintenance LED flashes.
- Select **Normal Mode**: When FACP is in debugging and maintenance mode, the LCD displays fault information and Maintenance LED turns off.

Step 3 Press **Enter** to keep settings.

5.6.2 User Login

Step 1 Select **Debugging > User Login**.

Step 2 Select login mode, and press **Enter**.

Enter the password, and press **Enter** to obtain corresponding operation authority.

Figure 5-31 User Login

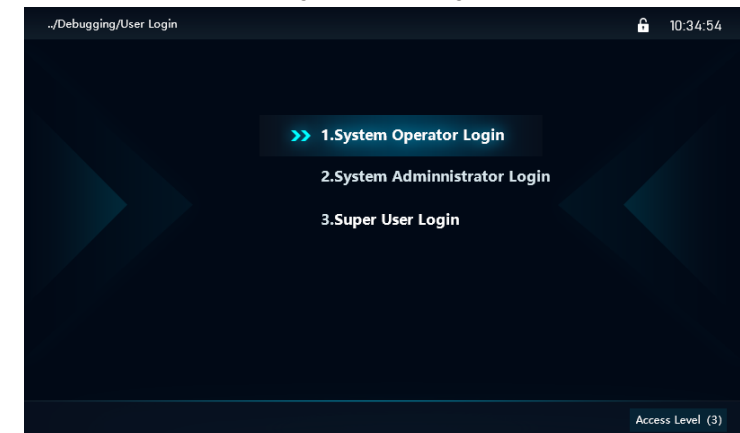

Table 5-3 Operation

No.	Operation	I	II	III	IV
1	Query information	M	M	M	M
2	Mute device	M	M	M	M
3	Rest	P	M	M	M
4	Manual control	P	M	M	M
5	Test, isolate mode	P	M	M	M
6	Set time	P	M	M	M
7	Power on/off	P	M	M	M
8	Enter or modify data	P	P	M	M
9	Set delay mode	P	P	M	M
10	Programming	P	P	M	M
11	Modify or change software/hardware	P	P	P	M



- P is prohibited, M is allowed.
- Keys and operation numbers are required to enter the state of level II and level III operation functions. The key or number of operations used to enter the state of level III operation can be used to enter the state of level II operation functions, but the keys or number of operations used for level II operation state cannot be used. After entering the state of level III and level IV operation function.

5.6.3 Register Device

It includes register device in loop and channel registration of device linkage panel.

Figure 5-32 Register Device

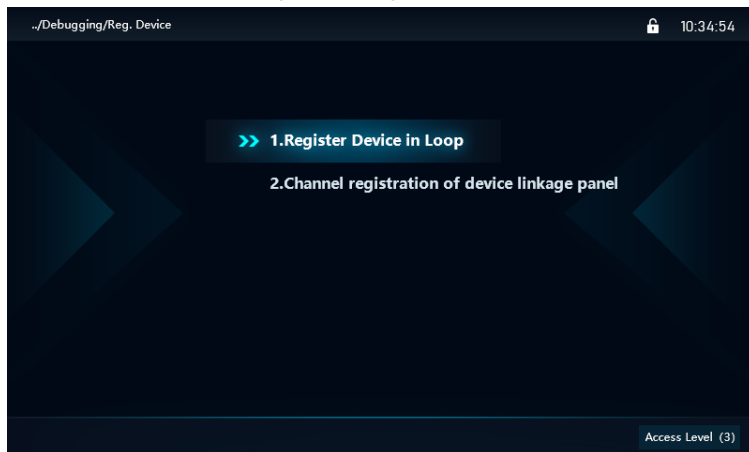

5.6.3.1 Register Device in Loop

Step 1 Select **Debugging > Register Device > Register Device in Loop**.

Step 2 Select register mode, and press **Enter**.

- Select Register Again: Bus device LA remains unchanged.
- Select New Registration: Register based on the internal project information, synchronizing it to the bus device according to the loop and logic address, including device user code, description information, and key parameters. After completing the configuration information of the control panel and supplementing missing equipment in the loop, New Registration can directly deliver and synchronize the information that the panel has to define for the newly added equipment to the newly added equipment. Please refer to Select Register Again.

Step 3 Press **Enter** to keep settings.

5.6.3.2 Channel Registration of Device Linkage Panel

When the device linkage panel channel connection module is increased or reduced, the device linkage panel channel registration needs to be performed, and the information of the device linkage device is registered in the FACP, including the device user code, description information, and key parameters.

5.6.4 Define

Define or modify the user code, description information, key parameters, etc. of the device. It includes four definition functions: local device, manual module panel, device linkage panel, and broadcasting panel.



It can only define registered devices.

Figure 5-33 Define

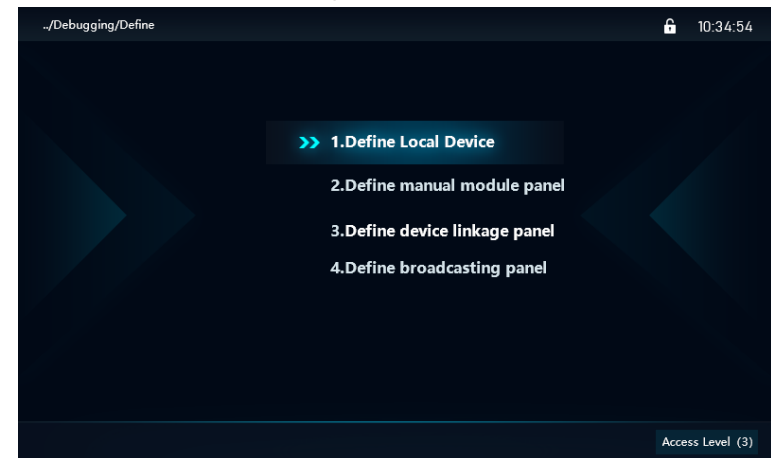

5.6.4.1 Local Device

Define the user code, working parameters and description information of the field device.

Step 1 Select **Debugging > Define > Define Local Device**.

Figure 5-34 Define local device

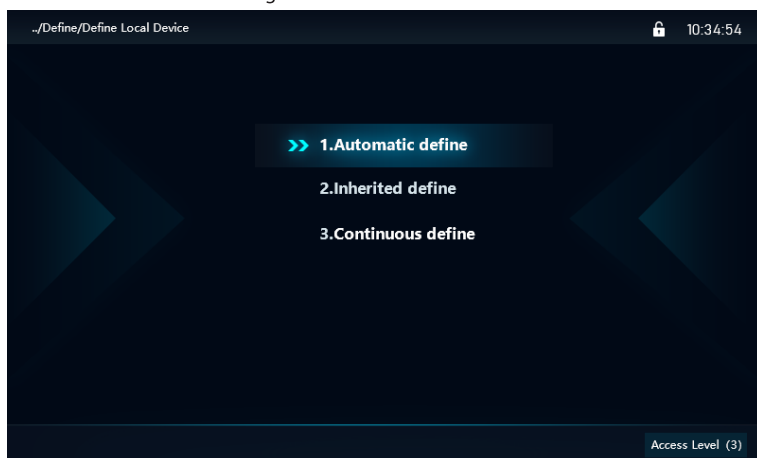
**Step 2** Configure define method.

- Select **Automatic define**, press **Enter**. Automatically define user code, description information and operation parameters for all devices.
- Select **Inherited define**, define the device on the basis of the original definition.
- Select **Continuous define**, the first 5 digits of the user code follow the code of the previous device. The 6th/7th/8th digits of the user code represent the logic address of the device, which is automatically added to the previous one and filled continuously. At the same time, the device type number in the user code remains unchanged.
 1. Configure the device type description to match the device type.
 2. After completing the definition, press the **Esc** to exit, and the interface prompts "Synchronize device definition information?". Press "←" or "→" to select "Yes".
 3. Press **Enter** to save and synchronize device information.



If the device information synchronization operation is not performed, although the panel saves the definition, the device itself keeps the original information unchanged.

5.6.4.2 Manual Module Panel

Set the manual module panel device controlled by each button on the manual module panel, and only bind the device that can execute the startup command.

Step 1 Select **Debugging > Define > Define Manual module panel**.**Step 2** Enter numbers and key code, and press **Enter**.

Enter the user code of the manual module panel device controlled by the button and the action delay at the user number.

- Press **Enter** to save the current setting and go to the next key setting.
- Press **Esc** to exit the definition of the current bus keyboard key.

Figure 5-35 Manual module panel

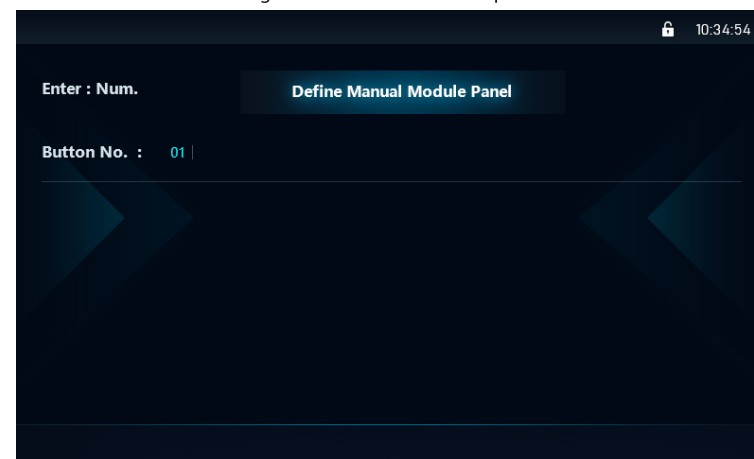
**5.6.4.3 Device Linkage Panel**

The operation of the key definition of the device linkage panel are similar to those of the manual module panel, please refer to 5.6.4.2 Manual Module Panel.



When defining the device linkage panel, make sure that the user number and description information of each key of the device linkage panel are consistent with the actual output wiring of the device linkage panel.

Figure 5-36 Device linkage panel

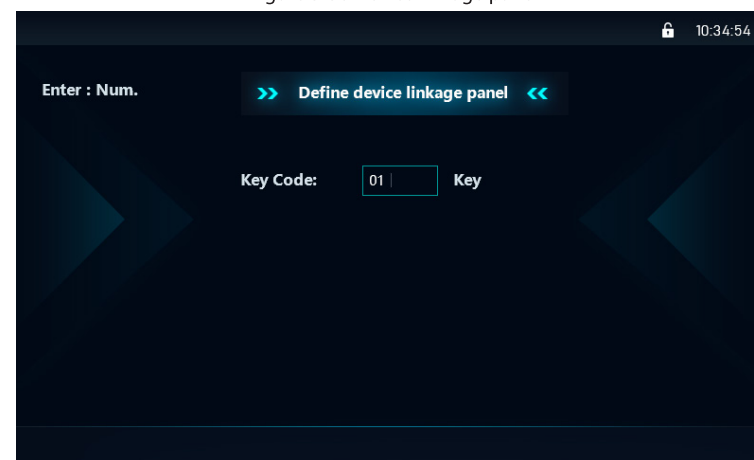

5.6.5 Configuration Synchronize

It includes export / import configuration by U disk, and deliver configuration to device.

Figure 5-37 Synchronize Configuration

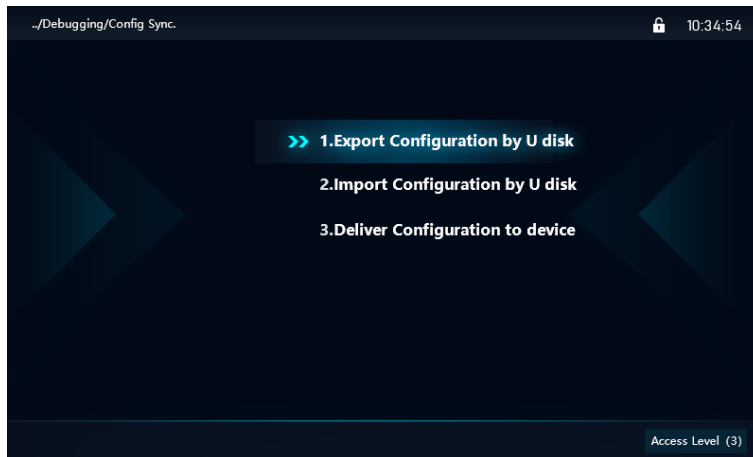

5.6.5.1 Export Configuration by U Disk

Export and save the project configuration file by U disk, which is mainly used to query and check the device information in the debugging software of the host computer, or export the project configuration file for archive backup.

Step 1 Insert the U disk into the USB port behind the control panel.

Step 2 Select **Debugging > Config Sync. > Export Configuration by U Disk**, and press **Enter**.

Save the project configuration file to U disk.

5.6.5.2 Import Configuration by U Disk

In the field application, the configuration information of all field devices can be edited in advance through the host computer debugging software, the configuration file can be put into the U disk, the configuration information can be imported by U disk, and then the configuration information can be sent to the field device to modify device user code, device description information, device parameters and other information. The procedure for importing configuration information from U disk is similar to that of "Exporting configuration by U disk". For details, see 5.6.5.1 Export Configuration by U disk.

5.6.6 Super Tool

It includes Update Firmware, Modify Address, Automatically Assign Address, Silence Mode Switch, Monitor Communication Success Rate, Disable Fire Alarm Siren and Settings of Broadcasting Panel.

Figure 5-38 Super Tool (1)

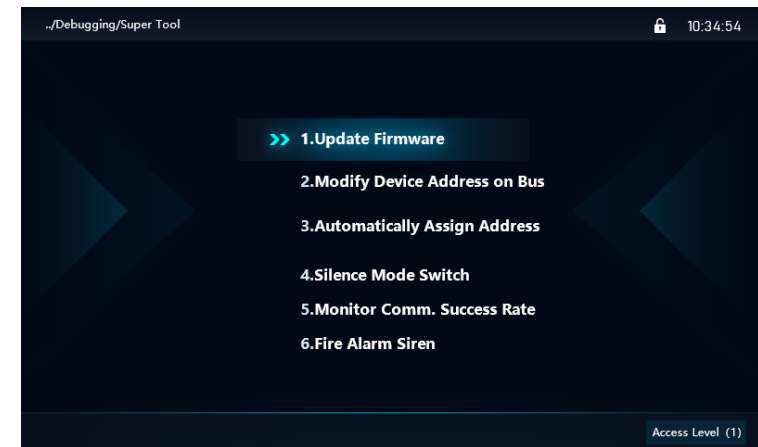
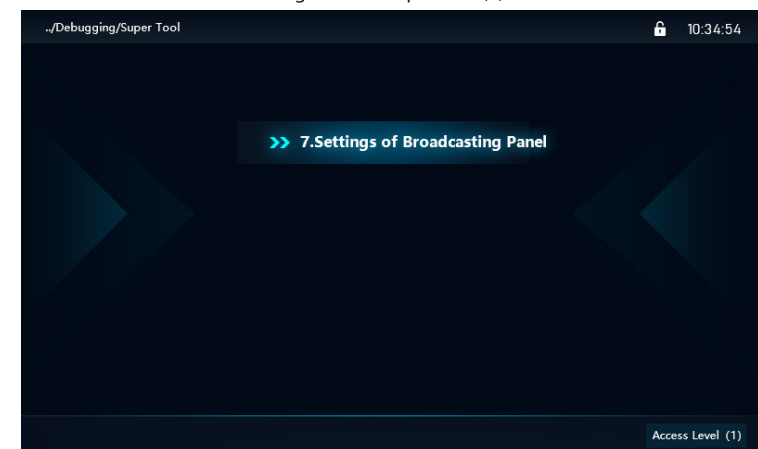

Figure 5-39 Super Tool (2)



5.6.6.1 Update Firmware

Update Firmware is used for upgrading program version by professionals. Insert the U disk containing the update file into the USB port of the manual module panel, and select the upgrade program and press **Enter** to update.

5.6.6.2 Modify Address

Modify Address is used for modifying logic address of bus device.

Step 1 Select **Debugging > Super Tool > Modify Address**.

Step 2 Enter the loop number and logic address of target device, and press **Enter**.

Step 3 Enter the new logic address, and press **Enter** to keep settings.

Step 4 After completing modification, register device and the device has new logic address.



The modification result can be queried in **Device** interface.

5.6.6.3 Automatically Assign Address

When the field bus device does not write the logic address or the logic address of the existing device is repeated, use Automatically Assign Address to register all the bus devices. The system rewrites the logic address of all devices in sequence according to the S/N of each loop bus device.



The Automatically Assign Address will clear the written logic address and re-written new logic address according to device S/N. If all bus devices have written logic address, this function should be disabled to avoid unnecessary rework.

5.6.6.4 Silence Mode Switch

During system debugging, there may be fault or false alarm, triggering audible alarm. Enabling silence mode can temporarily stop the sound of speaker. After completing debugging, please reset silence mode.

5.6.6.5 Monitoring Communication Success Rate

Communication success rate represents the ratio of the successful communications between the device and the control panel to the total communications, determining normal communication. If the communication success rate is above 90%, it means that the communication is normal; otherwise, it is abnormal, and the line needs to be checked.

5.6.6.6 Disable Fire Alarm Siren

Select **Disable Fire Alarm Siren Broadcasting Panel**, disable or enable siren broadcasting by fire alarm.

6 FAQ

Problem	Analysis	Solutions
No display or abnormal display after starting up	<ul style="list-style-type: none"> Abnormal power supply Loose connection with LCD cable 	<ul style="list-style-type: none"> Check 220V AC power supply Check the connection cable
Display Main Power Fault after starting up	<ul style="list-style-type: none"> No 220V AC power supply The fuse of Main power is blown out 	<ul style="list-style-type: none"> Check and connect the cables Replace the AC fuse
Display Battery Fault after starting up	<ul style="list-style-type: none"> Loose connection with battery Battery discharged or damaged 	<ul style="list-style-type: none"> Check the relative parts and ensure the correct connection Power up for more than 24 hours with the AC power supply, if the fault still exists, replace the batteries
No alarm sound	<ul style="list-style-type: none"> Loose connection with Speaker terminals Speaker damaged FACP is in silence mode 	<ul style="list-style-type: none"> Insert the terminal Replace speaker Disable silence mode
Unable to register filed devices	<ul style="list-style-type: none"> Loose connection with filed devices The cable of field devices damaged 	<ul style="list-style-type: none"> Check and connect Check and replace the cable
Printer fails to work	<ul style="list-style-type: none"> Printing type is not set Loose connection with printer No paper in printer or paper is incorrectly put 	<ul style="list-style-type: none"> Set the printing types Check and connect the printer Replace or correctly put printing paper
Registered device is offline	<ul style="list-style-type: none"> Device disconnected Device damaged Loose connection with base 	<ul style="list-style-type: none"> Check the connection Replace the device Re-install the device and make sure the proper installation
LA repeated equipment information	The logic address is repetitive	Find the repetitive device and modify its logic address
Replace device	S/N of devices with the same number in the same circuit is inconsistent due to the replaced device	Replace original device or register

Problem	Analysis	Solutions
Fire/Fault output reports open circuit	Fire/Fault output terminal is not connected with 10K Ω resistor	Check Fire/Fault output terminal
Bus line Fault	Bus line is short circuit	Check the circuit

7 Maintenance

To keep your device in good working condition, please follow these requirements.

- Simulate alarm test: Test the device once half a year (recommended).
- Maintain mini printer: 57 mm \times 35 mm thermal printing paper is adopted. When the printing paper is insufficient, please replace it in time.

Step 1 Press the button on the right side of the printer to open the printer compartment cover.

Step 2 Put in new printing paper, with the thermal side of the printing paper facing up, and place it above the roller to avoid passing under the roller.

Step 3 Close the cover, and slightly expose the paper to the paper output port of the printer.



Do not tilt the printing paper.

Figure 7-1 Printing paper dimension (mm[inch])

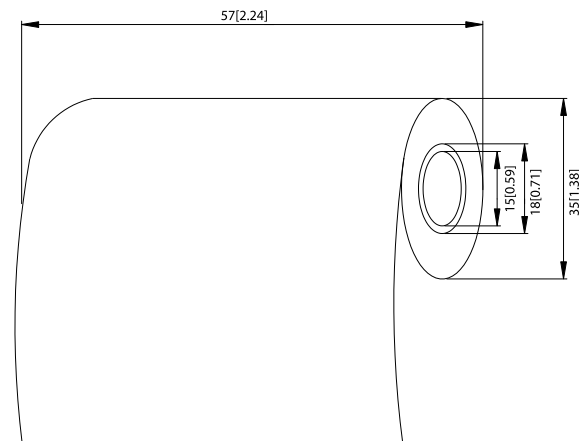

- Battery check: A visual inspection should be made once a quarter and discharging once half a year to ensure they are in good serviceable condition.



The battery has under-voltage protection function. When the battery is under-voltage, the panel will report the under-voltage fault information.

When reporting a backup power failure, check the connector and wiring of the backup battery. When the backup battery continuously works for more than 8 hours, it may also report a backup power failure due to low voltage.

- Fuse maintenance: Check the fuse when the main and backup power supply is abnormal.
If the fuse is burnt out, replace the fuse with same specification.