



Harry Potter



76420





Get excited about our new packaging!

We're switching from plastic to paper-based packaging. That's why you might find a mix of paper and plastic in our boxes!

Nos nouveaux emballages vous emballeront !

Nous passons des emballages en plastique aux emballages à base de papier. C'est pourquoi vous pourriez trouver un mélange de papier et de plastique dans nos boîtes !

¡Te presentamos nuestros nuevos empaques!

Estamos sustituyendo las bolsas de plástico por bolsas con base de papel. ¡Por eso, puedes encontrar una mezcla de papel y de plástico en nuestras cajas!

[LEGO.com/sustainable-packaging](https://www.lego.com/sustainable-packaging)



BUILDER



Apple and the Apple logo are trademarks of Apple Inc., registered in the U.S. and other countries and regions. App Store is a service mark of Apple Inc. Google Play and the Google Play logo are trademarks of Google LLC. Tencent and the Tencent logo are trademarks of Tencent Inc.

Q [LEGO.com/devicecheck](https://www.lego.com/devicecheck)

EN Ask parents' permission before going online | DE Eltern um Erlaubnis bitten, bevor du online gehst | FR Demande l'autorisation d'un parent avant d'aller en ligne | IT Chiedi il permesso ai tuoi genitori prima di andare online | ES Pídeles permiso a tus papás antes de conectarte a Internet | PT Peça autorização aos pais antes de acederes online | JA オンラインになる前に ほかの方のきよかももらおう | ZH 上网前应先征得父母的同意 | KO 온라인 접속 전에 보호자 동의가 필요합니다 | RU Спроси разрешения у родителей, прежде чем заходить в интернет | PL Poproś rodziców o zgodę, zanim wejdiesz do Internetu | CS Než půjdeš na internet, požádej rodiče o svolení | SK Skôr než pôjdeš na internet, vypýtaj si povolenie od rodičov | HU Kérj szülői engedélyt, mielőtt online csatlakoznál! | RO Cere permisiunea părinților înainte de a te conecta online | BG Поискайте разрешение от родител, преди да влезете онлайн | LV Pirms došanās tiešsaistē palūdz atļauju vecākiem | ET Enne Interneti kasutamist küsi vanematelt luba | LT Prieš prisijungdami prie interneto, atsiklauskite tėvų

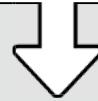
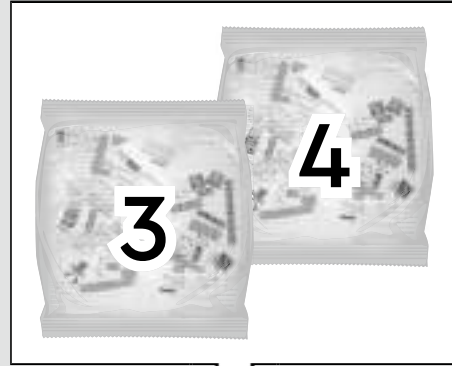
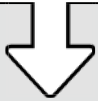

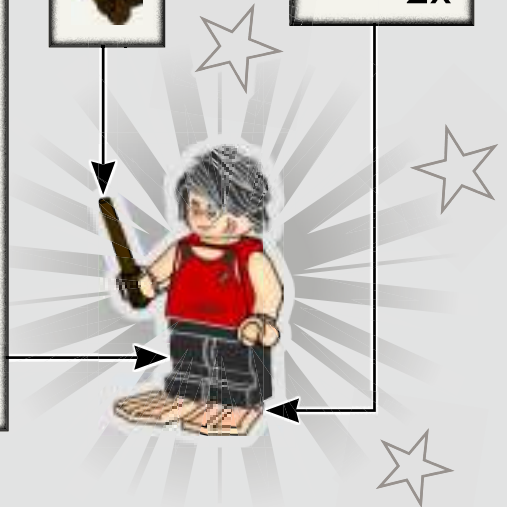
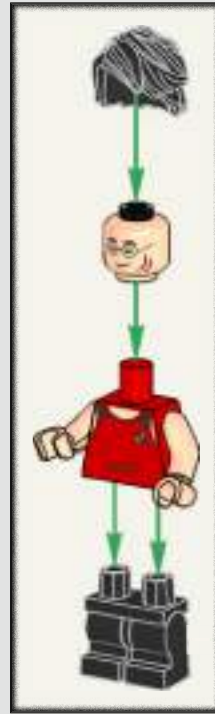

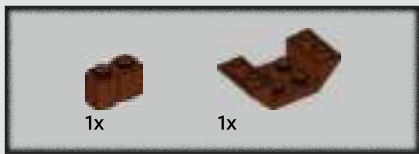

1

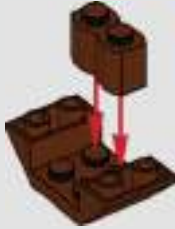

2



3



4



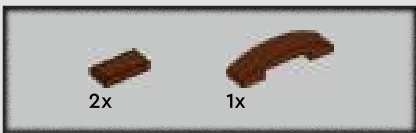

5

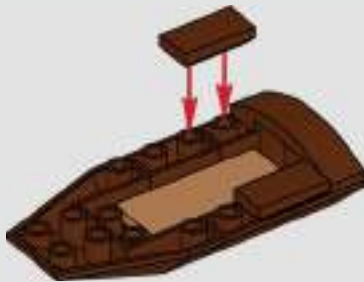

6

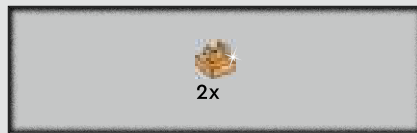

7



8



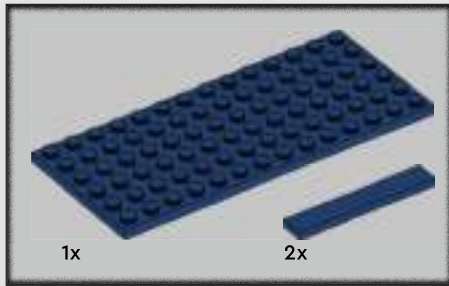

1

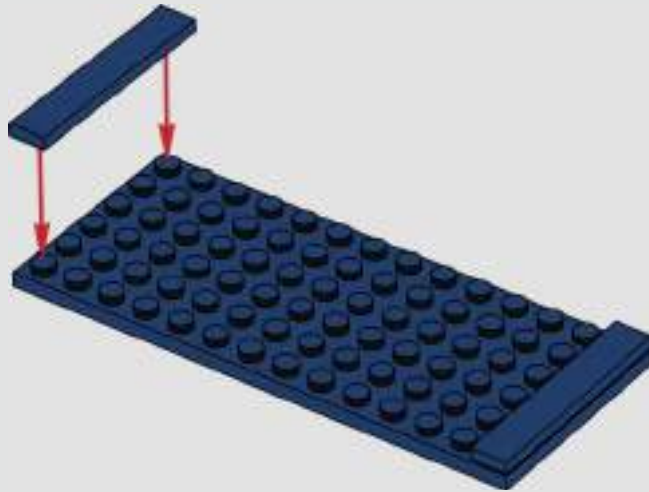



2

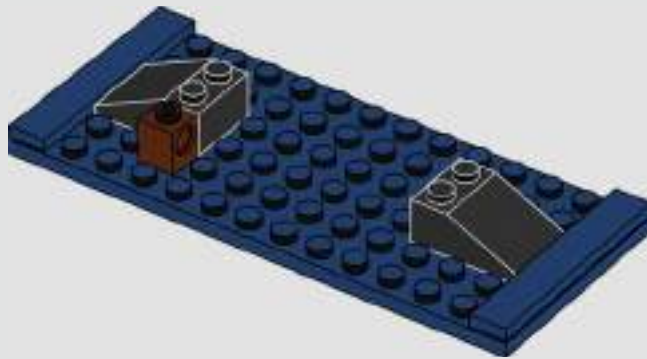



3

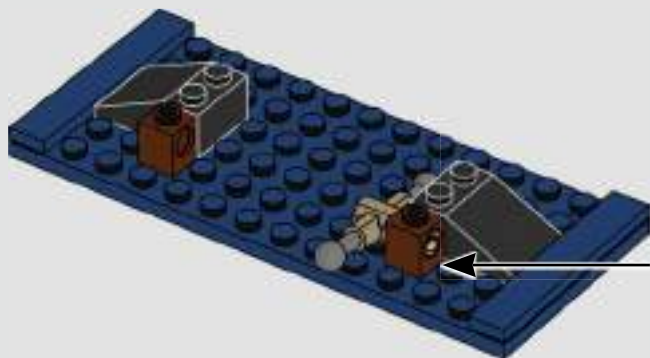
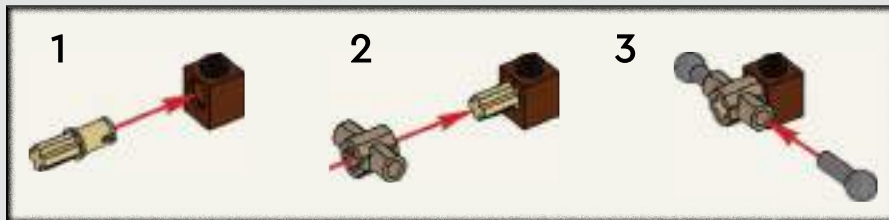

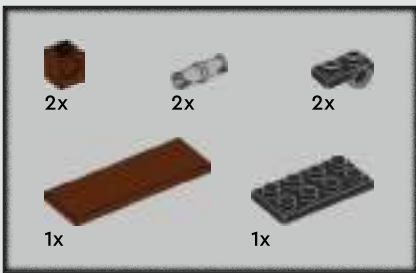

4

1



2



3



4

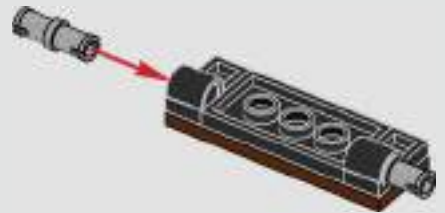

5

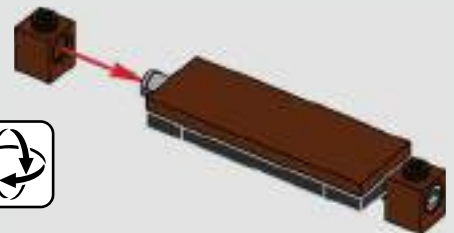

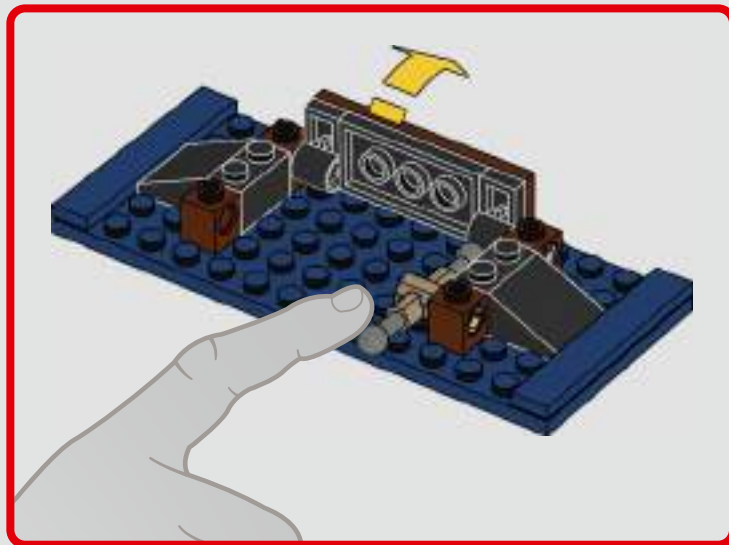
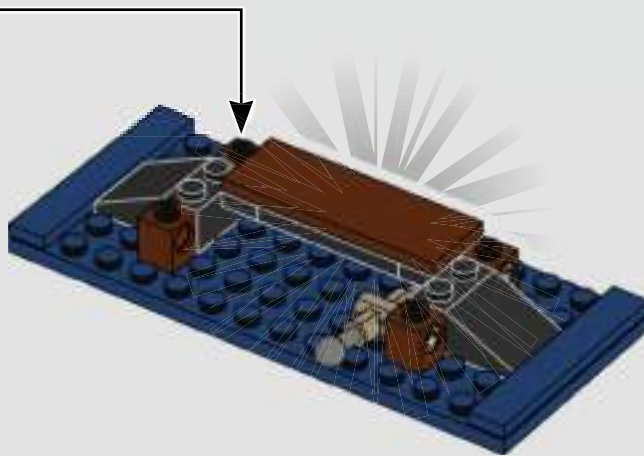



5

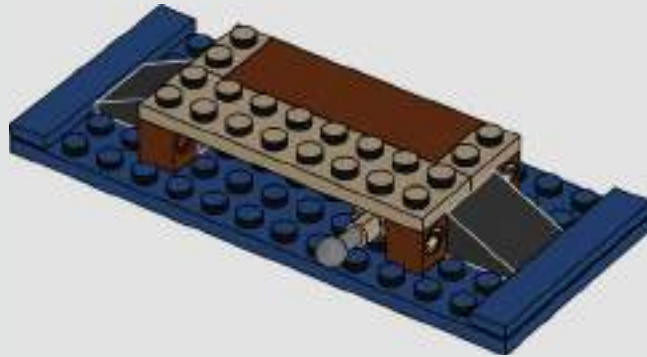

6

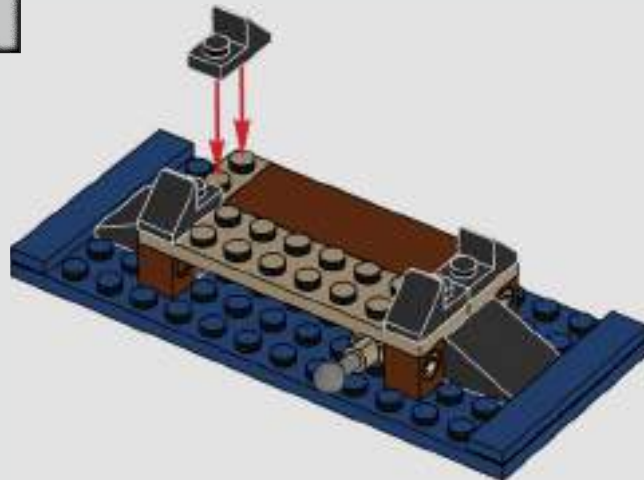

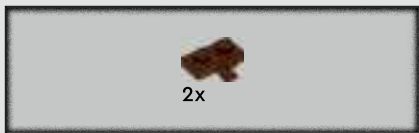

7

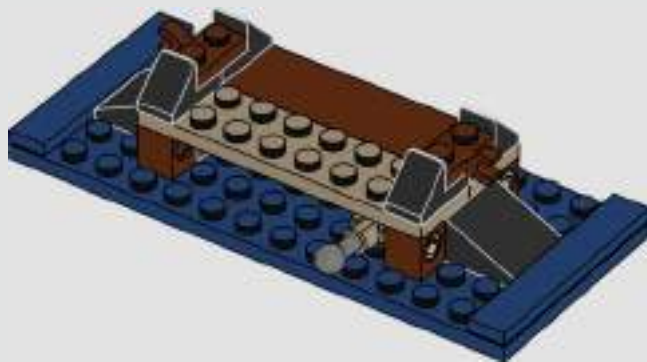



8

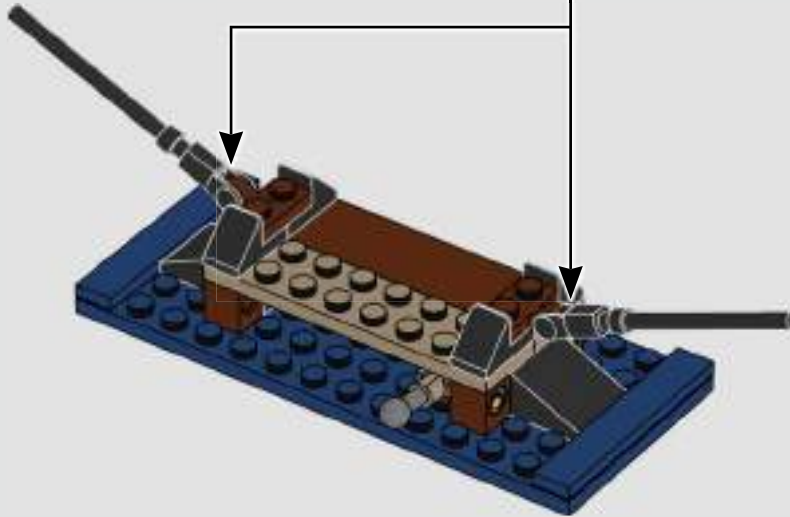

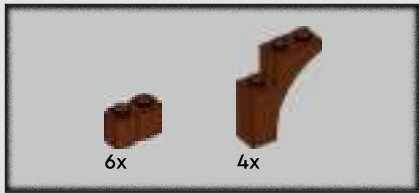

9

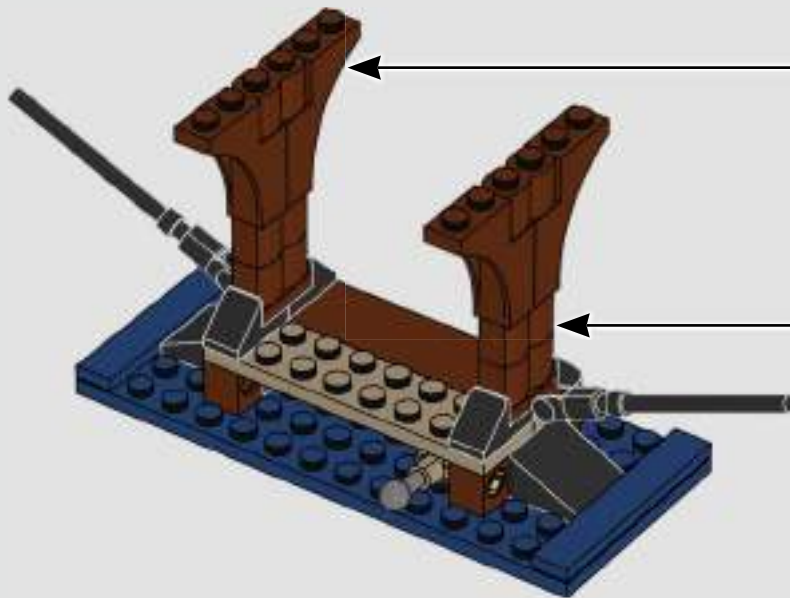
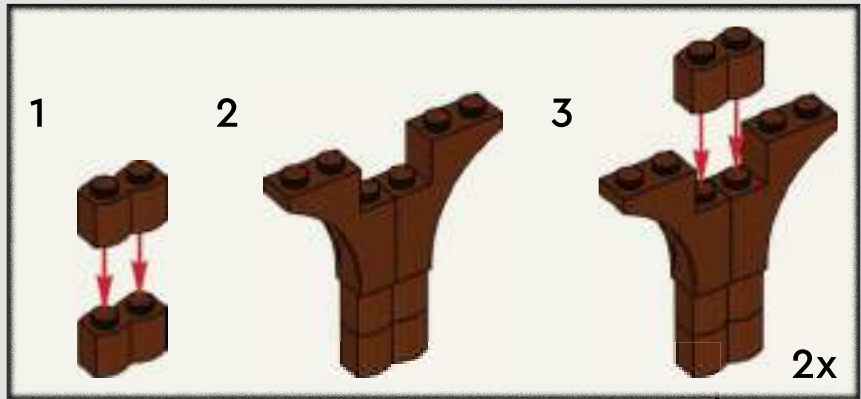

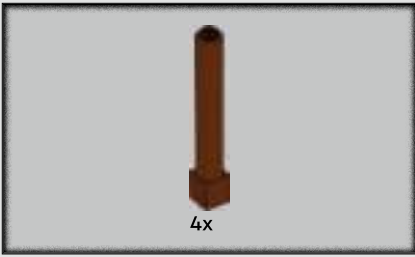

10

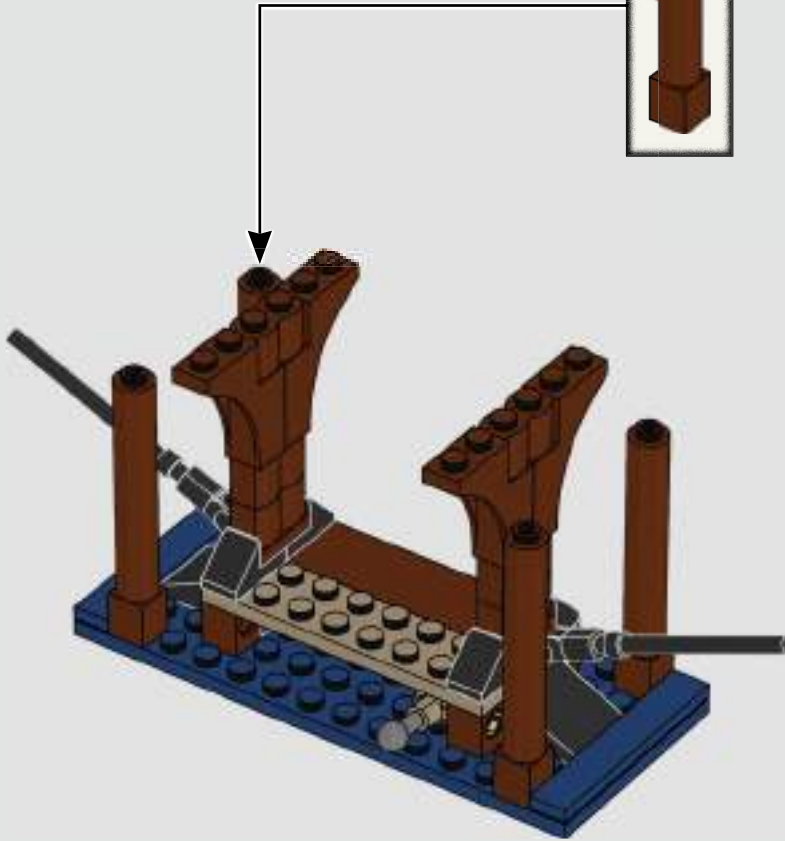



11

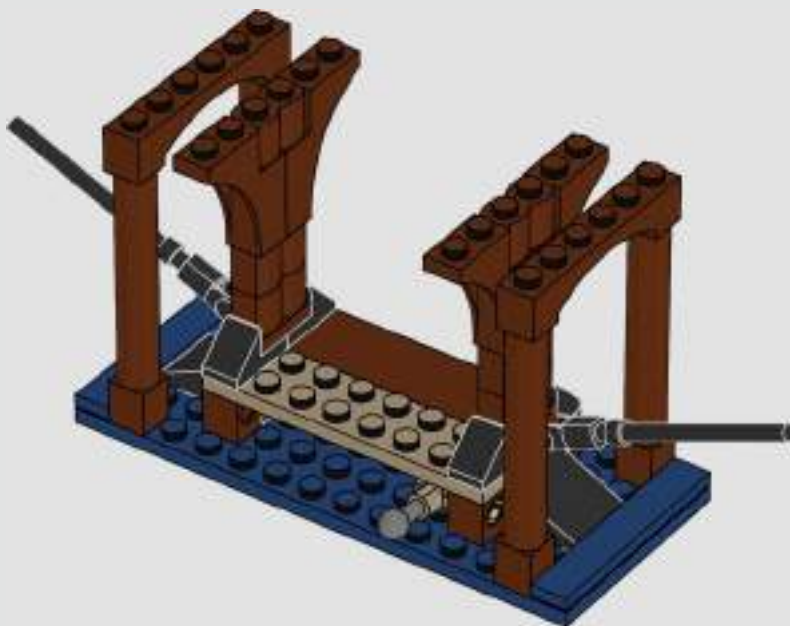



12

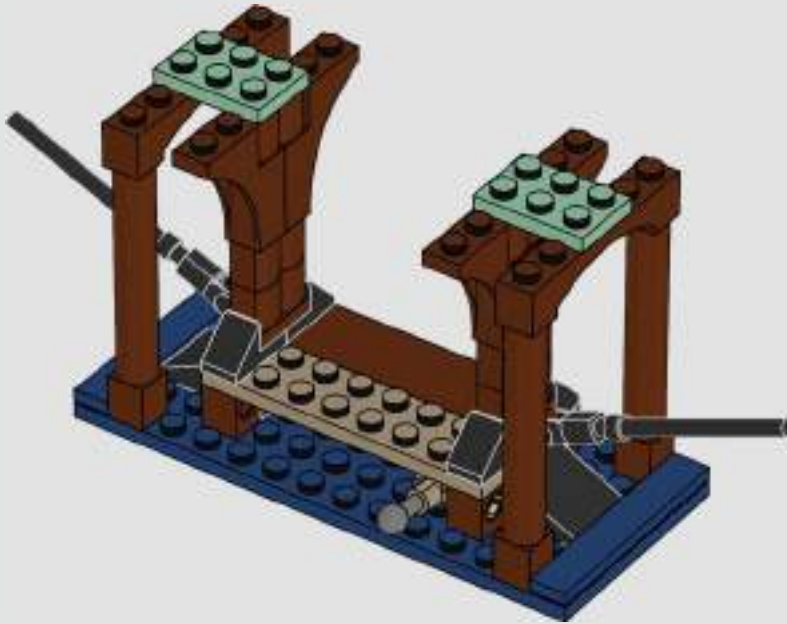

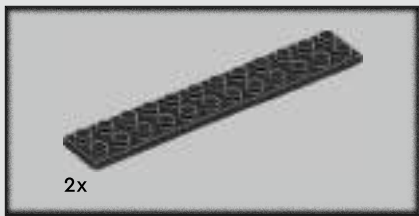

13

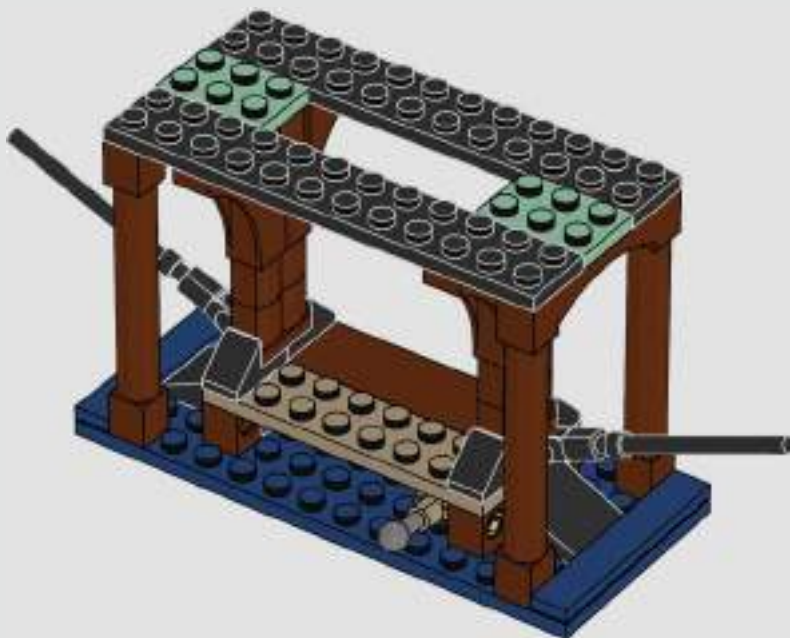



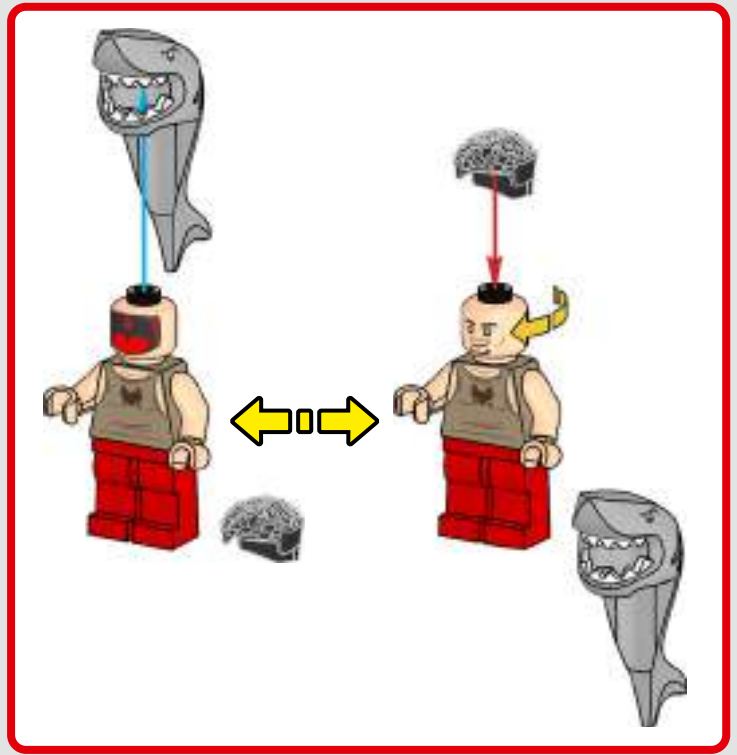

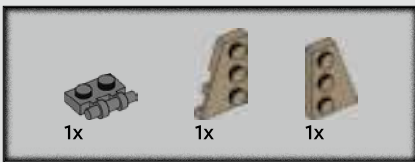

14

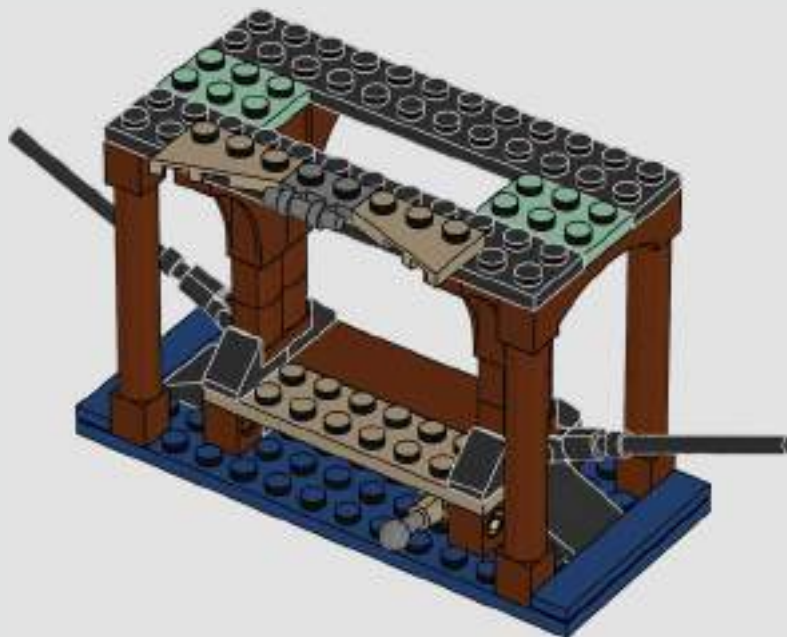



15

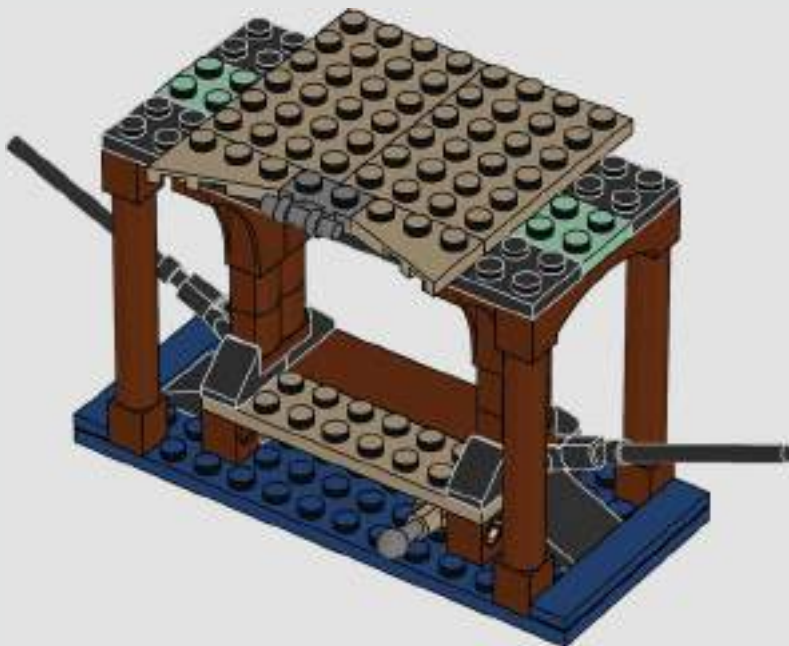



16

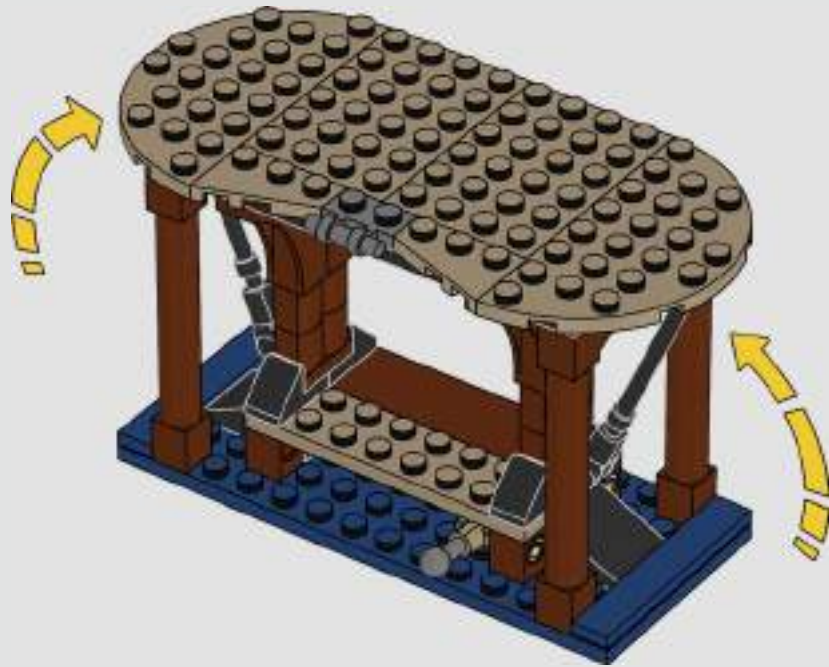

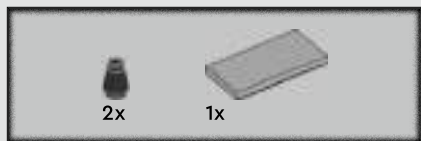

17

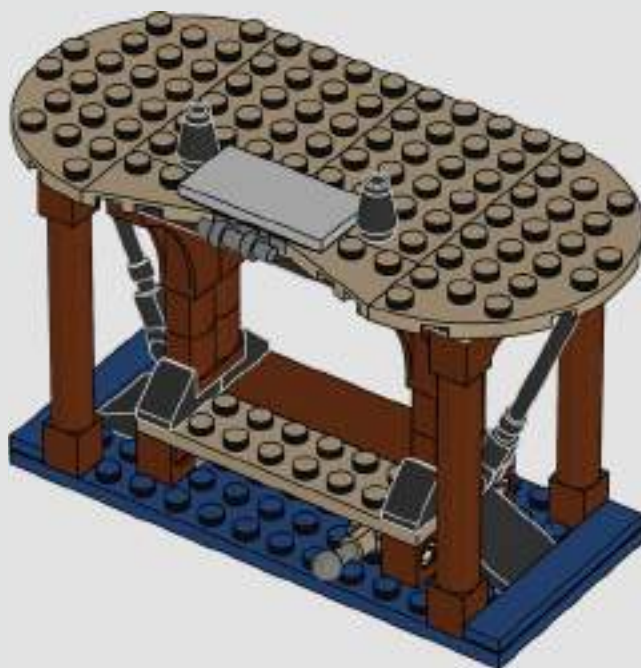

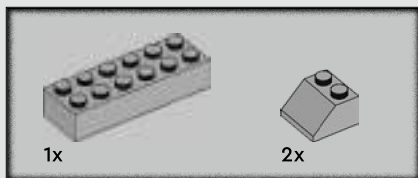

18

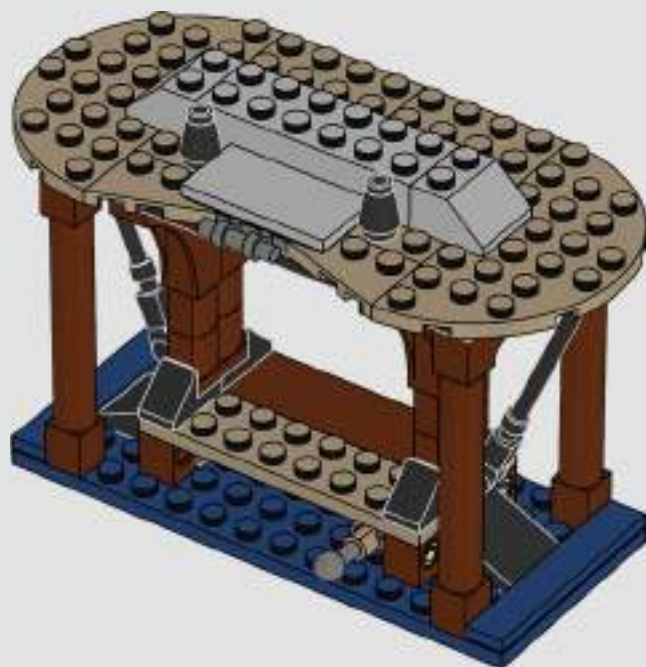

19

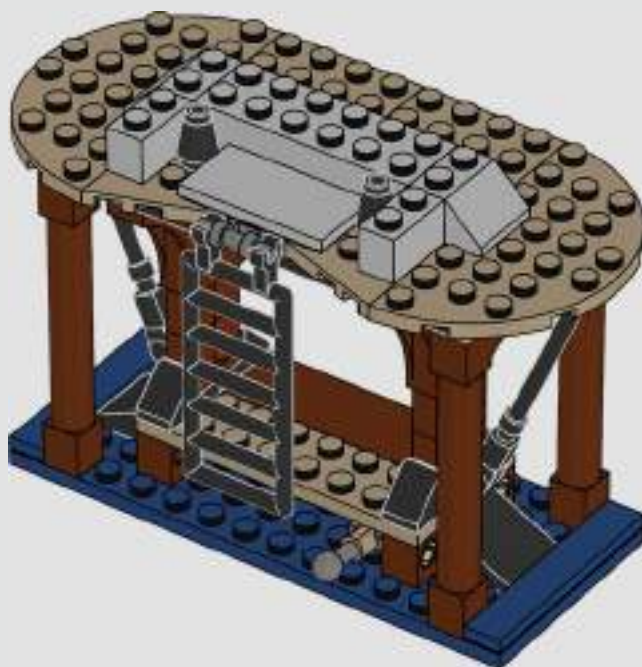



20

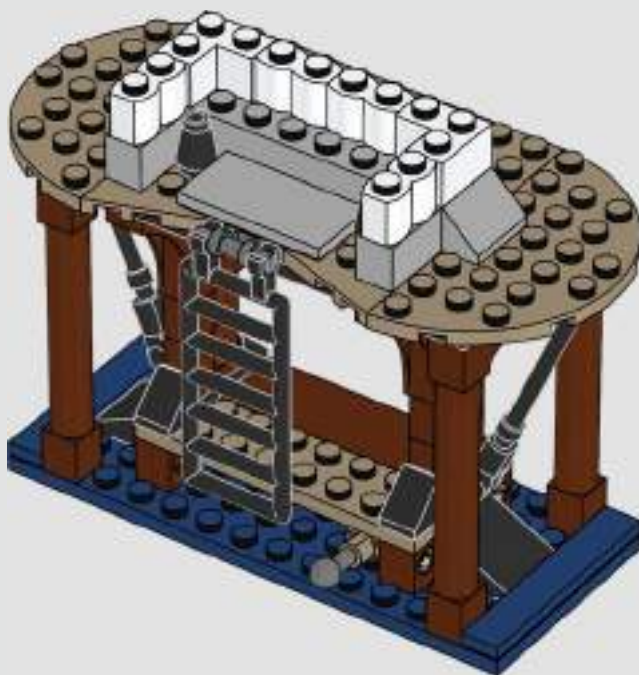



21

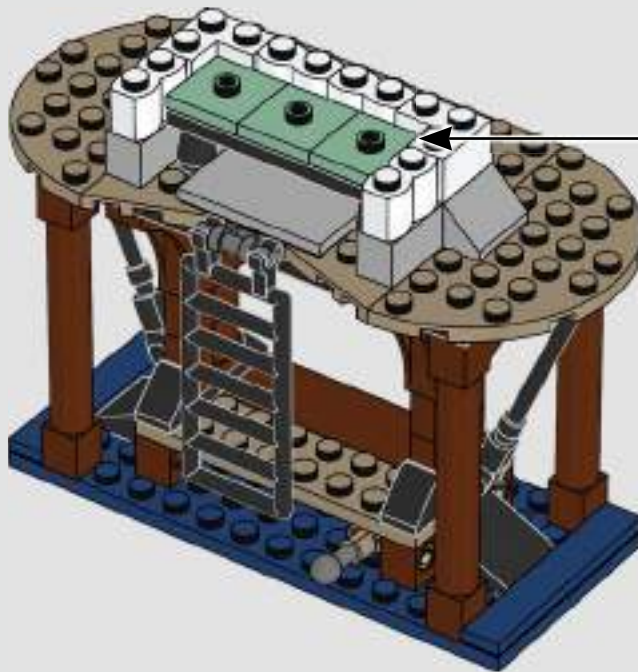
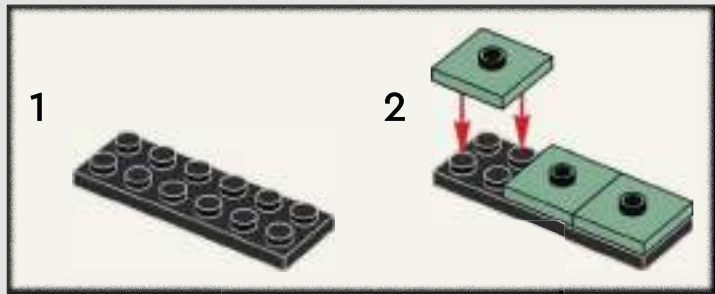

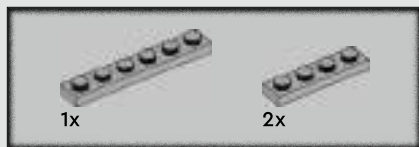

22

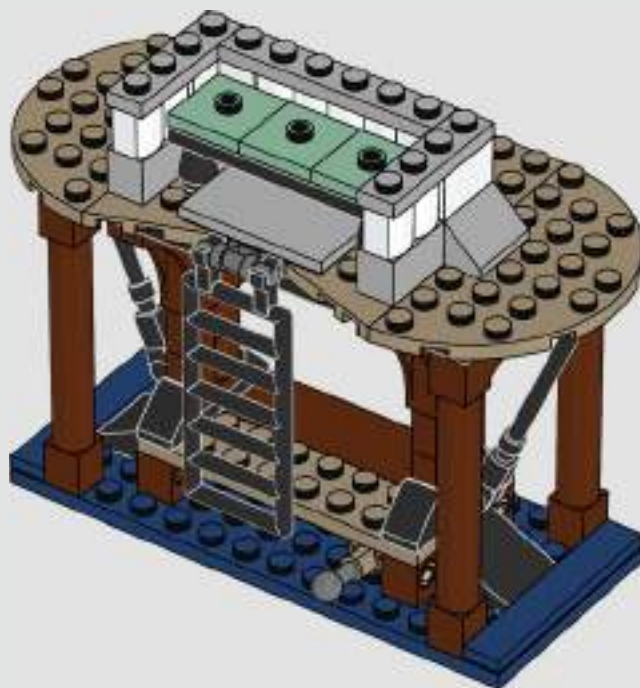



23

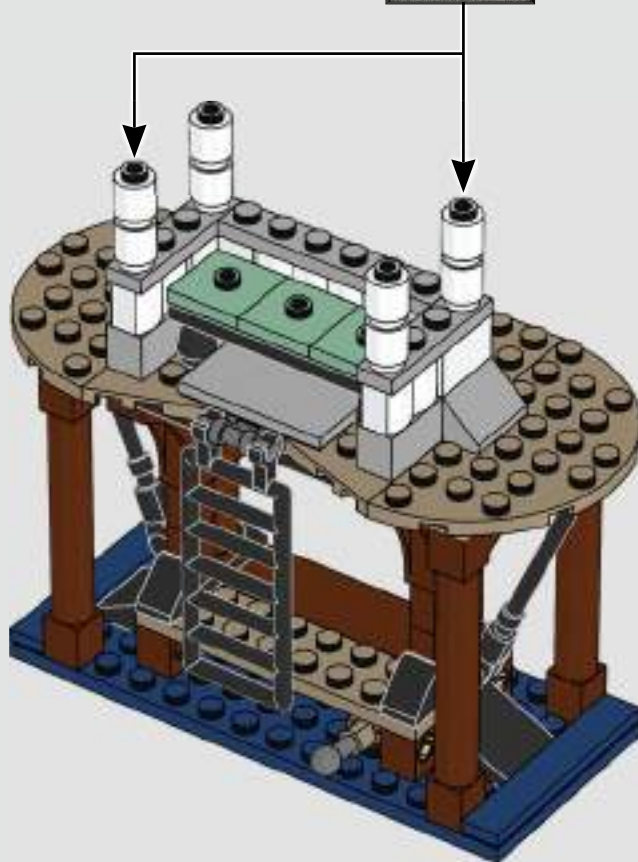
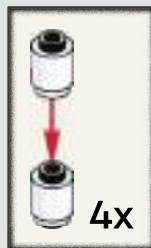

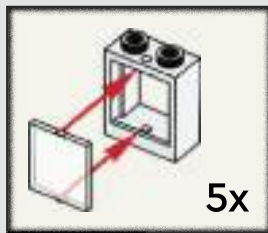
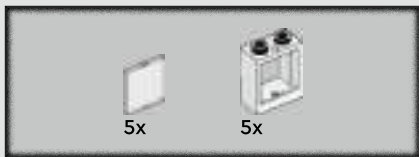

24

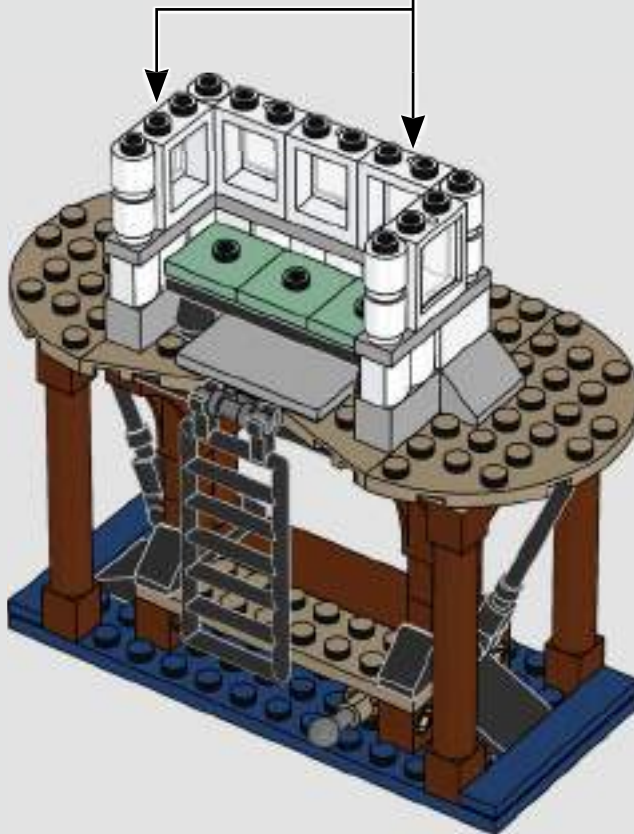

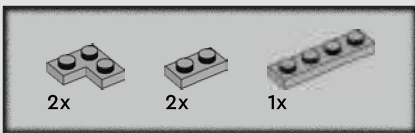

25

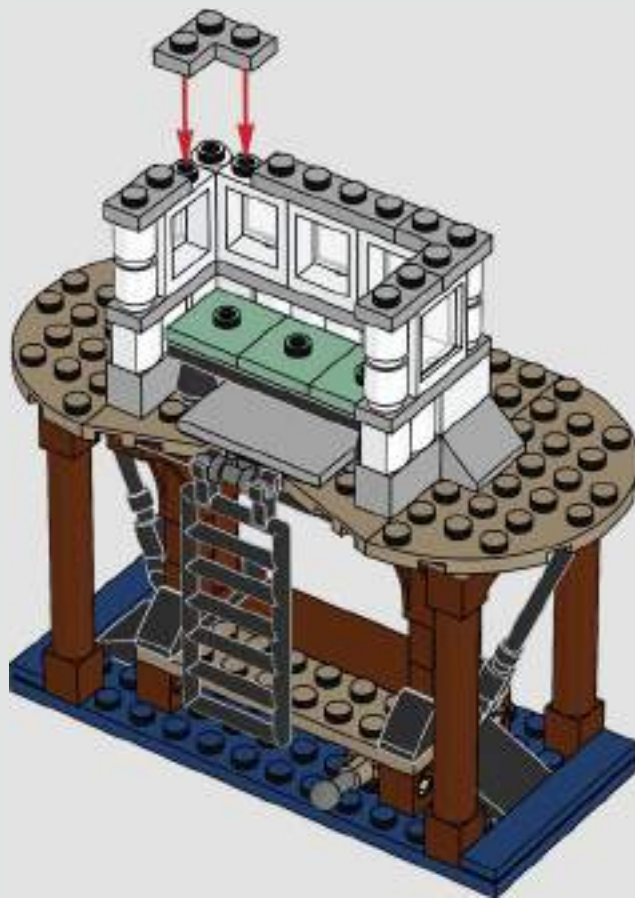



26

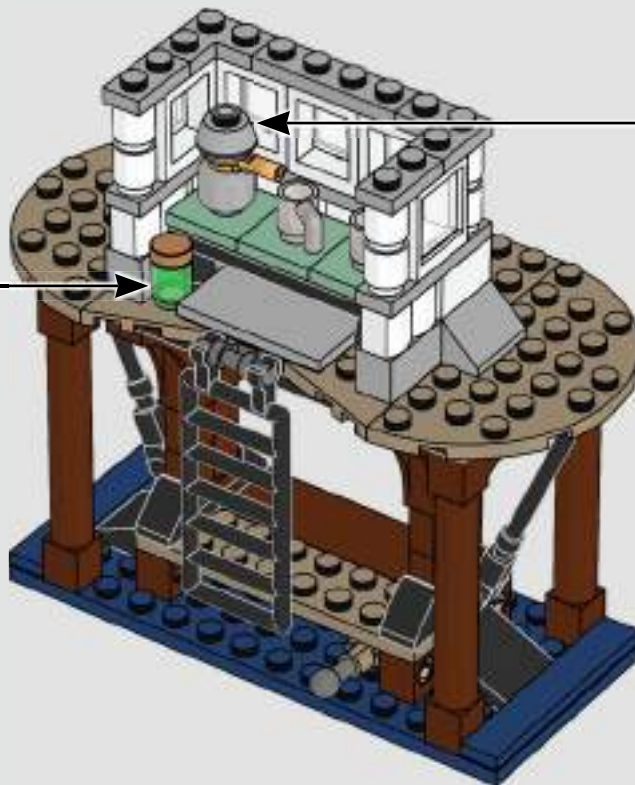

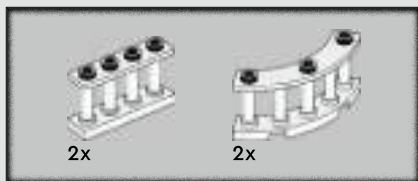

27

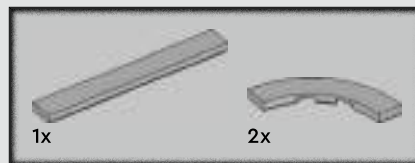
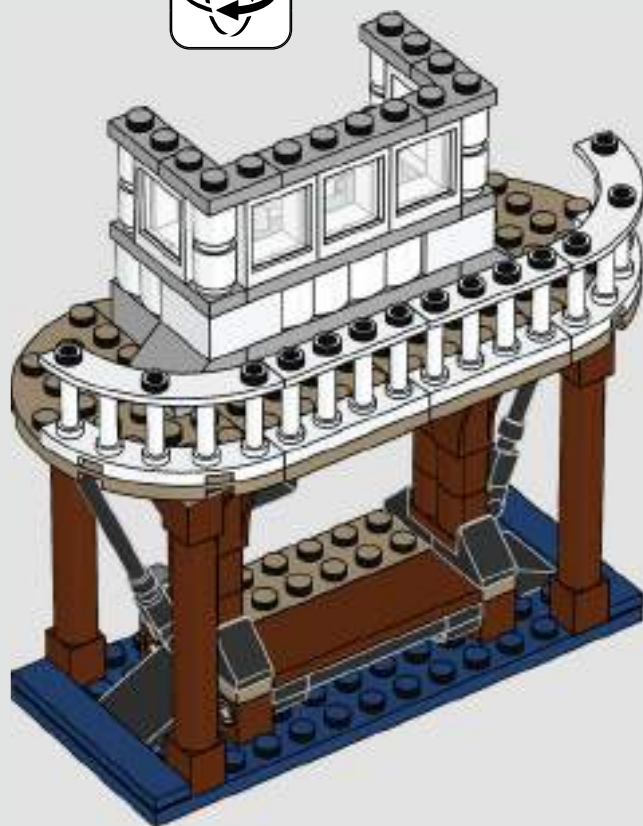

28

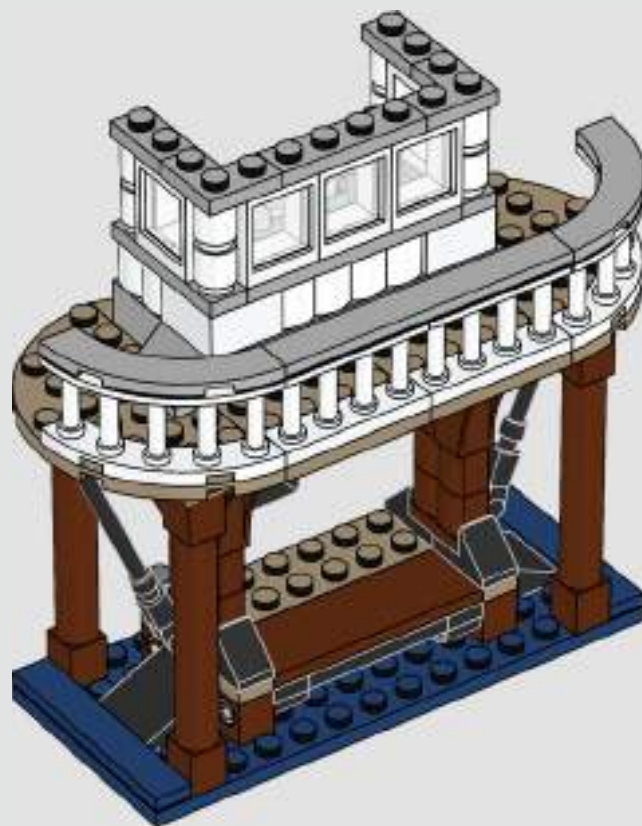

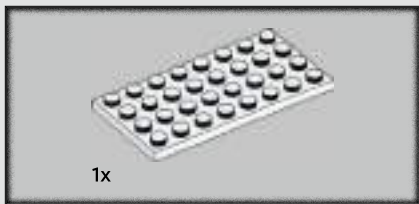

29

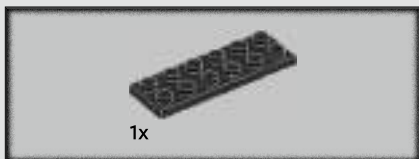
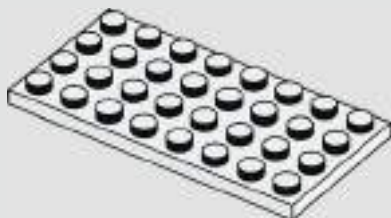

30

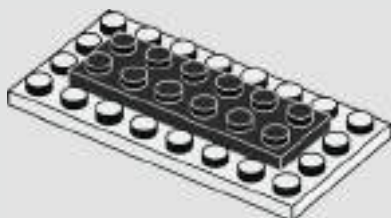

31

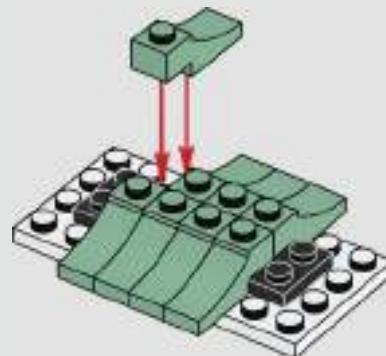

32

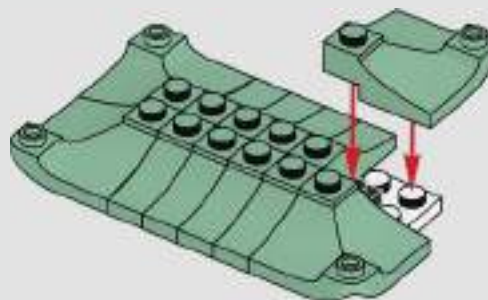



33

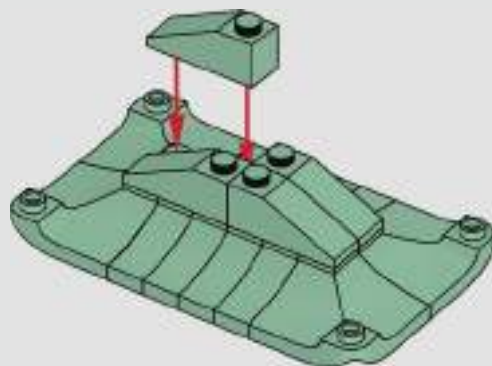

34

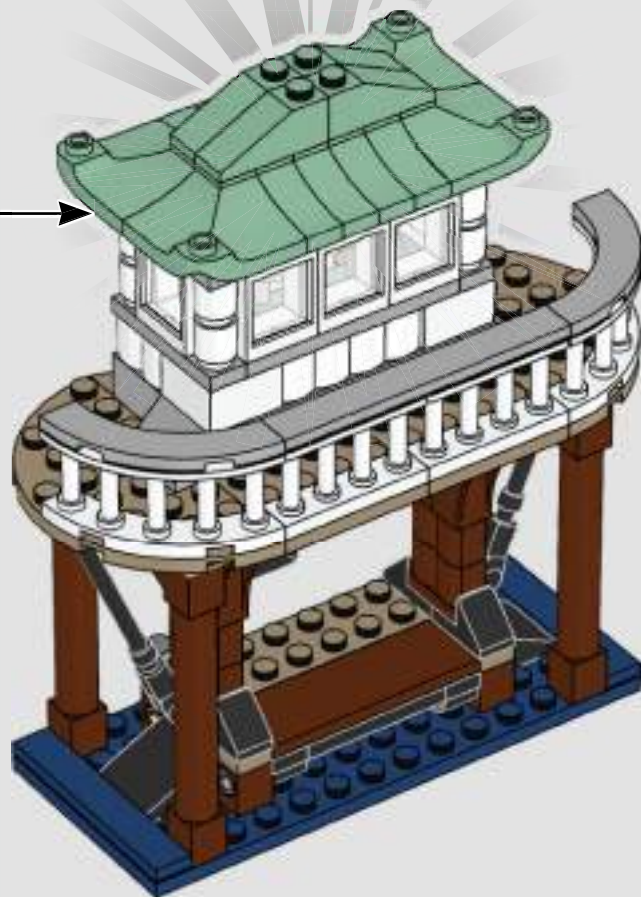



35

1

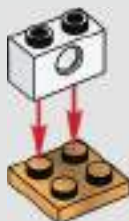

2



3



4

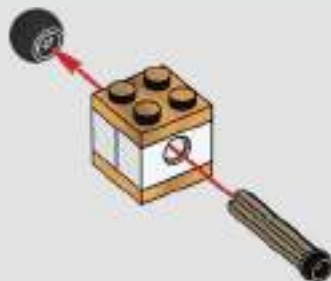

5



6



7

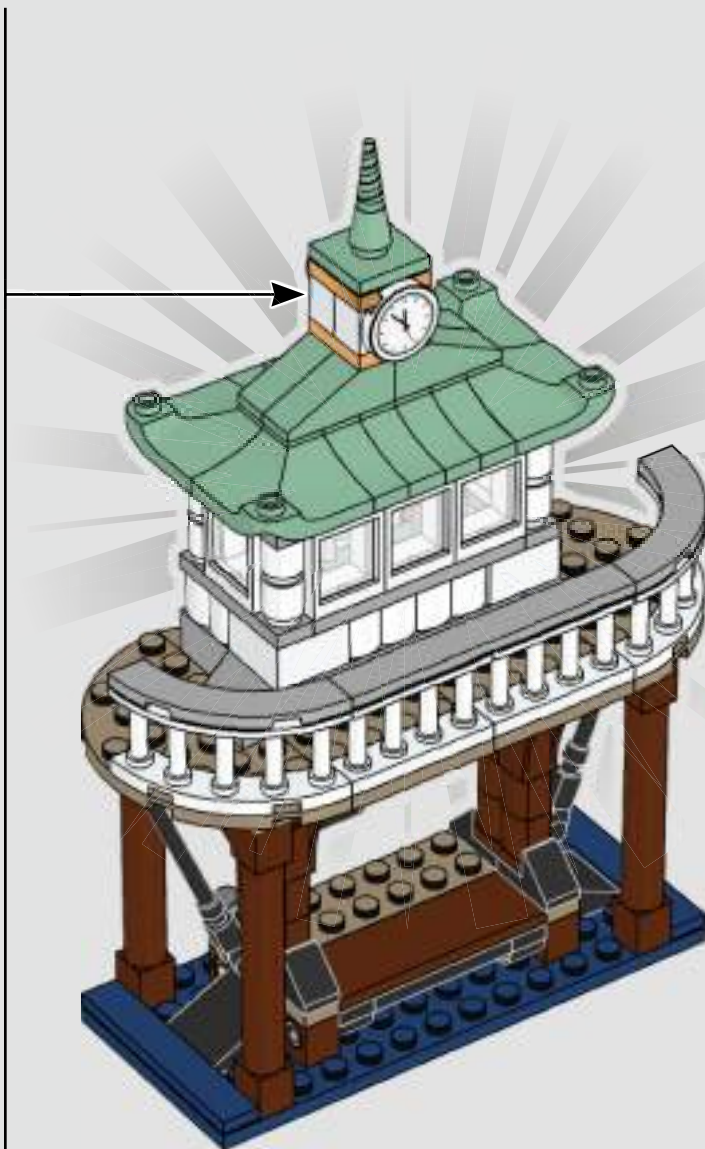

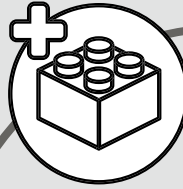
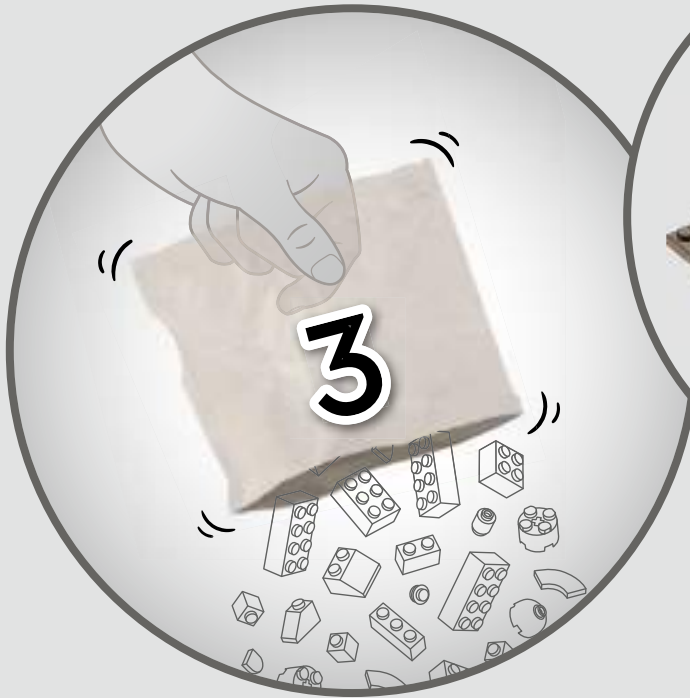

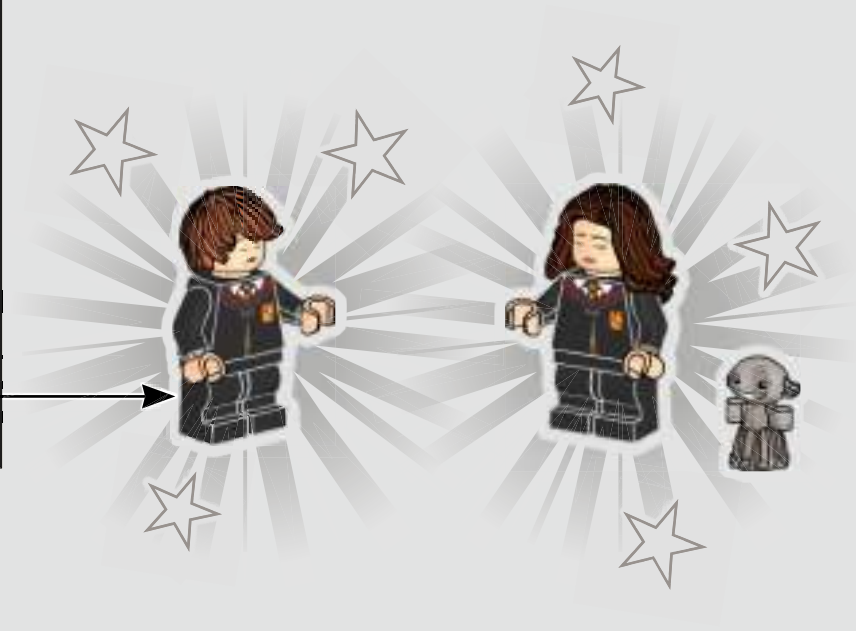
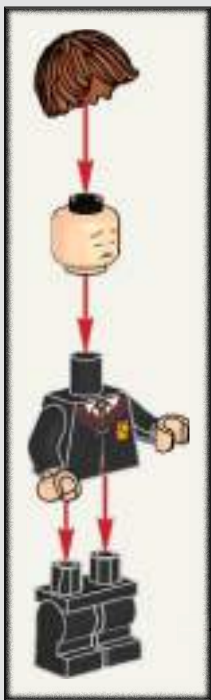

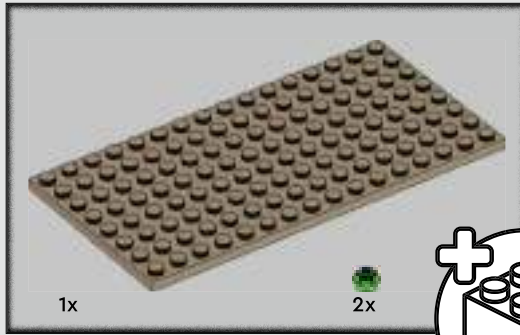

1x

2x

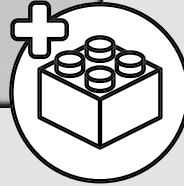

36

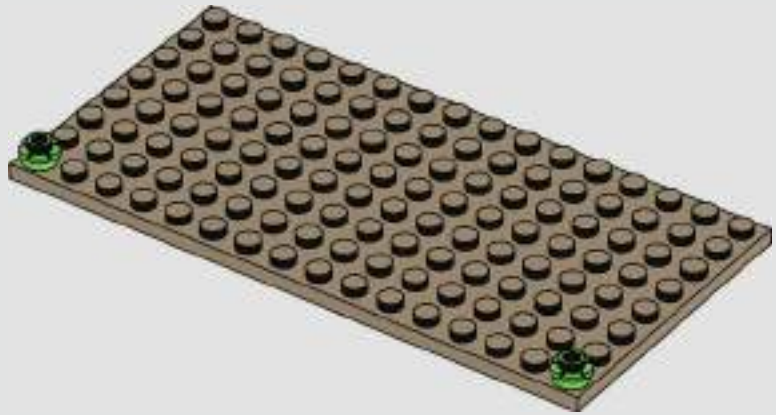



37

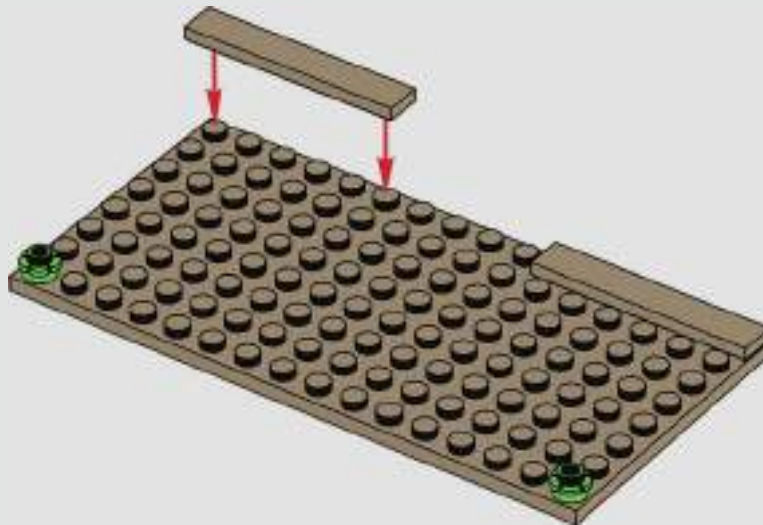



38

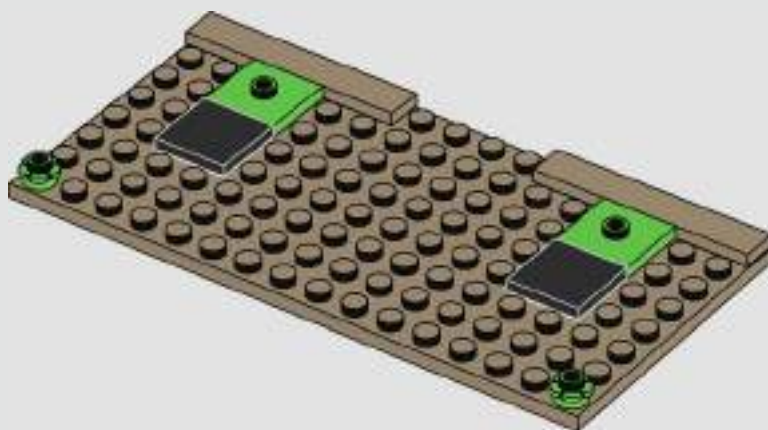

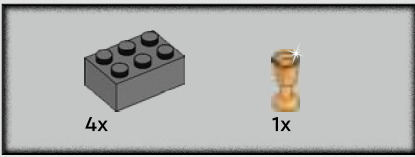

39





40

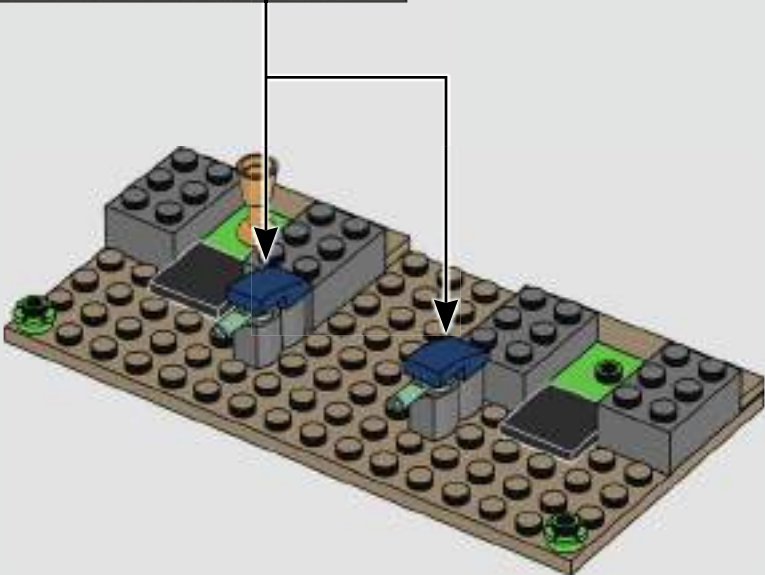
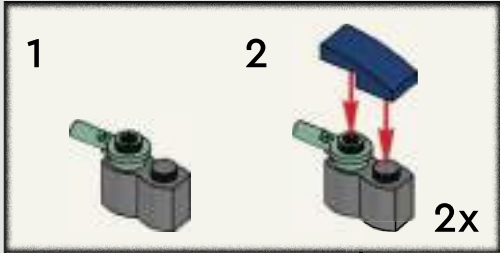



41

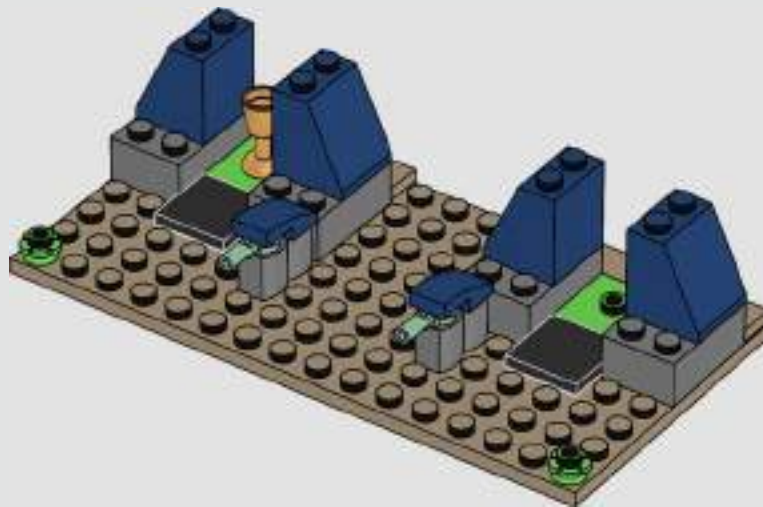



42

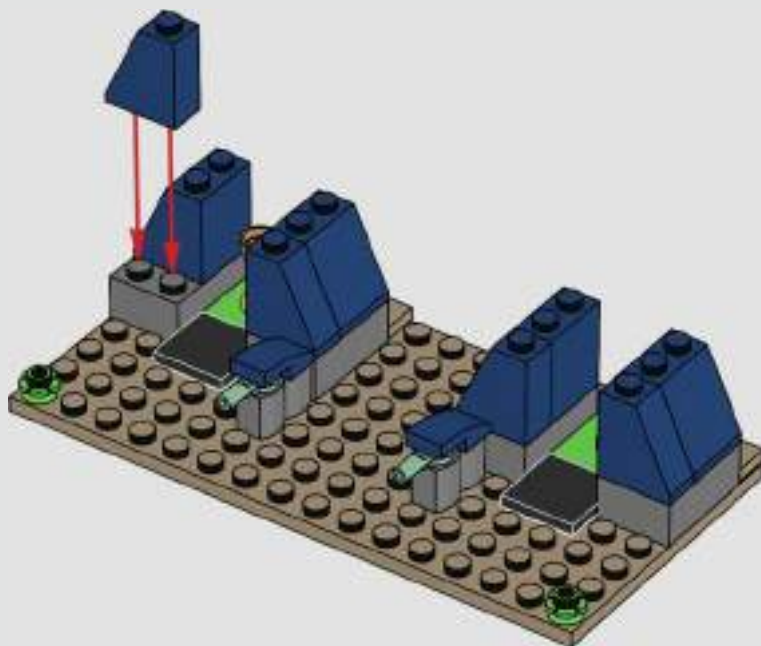

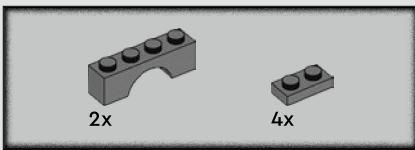

43

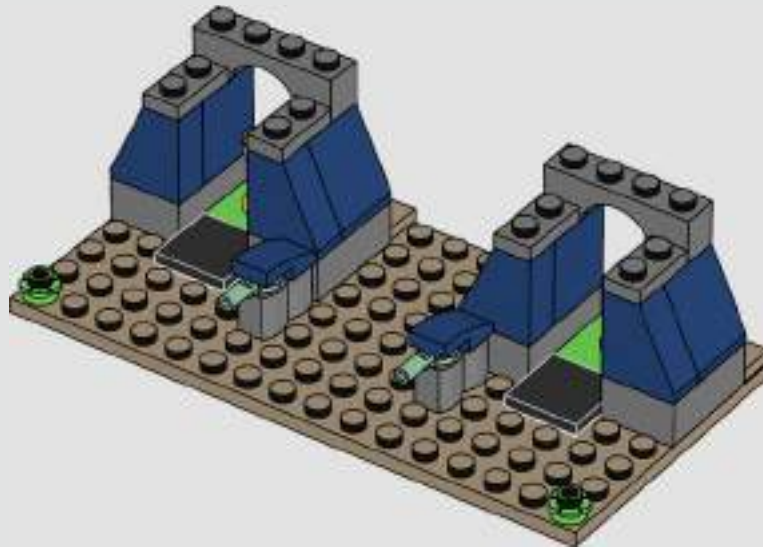



44

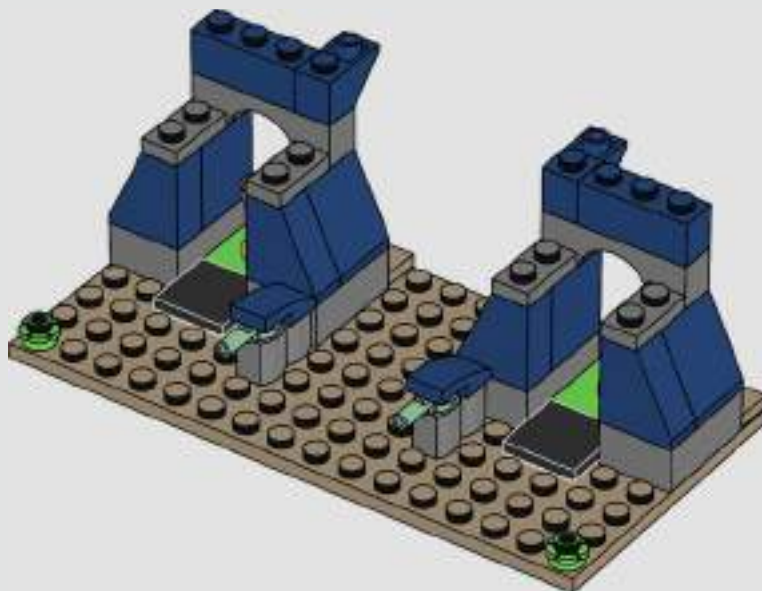

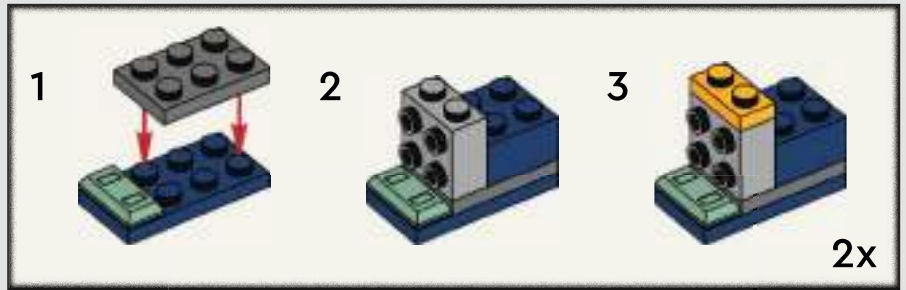
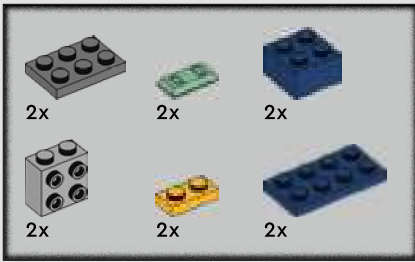

45

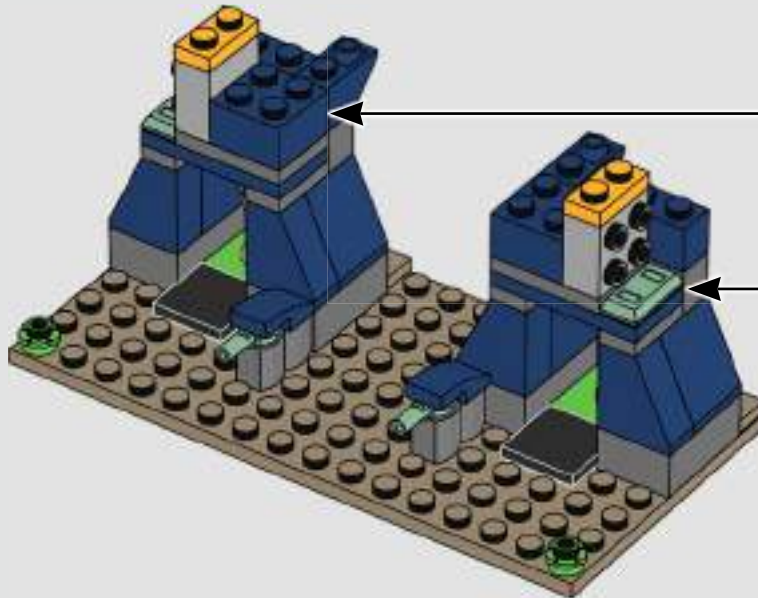

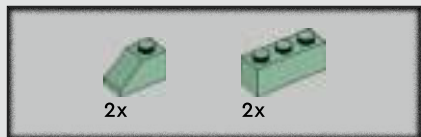

46

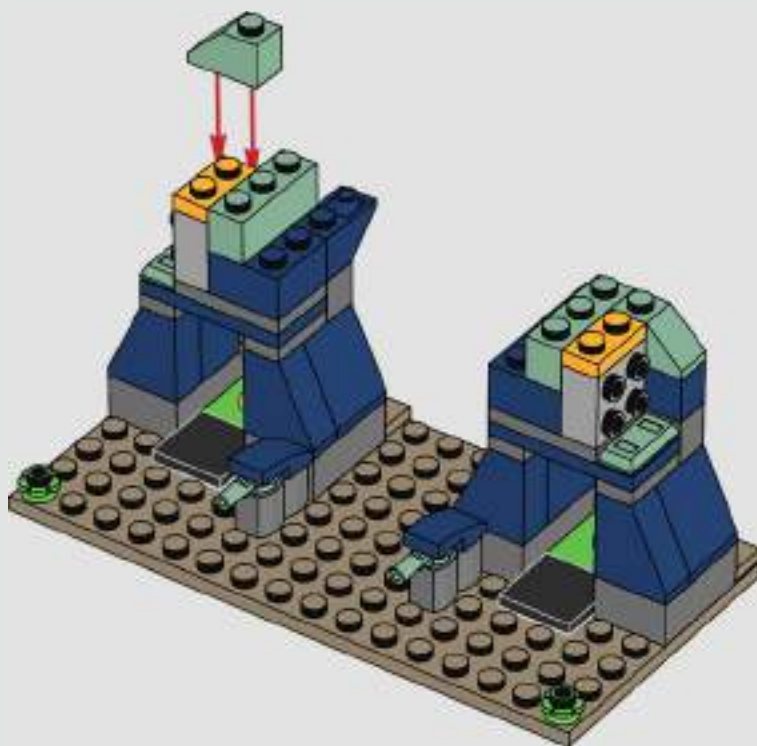

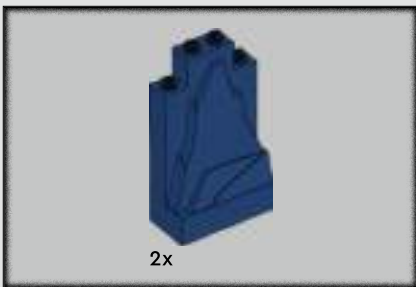

47

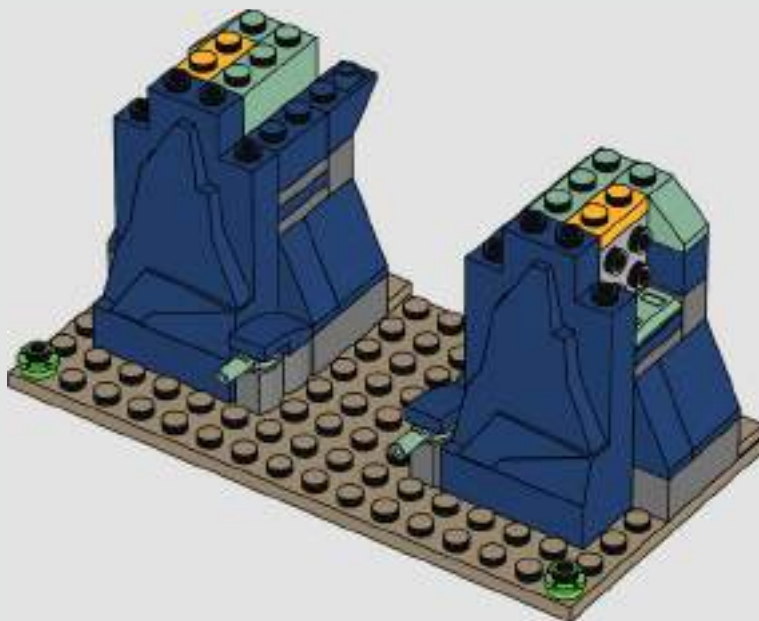

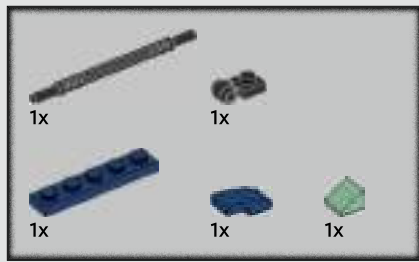

48

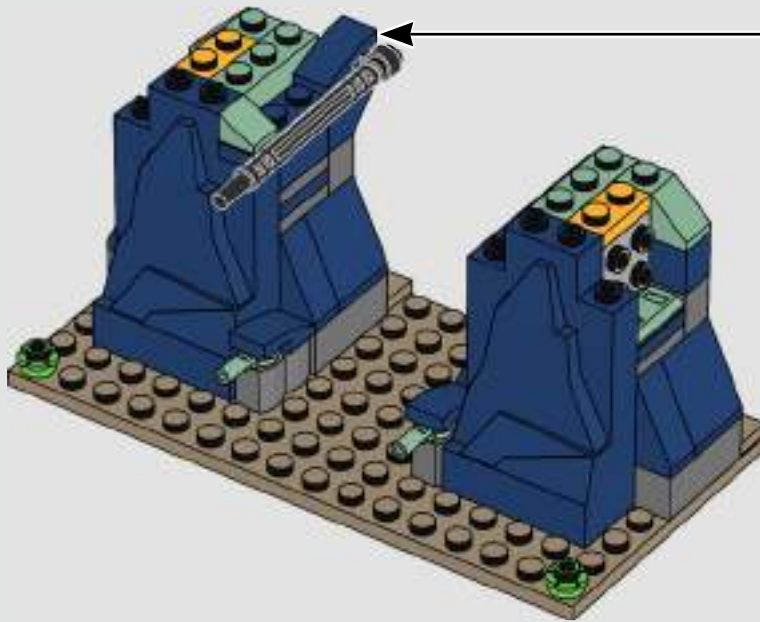
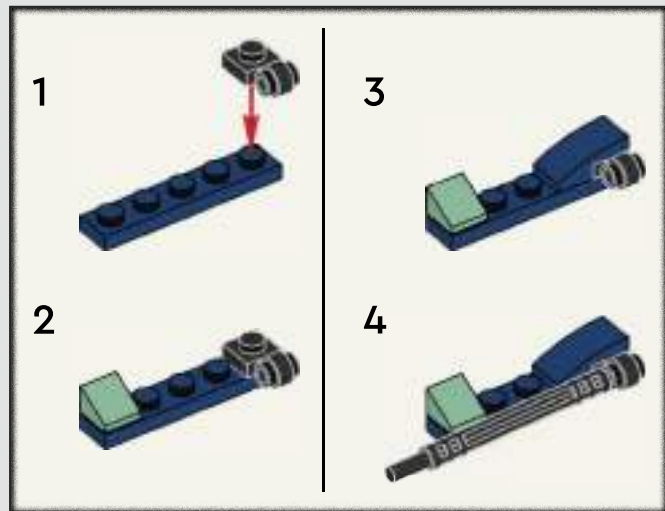

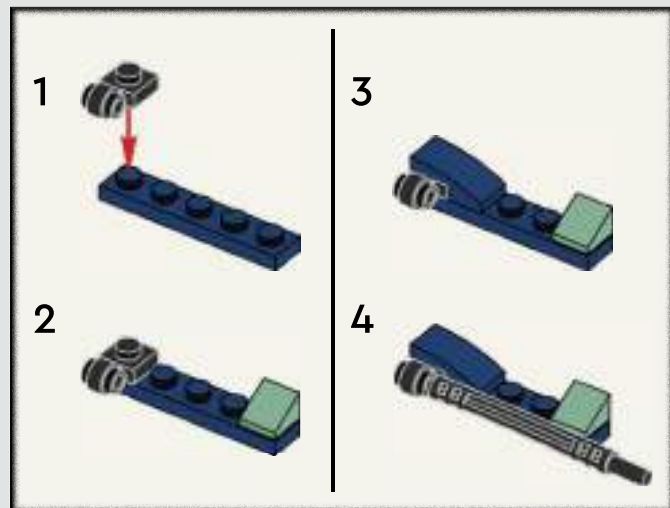

49

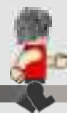
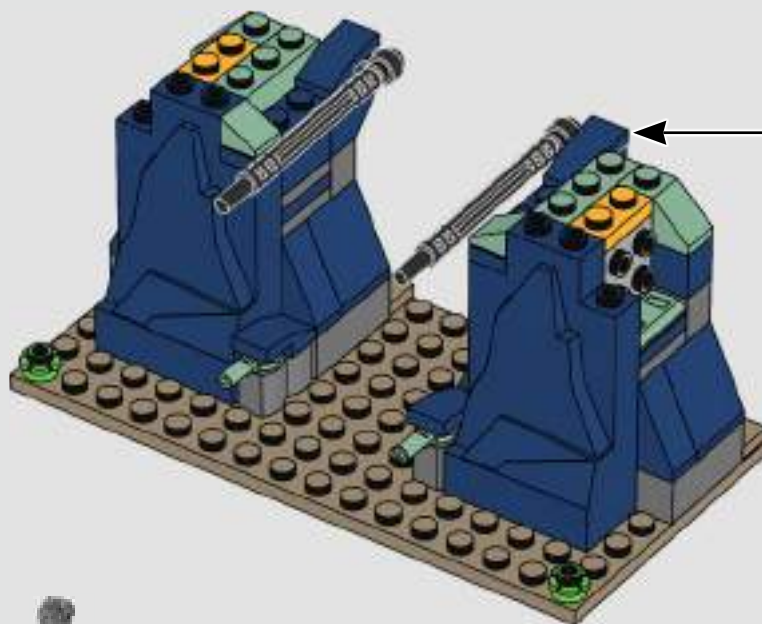



50

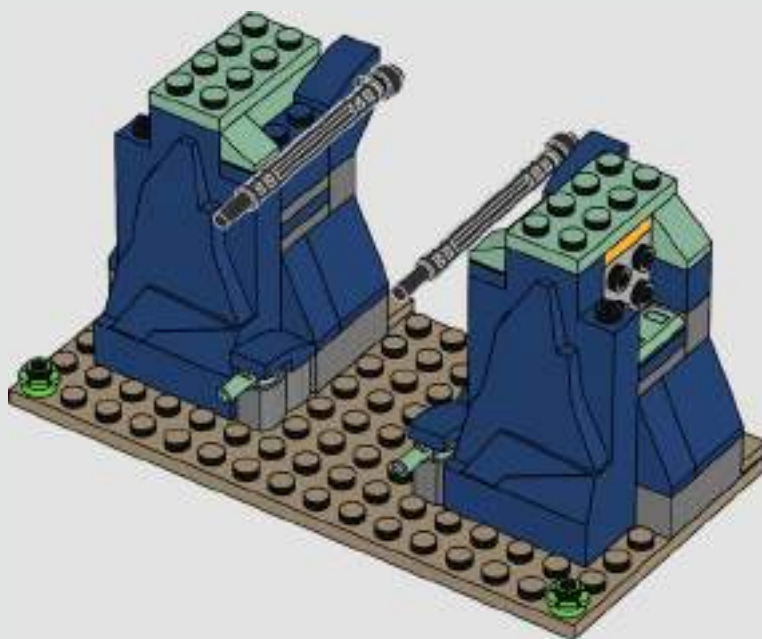



51

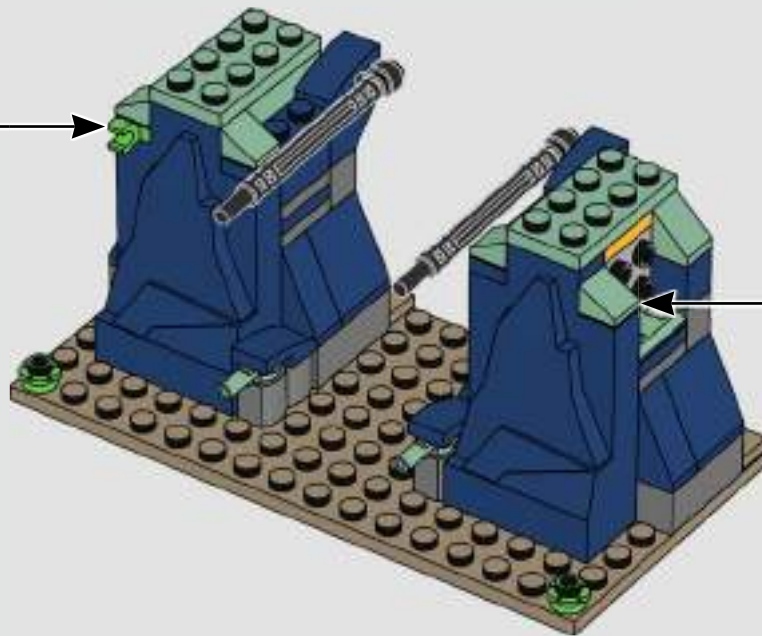
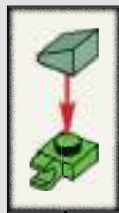



52

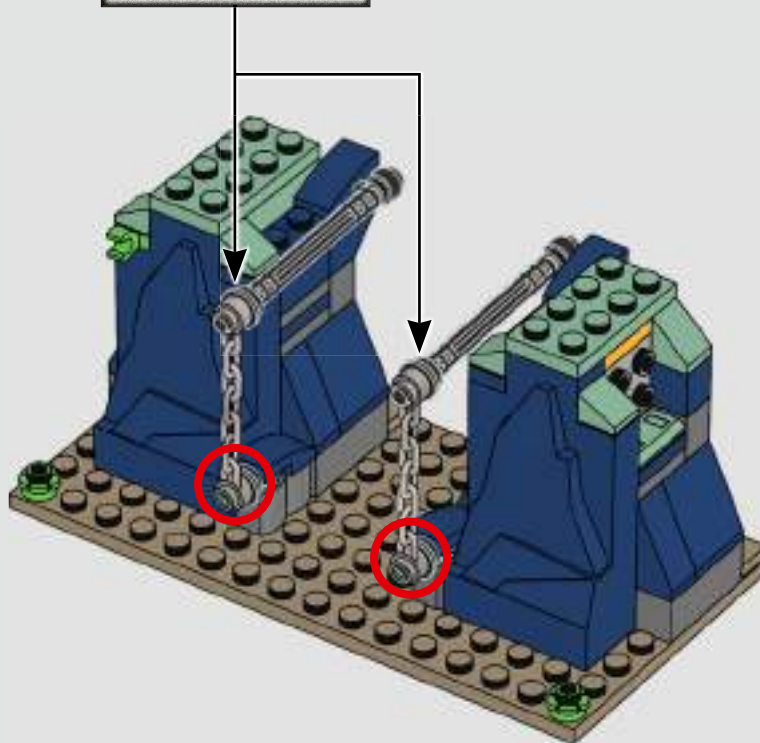
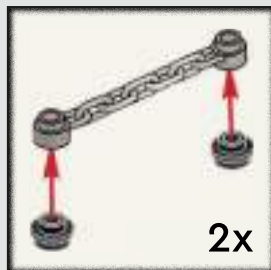



53

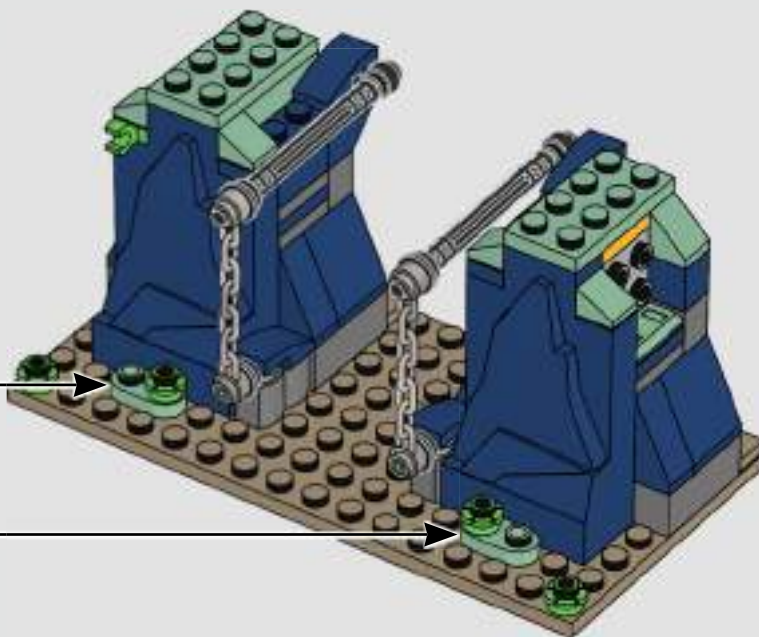



54

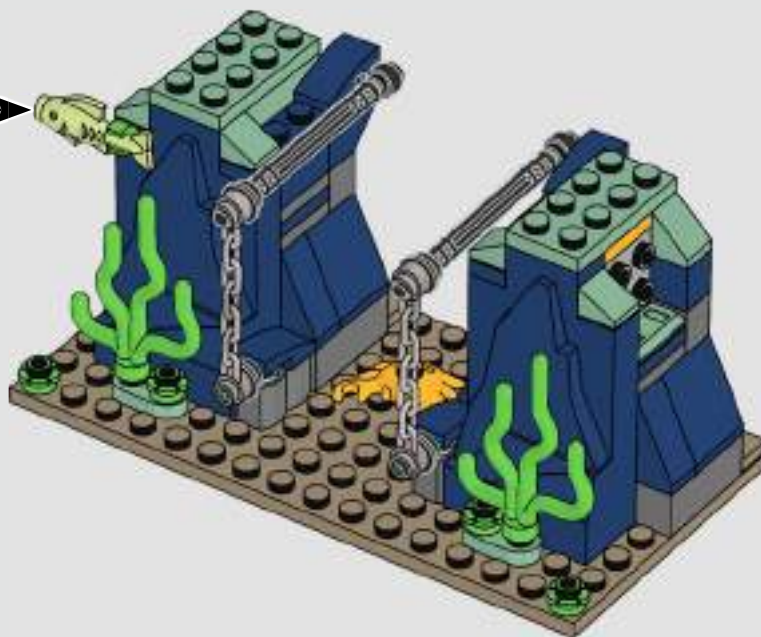



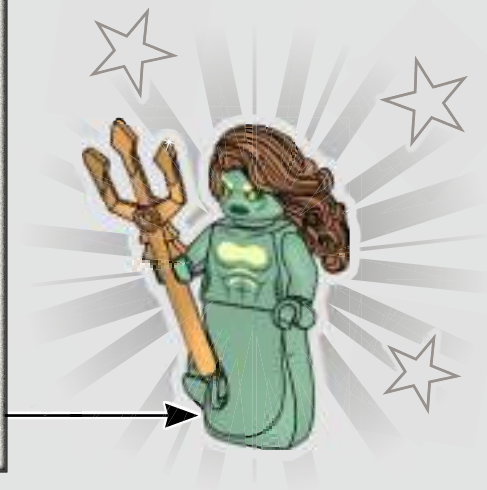
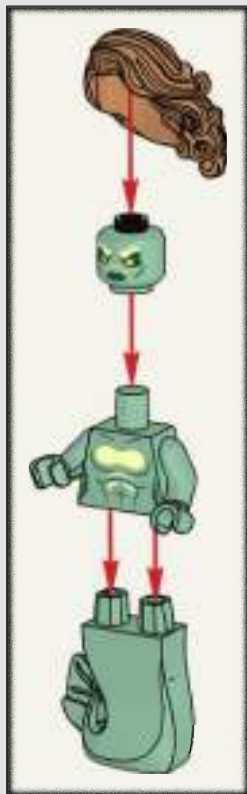



55

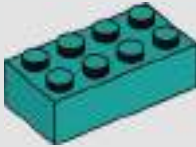

56

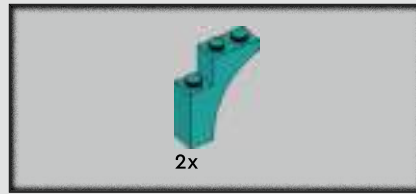
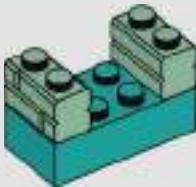

57

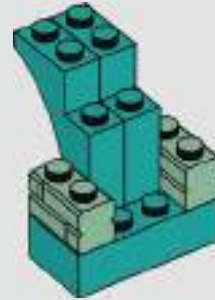

58

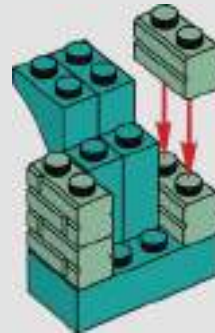

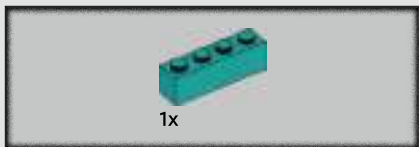

59

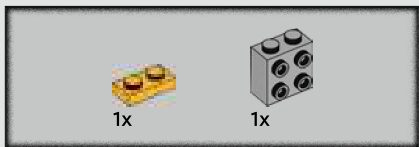
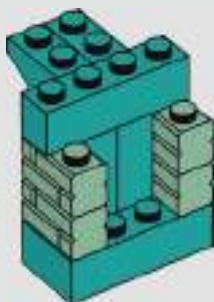

60

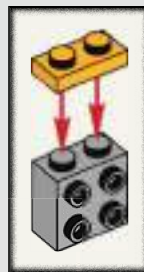
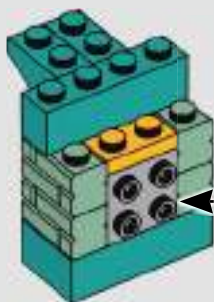

2x

61

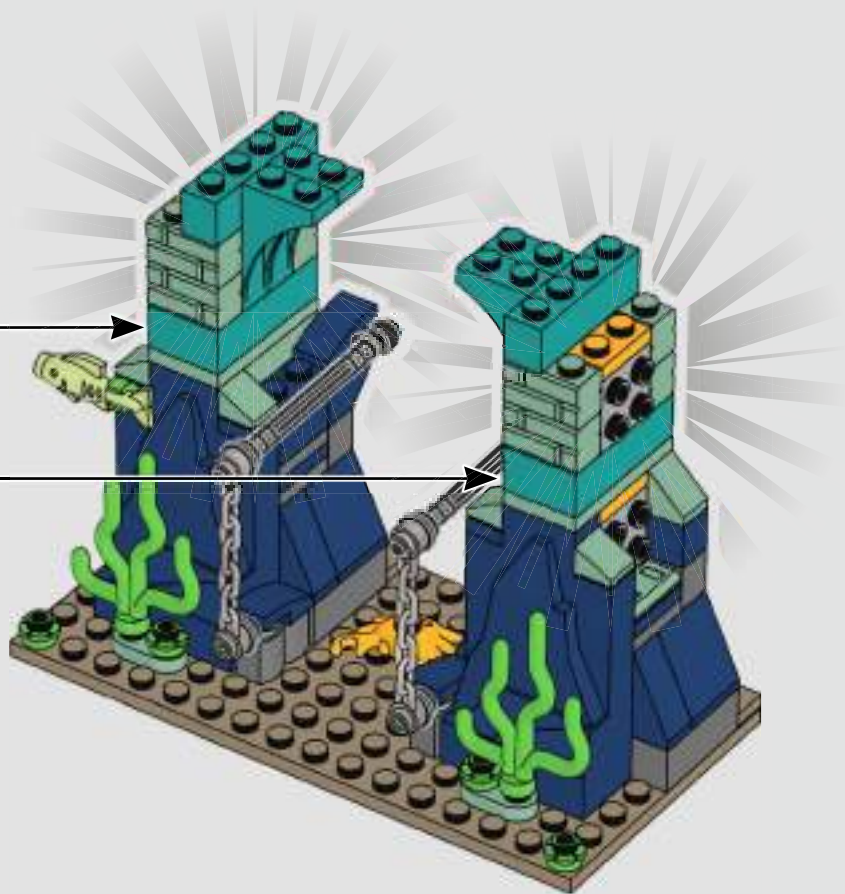

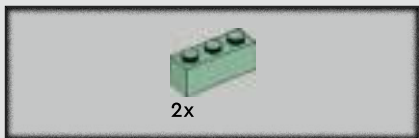

62

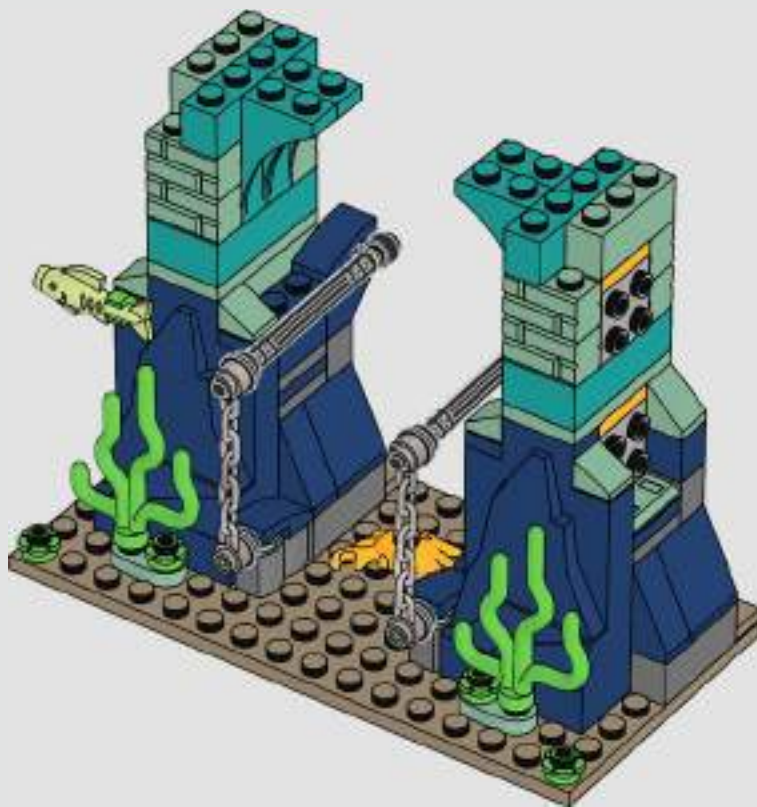



63

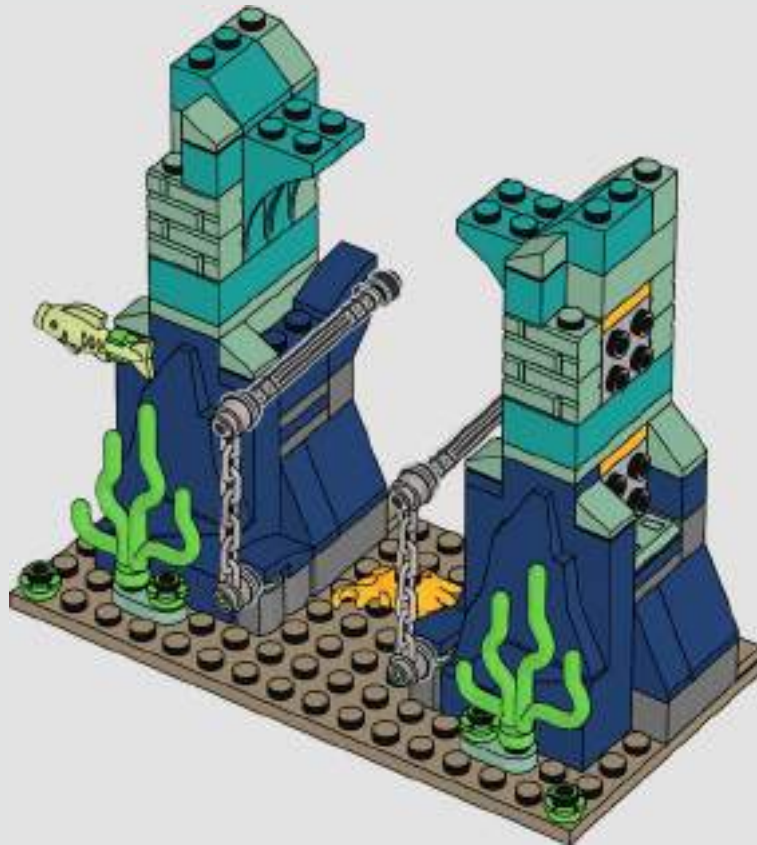



2x



2x

64

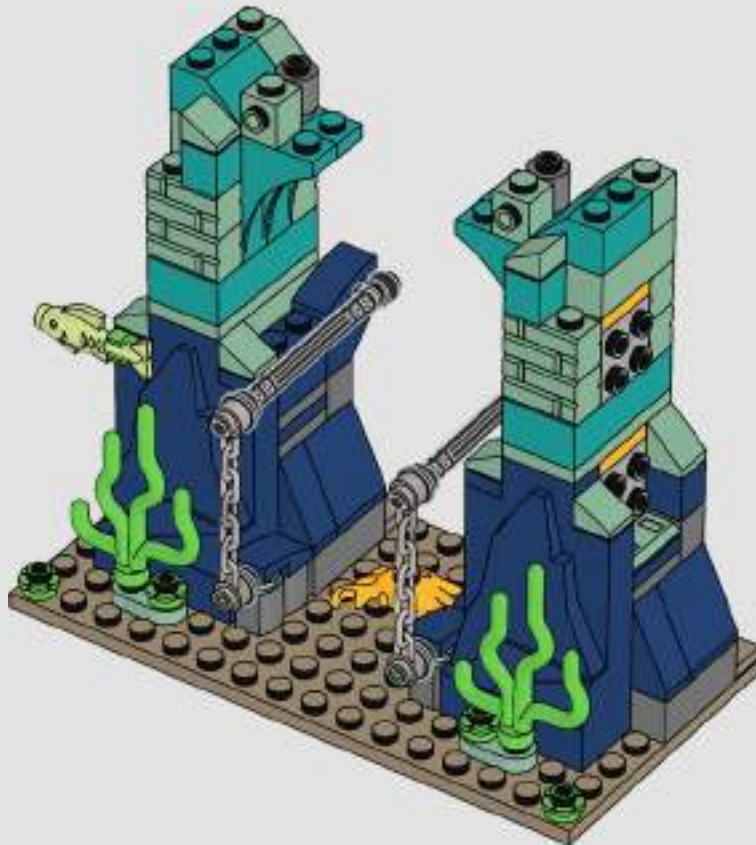

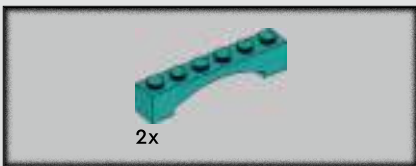

65

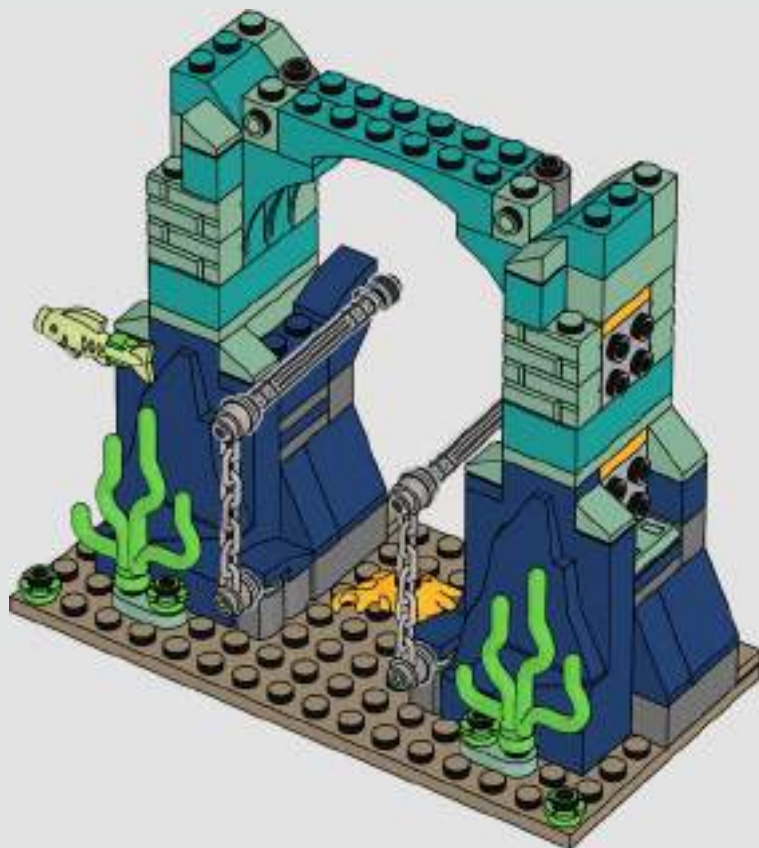



2x

66

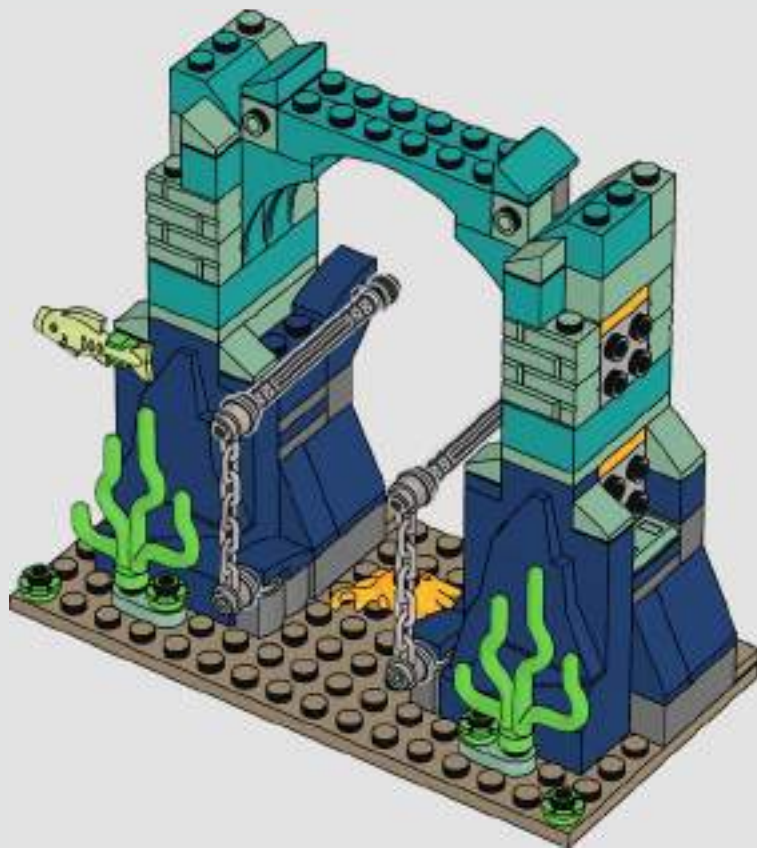



67

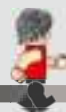
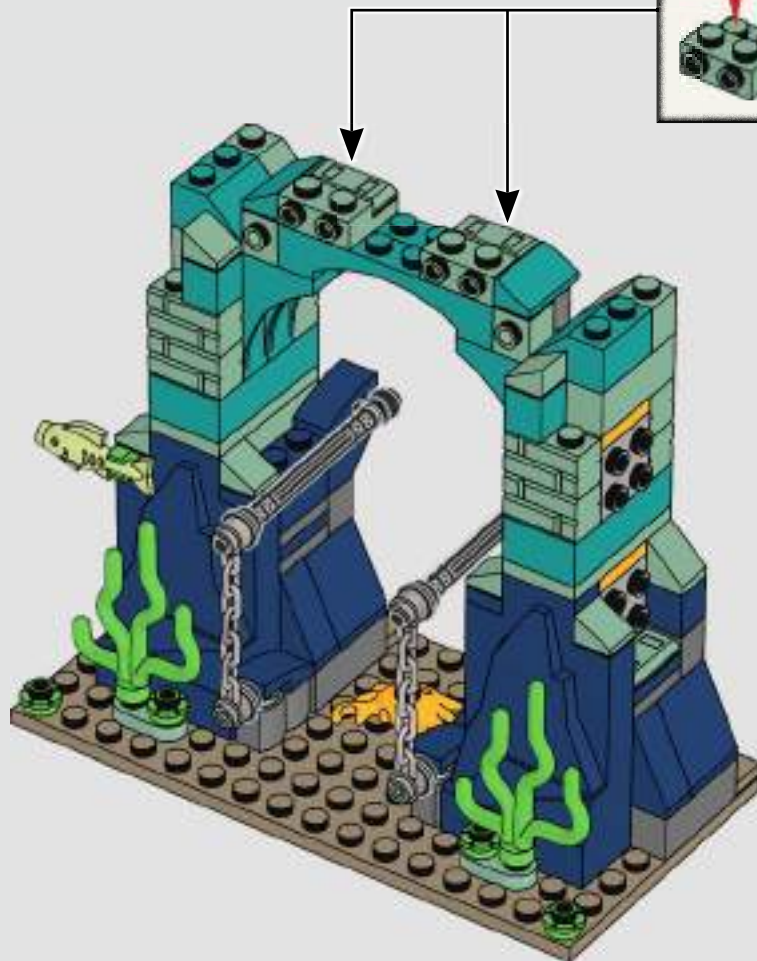
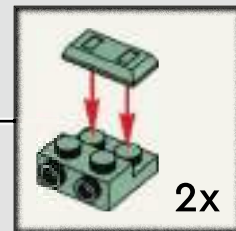

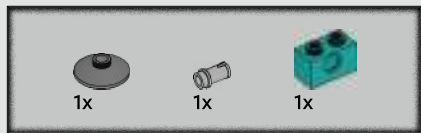

68

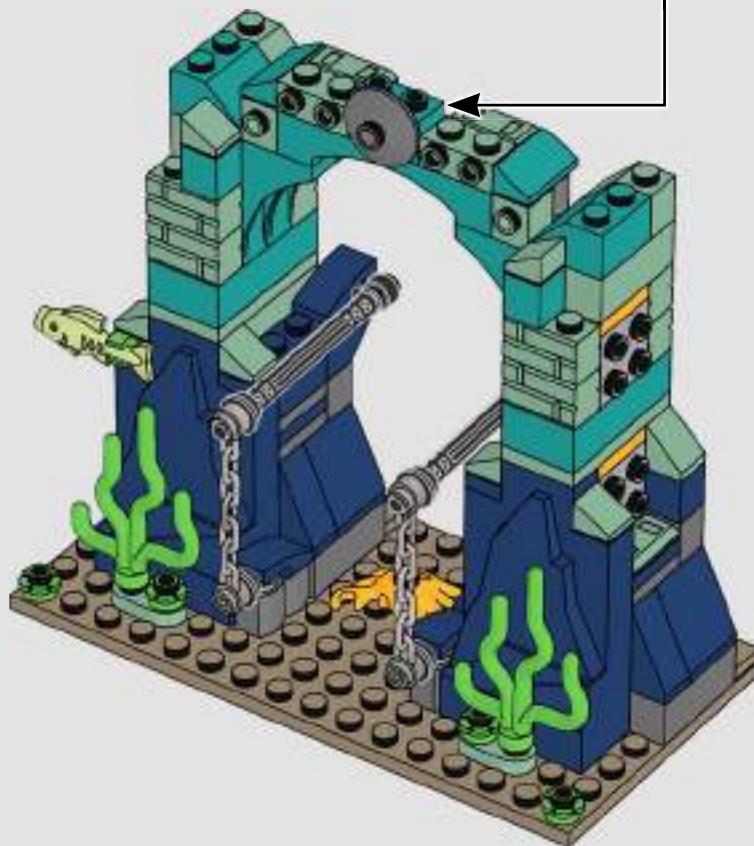
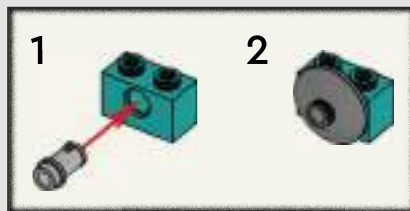



69

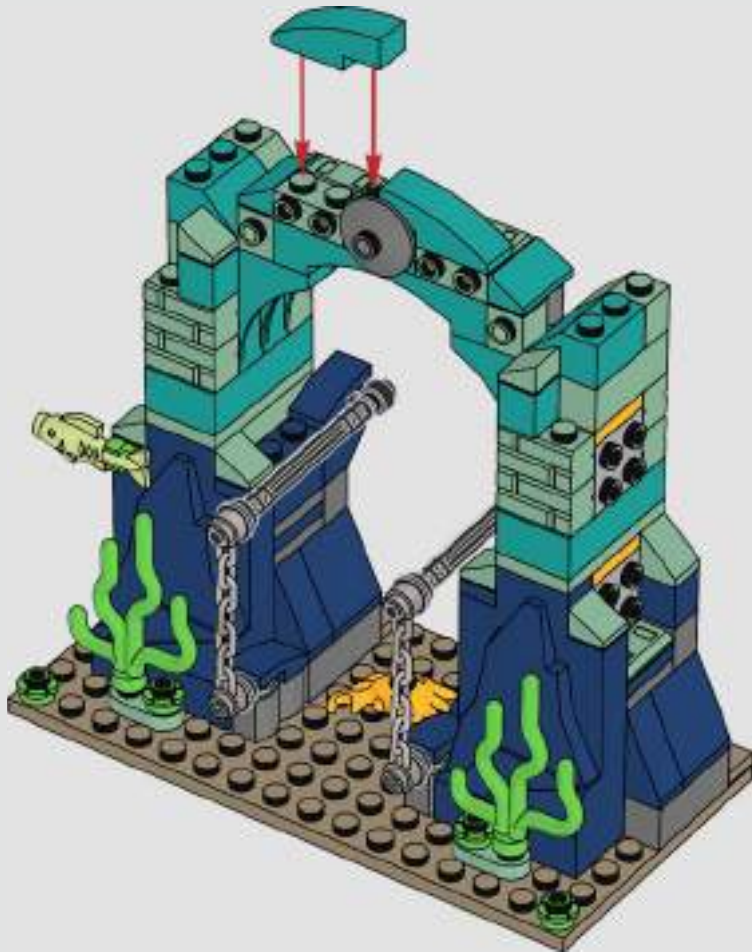



70

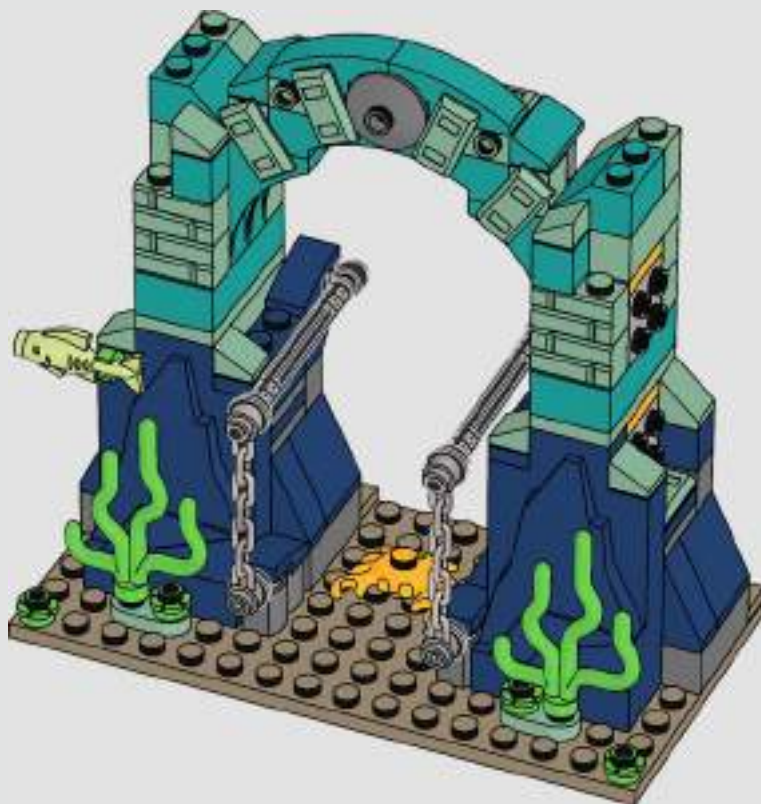

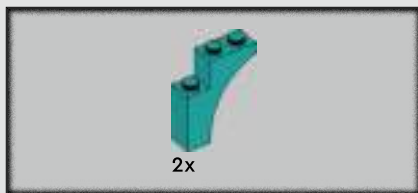

71

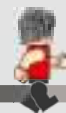
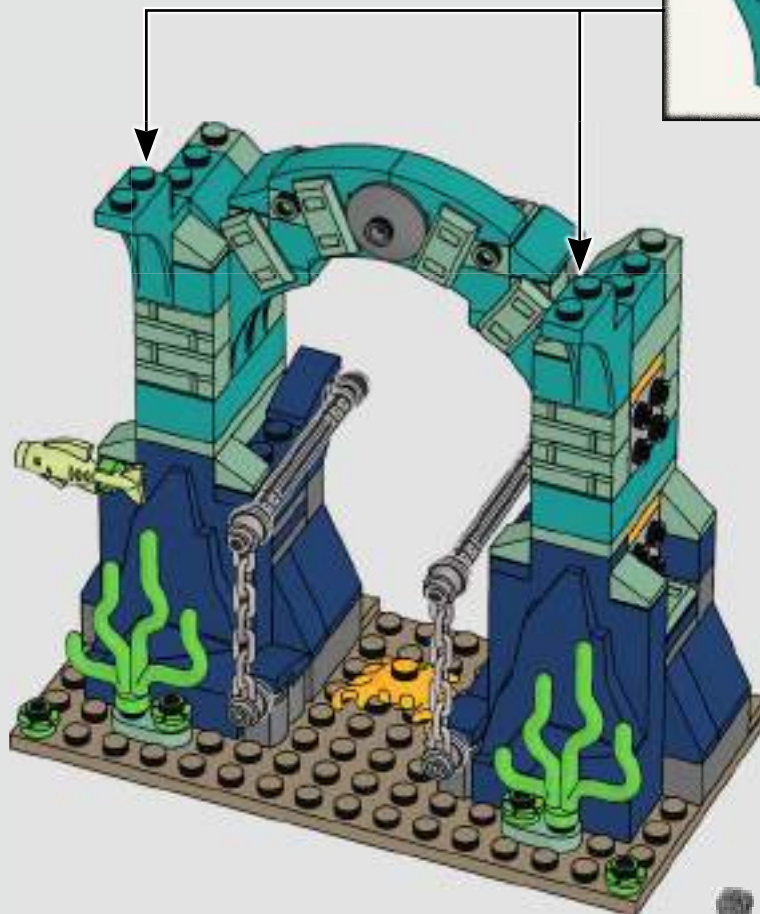
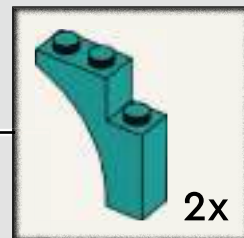

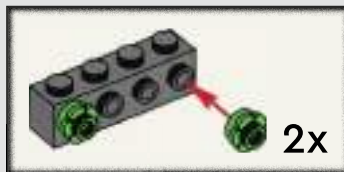
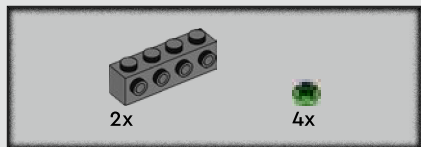

72

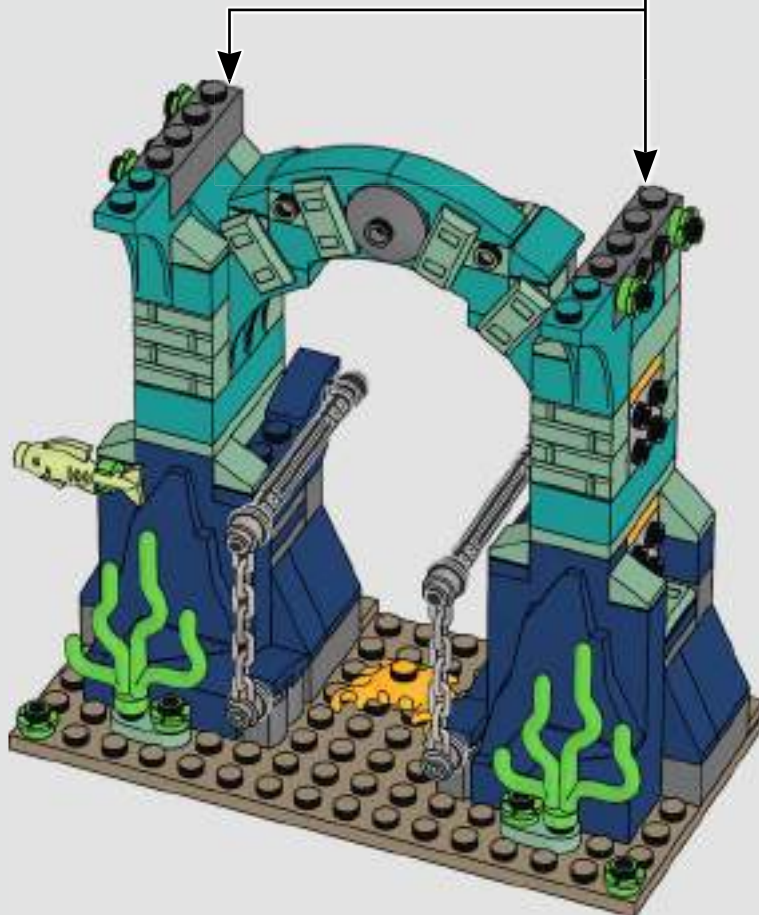

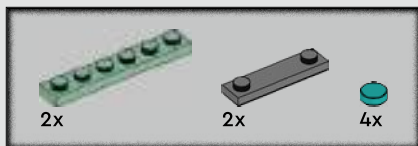

73

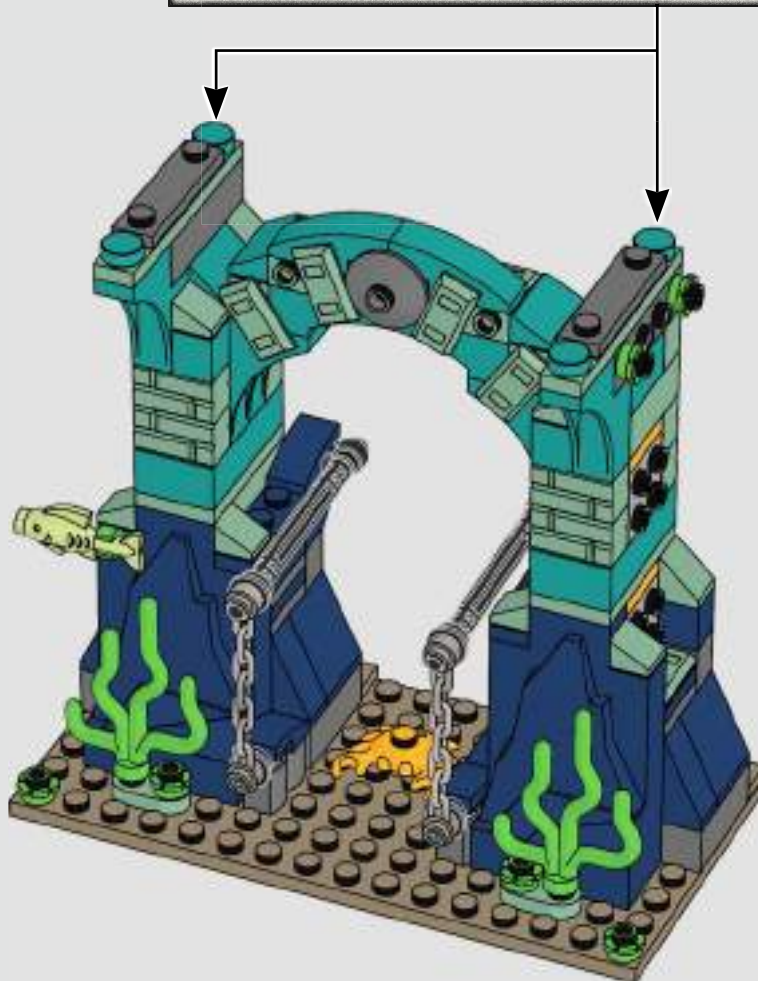
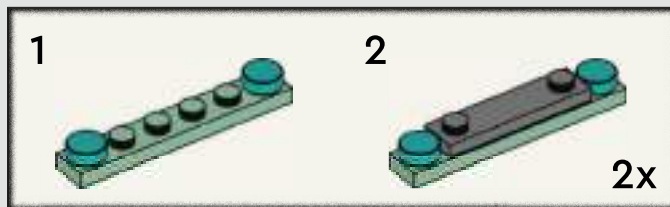

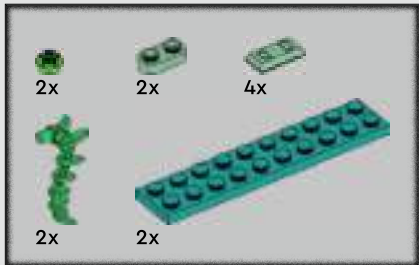

74

1

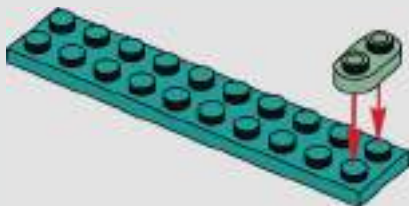

2

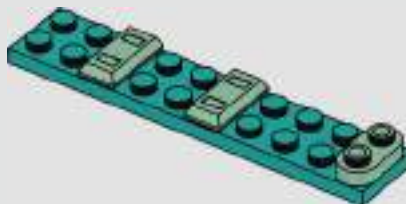

3

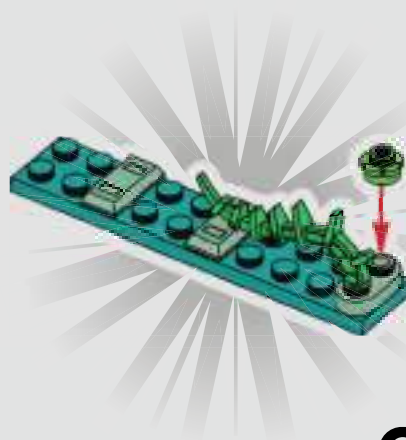

2x

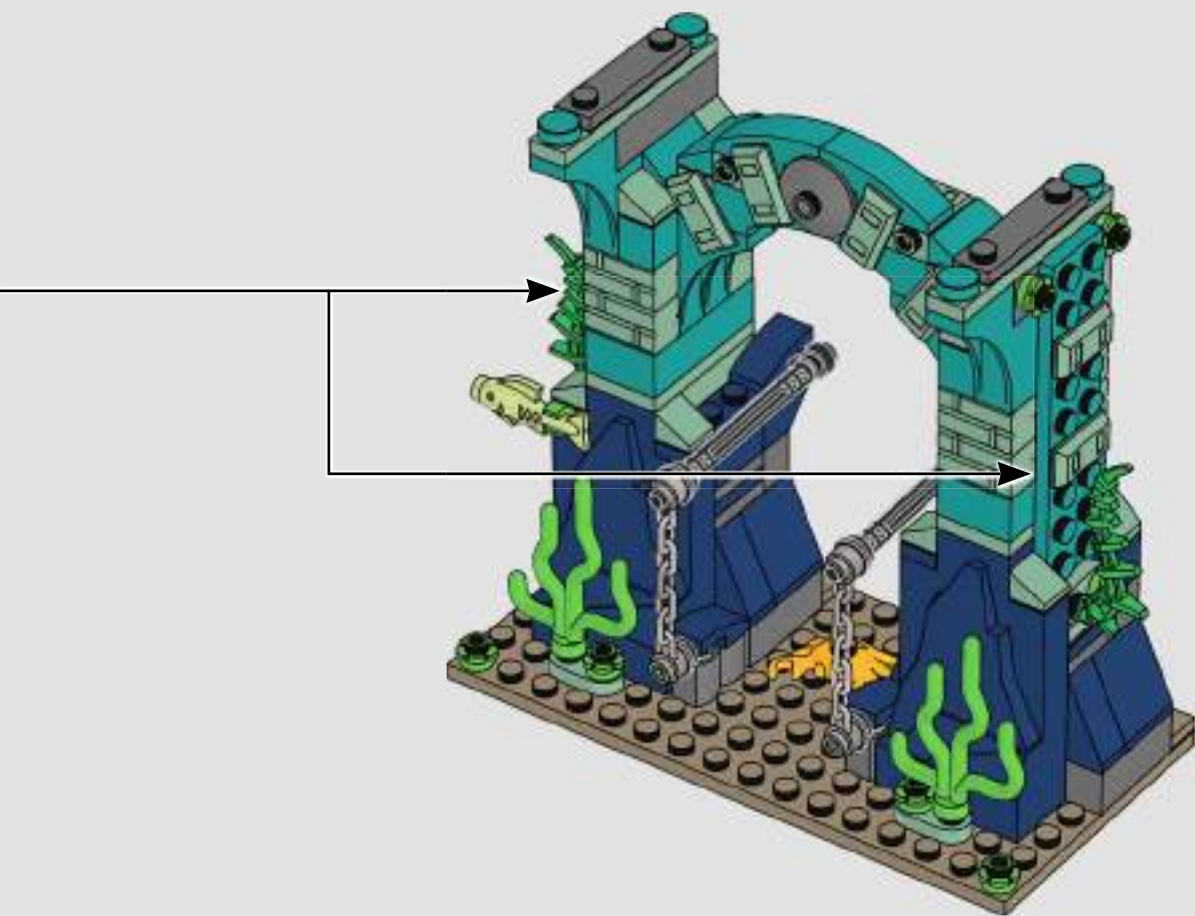

75

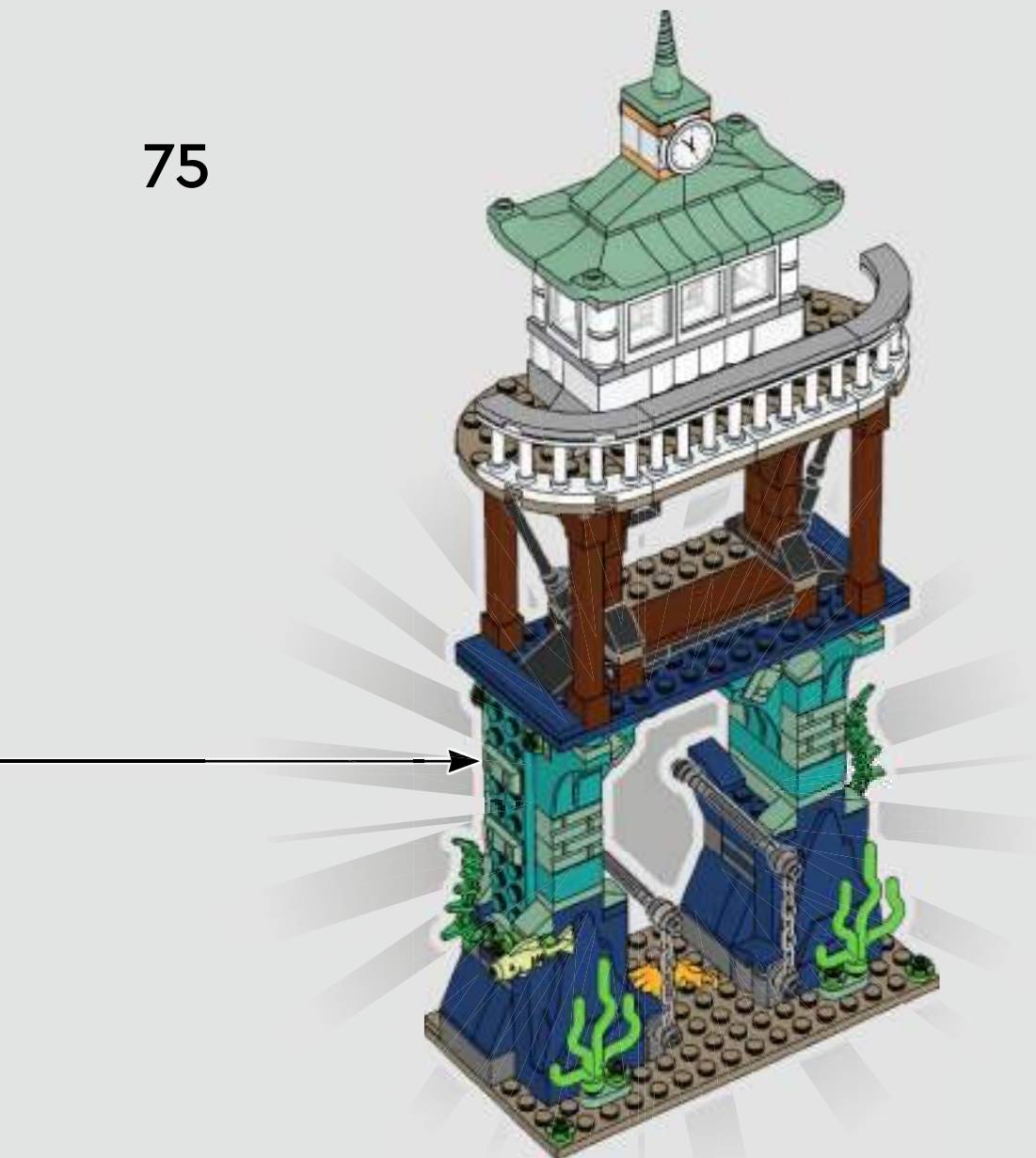



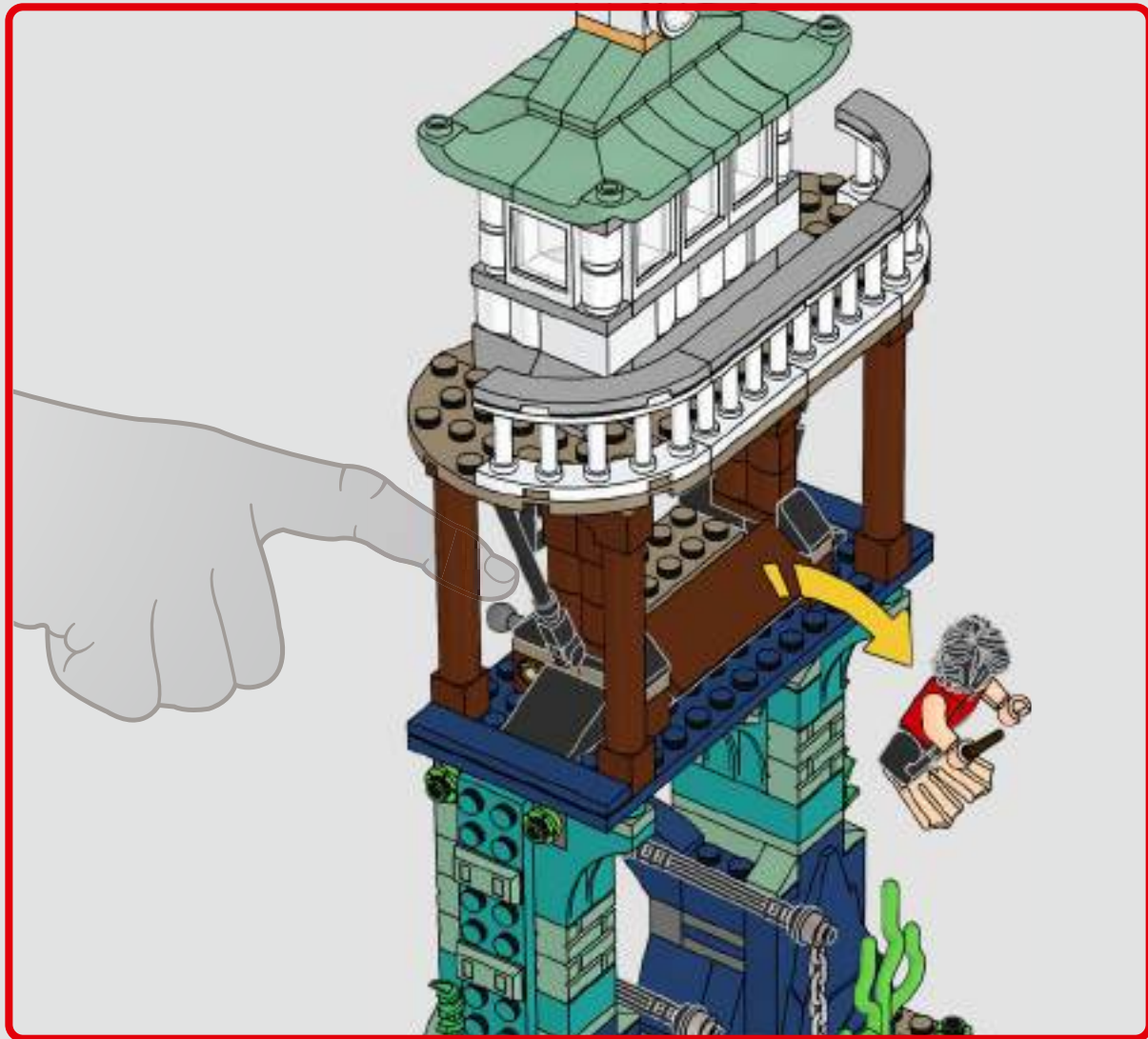







Harry Potter



76420



76413

2x 4252437	2x 244526	2x 329826	1x 6223215	2x 6223171	4x 4520612	2x 4655611	8x 306201
2x 6097498			1x 6134280	1x 6433522	2x 4609635		1x 6329606
4x 6094143	1x 602026	2x 6321194	1x 6420392	1x 6330616	4x 4620075		4x 6059185
				4x 6330616	7x 4211180		1x 6326103
4x 6097429	4x 6168646	2x 6281993	6x 4652205	8x 6369375	2x 4211151		1x 4211585
					2x 6092590		1x 4211483
4x 6097429	2x 4529236		2x 6009656	4x 4598531	2x 6313124		1x 6254404
2x 4296785	1x 4290713		4x 6303004	1x 6437359	1x 6266075		2x 370001
	1x 6356861		2x 6353176		4x 6123809		2x 4211807
4x 6144753	1x 6402958		2x 306826	2x 6357616	4x 6055086		2x 4211398
2x 6233955			2x 6270055	12x 6372467	1x 4658005		2x 4211388
	1x 302026		10x 6206150	4x 6075617	4x 6170527		1x 6433127
2x 4667595	2x 379526		1x 6347296	8x 6083976	2x 6039192		2x 4211353
			2x 6389695	4x 6083976			2x 4211410
2x 6430006	4x 6069000		2x 6192309	4x 6083976			2x 6146188
	2x 6192309			4x 6083976			
2x 6384913	2x 6170421			4x 6186826	2x 6099187		1x 303501
86							

3x
4211445

1x
4560183

1x
4211438

2x
6163989

1x
4211795

1x
4211481

2x
4211090

2x
6364352

1x
4211010

2x
4211095

4x
4211063

1x
4210660

2x
4211043

4x
4211105

2x
4210725

2x
6257592

2x
4210999

1x
6420398

1x
6420382

1x
6420401

1x
6420389

2x
6430008

1x
6093518

5x
6254552

1x
6238046

1x
6420335

2x
6347982

1x
6270032

1x
6284589

1x
6437301

1x
6218359

2x
6236213

2x
6323689

1x
6291414

4x
6028736

1x
6253362

4x
6311437

2x
6228967

1x
6345402

2x
6249419

6x
6293302

2x
6249426

2x
6217660

2x
6249422

2x
6290541

2x
6249538

1x
6002847

1x
6002843

1x
6311435

2x
4528604

1x
6031821

1x
6433530

2x
4507047

2x
6167894

2x
6146989

1x
4246957



1x
4624163



1x
6310975

1x
4505990

2x
6262138

1x
6270116

1x
6335111

1x
4666579

1x
9342

1x
6433954

 [LEGO.com/service](https://www.LEGO.com/service)



YOU COULD **WIN**



Scan this QR code or go to **LEGO.COM/PRODUCTFEEDBACK** and give us your short feedback about this LEGO® set for a chance to win a cool LEGO prize.

Terms and Conditions apply*

DE: Du könntest GEWINNEN. Es gelten die Teilnahmebedingungen* **FR: Tu pourrais GAGNER.** Des conditions s'appliquent* **IT: Potresti VINCERE tu.** Termini e condizioni sono applicabili* **ES: Puedes GANAR.** Aplican términos y condiciones* **PT: Poderá GANHAR.** Aplicam-se termos e condições* **JA: プレゼント付き! 利用規約が適用されます*** **ZH: 轻松获奖. 条款和条件适用*** **KO: 상품의 주인이 되어보세요. 소정의 약관이 적용됩니다*** **RU: Вы можете ВЫИГРАТЬ.** Действуют положения и условия* **PL: Szansa na WYGRANĄ.** Obowiązują warunki korzystania* **CS: Máte šanci VYHRÁT.** Platí všeobecné smluvní podmínky* **SK: Máte šancu VYHRAŤ.** Platia všeobecné zmluvné podmienky* **HU: TE IS NYERHETSZ.** Felhasználási feltételek érvényesek* **RO: Ai putea CÂȘTIGA.** Se aplică termeni și condiții* **BG: Можете да СПЕЧЕЛИТЕ.** Има определени правила и условия* **LV: Tu vari LAIMĒT.** Ir spēkā noteikumi un nosacījumi.* **ET: Sul on võimalus VÕITA.** Kehtivad tingimused* **LT: Jūs galite LAIMĖTI.** Taikomos sąlygos*

*[LEGO.com/productfeedback-terms](https://www.lego.com/productfeedback-terms)

LEGO and the LEGO logo are trademarks of the/son des marques de commerce du/son marcas registradas de LEGO Group. ©2023 The LEGO Group.

WIZARDING WORLD and all related trademarks, characters, names, and indicia are © & ™ Warner Bros. Entertainment Inc.

Publishing Rights © JKR. (s23)