





WE'RE MAKING OUR PACKAGING MORE SUSTAINABLE

We're transitioning from single-use plastic to paper-based packaging. As we progress, you may find a mix of paper and plastic in our boxes.

NOUS RENDONS NOS EMBALLAGES PLUS DURABLES

Nous passons des emballages en plastique à usage unique aux emballages à base de papier. Durant la transition, vous pourriez trouver un mélange de papier et de plastique dans nos boîtes.

QUEREMOS HACER MÁS SUSTENTABLES NUESTROS MATERIALES DE EMBALAJE

Estamos cambiando las bolsas de plástico desechables por bolsas con base de papel. Conforme avanzamos en este propósito, puedes encontrar una mezcla de papel y de plástico en nuestras cajas.

[LEGO.com/sustainable-packaging](https://www.lego.com/sustainable-packaging)

WILD ABOUT FLOWERS LA PASSION DES FLEURS PASIÓN POR LAS FLORES



🌸 "Whether you are growing your LEGO® Botanical Collection or this is your first LEGO flower arrangement, you are probably as wild about flowers as we are. This bouquet is a fresh mix of flowers you might pick for yourself in a field or garden, and we paired colors and complementary species from all over the world to celebrate our planet's biodiversity and the soothing beauty we cherish in nature. Enjoy building!"

🌸 « Que vous cultiviez votre collection botanique LEGO® ou que ce soit votre première décoration florale LEGO, vous aimez probablement les fleurs autant que nous. Ce bouquet est constitué de fleurs que vous pourriez cueillir dans un champ ou un jardin. Nous avons marié des couleurs et des espèces complémentaires provenant du monde entier pour célébrer la biodiversité de notre planète et la beauté apaisante de la nature. Bonne construction ! »

🌸 "Tanto si estás ampliando tu vasta colección LEGO® Botanical como si este set marca tu inicio en el mundo de los arreglos florales LEGO, es muy probable que las flores te causen la misma fascinación que a nosotros. La fresca combinación de este ramo bien podrías haberla recogido tú en un prado o jardín. Los colores y las especies complementarias, provenientes de todo el mundo, están cuidadosamente seleccionados para celebrar la biodiversidad de nuestro planeta y la reconfortante belleza de la naturaleza que tanto apreciamos. ¡Que disfrutes construyendo!"

MILAN MADGE

*Model Designer at the LEGO Group
concepteur de modèles chez le Groupe LEGO
modelista de The LEGO Group*

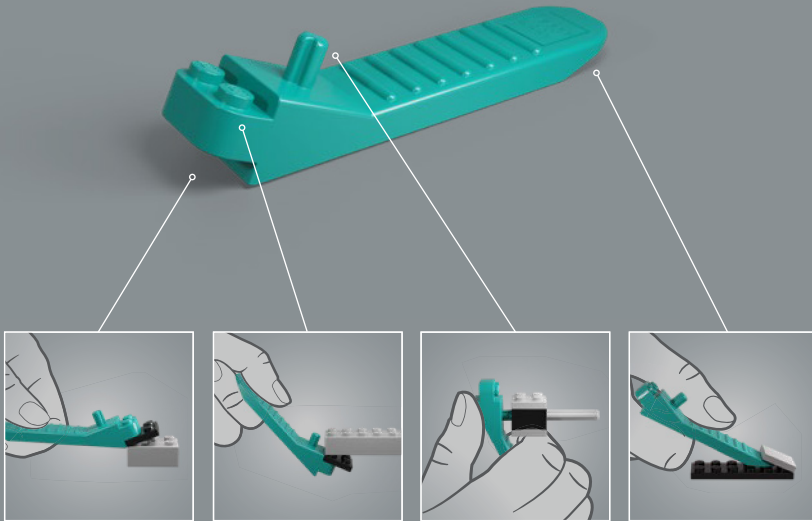

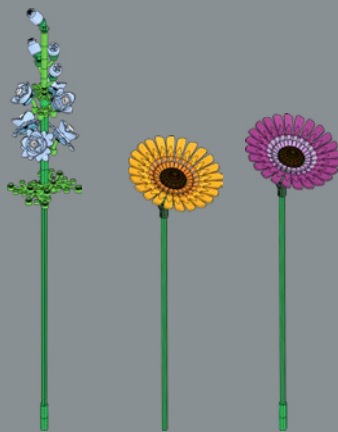
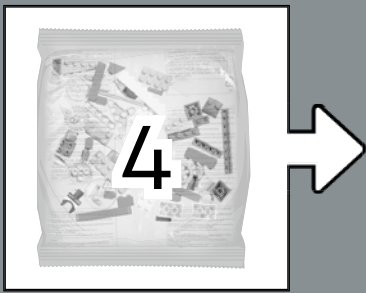
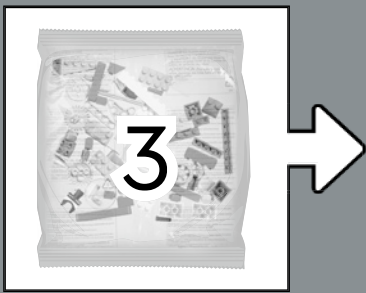
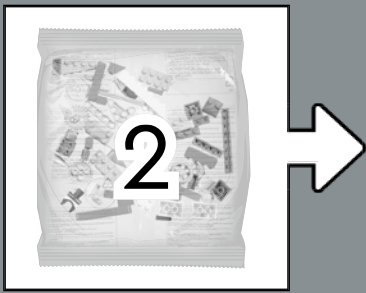
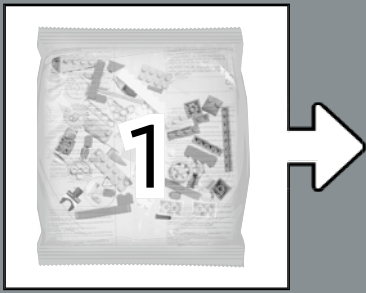

LEATHERLEAF FERN FOUGÈRE DE CUIR HELECHO DE CUERO

(*Rumohra adiantiformis*)

🌸 The lush, bushy Leatherleaf Fern, native to most tropical climates in the Southern Hemisphere, has become popular with garden owners all over the world. Although it does not produce flowers, the feathery foliage is also a beloved favorite in the cut flower industry as a decorative filler in floral arrangements.

🌸 Indigène dans la plupart des climats tropicaux de l'hémisphère sud, la fougère de cuir, luxuriante et touffue, est devenue populaire auprès des propriétaires de jardins du monde entier. Bien qu'elle ne produise pas de fleurs, son feuillage plumeux est également très apprécié dans l'industrie des fleurs coupées en tant que remplissage décoratif dans les décorations florales.

🌸 El exuberante y frondoso helecho de cuero, autóctono en la mayoría de los climas tropicales del hemisferio sur, goza de una gran popularidad entre los propietarios de jardines de todo el mundo. Si bien no produce flores, su tupido follaje es muy apreciado en la industria de las flores cortadas como decoración complementaria para arreglos florales.

COW PARSLEY/ QUEEN ANNE'S LACE PERSIL SAUVAGE/ CERFEUIL DES BOIS PERIFOLLO VERDE/ ENCAJE DE LA REINA ANA

(*Anthriscus Sylvestris*)

🌸 This airy, cloudlike umbrella of tiny white flowers is commonly found in shady areas all over Europe, in Asia and Africa. Its blossom fireworks are a treat for bees, moths, butterflies and other insects looking for pollen in the early spring. Did you know it is also often used as a mosquito repellent?

🌸 Cette ombrelle légère composée de petites fleurs blanches se trouve dans les zones ombragées à travers l'Europe, l'Asie et l'Afrique. Ses fleurs en feux d'artifice sont un régal pour les abeilles, les papillons de nuit, les papillons et autres insectes à la recherche de pollen au début du printemps. Saviez-vous qu'elle est aussi souvent utilisée comme répulsif contre les moustiques ?

🌸 Es común encontrar este vaporoso cúmulo de pequeñas flores blancas en zonas sombreadas a lo largo de Europa, Asia y África. Semejante a un espectáculo de fuegos artificiales, su tupida floración es un festín para las abejas, polillas, mariposas y otros insectos que buscan polen en los primeros días de la primavera. ¿Pero sabías que también se utiliza como repelente de mosquitos?



🌸 A sure sign of spring and summer in the British Isles and Western Europe is the arrival of the soft, golden Welsh Poppy in hedgerows, fields and roadsides. Despite its tender frame and petals, it also thrives in rocky environments with very little soil and in cracks in your paved garden or city sidewalks.

🌸 Un signe incontestable du printemps et de l'été dans les îles britanniques et en Europe occidentale est l'arrivée du pavot du Pays de Galles, délicat et doré, dans les haies, les champs et les bords de route. Malgré la fragilité de sa tige et de ses pétales, il prospère également dans les environnements rocheux avec très peu de terre et dans les fissures de votre jardin pavé ou des trottoirs urbains.

🌸 Tanto en las islas británicas como por toda Europa occidental, la primavera y el verano no estarían completos sin la presencia de la sutil amapola amarilla en setos, prados y bordes de carreteras. A pesar de la aparente fragilidad de su constitución y sus pétalos, es capaz de sobrevivir en entornos rocosos con muy poca tierra y en las grietas de jardines y aceras adoquinadas.

WELSH POPPY PAVOT DU PAYS DE GALLES AMAPOLA AMARILLA

(*Meconopsis cambrica/
Papaver cambricum*)

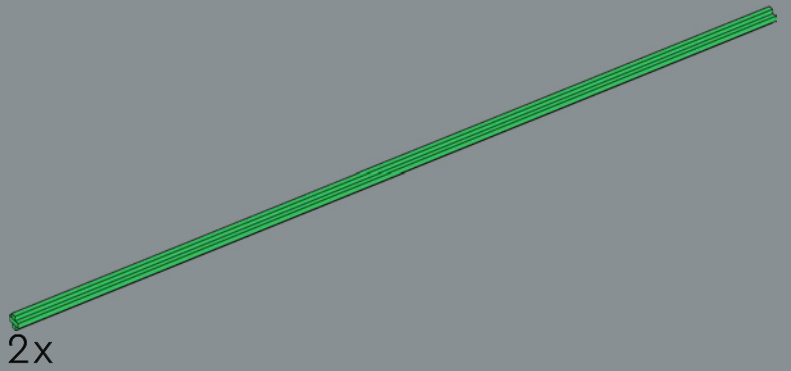
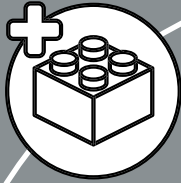

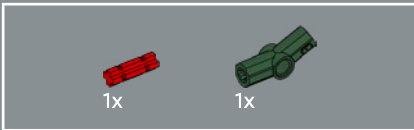

1

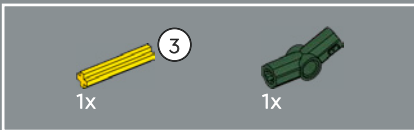
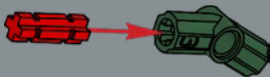

2

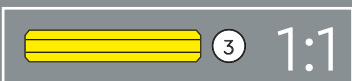
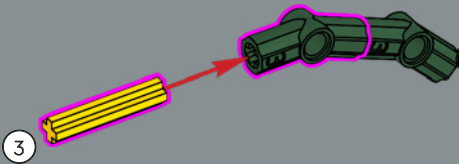

3

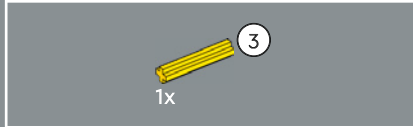
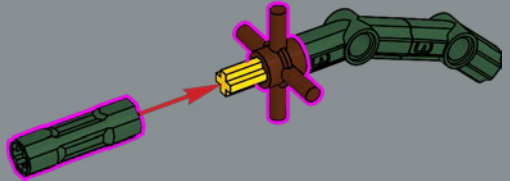

4

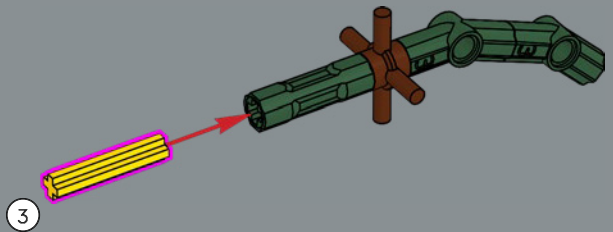

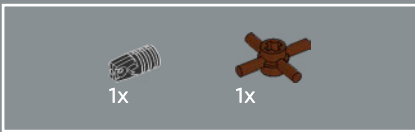

5

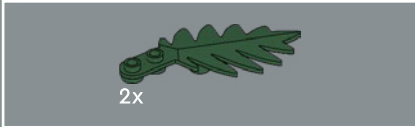
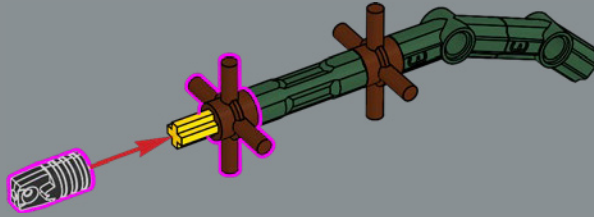

6

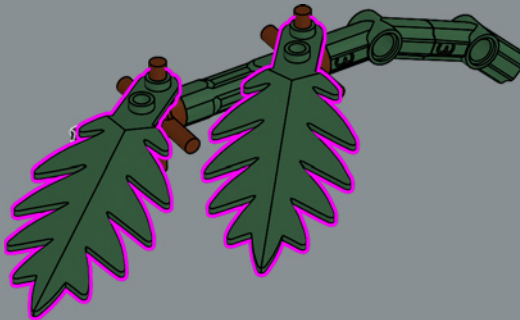

The palm leaf element was first introduced in our LEGO® Pirates theme in the 1990s. Now it is repurposed to create the Leatherleaf Fern.

L'élément de feuille de palmier est apparu pour la première fois dans notre thème LEGO® Pirates dans les années 1990. Il est maintenant réutilisé pour créer la fougère de cuir.

El elemento con forma de hoja de palma se introdujo en los años 90 para el tema LEGO® Pirates. Se le ha encontrado un nuevo uso recreando el helecho de cuero.

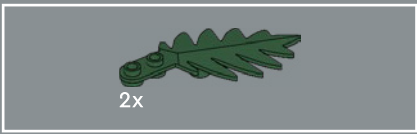

7

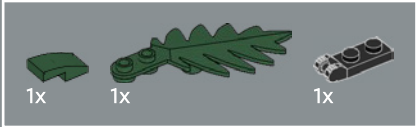

8

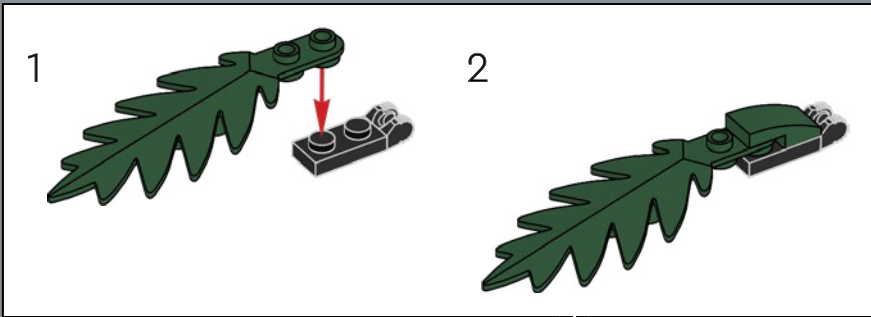

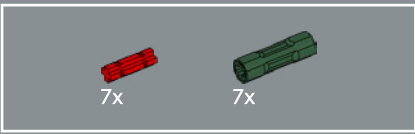

9

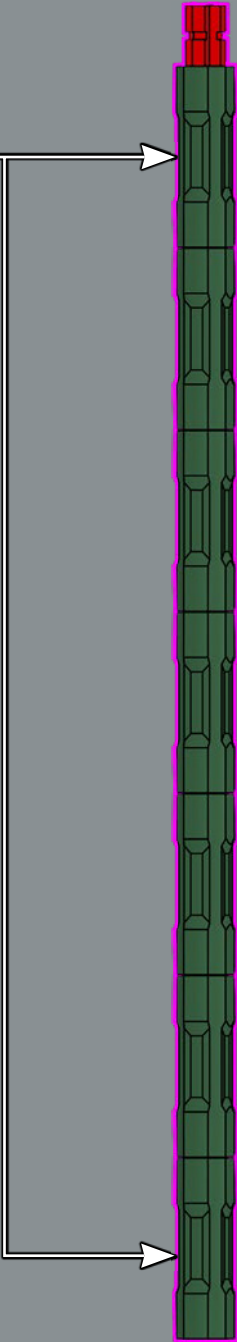
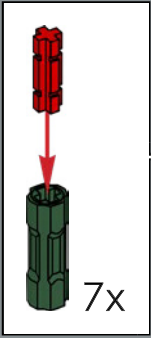

1:1

10

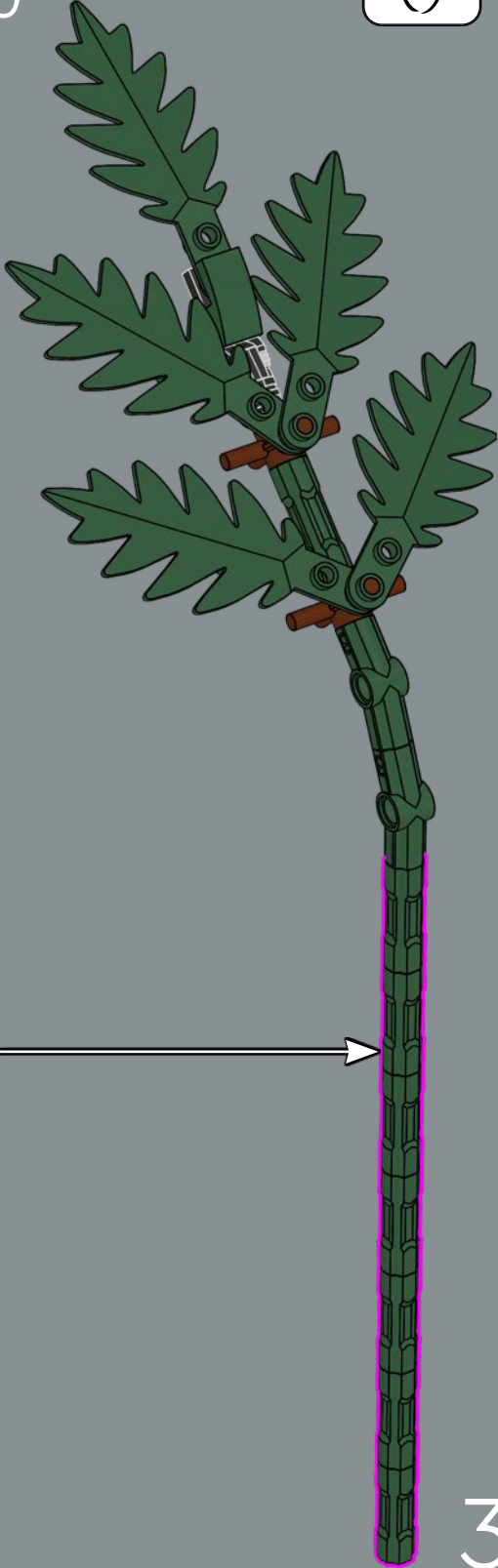

3x

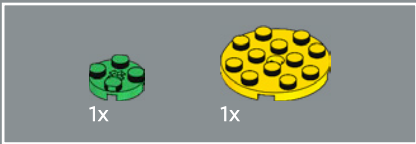
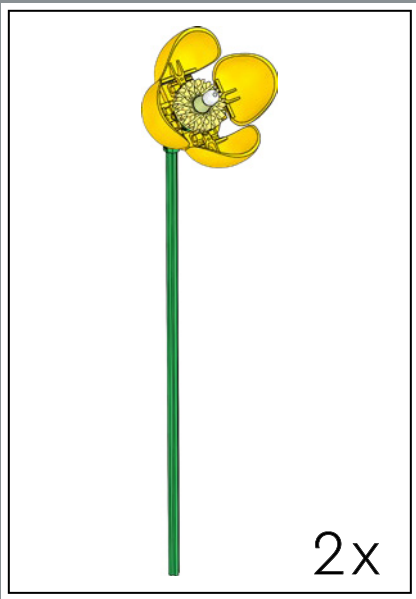

1

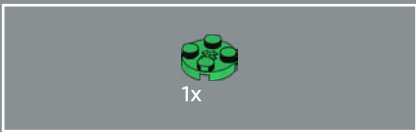
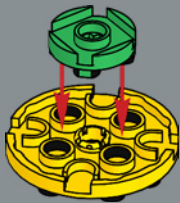

2

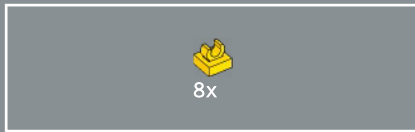

3

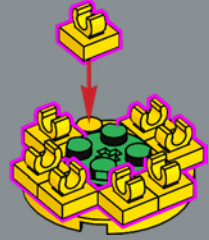

4

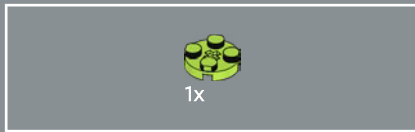
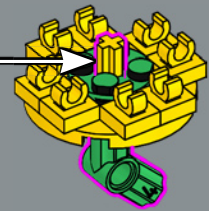
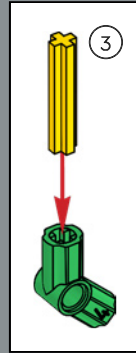

5

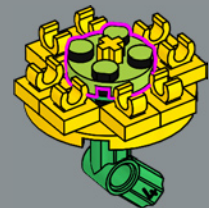



Using existing elements in unusual ways is at the heart of LEGO® building. Here a car hub is used to represent the stigma at the center of the Welsh Poppy.

L'utilisation inhabituelle d'éléments existants est au cœur de la construction LEGO®. Ici, un moyeu de voiture est utilisé pour représenter les stigmates au centre du pavot du Pays de Galles.

Usar elementos existentes de formas inusuales es la esencia de la construcción con LEGO®. Aquí se ve la copa de una rueda de auto representando el estigma de una amapola amarilla.

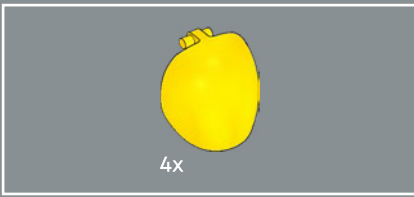

6

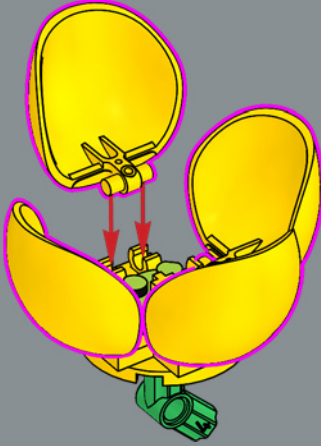

7

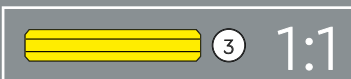
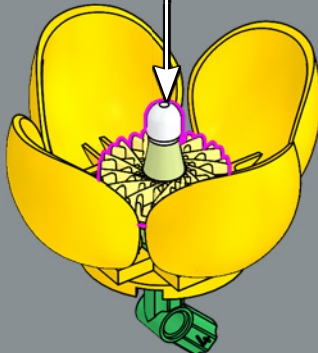
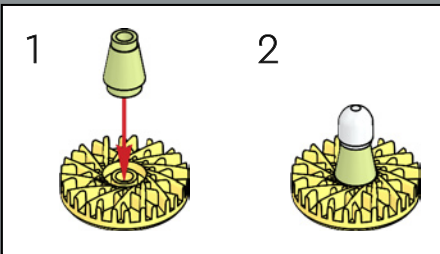

8

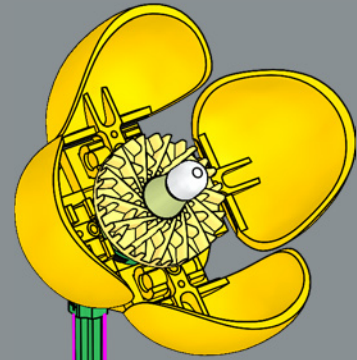

32

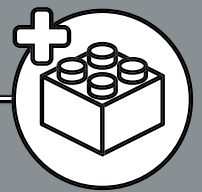

2x

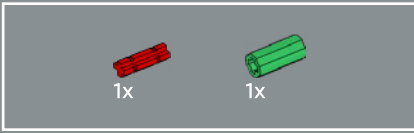
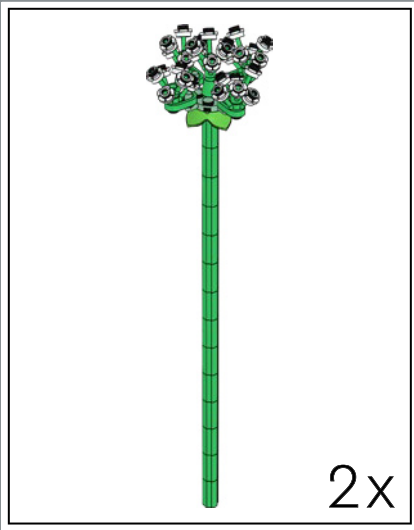

1

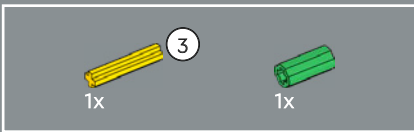

2

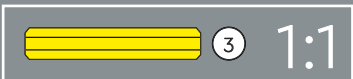

3

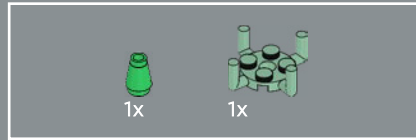

4

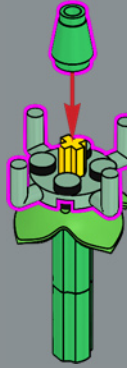

5

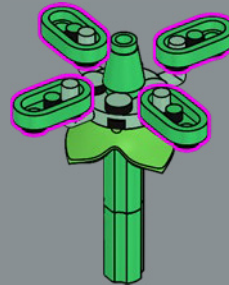

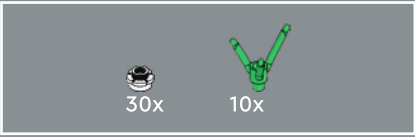
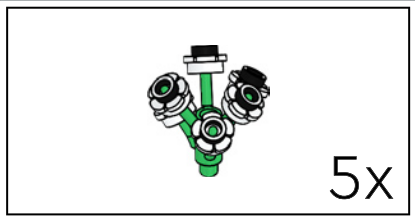

6

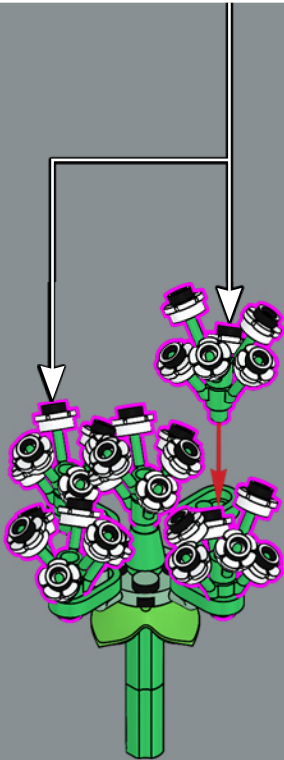
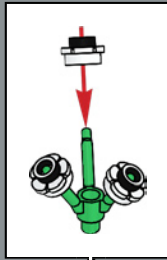
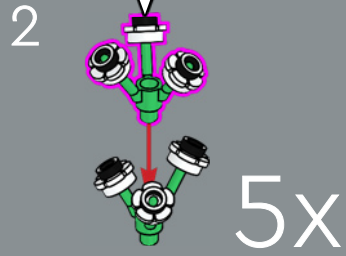
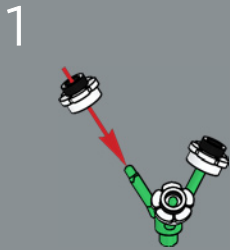

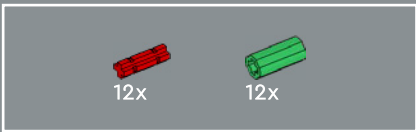

7

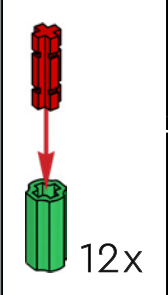

1:1



The nickname Queen Anne's Lace traces back to an old saying that flowers would bloom for Anne, Queen of Great Britain (1702-1707) and her ladies-in-waiting as a complement to their lace dresses.

Le surnom anglais du persil sauvage, « Queen Anne's Lace » (« dentelle de la reine Anne »), provient d'un vieux dicton selon lequel les fleurs fleurissaient pour Anne, reine de Grande-Bretagne (1702-1707) et ses dames d'honneur, pour accompagner leurs robes en dentelle.

El apodo "encaje de la reina Ana" se remonta la antigüedad, cuando se decía que las plantas florecerían para reverenciar la belleza de los vestidos de encaje de Ana, la reina de Gran Bretaña (1702-1707), y sus damas de honor.

8

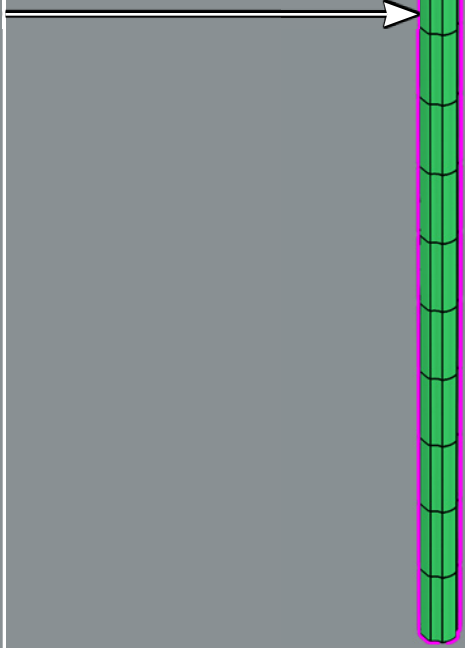

2x



CORNFLOWER CENTAURÉE BLEUET PINCEL

(Centaurea cyanus)



✿ The brightly colored, paper-light Cornflower decorates fields and gardens alike in white, pink and blue from early to mid-summer, particularly in Europe, North America and Asia. Its delicate fragrance and nectar attract butterflies and bees, making the Cornflower an alluring companion to your vegetable garden or orchard.

✿ De couleur vive et légère comme du papier, la centaurée bleuet pare les champs et les jardins de blanc, de rose et de bleu du début au milieu de l'été, notamment en Europe, en Amérique du Nord et en Asie. Son parfum délicat et son nectar attirent les papillons et les abeilles. La centaurée bleuet est donc un compagnon attrayant pour votre potager ou votre verger.

✿ Ligeros como el papel, los pinceles decoran prados y jardines con sus brillantes tonalidades de blanco, rosa y azul desde el inicio y hasta mediados del verano, particularmente en Europa, Norteamérica y Asia. Su delicada fragancia y su néctar atraen a mariposas y abejas, por lo que son un complemento ideal para tu jardín o huerto de verduras.

LAVENDER LAVANDE LAVANDA

(Lavandula)

✿ An evergreen shrub with bursting pops of purple colors and a soothing aroma, the ornamental Lavender is as purposeful as it is decorative. Native to the Mediterranean, the Middle East and North Africa, it is widely used as an aromatic culinary herb, for the distillation of essential oils for cosmetics and in herbal medicines.

✿ Un sous-arbrisseau à feuilles persistantes aux couleurs violettes éclatantes et à l'arôme apaisant, la lavande ornementale est aussi utile que décorative. Originnaire de la Méditerranée, du Moyen-Orient et de l'Afrique du Nord, elle est couramment utilisée comme herbe aromatique culinaire, pour la distillation d'huiles essentielles pour les cosmétiques et dans les médicaments à base de plantes.

✿ Un arbusto siempre verde con brotes de colores violeta y un relajante aroma, la siempre vistosa lavanda es tan práctica como atractiva. Originaria del Mediterráneo, el Medio Oriente y el norte de África, se utiliza ampliamente como hierba aromática para cocinar, para la destilación de aceites esenciales para cosméticos y en la medicina herbolaria.

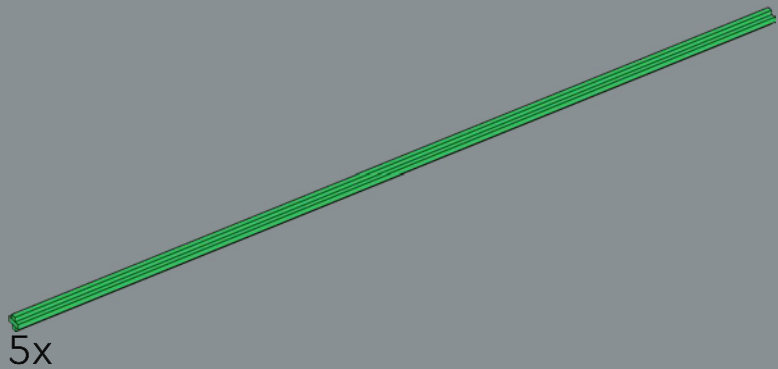
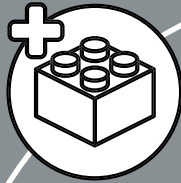

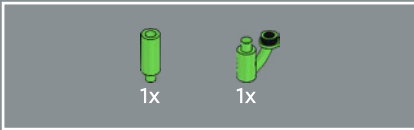
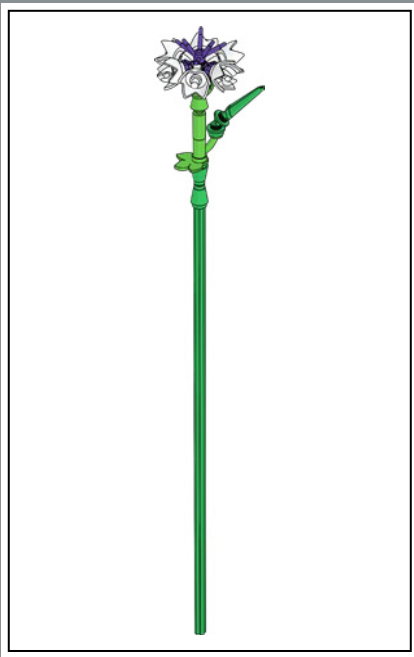

1

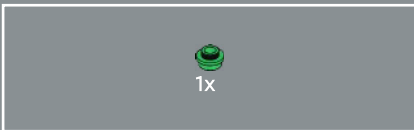

2

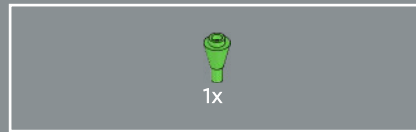
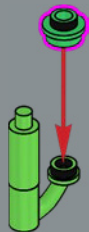

3

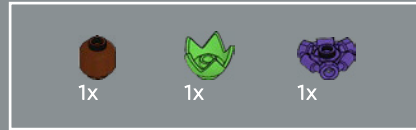
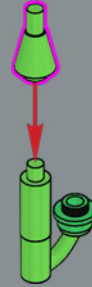

4

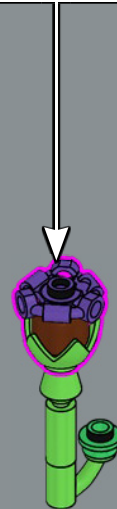



3x



3x

5

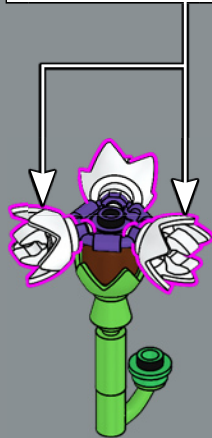
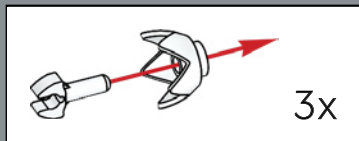

3x

6

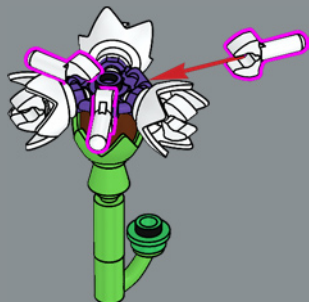

3x

7

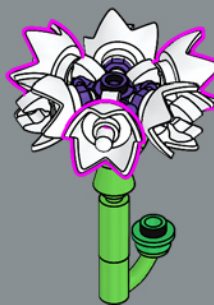

1x

8

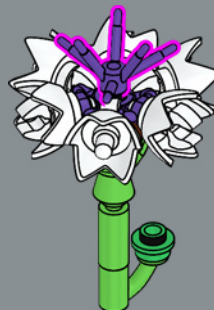

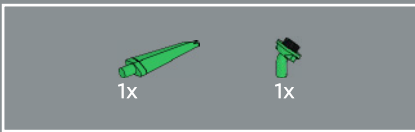

9

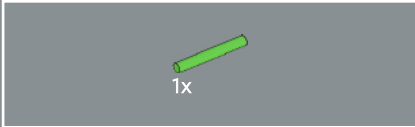
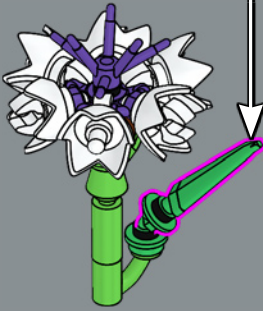
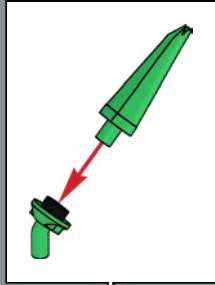

10

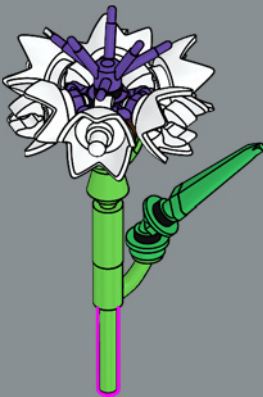

11

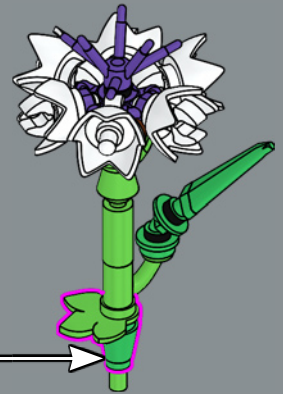
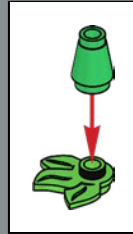



12

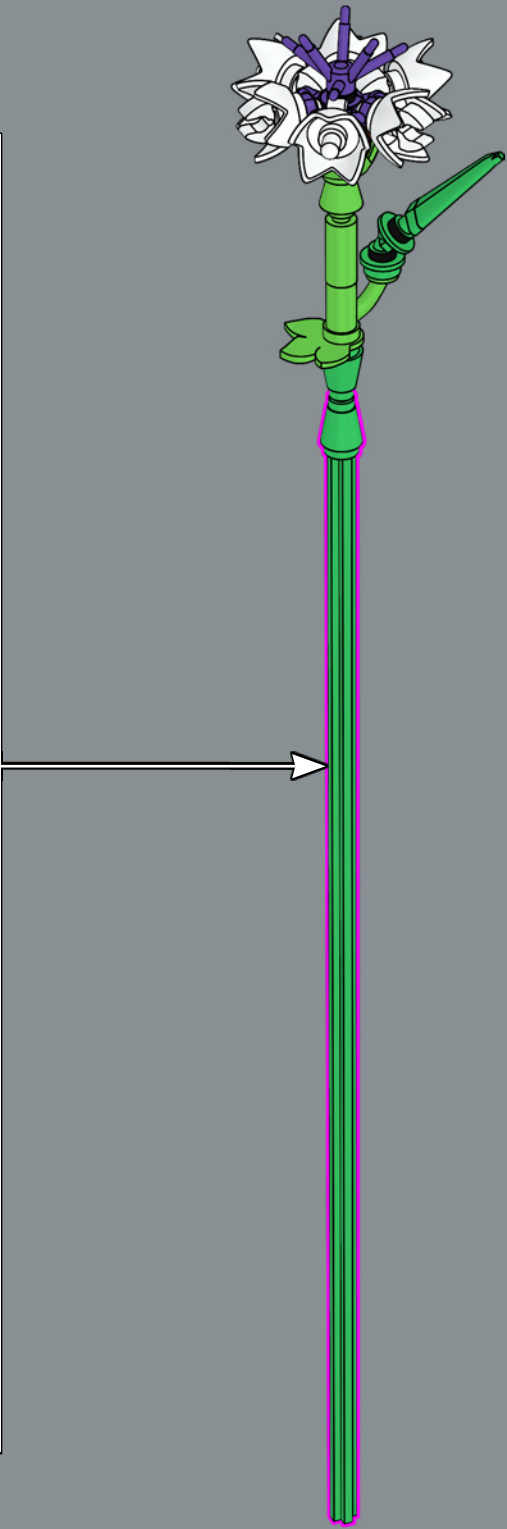
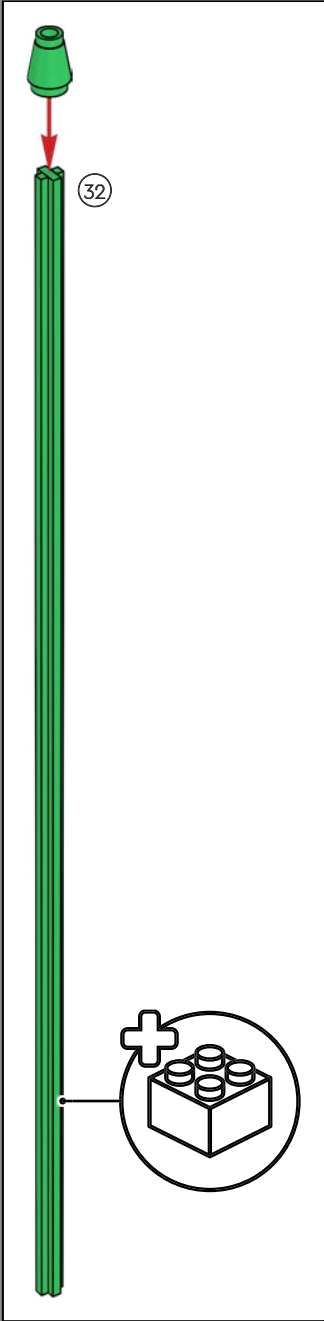

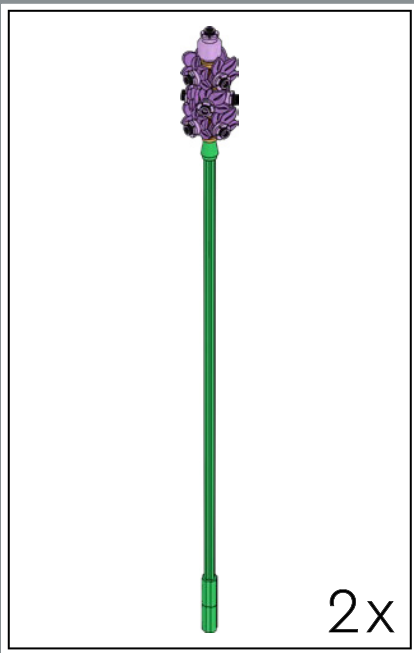

1



2



3

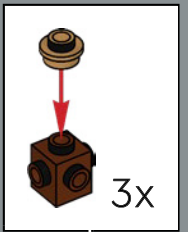

4

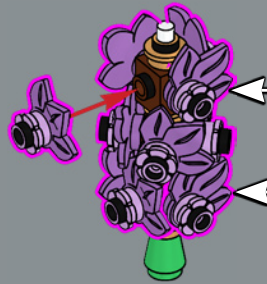
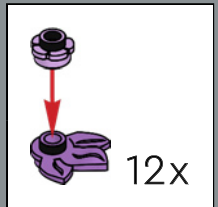

5





6

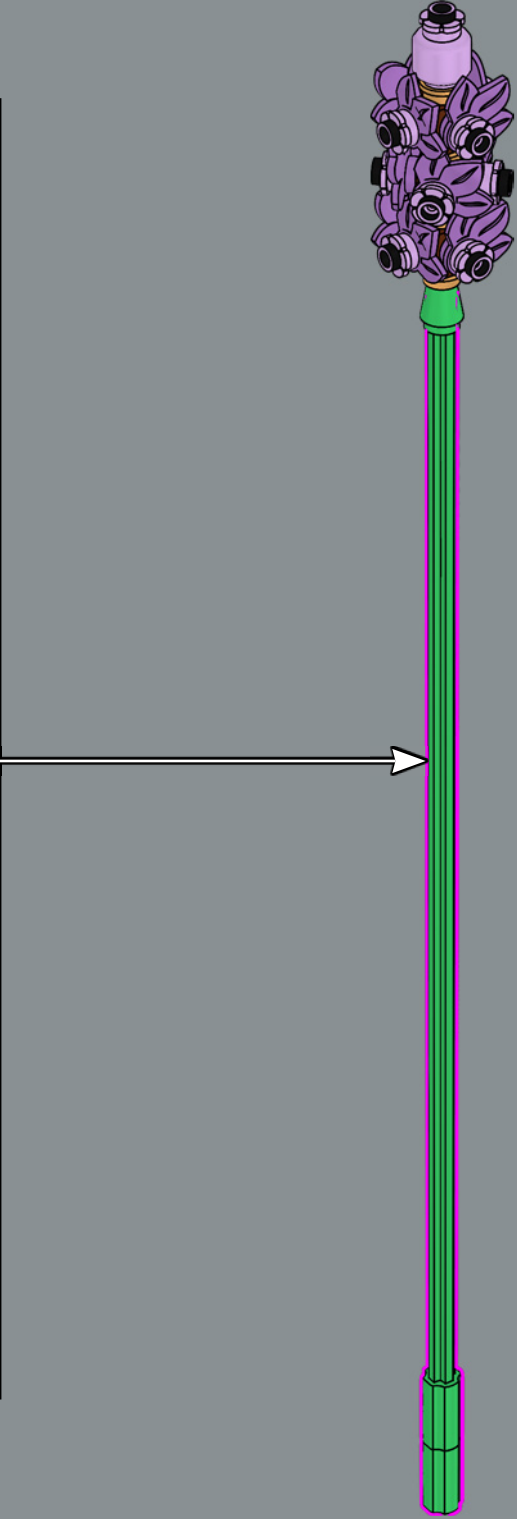
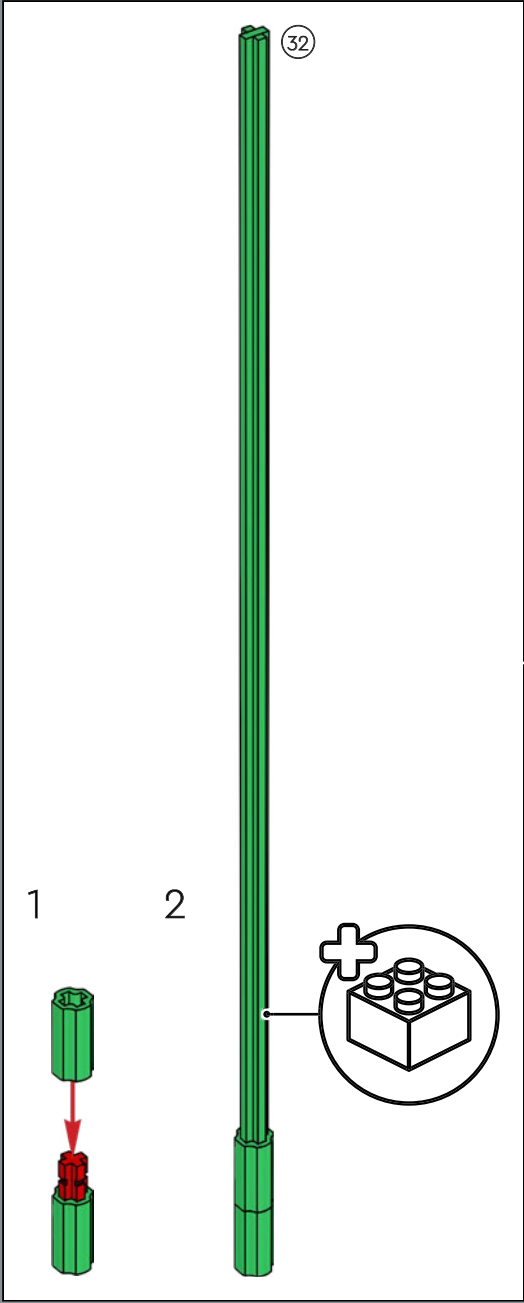

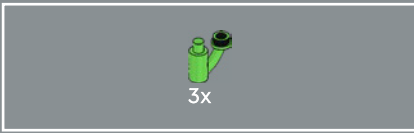
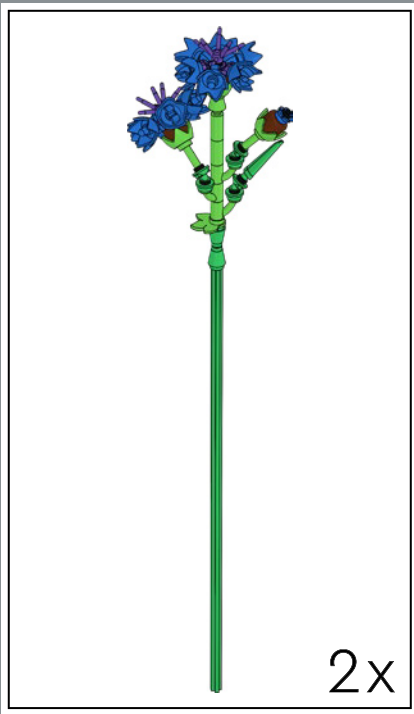

1

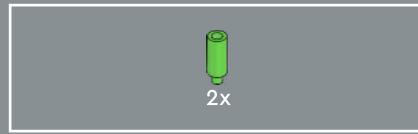

2

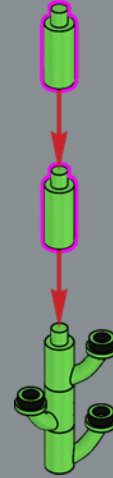

3

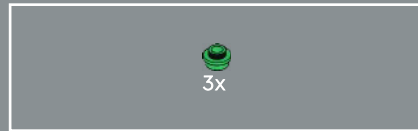
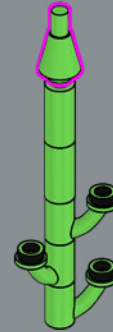

4

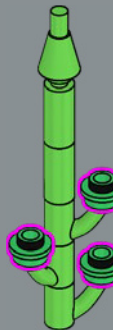

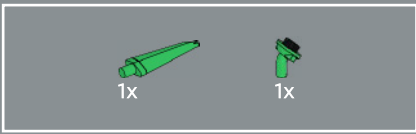

5

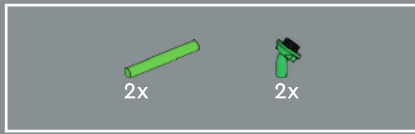
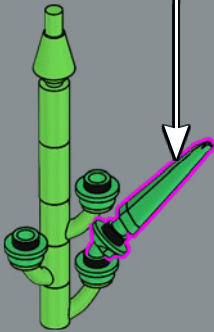
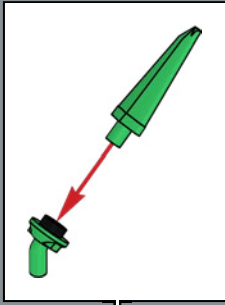

6

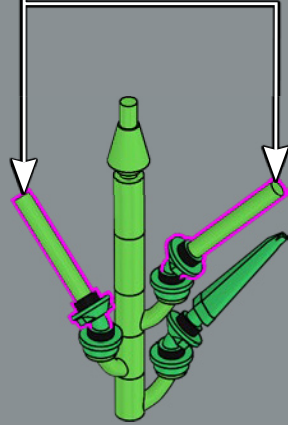
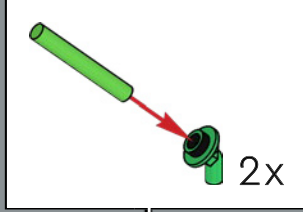

7

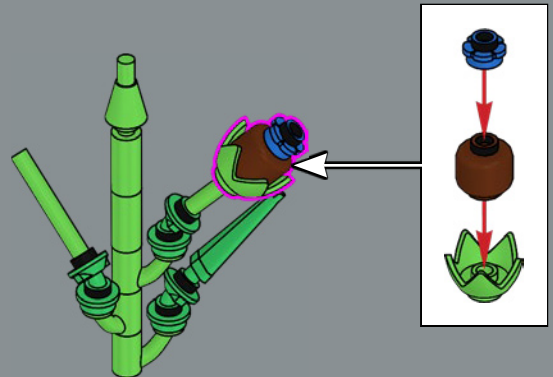

The LEGO Group is working to build a more sustainable future for children. Currently more than 80 LEGO® elements including trees, leaves and bushes are made from a plant-based plastic, produced using sustainably sourced sugarcane, Plants from Plants! These elements represent the first steps of a bigger mission to make LEGO bricks from sustainable sources by 2030.

Le Groupe LEGO s'emploie à bâtir un avenir plus durable pour les enfants. À l'heure actuelle, plus de 80 éléments LEGO®, dont des arbres, des feuilles et des buissons, sont fabriqués à partir de plastique végétal fait à base de canne à sucre de sources durables. Des plantes fabriquées avec des plantes ! Ces éléments constituent la première étape d'une mission bien plus considérable visant à fabriquer des briques LEGO issues de sources durables d'ici 2030.

The LEGO Group está trabajando en la construcción de un futuro más sustentable para los niños. En la actualidad, más de 80 elementos LEGO® (como árboles, hojas y arbustos) se fabrican a partir de plástico de origen vegetal producido con caña de azúcar procedente de fuentes sustentables, lo que da nombre a nuestra iniciativa: Plantas con Plantas. Estos elementos representan los primeros pasos de una misión de mayor envergadura cuyo objetivo es que los bricks LEGO se fabriquen a partir de fuentes sustentables antes de 2030.

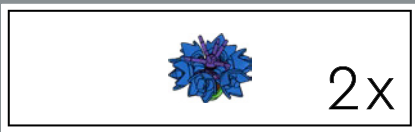

8



9

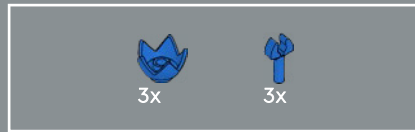

10

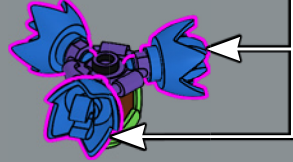
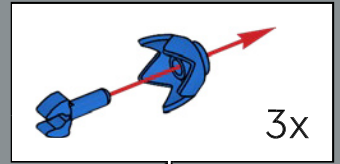

11

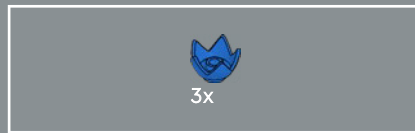
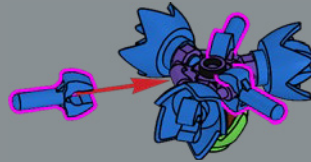

12

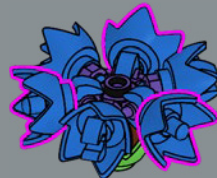



13

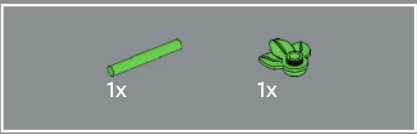
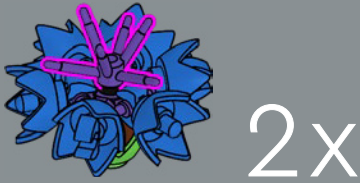

15

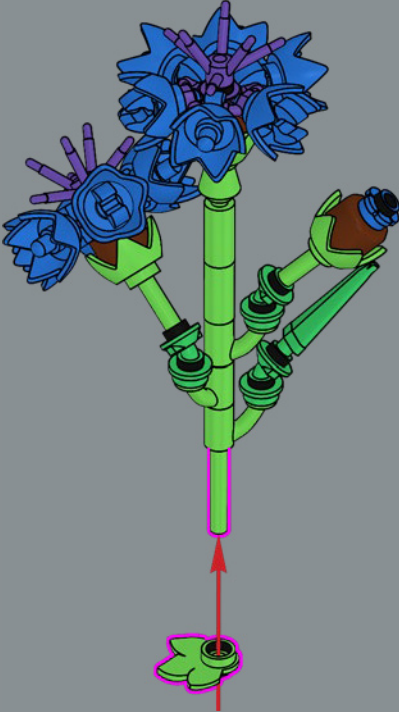

14

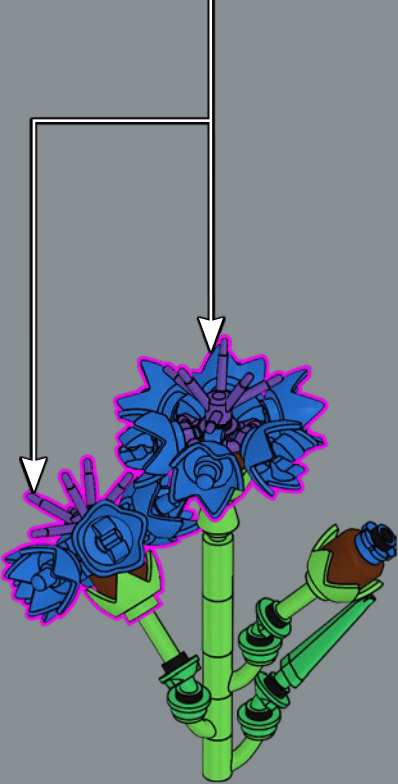

16

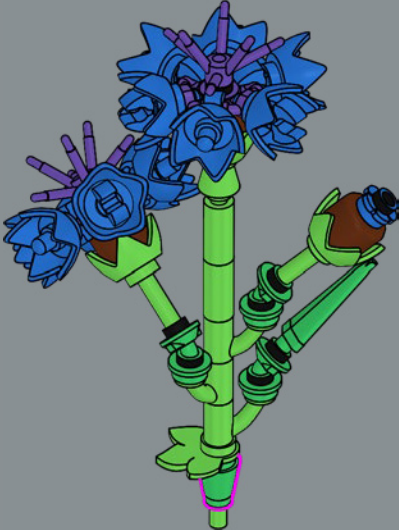



17

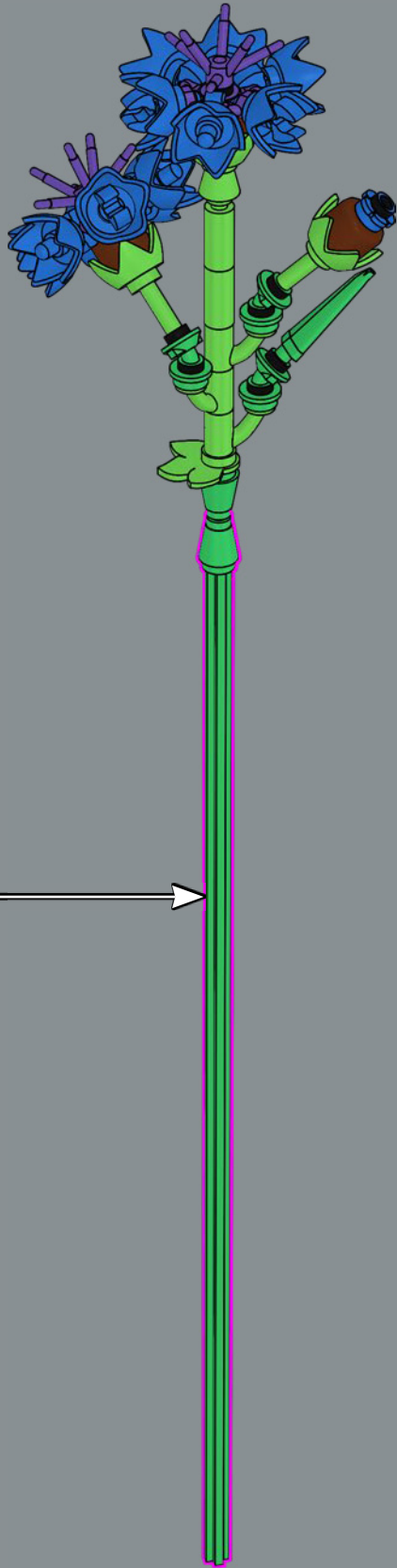
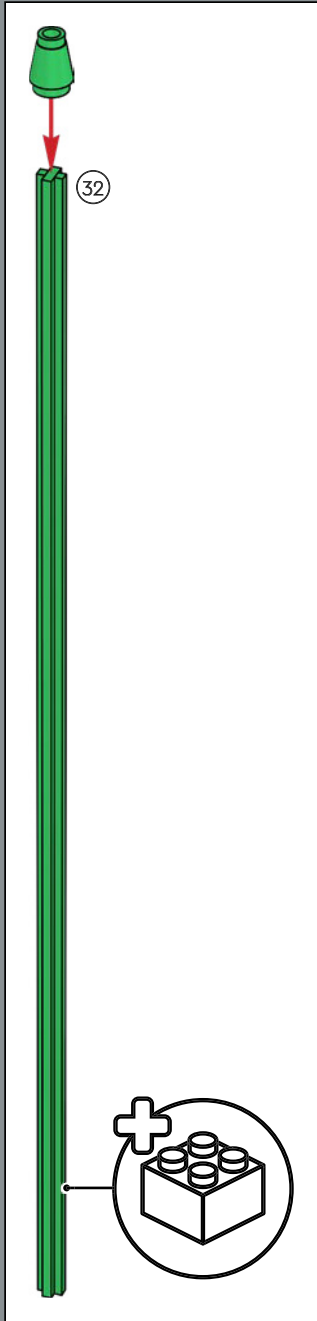



LUPIN
BULLO ETOFFIC
ALTRAMUZ

(Lupinus)

✿ Originally native to North America, Lupins also thrive in the wild in the Mediterranean and Europe. Wildly diverse in color, their ombred spikes climb tall to attract pollinators' attention – and ours – across the North American prairie, along roads and in gardens all over the world.

✿ Originaire d'Amérique du Nord, le lupin prospère également à l'état sauvage en Méditerranée et en Europe. De couleurs très variées, ses pointes dégradées poussent en hauteur pour attirer l'attention des pollinisateurs (et la nôtre) dans les prairies d'Amérique du Nord, le long des routes et dans les jardins du monde entier.

✿ Originarios de Norteamérica, los altramuces son capaces de vivir en estado salvaje también en Europa y alrededor del Mediterráneo. Sus iridiscentes puntas se alzan para atraer la atención de los polinizadores (y la nuestra) a lo largo y ancho de las praderas de Norteamérica, al lado de las carreteras y en jardines de todo el mundo.

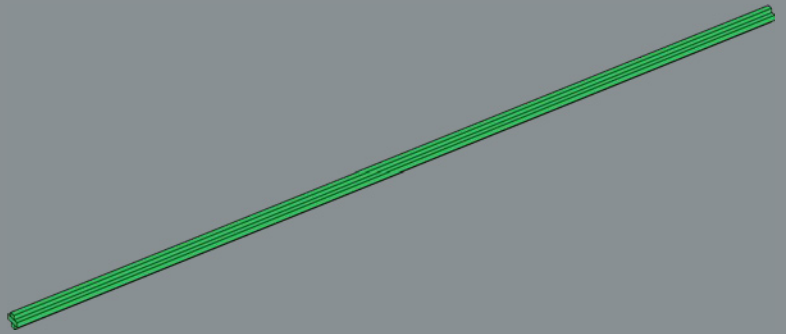
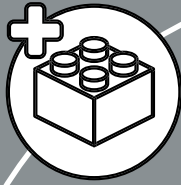

2x



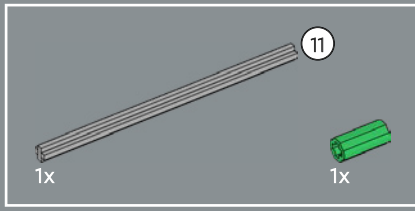
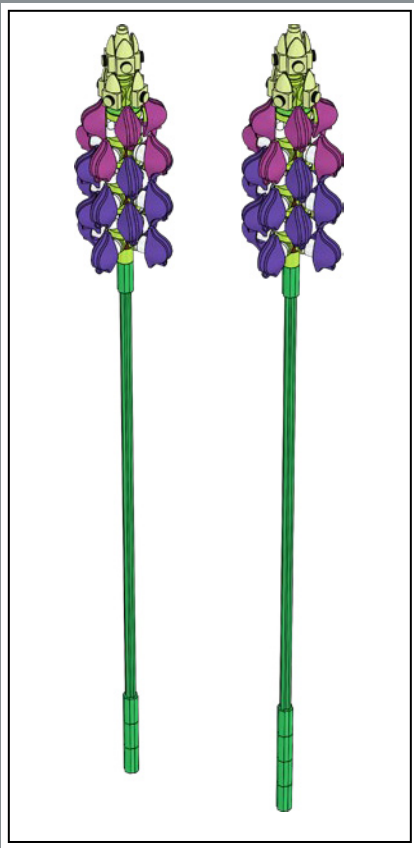

1

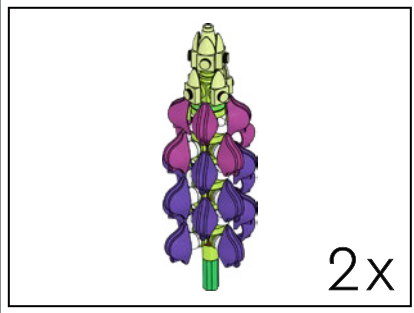
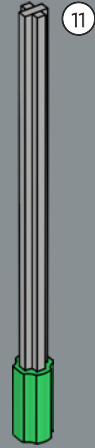

2

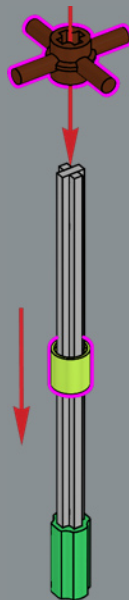



3

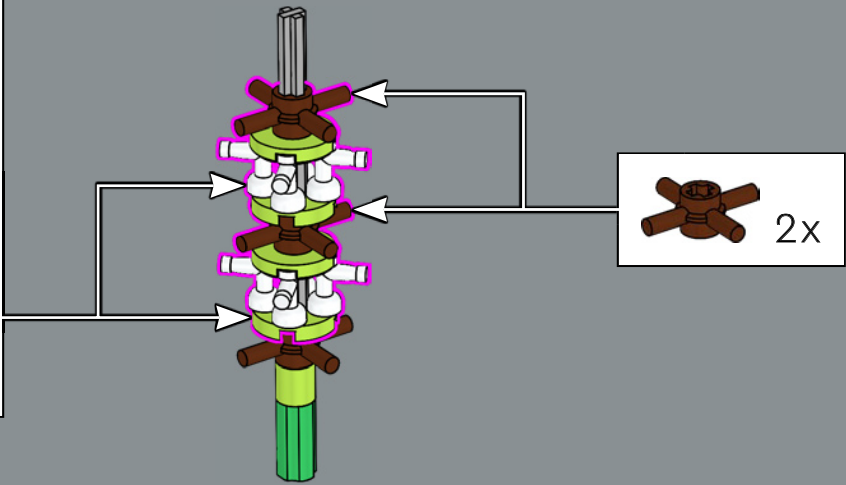
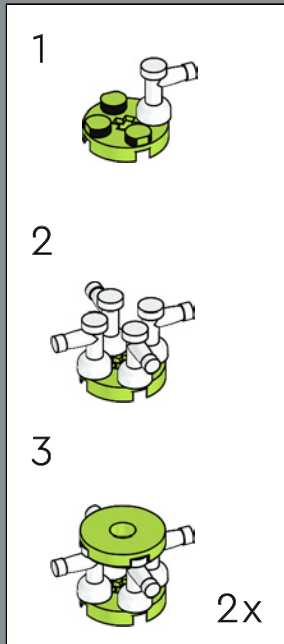

4

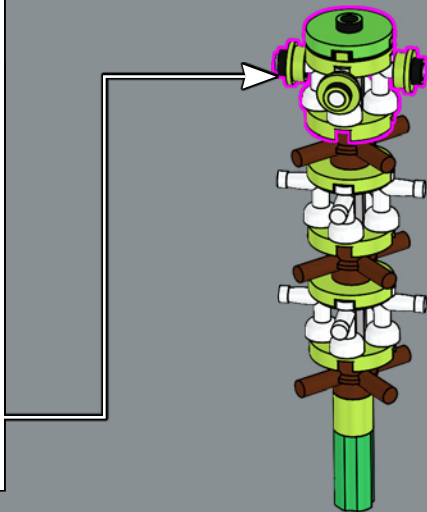
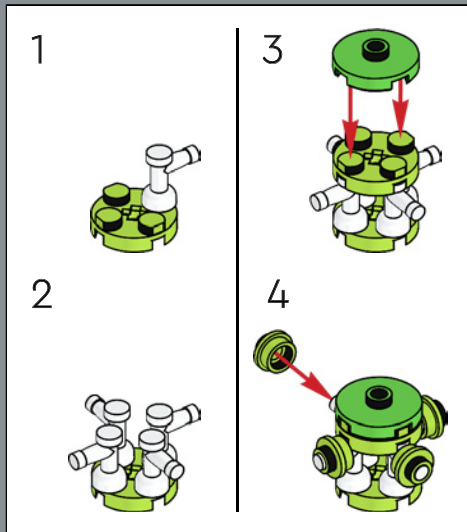

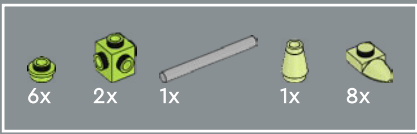

5

1



2

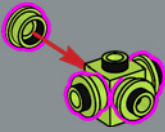

3

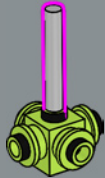

4

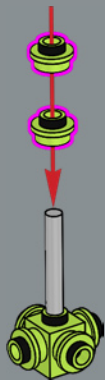

5



6



7

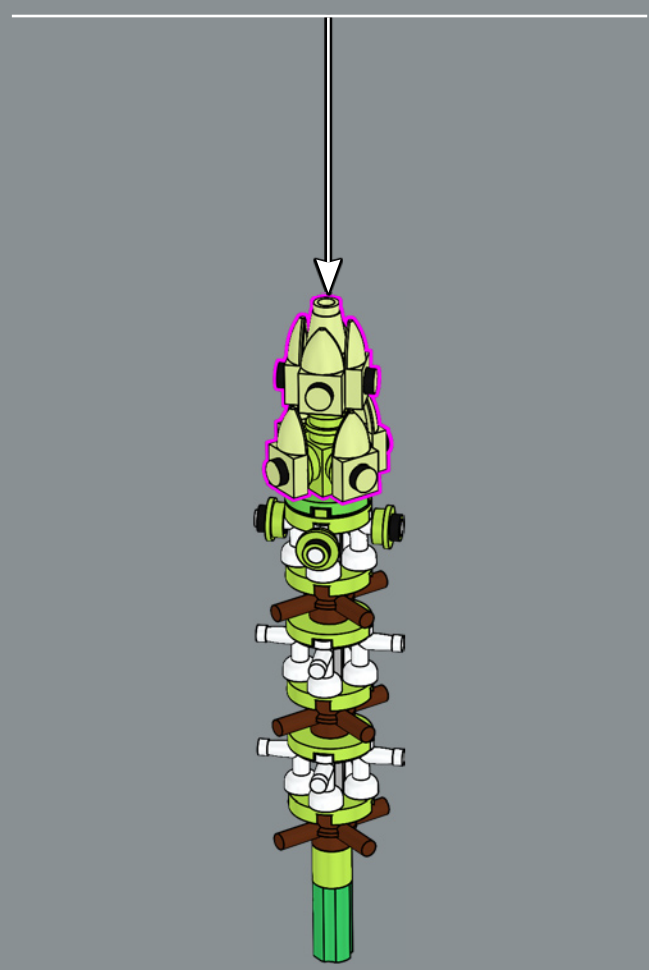



6

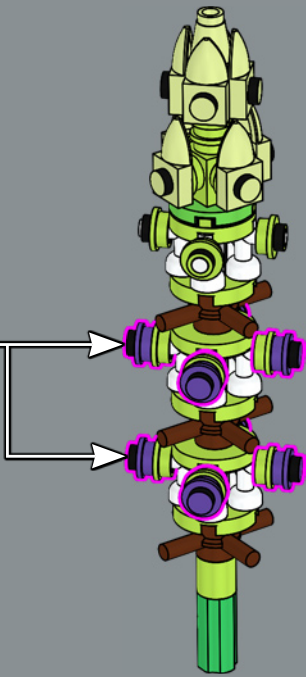
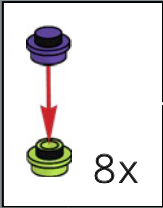

8

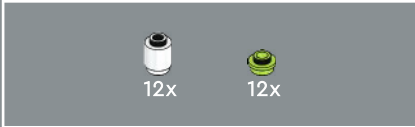
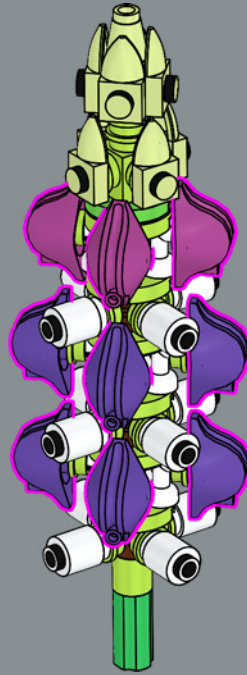

7

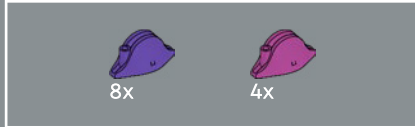
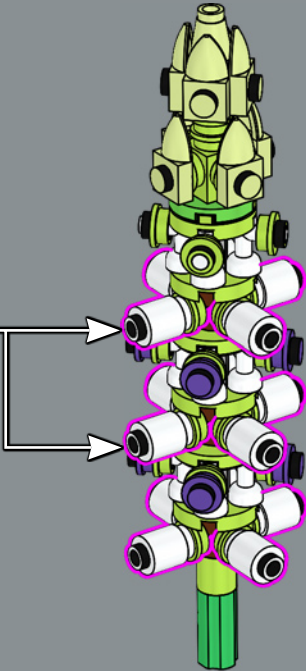
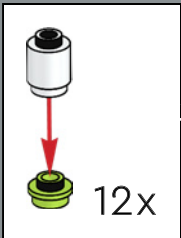

9

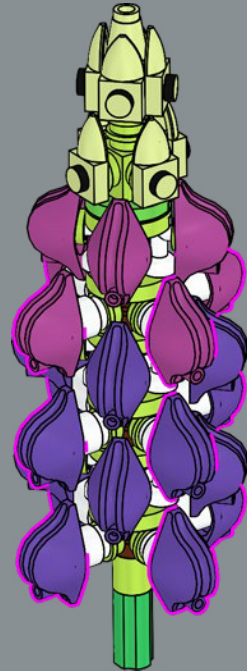

2x

10



The minifigures who wore these pirate hats back in 1989 could never have imagined that their fancy headgear would one day be used as Lupin petals!

Les figurines qui portaient ces chapeaux de pirates en 1989 n'auraient jamais pu imaginer que leurs élégants couvre-chefs seraient un jour utilisés comme pétales de lupin !

¡Las minifiguras que llevaban puestos estos sombreros de pirata en 1989 jamás habrían imaginado que sus elegantes tocados se usarían como pétalos de altramuces!

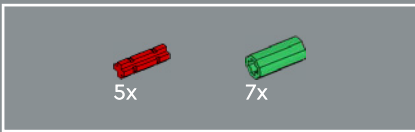

11

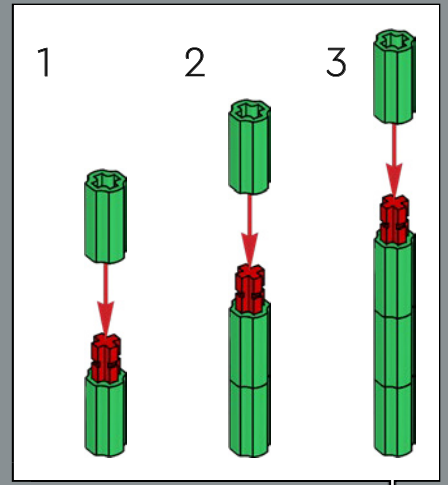
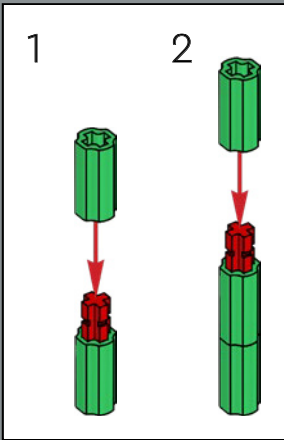



LARKSPUR DAUPHINELLE CULTIVÉE ESPUELA DE GALÁN

(*Consolida ajacis*)

✿ The Larkspur gifts us eye-catching wildflower seas in blooming hues of blues across fields and gardens throughout the Northern Hemisphere. An annual species, it arrives in early spring and, along with its close relative the perennial *Delphinium*, adds height and an airy, elegant pop of color to your bouquet.

✿ La dauphinelle cultivée nous offre des mers de fleurs sauvages bleues spectaculaires dans les champs et les jardins de l'hémisphère nord. Espèce annuelle, elle arrive au début du printemps et, tout comme ses proches parents vivaces du genre *Delphinium*, elle ajoute de la hauteur et une touche de couleur légère et élégante à votre bouquet.

✿ La espuela de galán nos regala vistosos mares de flores silvestres en un amplísimo espectro de tonalidades azules que se apoderan de prados y jardines de todo el hemisferio norte. Su ciclo anual comienza a inicios de la primavera y, al igual que sus parientes cercanos de hoja perenne del género *Delphinium*, aportan altura y un vaporoso y elegante toque de color a tu ramo.

GERBERA DAISY MARGUERITE DU TRANSVAAL GERBERA

(*Gerbera jamesonii*)

✿ A cousin to the sunflower, the lustrous Gerbera comes in a rainbow of color variations. Native to South Africa, it is also known as the African daisy, Transvaal daisy, or Hilton daisy. With its soft scent and majestic, elevated crown brimmed with velvet-like petals, it radiates light in any garden, field or bouquet.

✿ Cousine du tournesol, la brillante marguerite du Transvaal se décline en un arc-en-ciel de couleurs. Originnaire d'Afrique du Sud, elle est également connue sous le nom de marguerite de Barberton. Avec son doux parfum et sa majestueuse couronne surélevée bordée de pétales veloutés, elle illumine n'importe quel jardin, champ ou bouquet.

✿ Prima del girasol, la lustrosa gerbera viene en tonalidades tan variadas como las del arcoíris. Originaria del sur de África, también se la conoce como *margarita africana* o *margarita de Transvaal*. Con su suave aroma y una majestuosa corona elevada bordeada por pétalos suaves como el terciopelo, es capaz de llenar de luz cualquier jardín, prado o ramo.

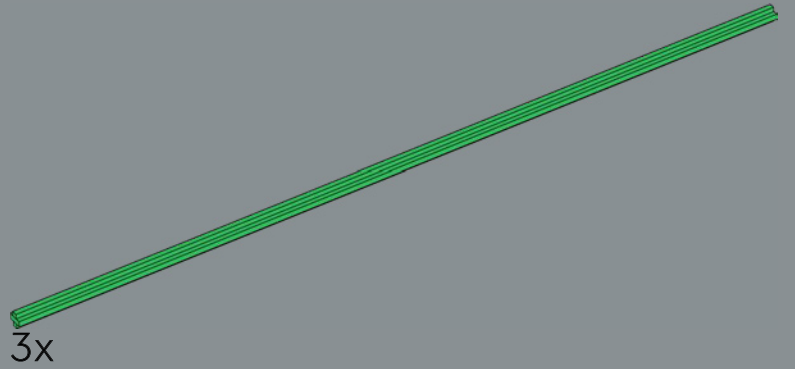
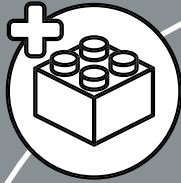

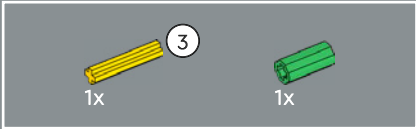
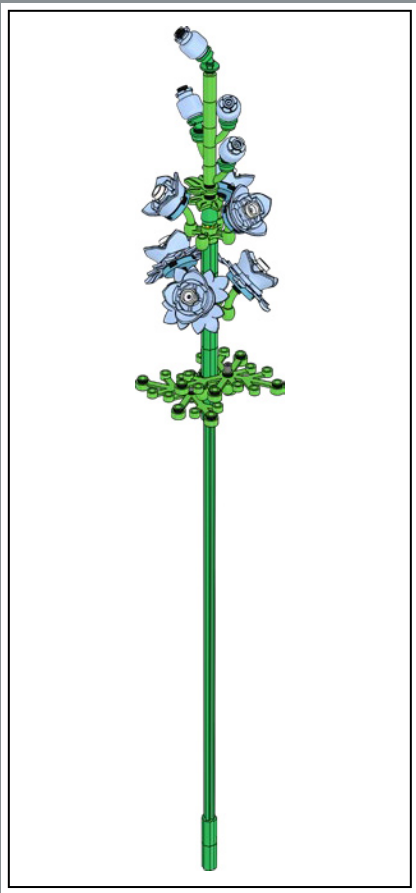

1

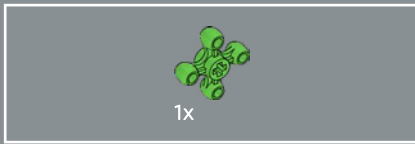
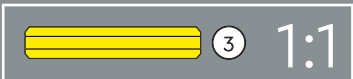
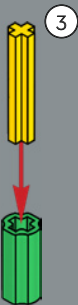

2

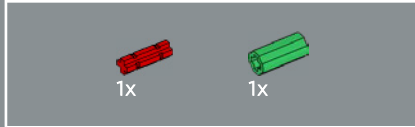
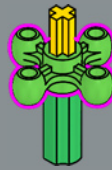

3

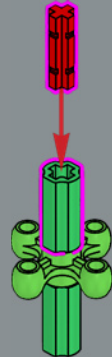

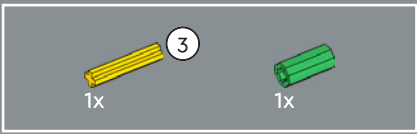

4

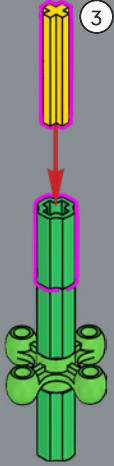

5

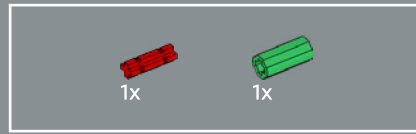
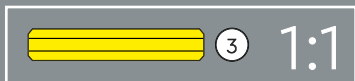
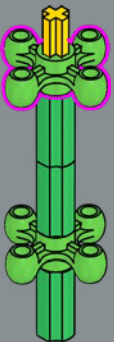

6

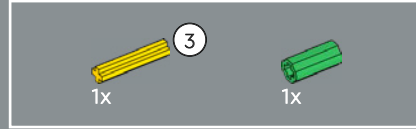
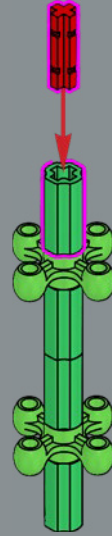

7

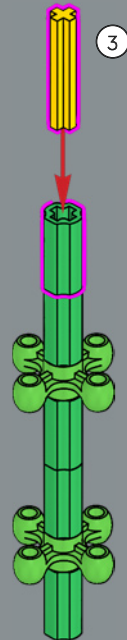



8

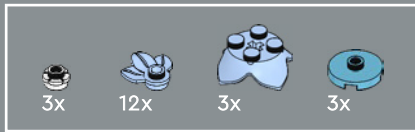
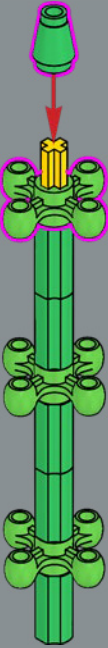

10

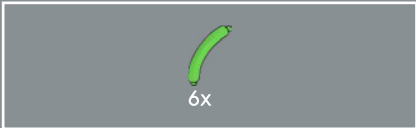
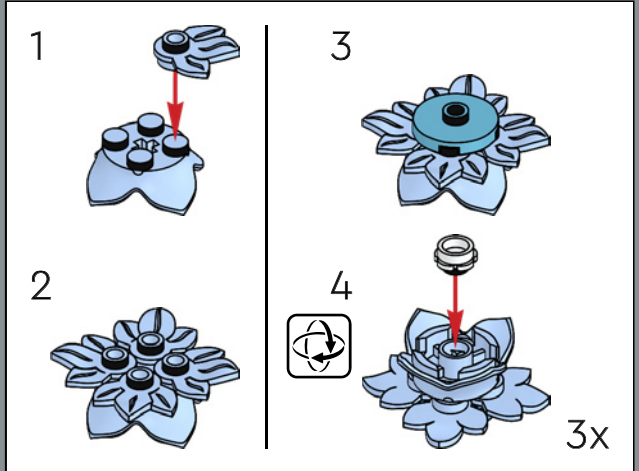

9

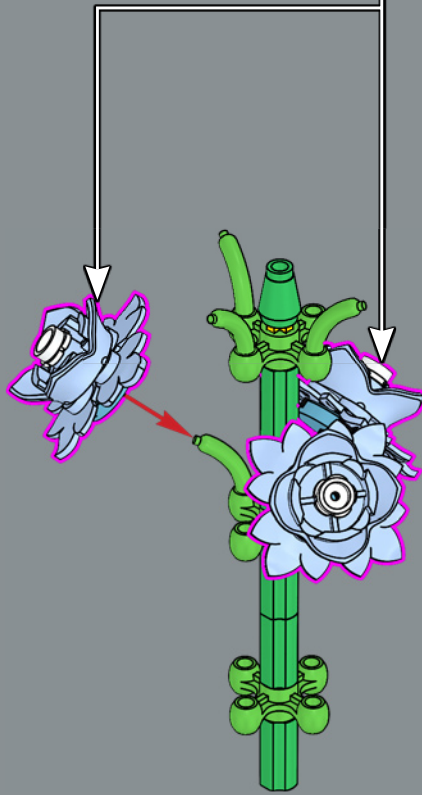
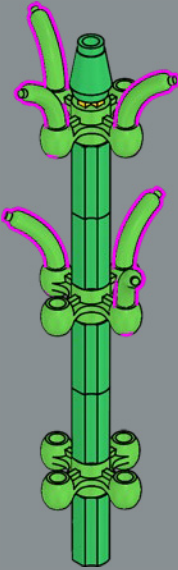



11

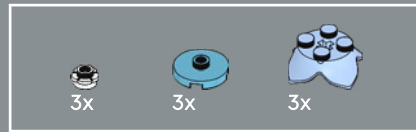
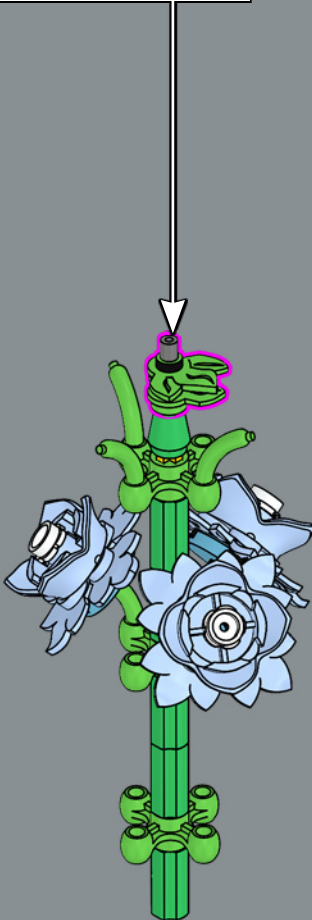
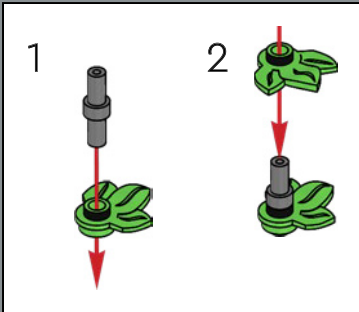

12

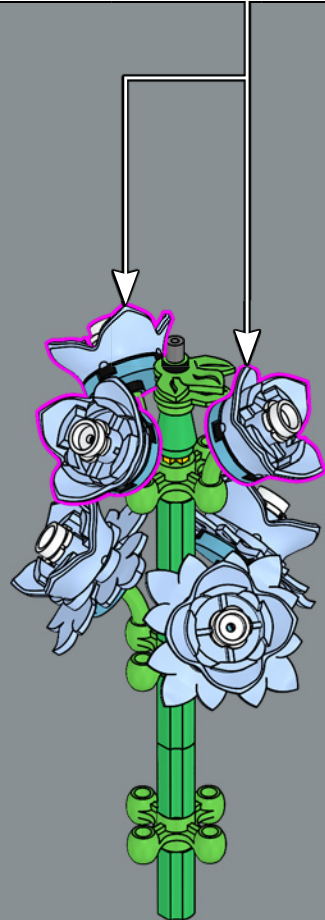
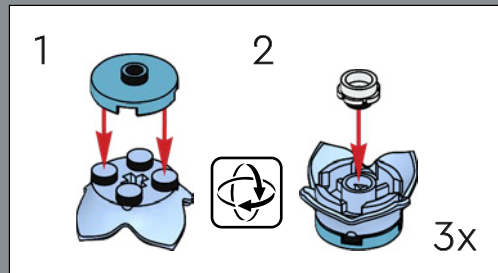

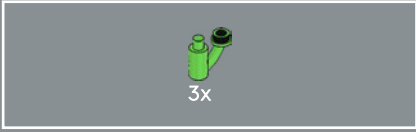
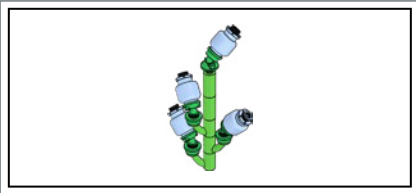

13



14

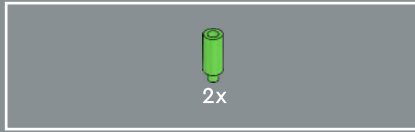
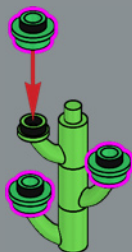

15

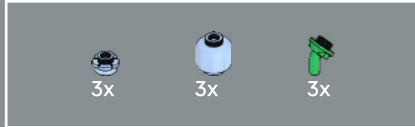
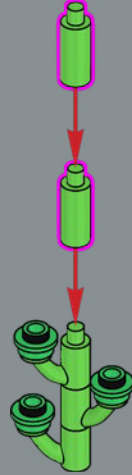

16

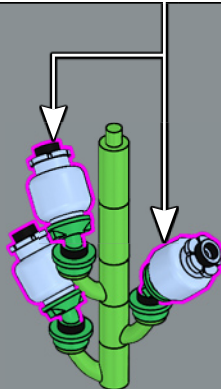
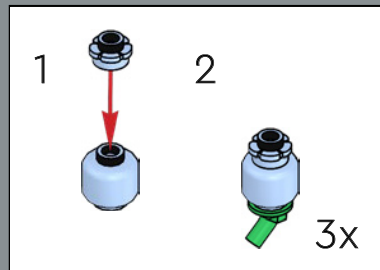



17

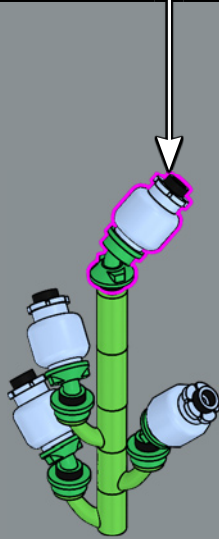
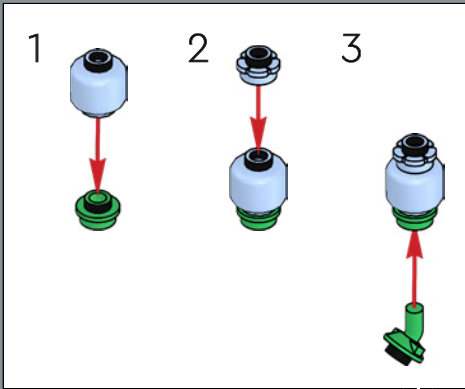

18

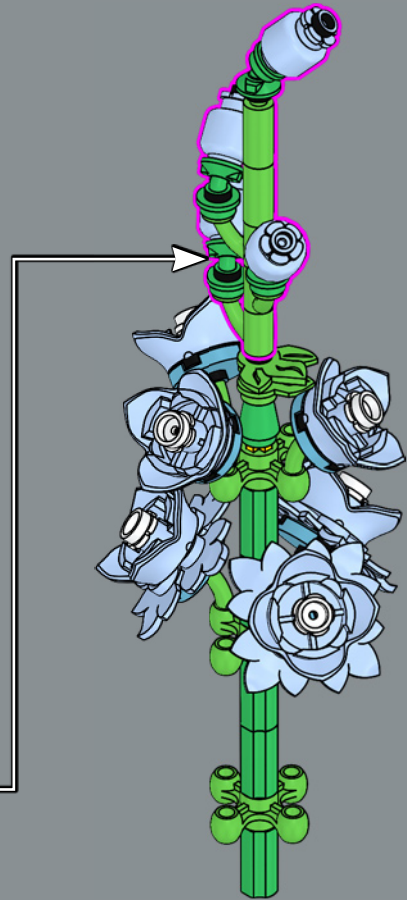

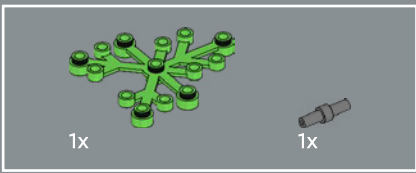

19

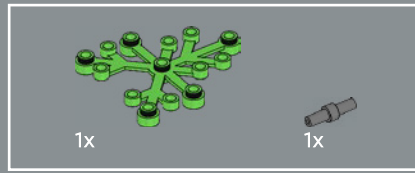
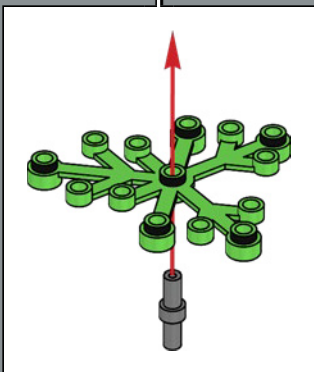
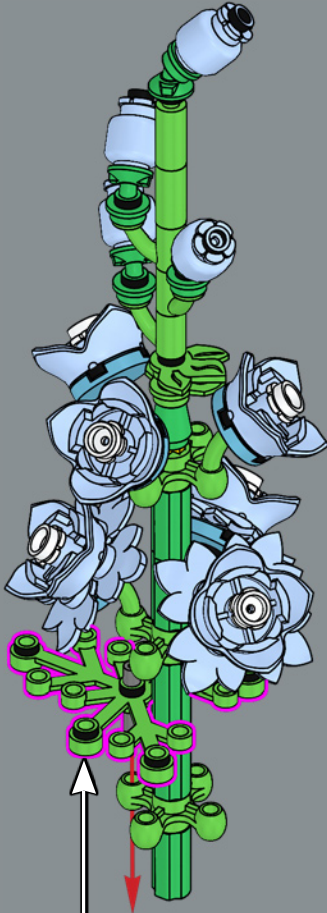

20

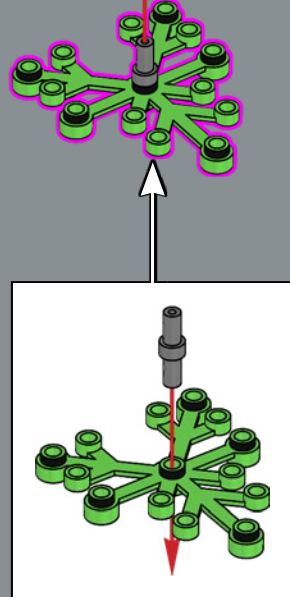
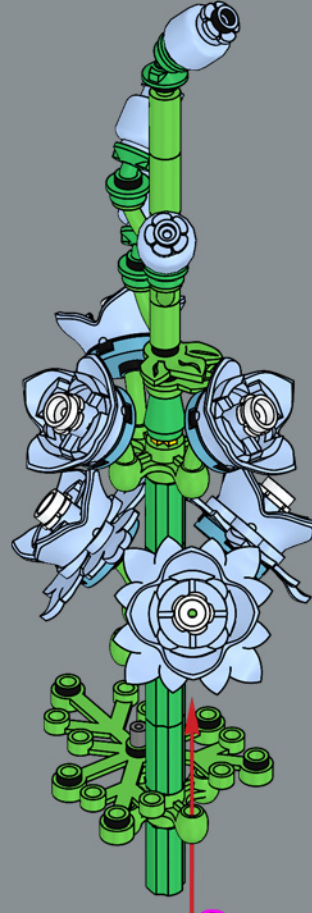

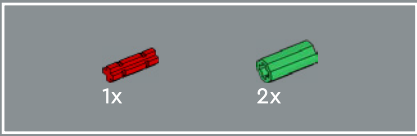

21

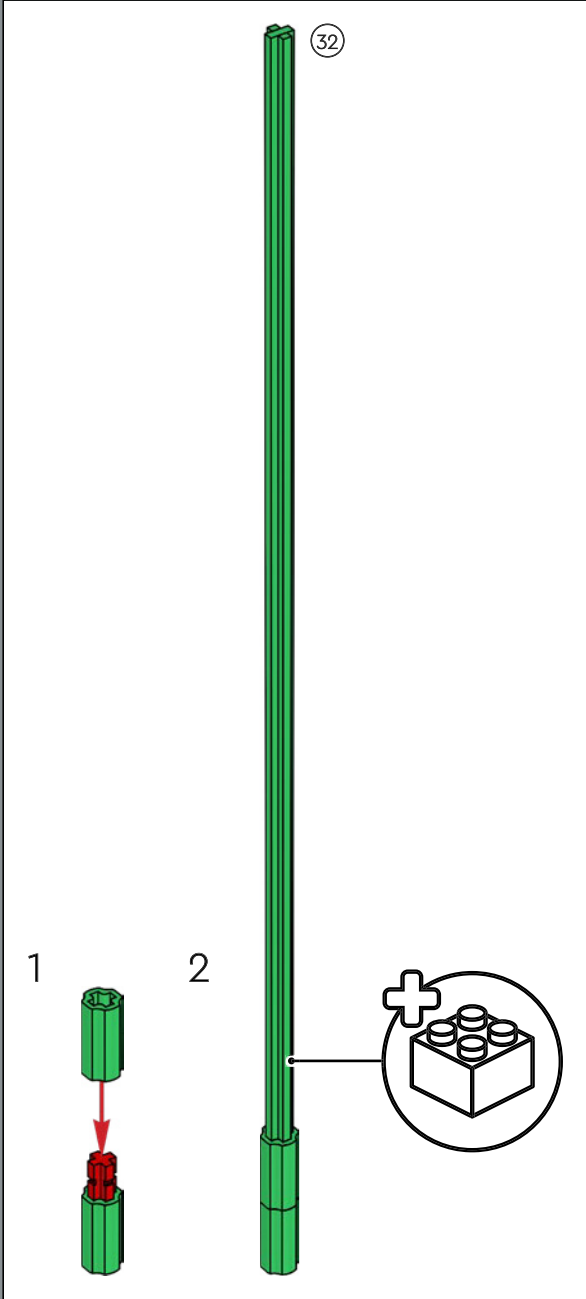
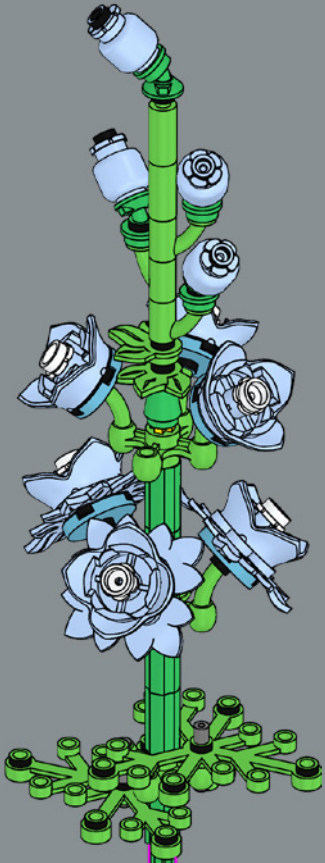

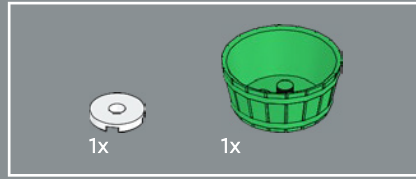
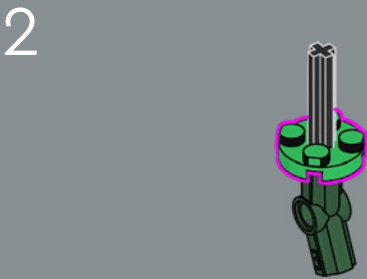
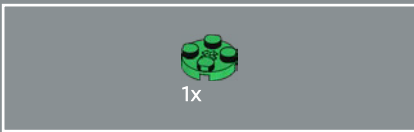
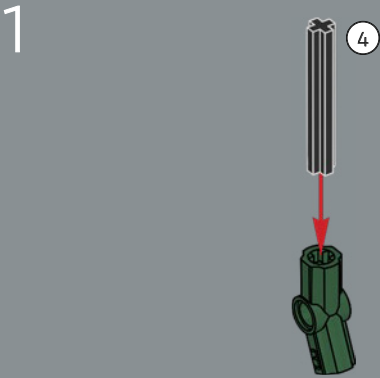
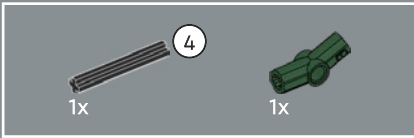

3

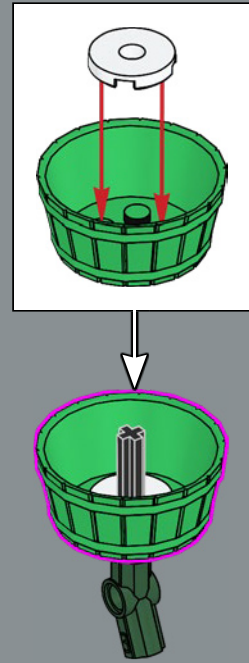

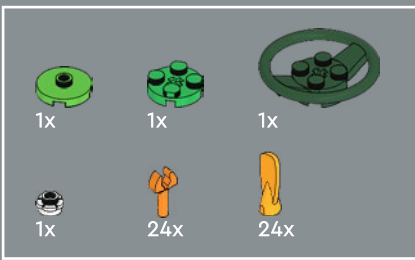

4

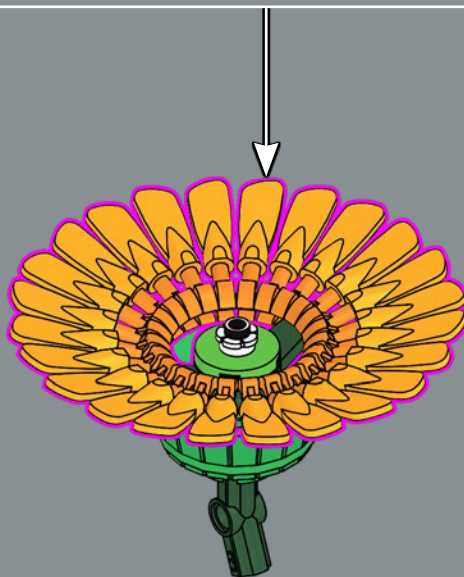
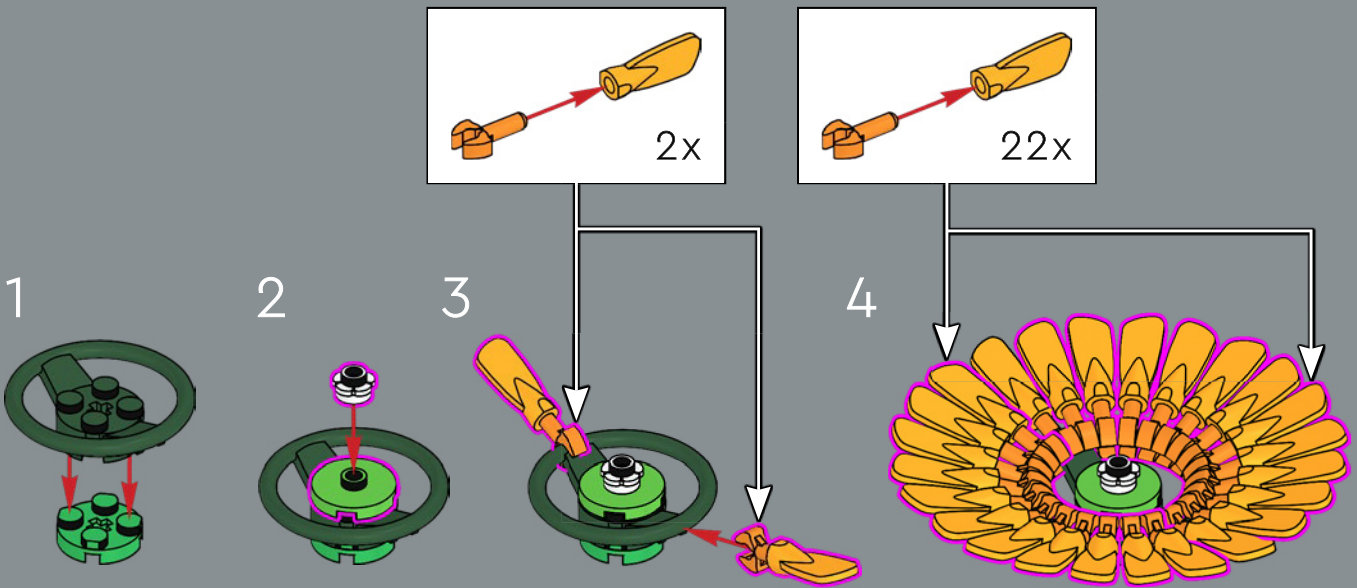

These delicate little petals are actually minifigure oars!

Ces délicats petits pétales sont en fait des rames de figurines !

¡Estos pequeños y delicados pétalos son en realidad remos para minifiguras!



5



6

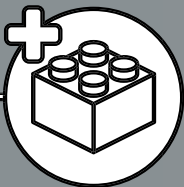

32



First introduced in 1983 as part of the LEGO® Fabuland theme, this bucket has been used in everything from rocket engines to flower receptacles.

Présenté pour la première fois en 1983 dans le cadre du thème LEGO® Fabuland, ce seau a été utilisé dans tout, des moteurs de fusée aux réceptacles de fleurs.

Introducida originalmente en 1983 como parte del tema LEGO® Fabuland, esta cubeta se ha utilizado en todo tipo de cosas, desde motores de cohetes hasta recipientes para flores.

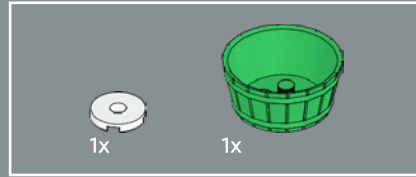
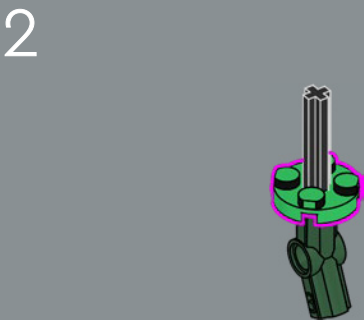
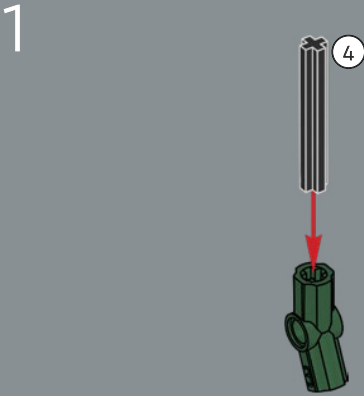
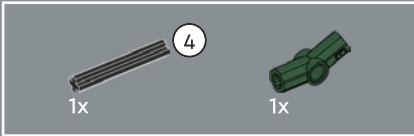

3

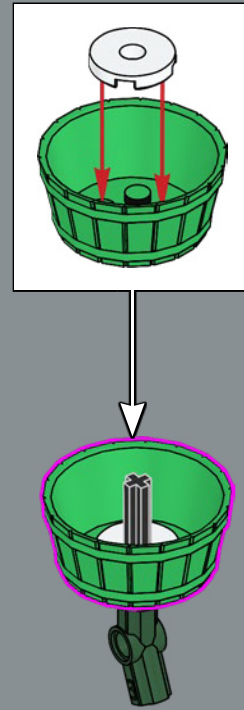

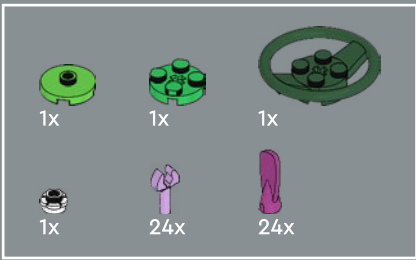

4

1

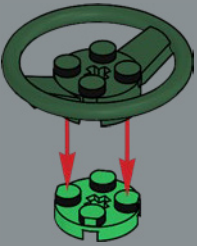

2

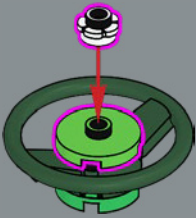

3

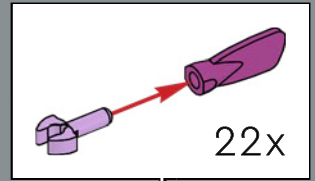
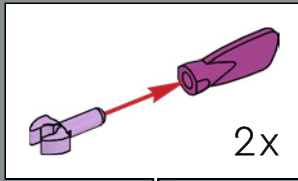
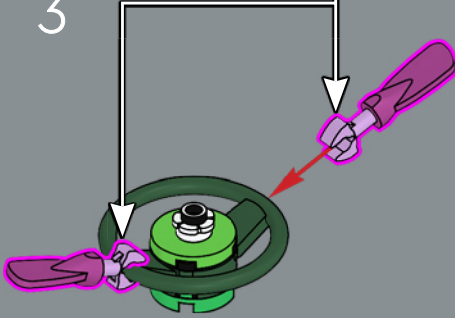

4

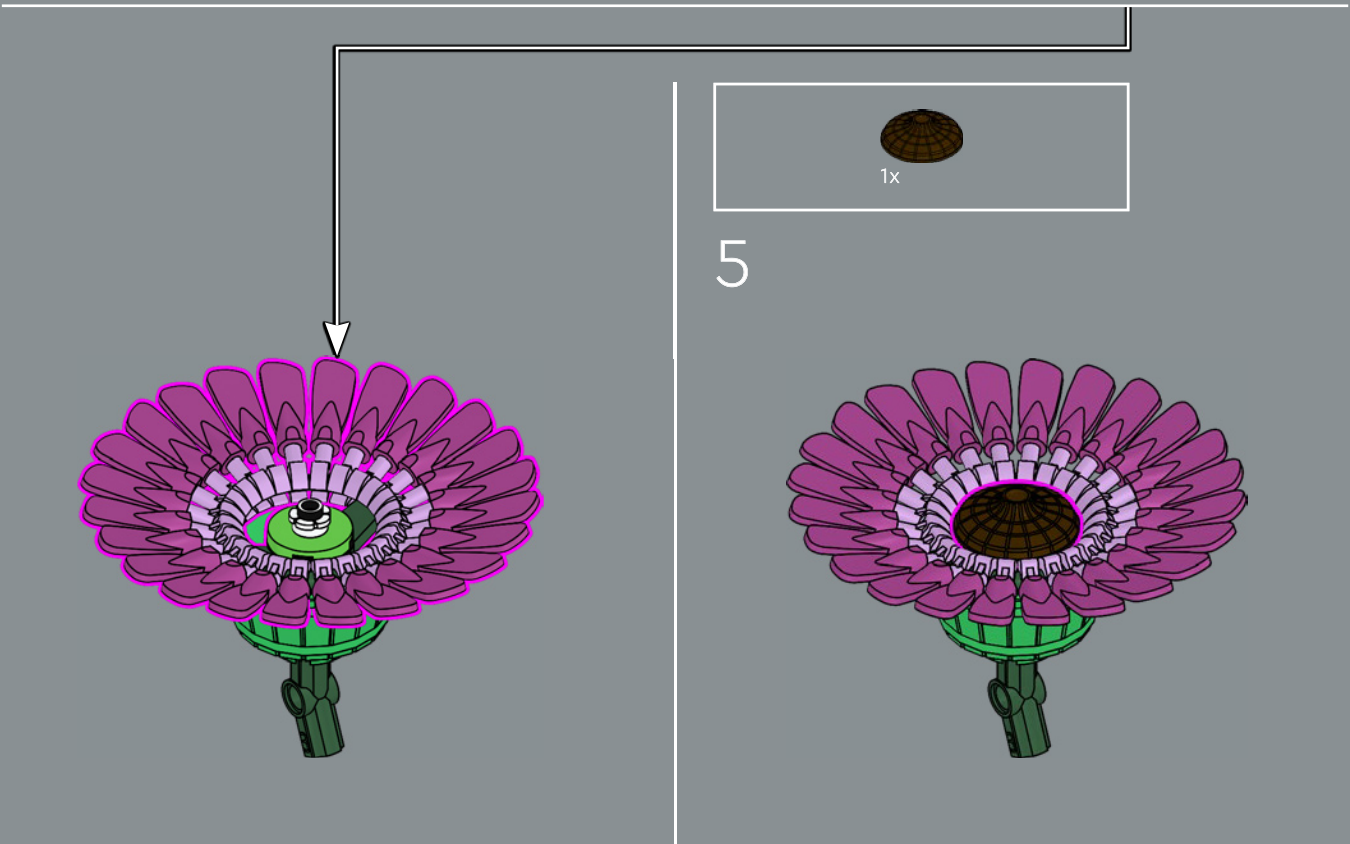

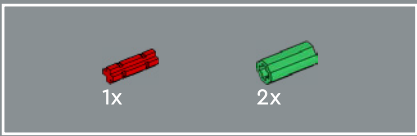

6

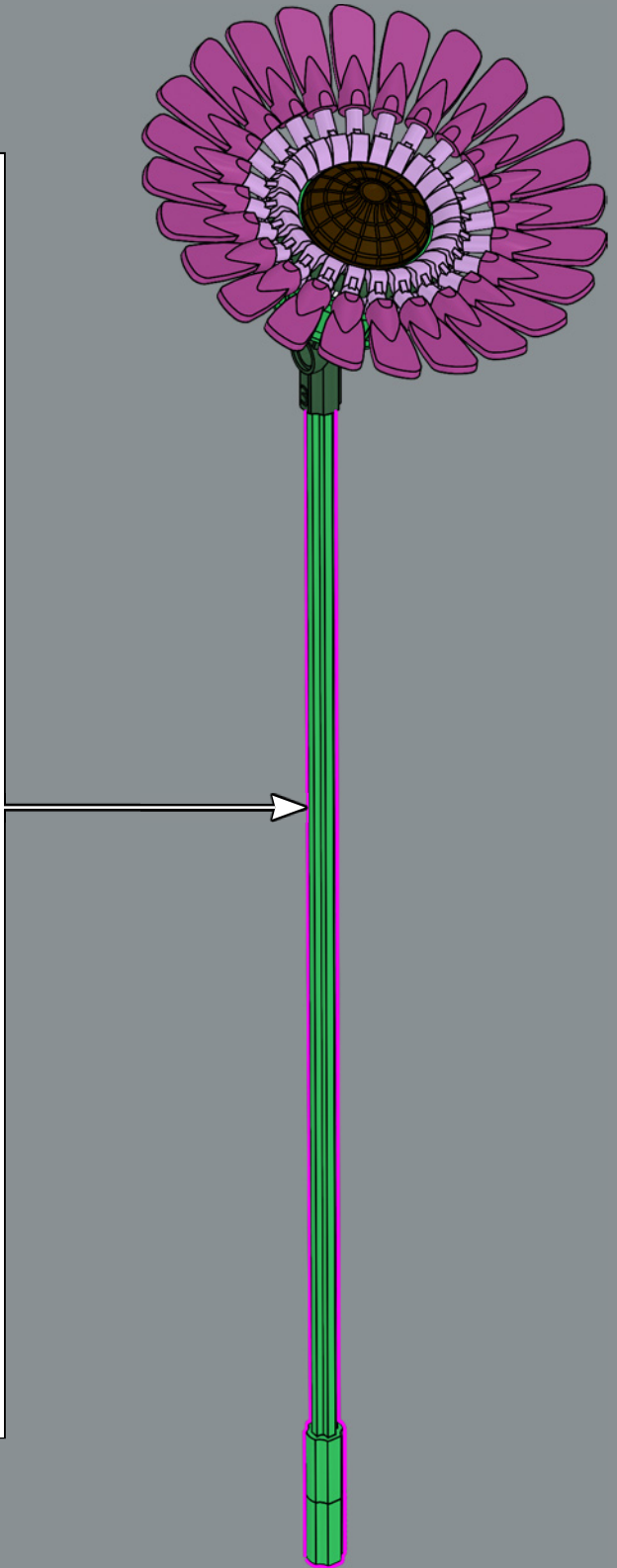
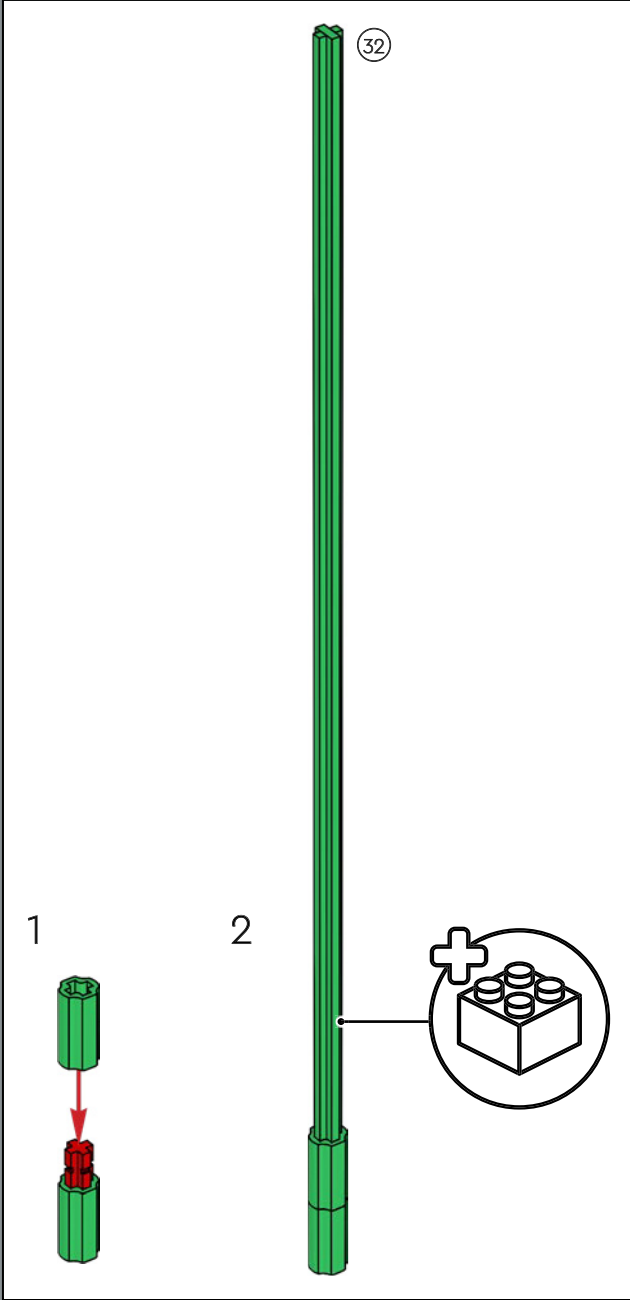

24x
306201

2x
6310185

24x
459901

68x
6206149

2x
6170419

2x
6194512

6x
6259700

6x
6339183

16x
6348056

2x
4515349

8x
6420923

13x
6130007

61x
4142865

3x
6055225

15x
6420219

2x
6329283

8x
6344177

24x
6330196

2x
6329274

24x
6424588

6x
6133765

7x
4211218

12x
6316697

2x
6382540

24x
6420229

24x
6420230

3x
6350724

2x
6116608

2x
6178172

4x
6209683

12x
6420914

6x
6420921

4x
6294900

2x
6420922

16x
4566522

5x
6420217

32x
6420916

5x
6420218

8x
6190252

2x
6416732

6x
6136419

24x
6210460

26x
6214235

2x
6329317

24x
6420920

4x
6420918

16x
6267420

11x
4529239

11x
6338221

8x
6210271

8x
403228

2x
6420221

2x
6266964

20x
6269971

11x
6382575

3x
6270084

50x
6374076

2x
6420635

12x
6420964

4x
6380676

10x
6388070

5x
6182261

2x
6345196

7x
6161772

7x
6328327

7x
6420228

3x
6331087

6x
6430093

3x
6420915

1x
6254100

24x
6278159

4x
6174006

2x
6302741

60x
6190251

10x
6314224

4x
6167483

16x
6420919

24x
6420220

3x
6267045

3x
6265699

2x
370526

32



LEGO.com/service



MIX YOUR BOUQUET
COMPOSEZ VOTRE BOUQUET
COMBINA TU RAMO



🌸 Your Wildflower Bouquet is designed to look beautiful in mixed bouquets, too. Find inspiration to build creative combinations with the 10280 Flower Bouquet set.

🌸 Votre bouquet de fleurs sauvages est conçu pour être également magnifique dans les bouquets mixtes. Créez des combinaisons uniques en vous inspirant de l'ensemble 10280 Le bouquet de fleurs.

🌸 Tu Ramo de Flores Silvestres está diseñado para verse hermoso también en combinación con otros ramos. Encuentra ideas para construir composiciones creativas con el set Ramo de Flores (10280).

