

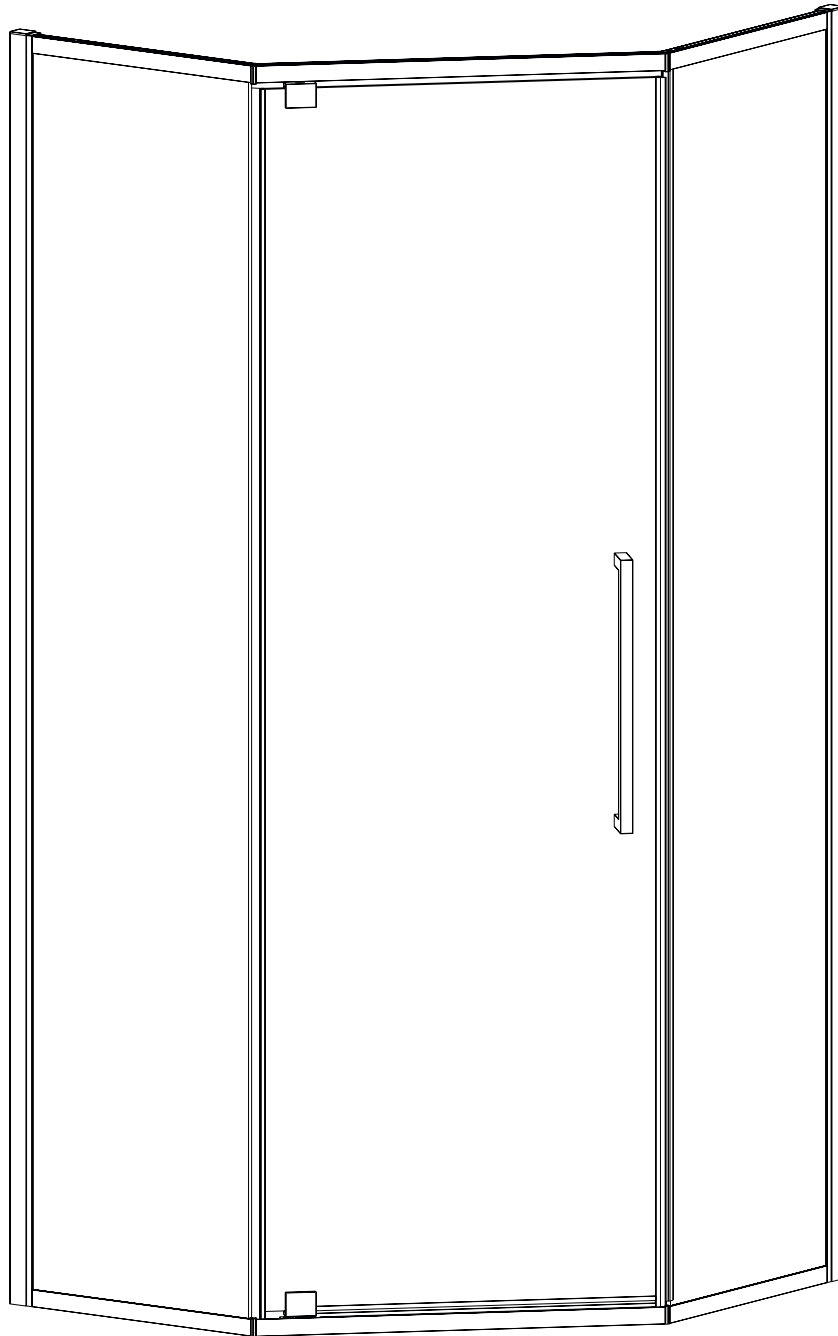

Душевой угол

**RV-35/35B**



Инструкция по установке

Пожалуйста, прочитайте инструкцию перед установкой

 Перед установкой поддон для душа должен быть выставлен по уровню и полностью герметичным к плитке.

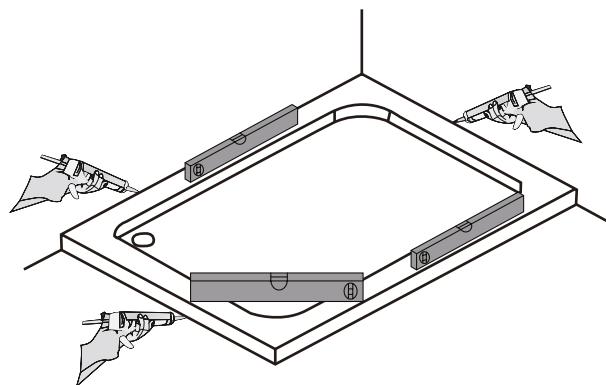

Необходимые инструменты и оборудование



Карандаш

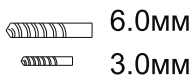

Сверло



Отвертка

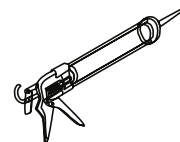

Силикон

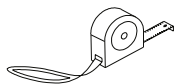

Рулетка

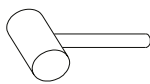

Молоток



Уровень



Дрель

Данная модель с универсальной установкой открывания двери

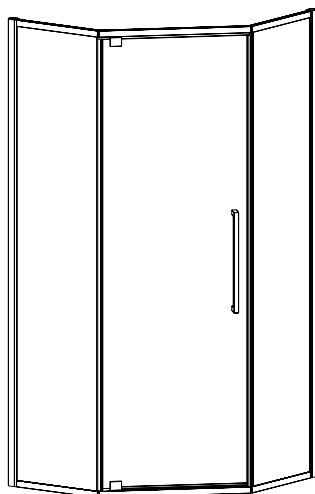

Левая ориентация

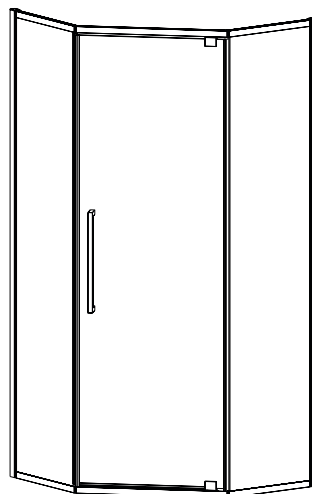

Правая ориентация

## Общий вид душевого угла

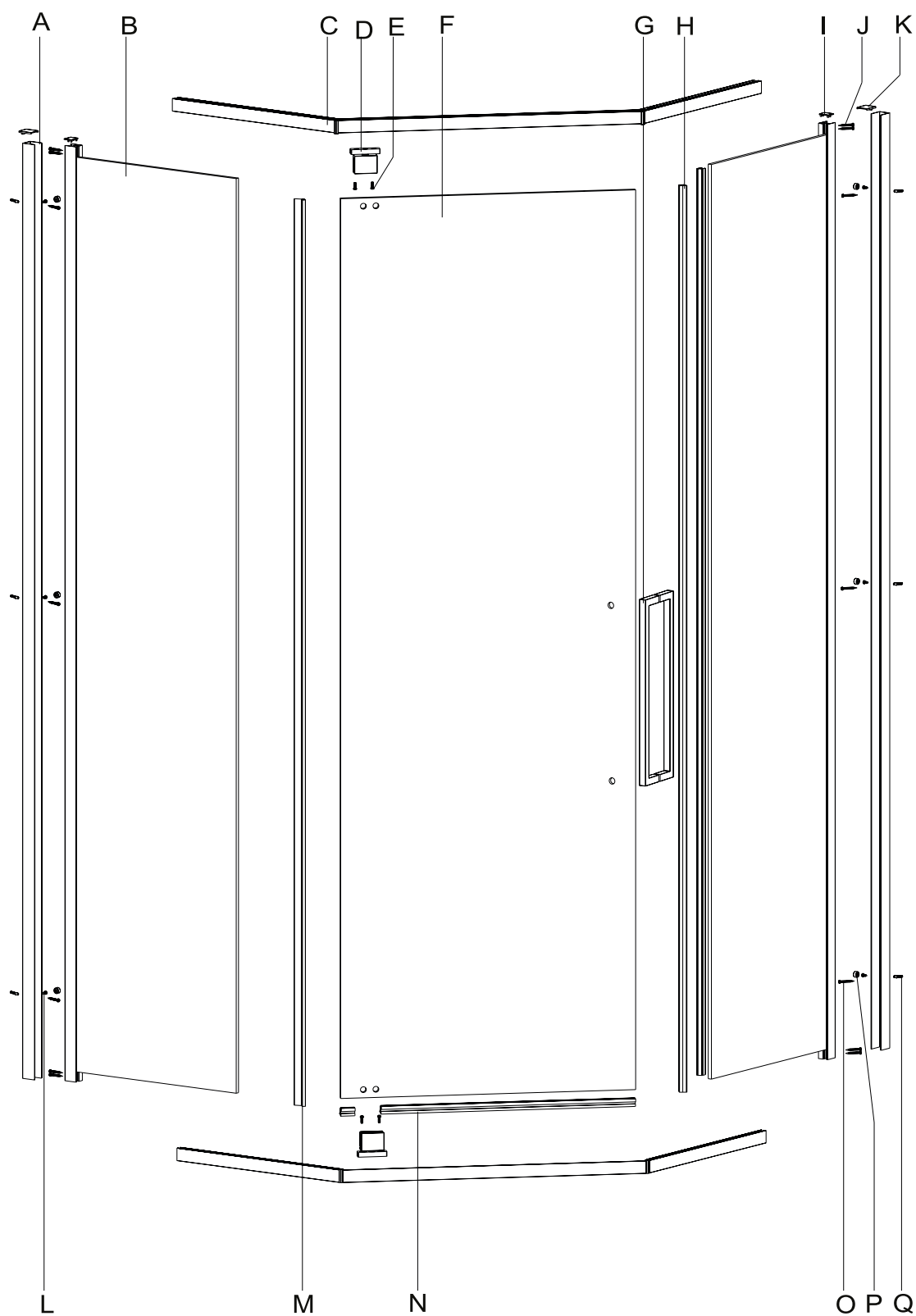

## Перечень деталей

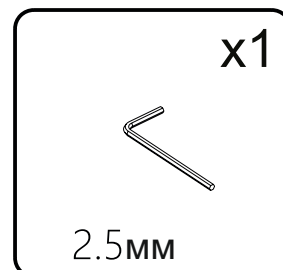
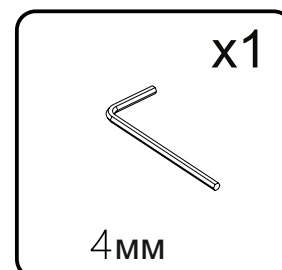
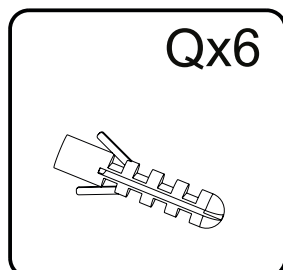
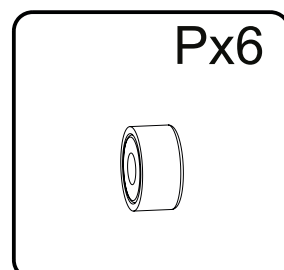
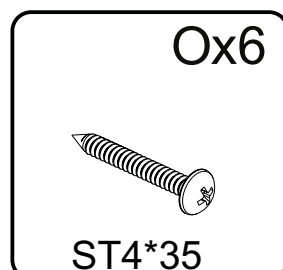
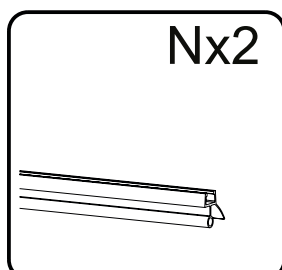
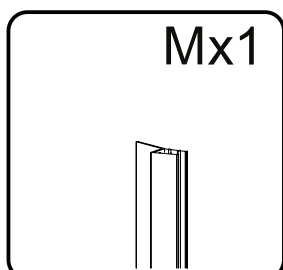
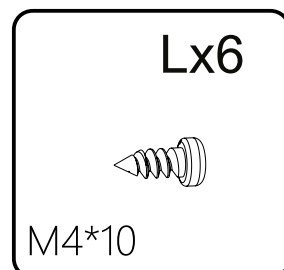
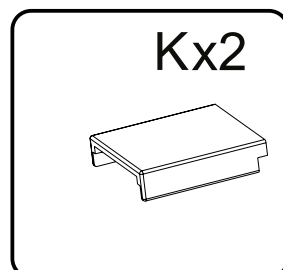
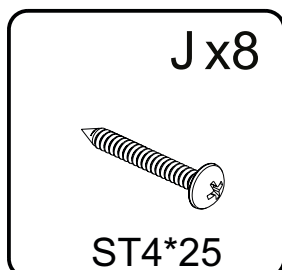
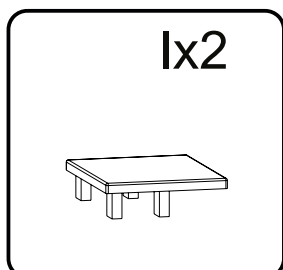
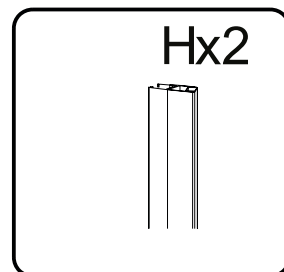
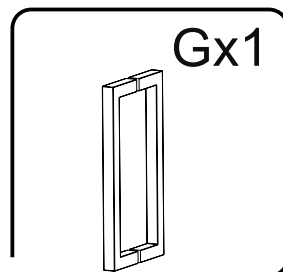
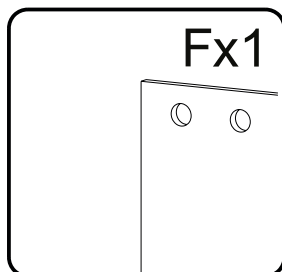
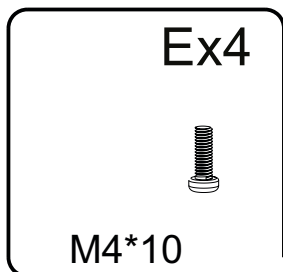
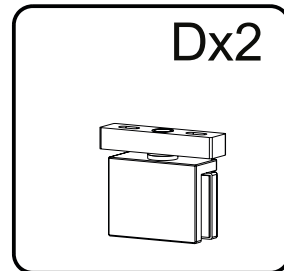
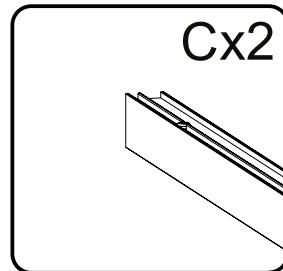
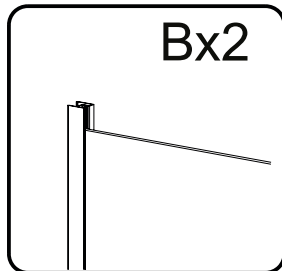
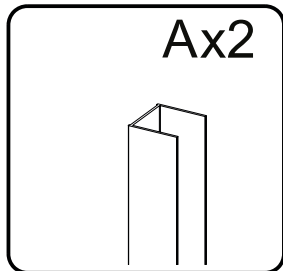

## шаг 1

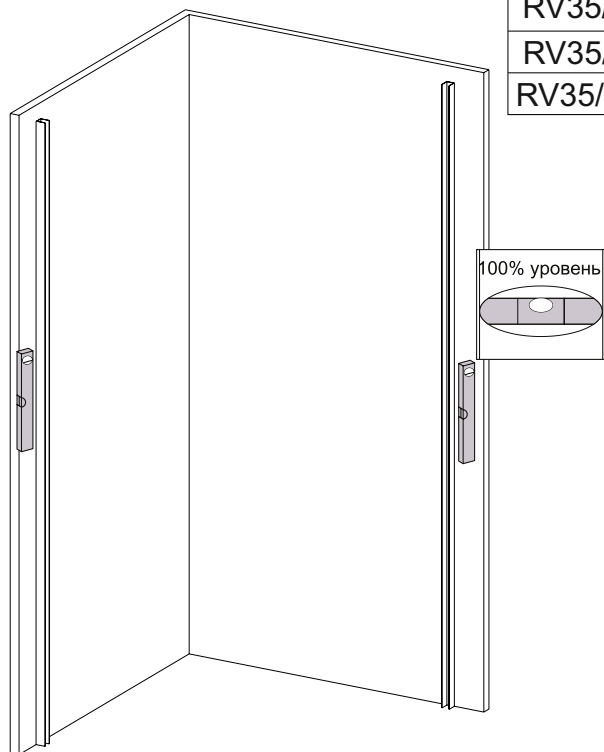

Артикул	Монтажный размер L, мм
RV35/35B-80-01-C7	785-800x785-800
RV35/35B-90-01-C7	885-900x885-900
RV35/35B-100-01-C7	985-1000x985-1000

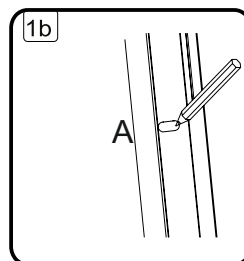
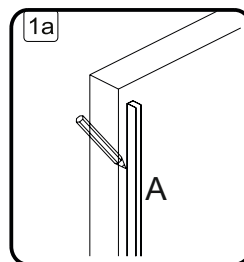

## шаг 2

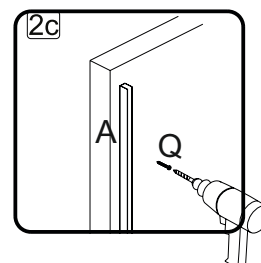
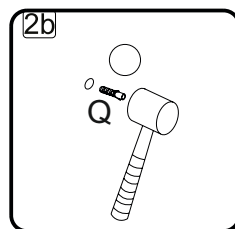
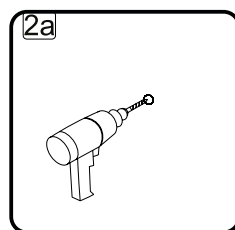
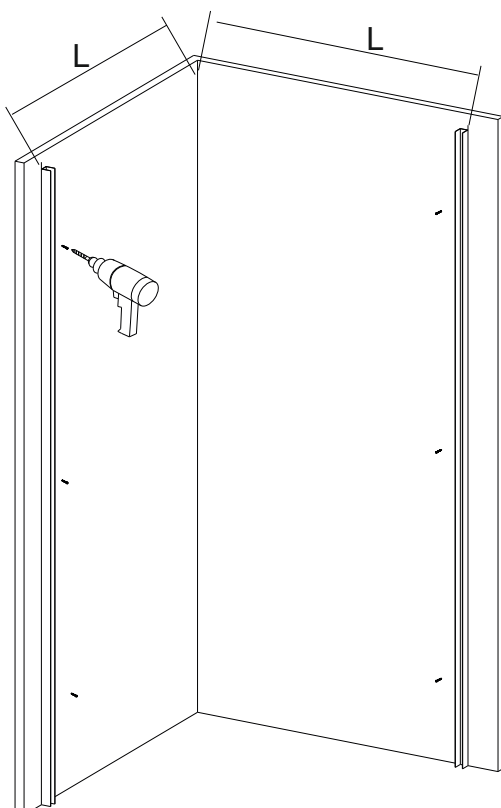

## шаг 3

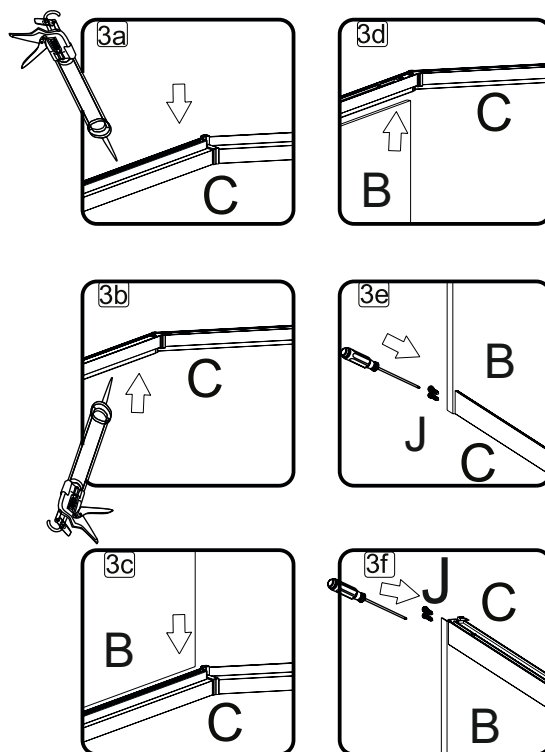
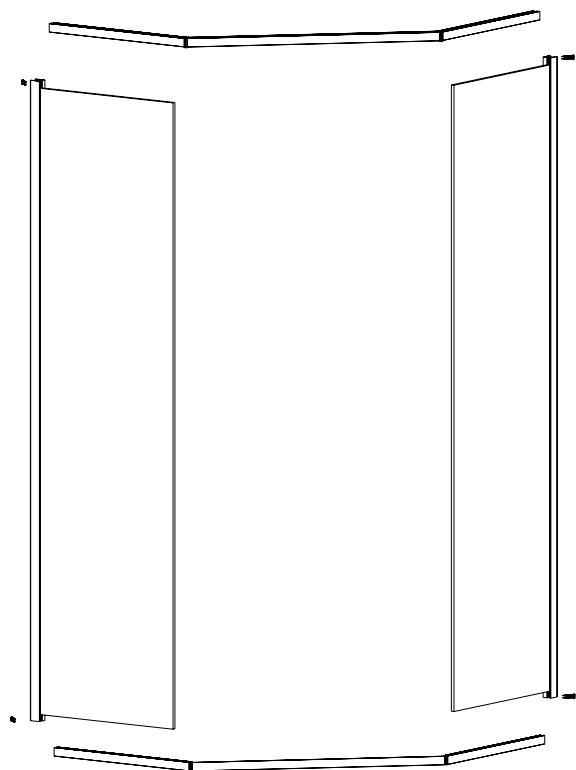

## шаг 4

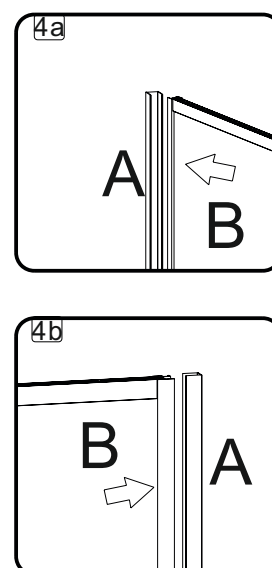
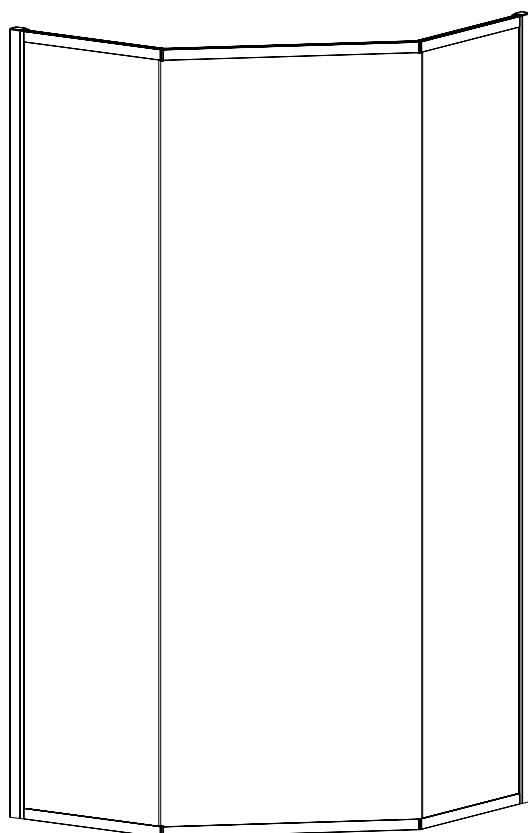

## шаг 5

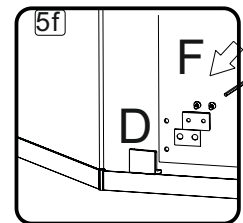
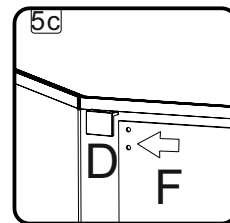
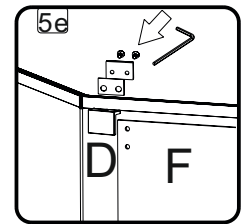
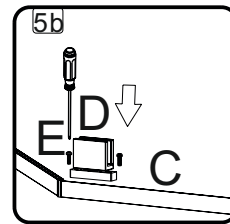
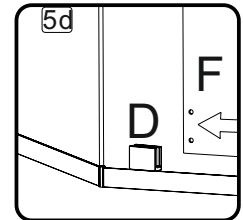
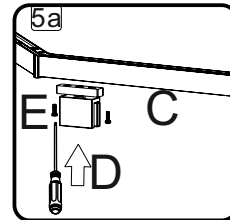
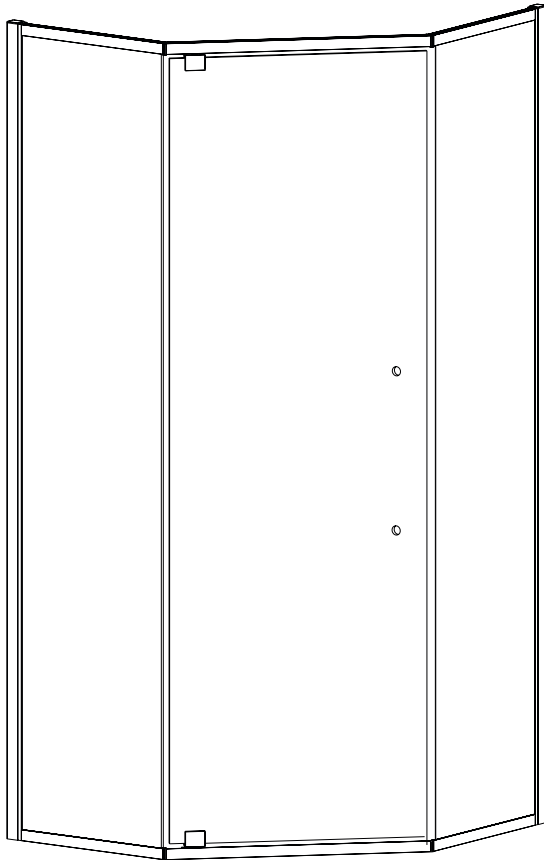

## шаг 6

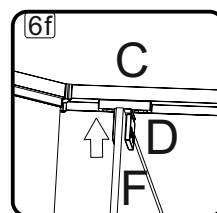
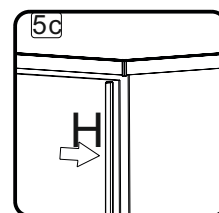
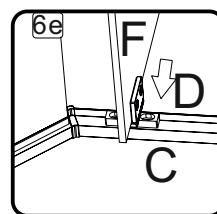
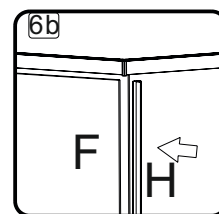
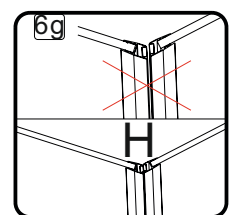
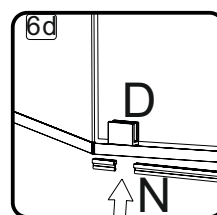
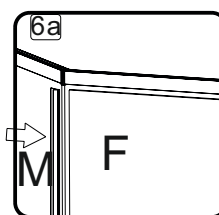
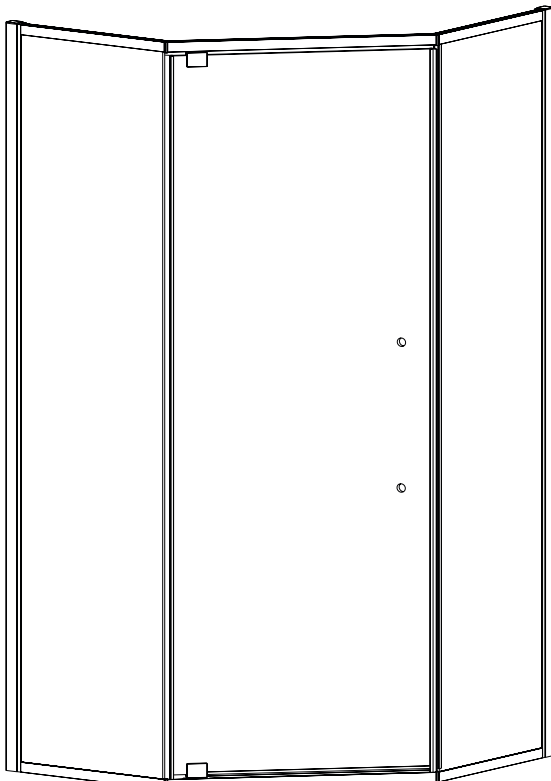

шаг 5

