



# Architecture

21034  
London  
Great Britain  
Londres  
Grande-Bretagne  
Londres  
Gran Bretaña



[LEGO.com/architecture/booklet](http://LEGO.com/architecture/booklet)

# London

Originally founded by the Romans over 2,000 years ago, London has grown to become the cultural and economic capital of Britain and one of the world's truly global cities.

Famous for its finance, fashion and arts industries, London is the world's most visited city and also one of its most

culturally diverse; more than 300 languages are spoken by its population of over 8.5 million people.

Standing on the River Thames, London's skyline reflects both the city's diverse and colorful past and its continued ambition to embrace bold, modern architectural statements.

*[ "When a man is tired of London, he is tired of life;  
for there is in London all that life can afford." ]*

Samuel Johnson



## The National Gallery

From the very start, the aim of the National Gallery was to ensure that the widest public possible could enjoy its collection. When Parliament agreed to pay for the construction of a new gallery in 1831, there were lengthy discussions about where the building should be located. Trafalgar Square was eventually chosen, as it was considered to be at the very center of the city and therefore accessible by all classes of London society. Construction began in 1832 and the new gallery was finally completed in 1838.

The building has been enlarged and altered many times as the National Gallery's collection grew and today holds over 2,300 works of art. Over six million people visit the Gallery every year to enjoy works by Leonardo da Vinci, Vincent Van Gogh and J.M.W. Turner.







## Nelson's Column



The 169 ft. (51.6 m) column stands in front of the National Gallery in Trafalgar Square and was erected between 1840 and 1843 to commemorate the British naval hero Admiral Horatio Nelson, who died at the Battle of Trafalgar in 1805.

The pedestal upon which the column stands is decorated with four bronze reliefs; each one is 18 ft. (5.5 m) square and cast from captured French guns.

## Big Ben



Big Ben (the Great Bell), officially known as the Elizabeth Tower (formerly known as the Clock Tower and renamed in 2012 in honor of Queen Elizabeth's Diamond Jubilee), has stood at the northeastern corner of the Palace of Westminster for over 150 years. The 316 ft. (96.3 m) neo-gothic styled tower is one of the most recognized and photographed landmarks in London today and an integral part of the city's skyline. The tower's clock mechanism is wound by hand three times a week and is still as accurate today as when it was constructed over 150 years ago.



# London Eye

Opened in 2000 to mark the new millennium, the London Eye is still the world's largest cantilevered observation wheel. With a height of 443 ft. (135 m), this remarkable feat of design and engineering has become the UK's most popular paid attraction, with 3.75 million visitors every year. On a clear day it is possible to see up to 25 miles (40.2 km) in the distance from the top of the wheel.

Originally intended as a temporary structure, the London Eye is now a permanent fixture of the London skyline and an iconic symbol of modern London.











## Tower Bridge

It took eight years and 11,000 tons of steel to construct the 213 ft. (65 m) tall Tower Bridge, and when it opened in June 1894 it was regarded as the most sophisticated bridge of its type in the world. The framework was clad in Cornish granite and Portland stone to protect the underlying steelwork, and to give the Bridge a more pleasing appearance. Built with giant moveable roadways that lift up for passing ships, it is still considered an engineering marvel and arguably remains the most recognized bridge in the world.

# Londres

Fondée à l'origine par les Romains il y a plus de 2 000 ans, Londres est devenue la capitale culturelle et économique de la Grande-Bretagne et l'une des grandes villes mondiales.

Célèbre dans les domaines de la finance, de la mode et des arts, Londres est la ville la plus visitée au monde et aussi l'une des plus multiculturelles : plus de 300 langues y sont parlées par sa population de plus de 8,5 millions d'habitants.

Située sur la Tamise, la silhouette de Londres reflète à la fois le passé divers et coloré de la ville et son ambition continue d'adopter des réalisations architecturales modernes et audacieuses.

[ « *Quand un homme est fatigué de Londres, il est fatigué de la vie, car on trouve à Londres tout ce que la vie peut offrir.* » ]

Samuel Johnson



## La National Gallery

Depuis sa création, le but de la National Gallery est d'assurer que le plus de monde possible puisse apprécier sa collection. Lorsque le Parlement accepta de financer la construction d'une nouvelle galerie en 1831, il y eut de longues discussions à propos de l'endroit où le bâtiment devait être situé. Trafalgar Square fut finalement choisi, car cette place était considérée comme le centre de la ville et par conséquent accessible à toutes les classes de la société londonienne. La construction commença en 1832 et la nouvelle galerie fut finalement achevée en 1838.

Le bâtiment a été agrandi et modifié de nombreuses fois alors que la collection de la National Gallery s'enrichissait. Elle comprend aujourd'hui plus de 2 300 œuvres d'art. Plus de six millions de personnes visitent la National Gallery chaque année pour admirer les œuvres de Léonard de Vinci, Vincent Van Gogh et J. M. W. Turner.







## La colonne Nelson



Cette colonne haute de 51,6 m se tient devant la National Gallery à Trafalgar Square et a été érigée entre 1840 et 1843 pour commémorer Horatio Nelson, amiral héroïque de la marine britannique tué lors de la bataille de Trafalgar en 1805. Le piédestal sur lequel repose la colonne est décoré de quatre reliefs en bronze, mesurant 5,5 mètres carrés chacun et coulés à partir de canons français.

## Big Ben



Big Ben (la grande cloche), officiellement connue sous le nom de Tour Elizabeth (appelée par le passé Tour de l'horloge et renommée en l'honneur du jubilé de diamant de la reine Elizabeth en 2012), se tient dans le coin nord-est du palais de Westminster depuis plus de 150 ans. Cette tour de style néogothique de 96,3 m est l'un des monuments les plus reconnaissables et les plus photographiés à Londres aujourd'hui et un élément caractéristique de la silhouette de Londres. Le mécanisme de l'horloge de la tour est remonté à la main trois fois par semaine et il est toujours aussi précis aujourd'hui que lors de sa construction il y a plus de 150 ans.





## Le London Eye

Ouvert en 2000 pour marquer le nouveau millénaire, le London Eye est toujours la plus grande roue d'observation du monde. Avec une hauteur de 135 m, cette remarquable réalisation de design et d'ingénierie est devenue l'attraction payante la plus populaire au Royaume-Uni, avec 3,75 millions de visiteurs chaque année. Par temps clair, il est possible de voir jusqu'à 40,2 km de distance depuis le haut de la roue.

Conçu à l'origine comme une structure temporaire, le London Eye est maintenant un élément permanent de l'architecture de la ville et un célèbre symbole de la modernité de Londres.







## Le Tower Bridge

Il a fallu huit ans et 11 000 tonnes d'acier pour construire le Tower Bridge, haut de 65 m. Lors de son inauguration en juin 1894, il fut considéré comme le pont de ce type le plus sophistiqué au monde. Sa charpente a été recouverte de granit de Cornouailles et de pierre de Portland pour protéger la structure en acier sous-jacente et pour donner au pont un aspect plus agréable. Construit avec des travées mobiles géantes qui se soulèvent pour laisser passer les bateaux, il est toujours considéré comme une merveille d'ingénierie et reste le pont le plus reconnu au monde.

# Londres

Fundada originalmente por los romanos hace más de 2000 años, Londres ha crecido hasta convertirse en la capital económica y cultural de Gran Bretaña y una de las ciudades más cosmopolitas del mundo.

Célebre por sus industrias financiera, de la moda y del arte, Londres es la ciudad más visitada del planeta y una de las

más diversas a nivel cultural: sus más de 8,5 millones de habitantes hablan más de 300 idiomas.

Erigido a orillas del río Támesis, el horizonte de Londres refleja el pintoresco y diverso pasado de la ciudad, así como su constante deseo de abrazar los estilos arquitectónicos más atrevidos y modernos.

[ *«Cuando un hombre está cansado de Londres, está cansado de la vida, pues Londres tiene todo lo que la vida puede ofrecer».* ]

Samuel Johnson



## Galería Nacional

El principal objetivo de la Galería Nacional ha sido siempre garantizar que su colección estuviera al alcance del mayor público posible. Cuando el Parlamento acordó pagar la construcción de una nueva galería en 1831, tuvieron lugar largas discusiones sobre dónde debía ubicarse el edificio. Finalmente se eligió Trafalgar Square, pues se consideraba el centro mismo de la ciudad y, por tanto, estaba al alcance de todas las clases que componían la sociedad londinense. Las obras comenzaron en 1832 y la nueva galería se completó en 1838.

El edificio ha recibido numerosas ampliaciones y modificaciones al tiempo que crecía la colección de la Galería Nacional, hoy compuesta por más de 2.300 obras de arte. Más de seis millones de personas visitan la Galería Nacional cada año para disfrutar de las obras de Leonardo da Vinci, Vincent Van Gogh y J. M. W. Turner.









## Columna de Nelson



Esta columna de 51,6 m se encuentra en Trafalgar Square, frente a la Galería Nacional, y fue erigida entre 1840 y 1843 en memoria del almirante Horatio Nelson, célebre héroe naval británico fallecido en la Batalla de Trafalgar en 1805.

El pedestal sobre el que se apoya la columna está decorado con cuatro bajorrelieves de bronce, cada uno de 5,5 m<sup>2</sup> y fabricado a partir de las armas capturadas a los franceses.

## Big Ben



El Big Ben (la Gran Campana), conocido oficialmente como Torre de Isabel (anteriormente Torre del Reloj y rebautizado en 2012 en honor al jubileo de diamante de la reina Isabel), lleva 150 años viendo pasar el tiempo en la esquina noreste del Palacio de Westminster. Esta torre neogótica de 96,3 m de altura es uno de los monumentos más populares y fotografiados de Londres en la actualidad y forma parte integral del horizonte de la ciudad. Tres veces a la semana, un responsable da cuerda al mecanismo del reloj de la torre, que continúa siendo tan exacto hoy como cuando se construyó, hace más de 150 años.



## London Eye

Inaugurado en el año 2000 para conmemorar el nuevo milenio, el London Eye sigue siendo la noria de observación voladiza más grande del mundo. Con una altura de 135 m, esta notable proeza del diseño y la ingeniería se ha convertido en la atracción de pago más popular del Reino Unido, con 3,75 millones de visitantes cada año. En un día claro, es posible ver a una distancia de hasta 40,2 km desde el punto más alto de la noria.

Concebido originalmente como una estructura temporal, el London Eye forma hoy parte permanente del horizonte de Londres y es un emblemático símbolo de la moderna capital.







## Puente de la Torre

Hicieron falta ocho años y 11.000 toneladas de acero para construir el Puente de la Torre, de 65 m de altura. Cuando se inauguró en 1894, todos lo consideraron el puente levadizo más sofisticado del mundo. La estructura se revistió de granito de Cornualles y piedra de Portland para proteger el esqueleto de acero y ofrecer al puente un aspecto más agradable. Equipado con carreteras móviles que se levantan para facilitar el paso a los barcos, sigue considerándose una maravilla de la ingeniería y es, posiblemente, el puente más conocido del mundo.

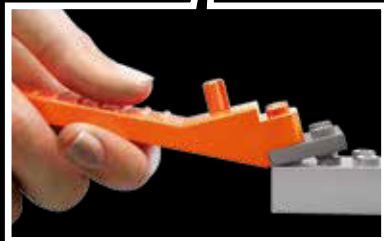
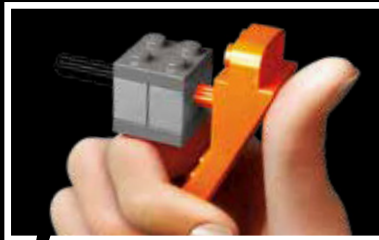
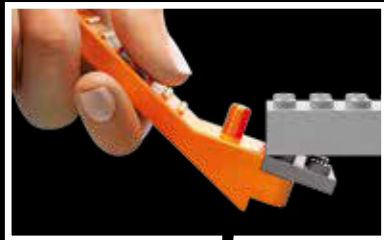

[LEGO.com/brickseparator](https://LEGO.com/brickseparator)



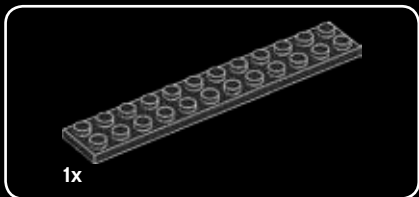
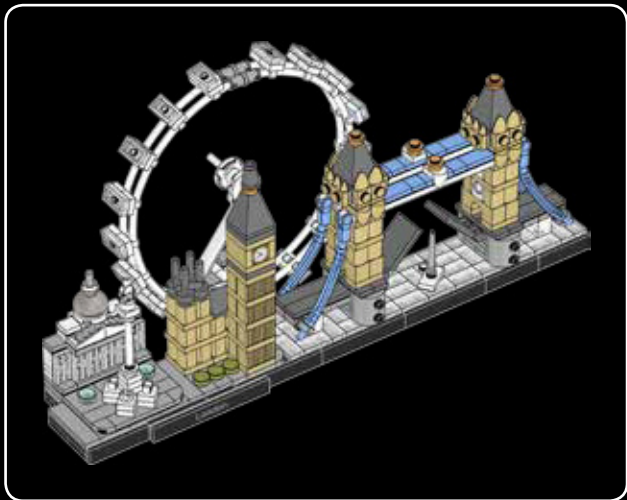

1

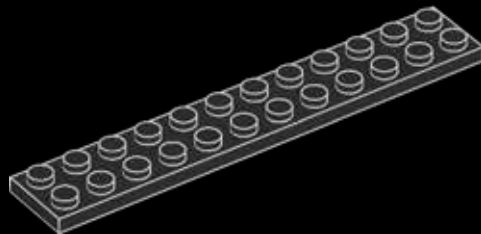

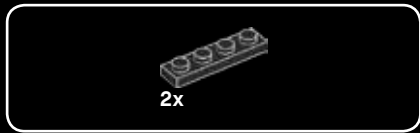

2

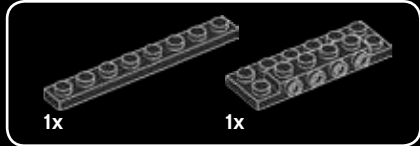
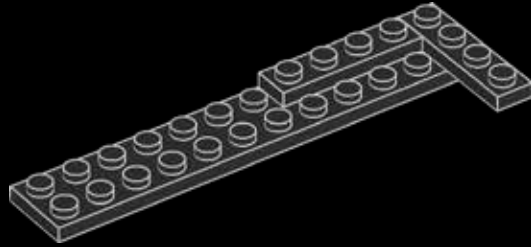

3

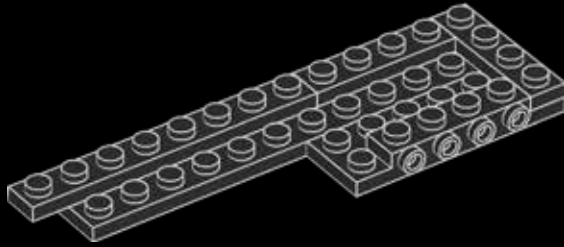

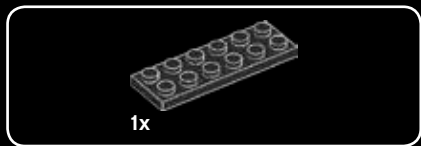

**4**

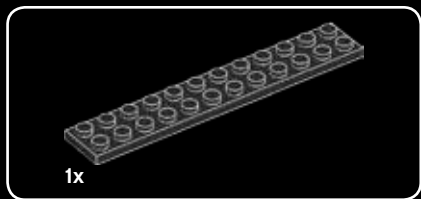
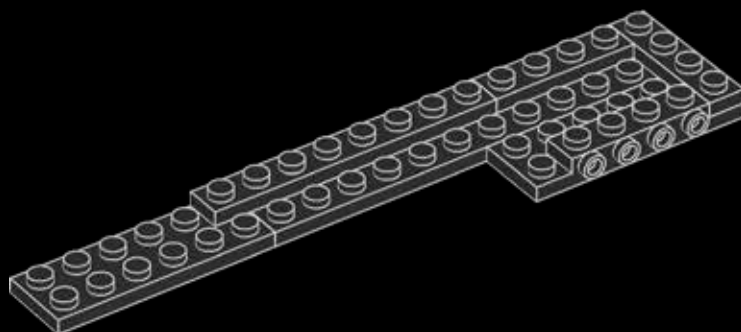

**5**

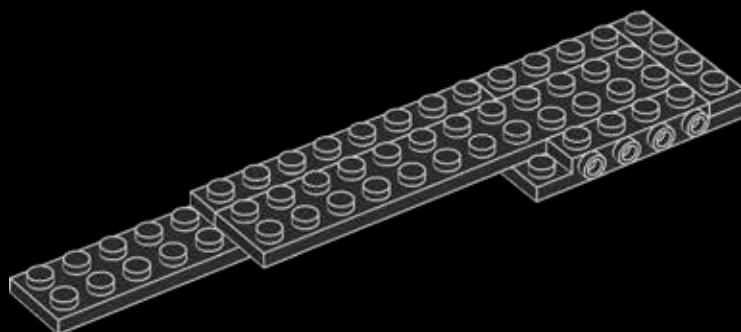



6

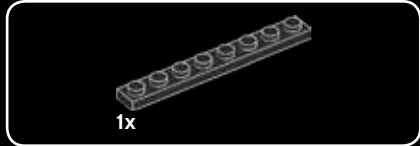
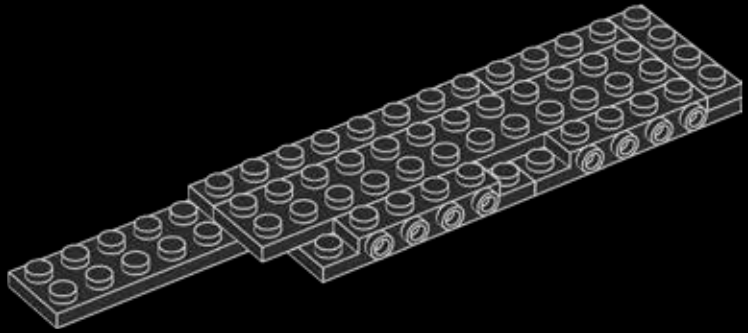

7

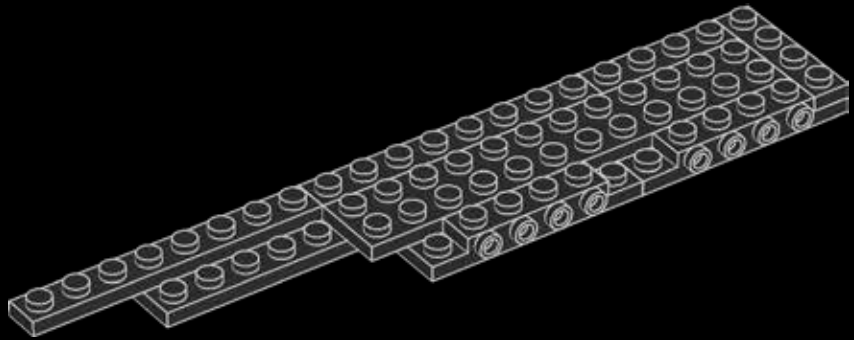



8

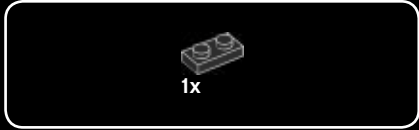
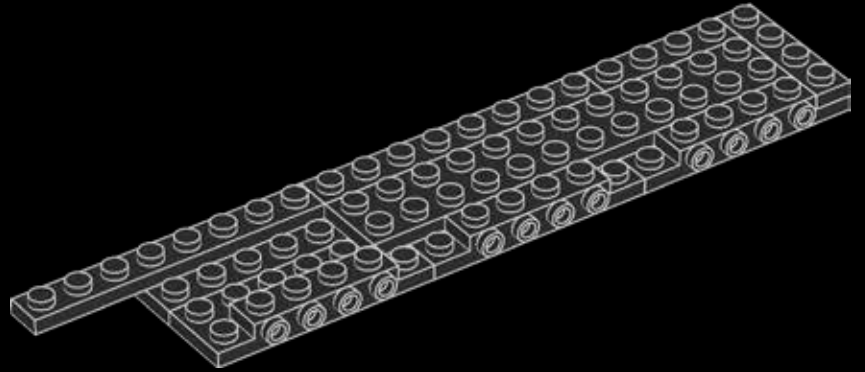

9

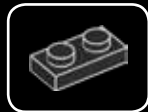
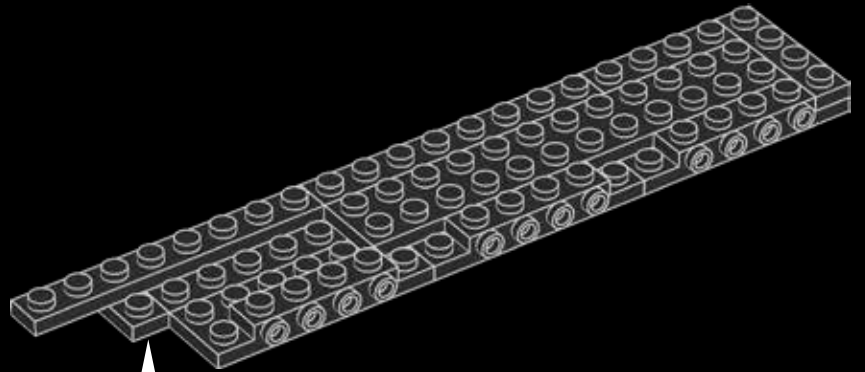

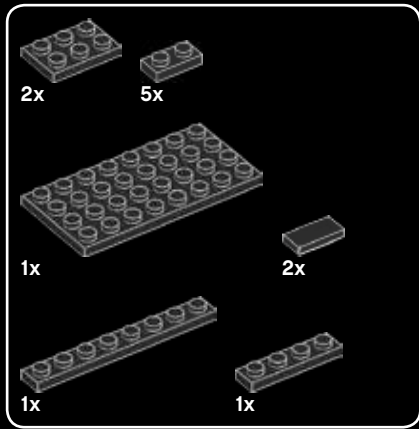

10

1

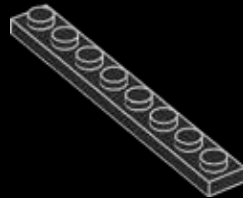

2

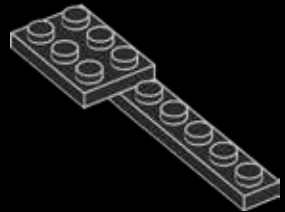

**3**

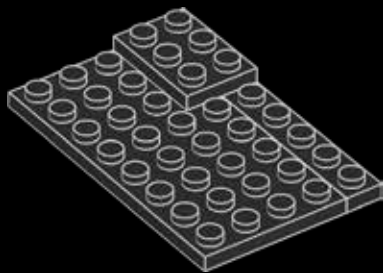

**4**

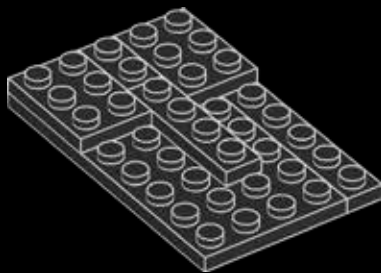

**5**

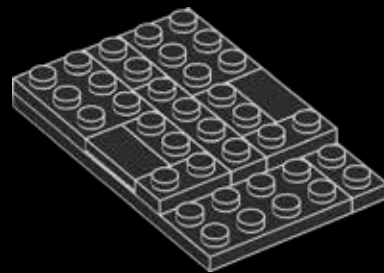

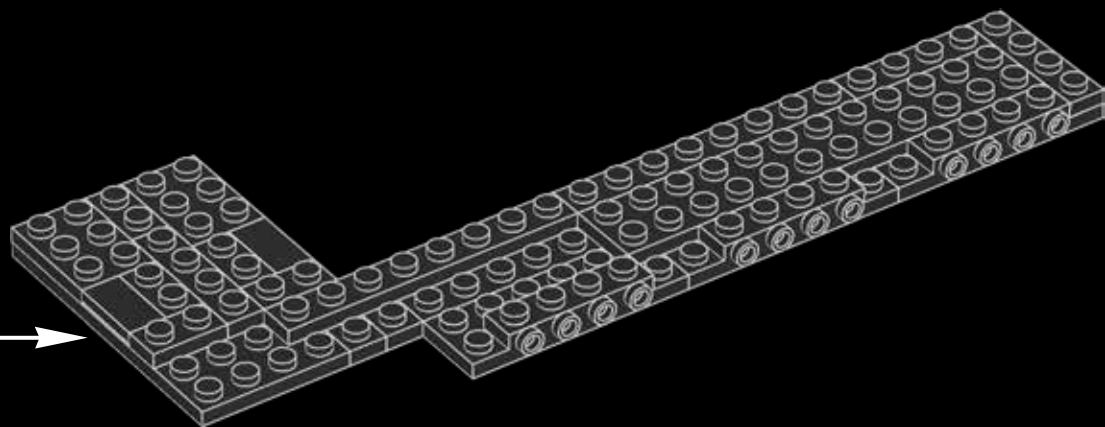



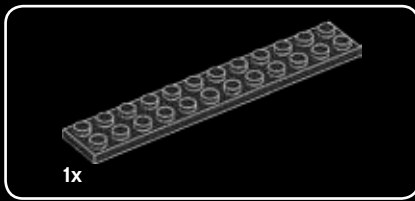

11

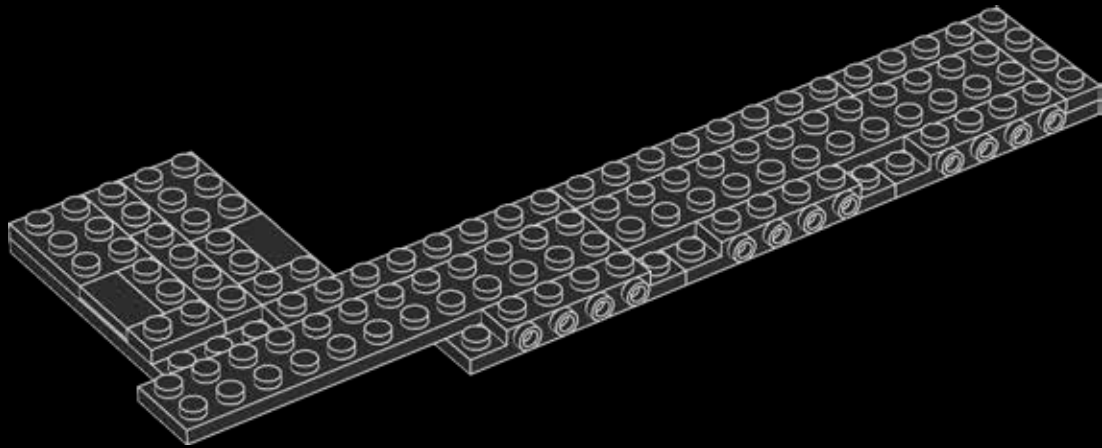



12

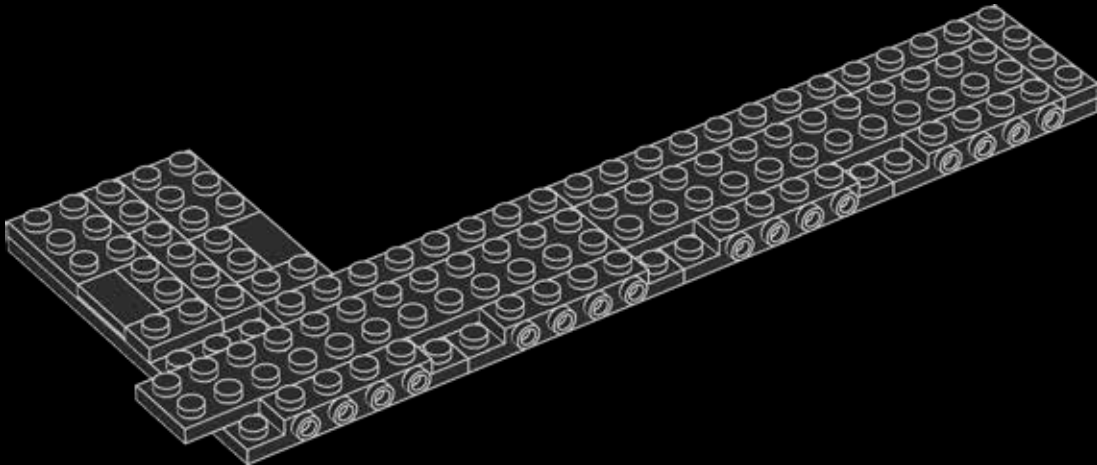



13

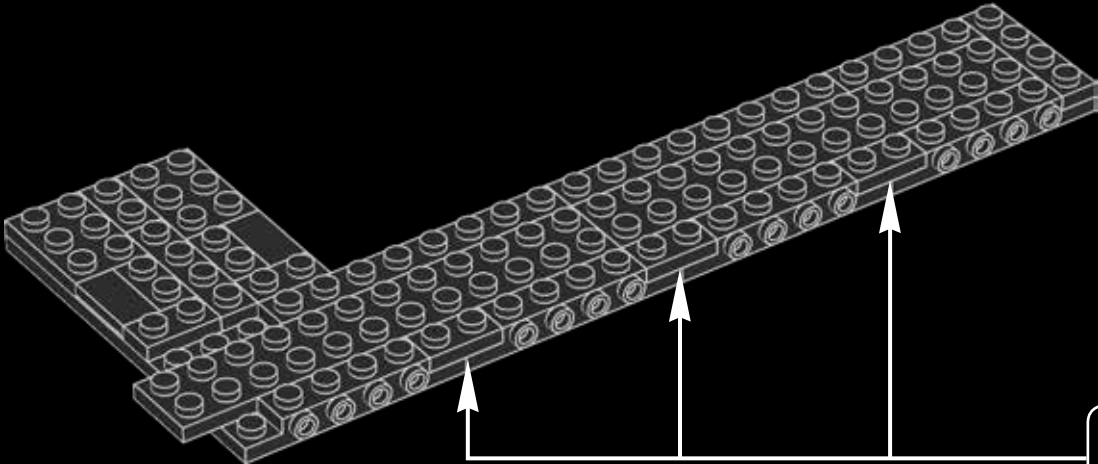

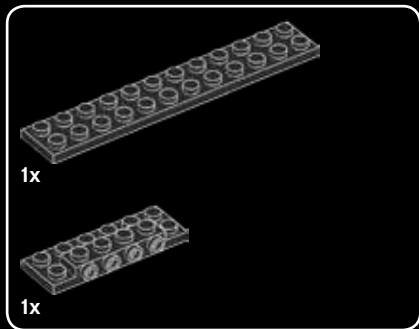

14

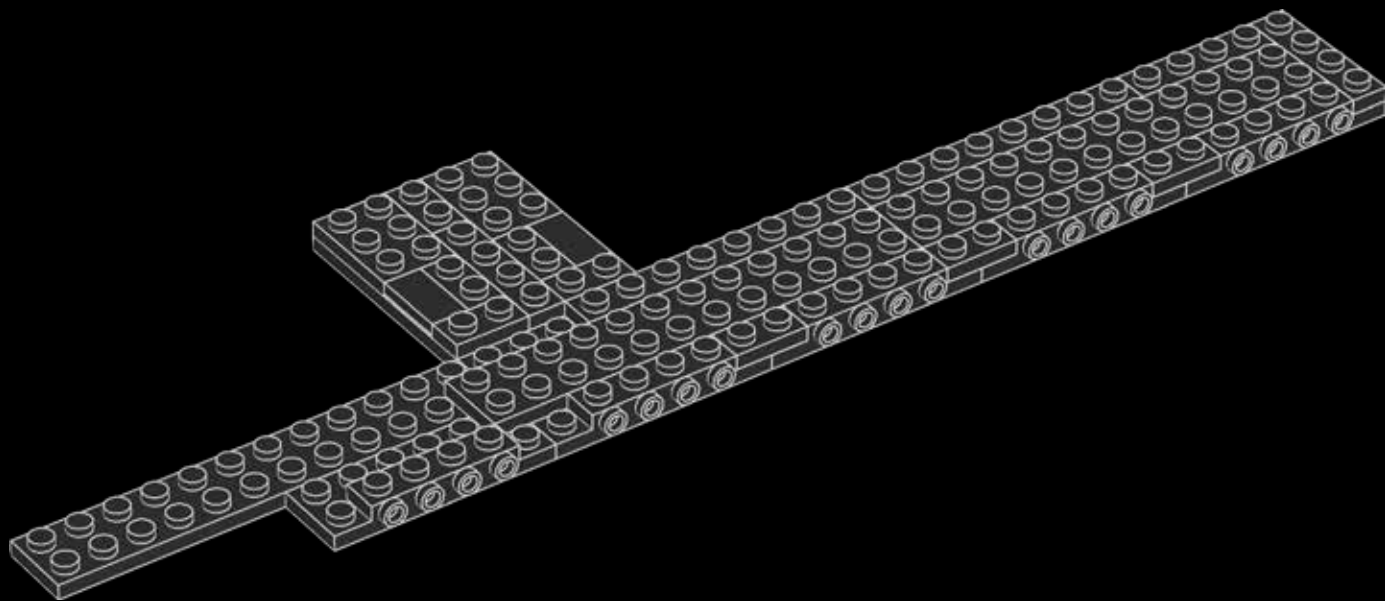

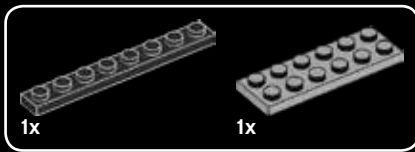

15

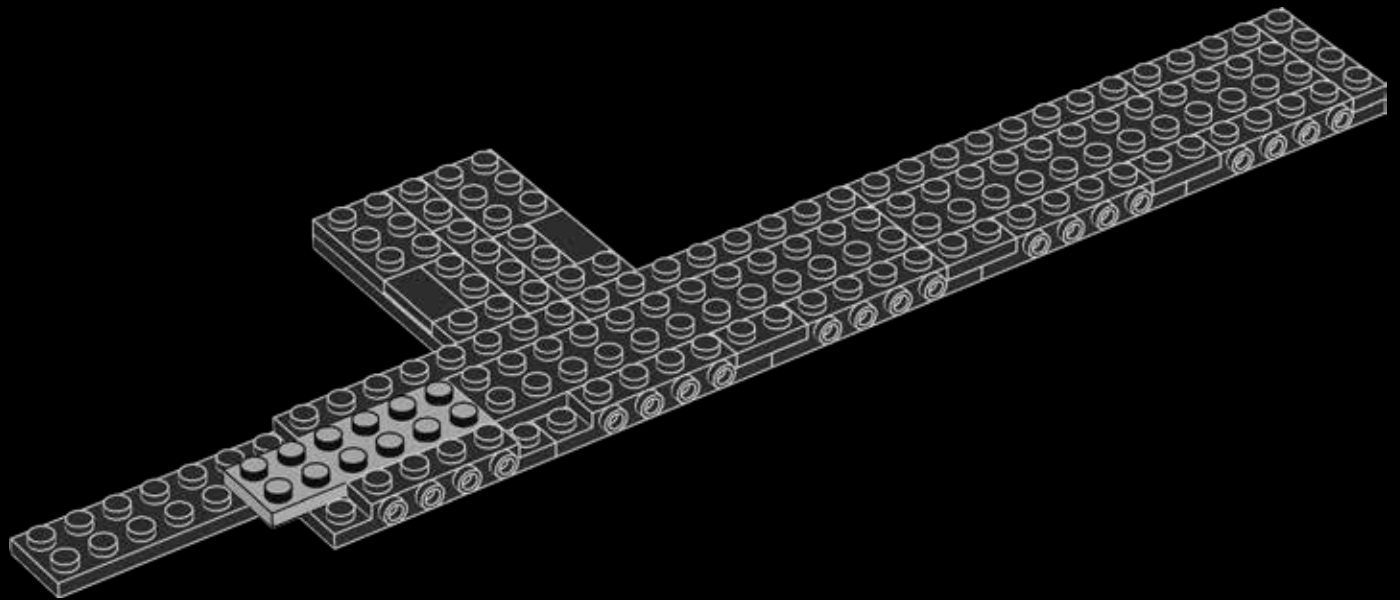



16

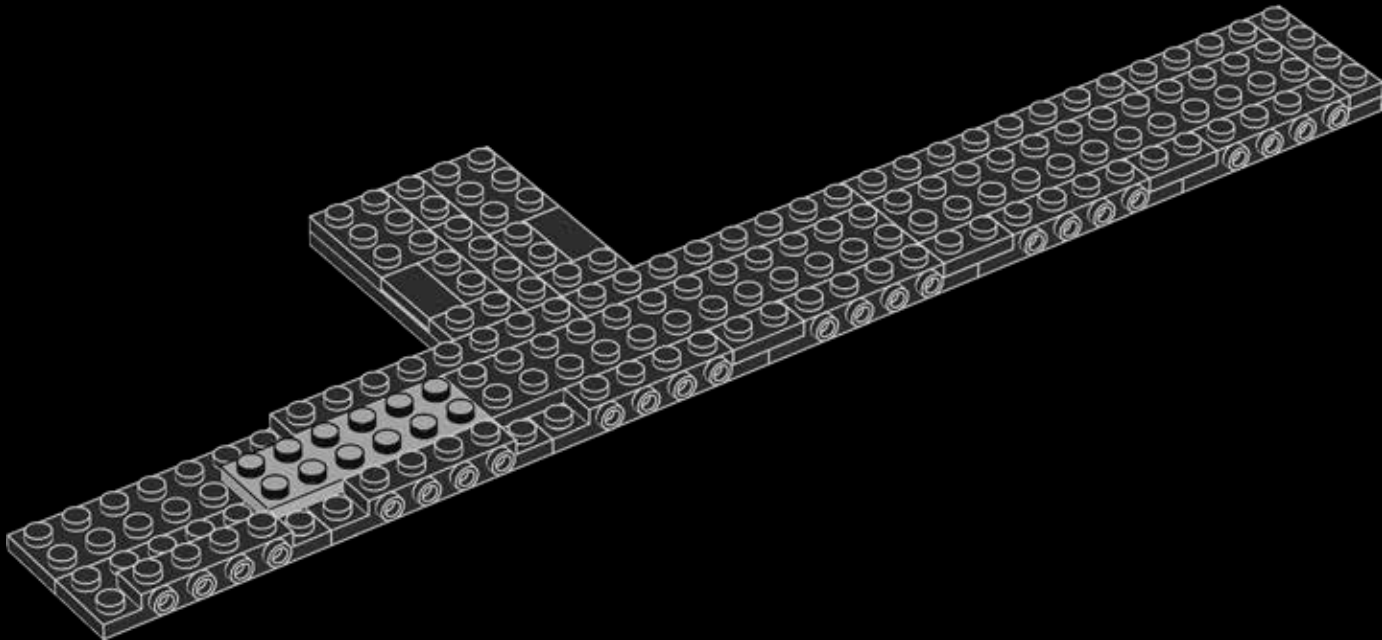

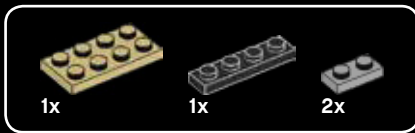

17

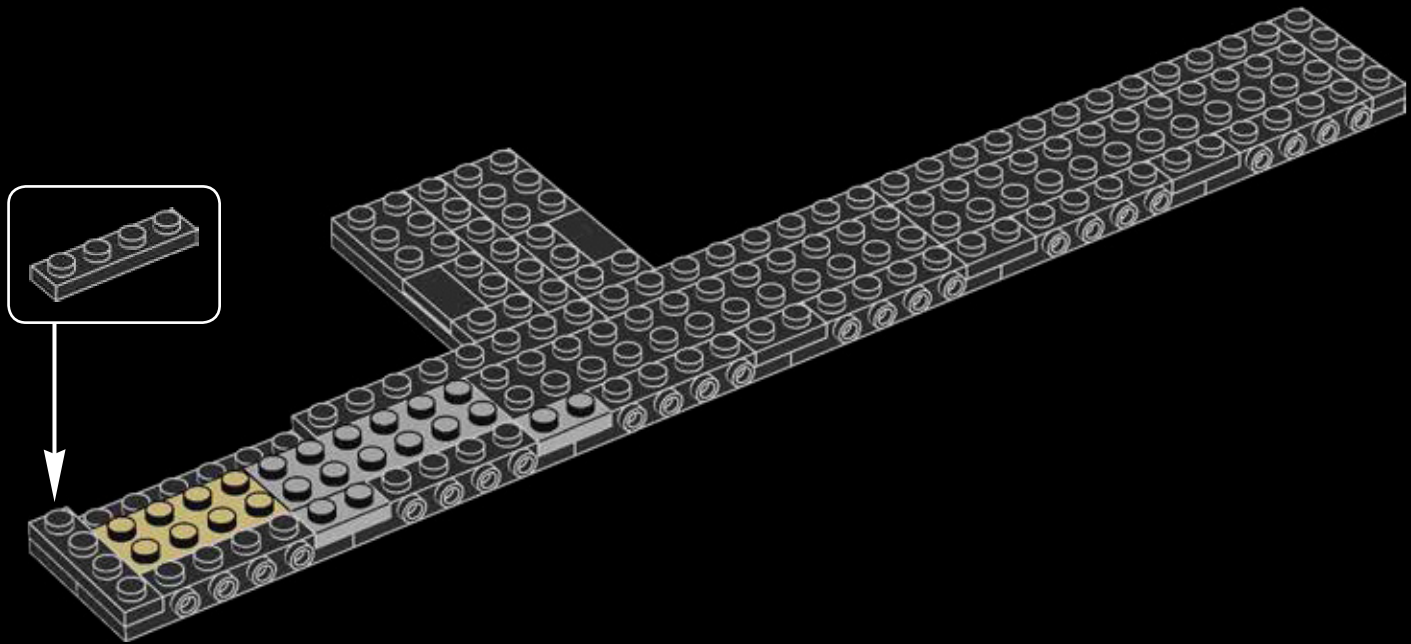

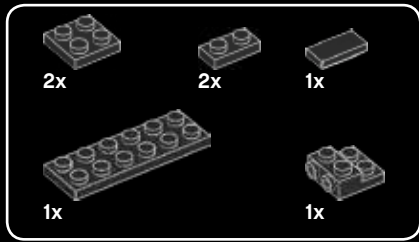

# 18

1



2

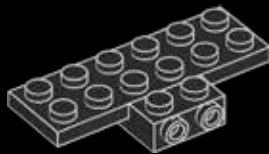

3

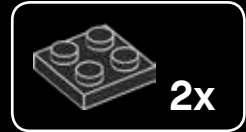
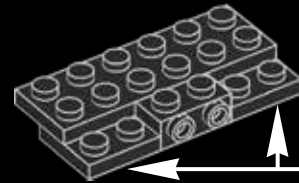

4

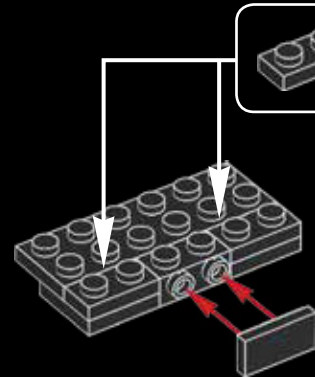



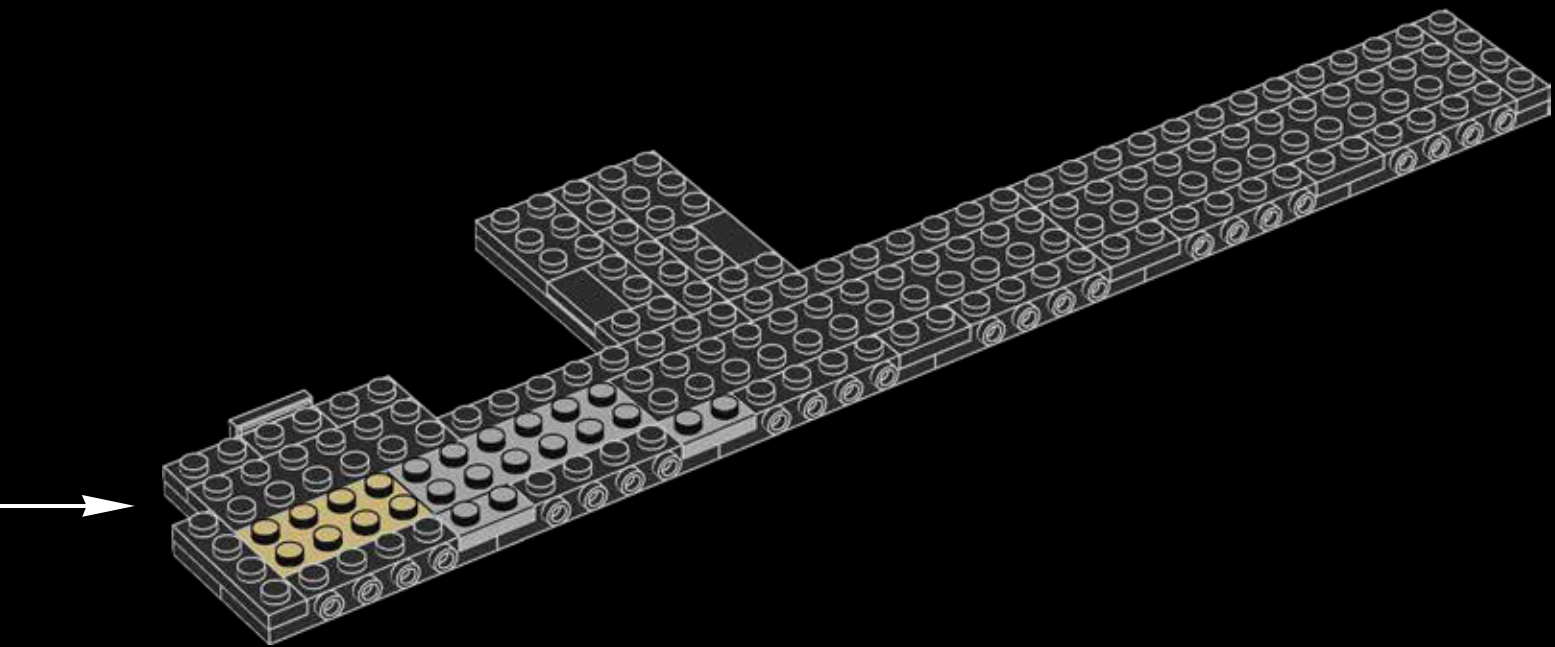



19

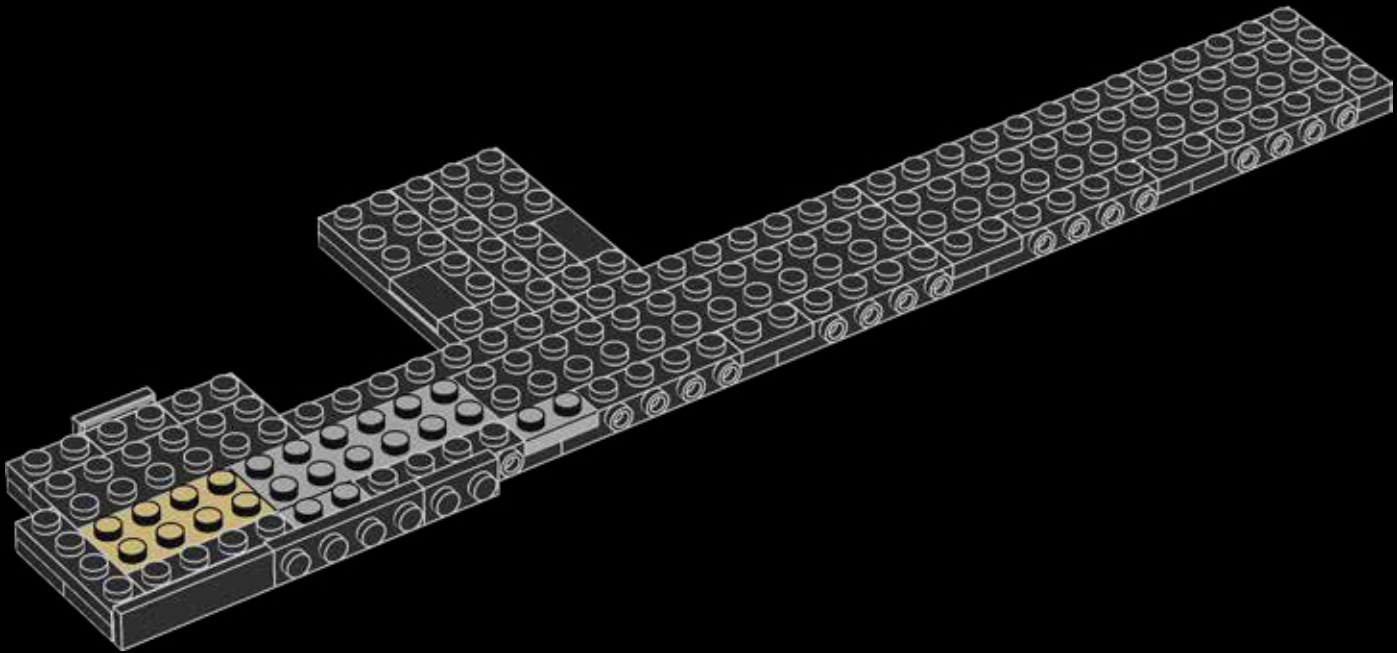

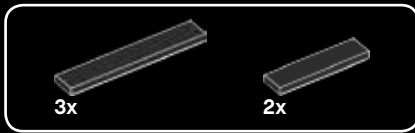

20

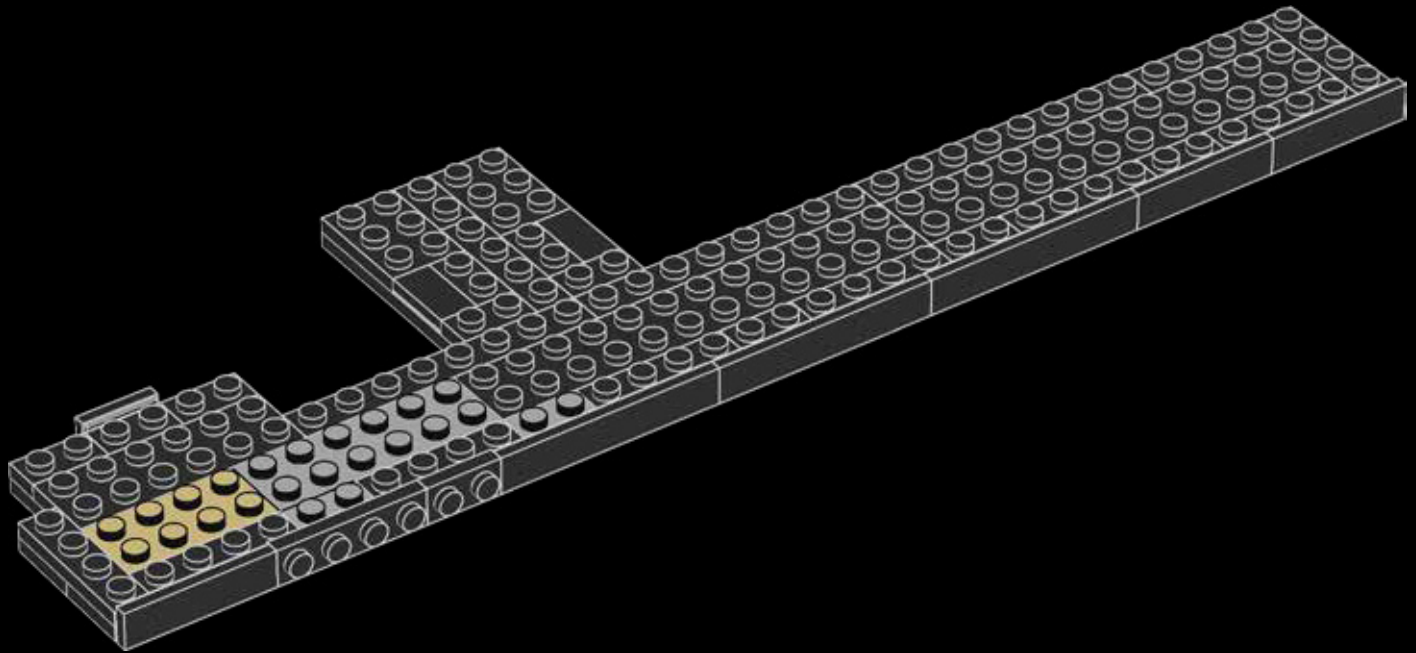

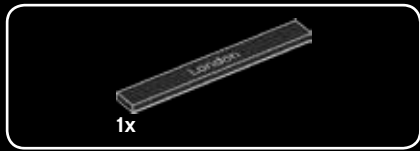

21

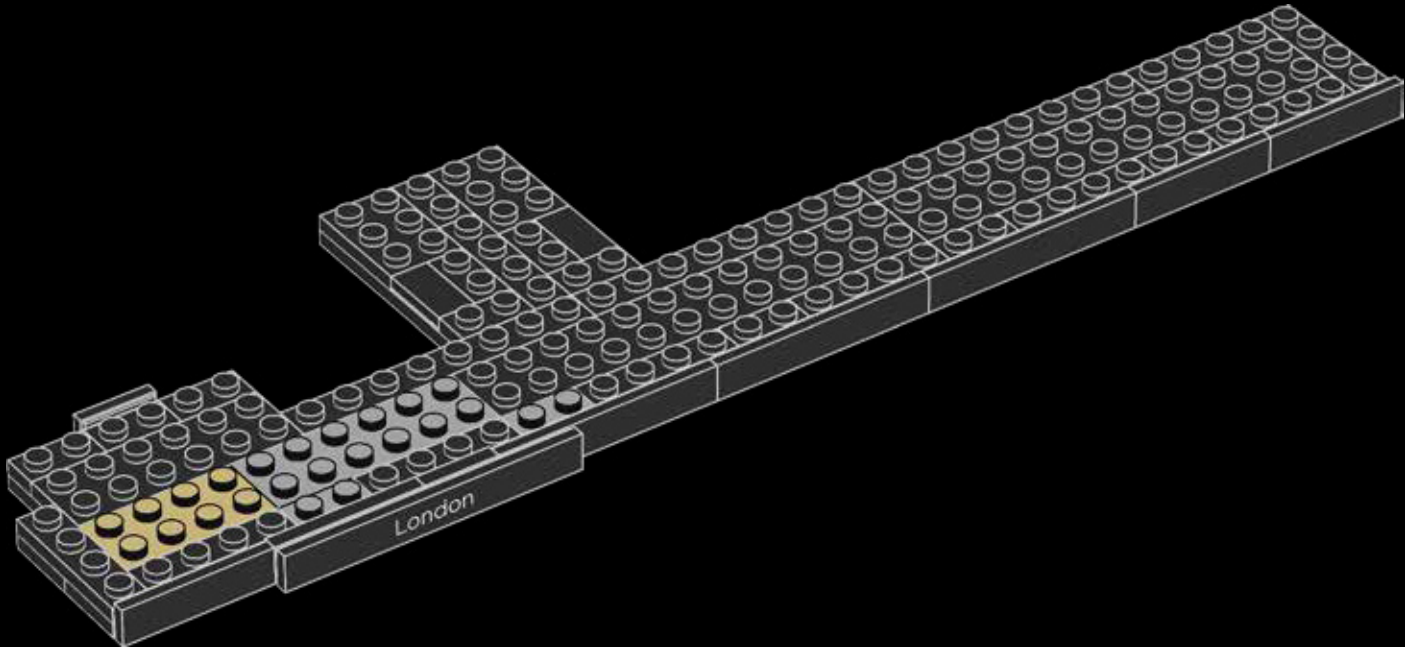

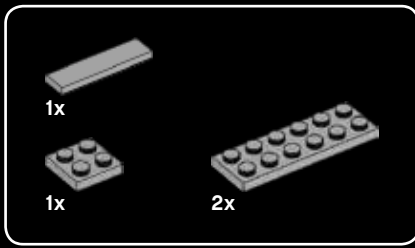

22

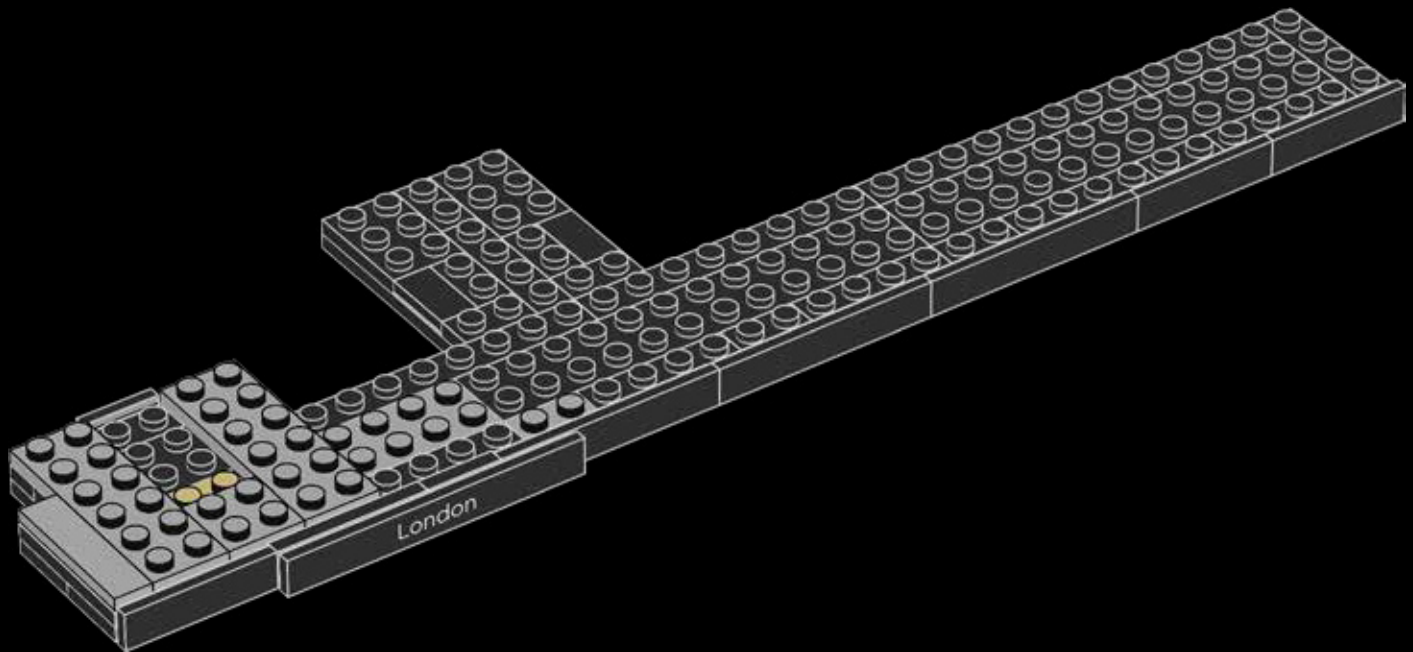

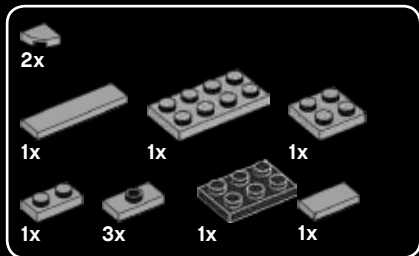

23

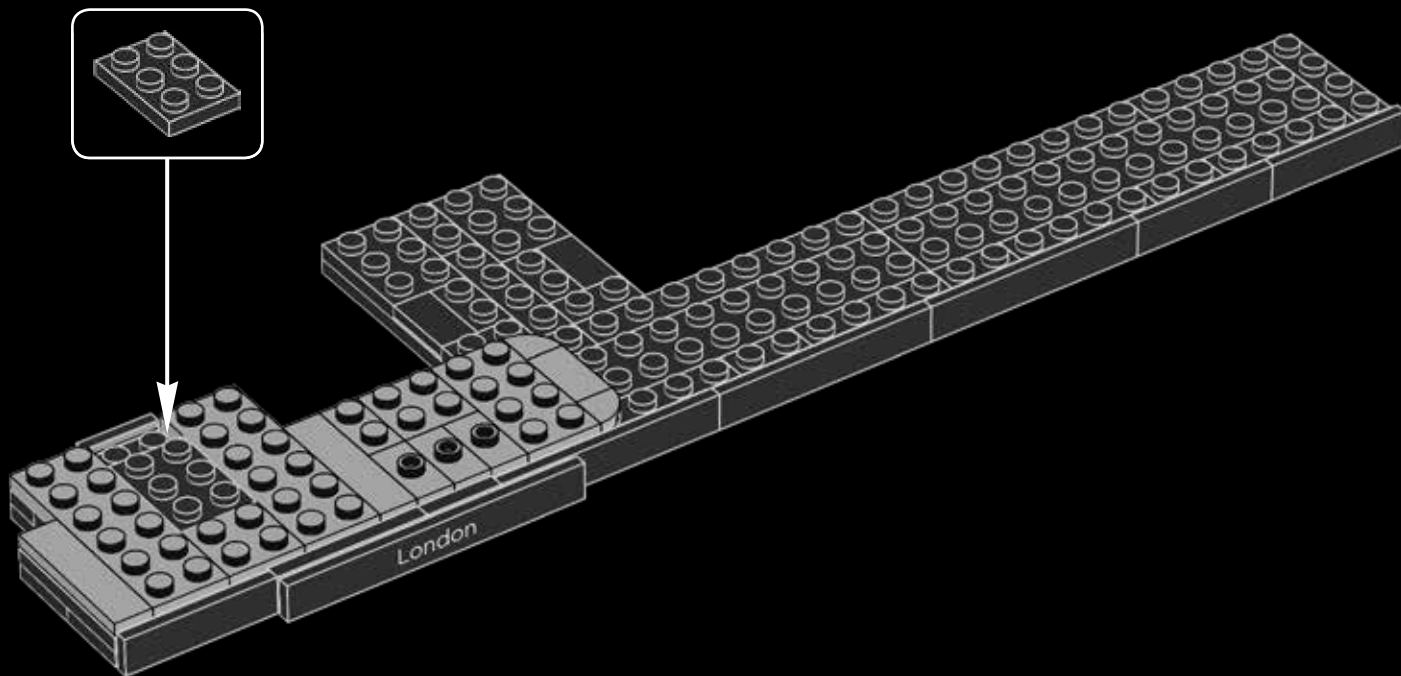



24

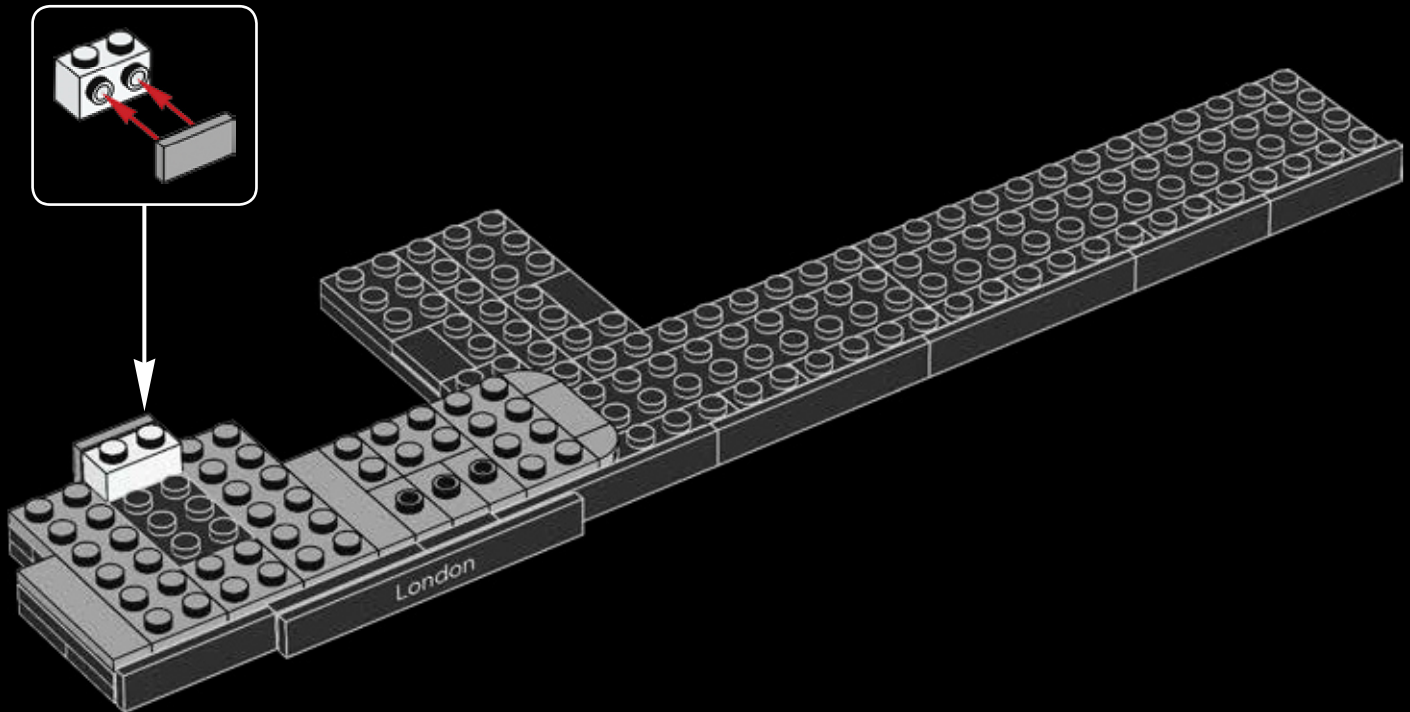

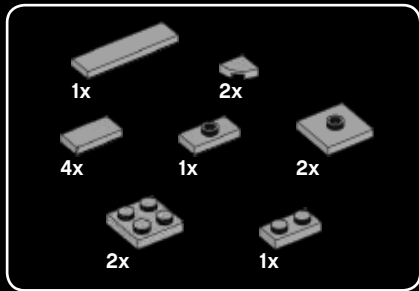

25

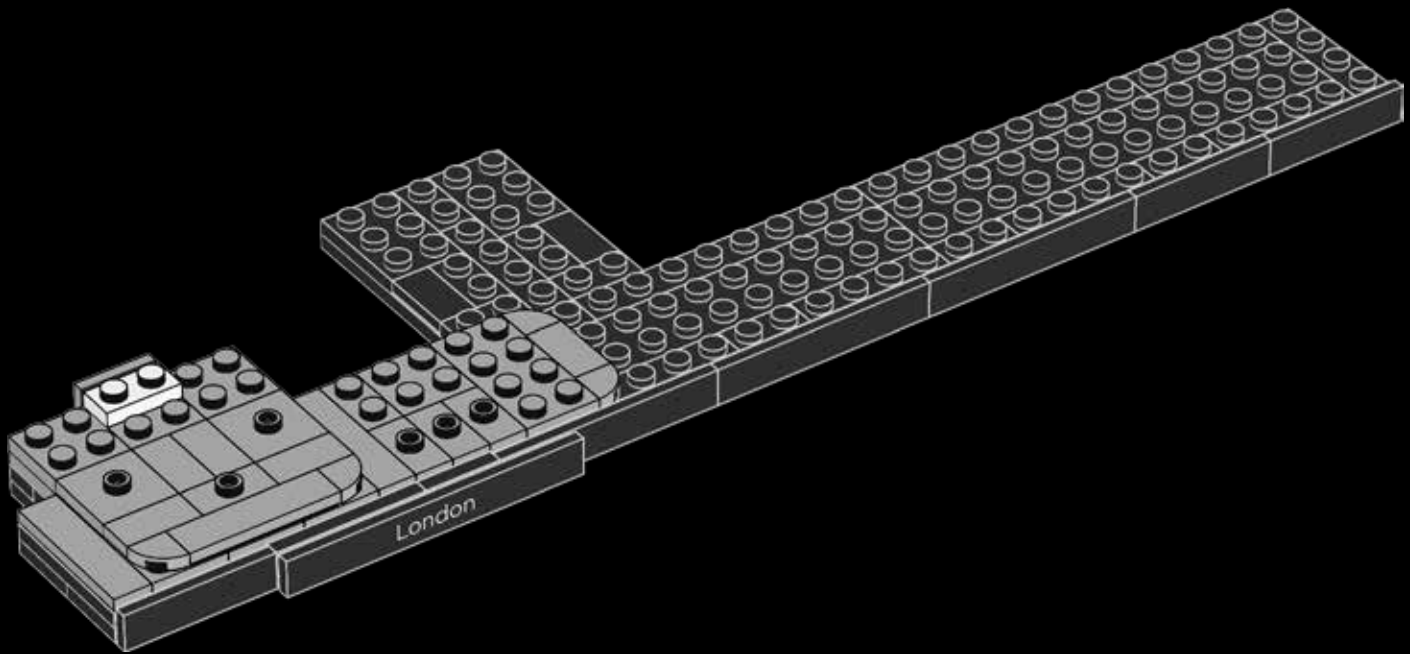



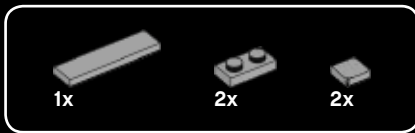

26

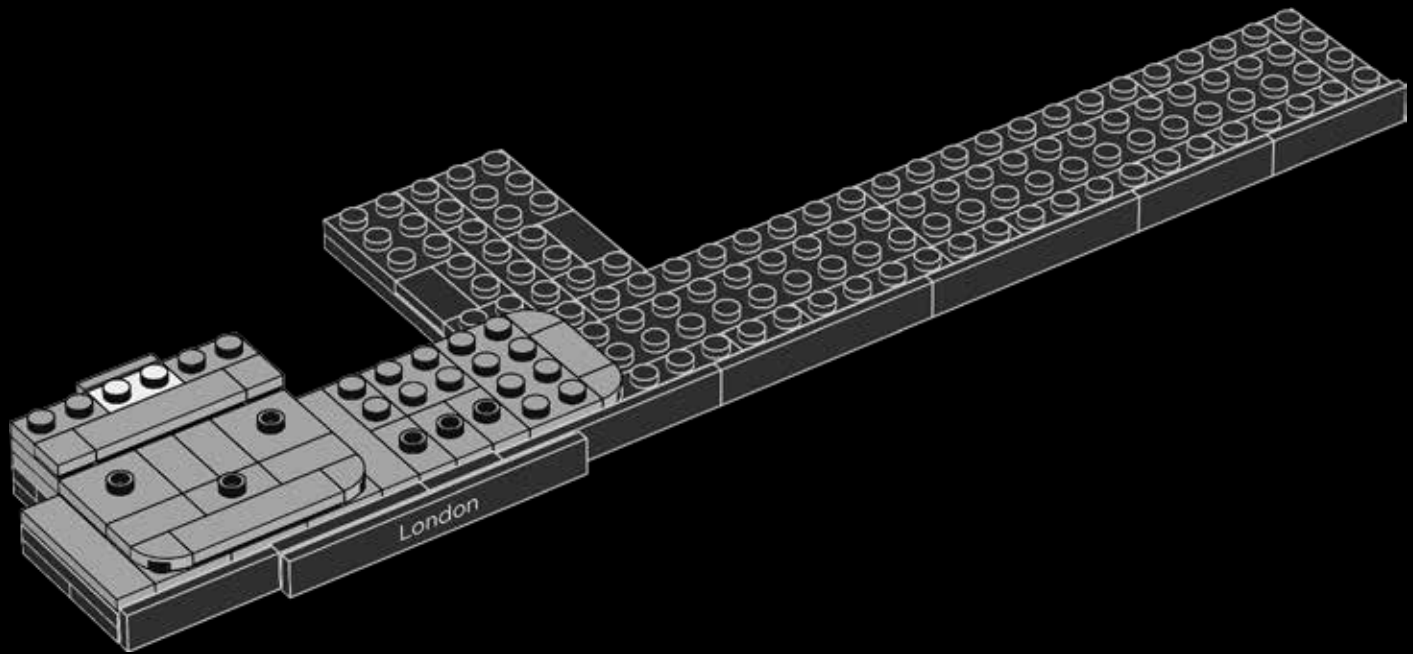

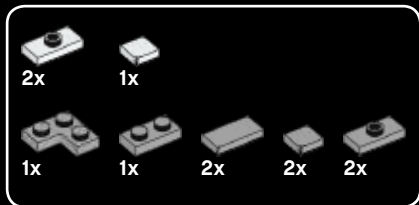

27

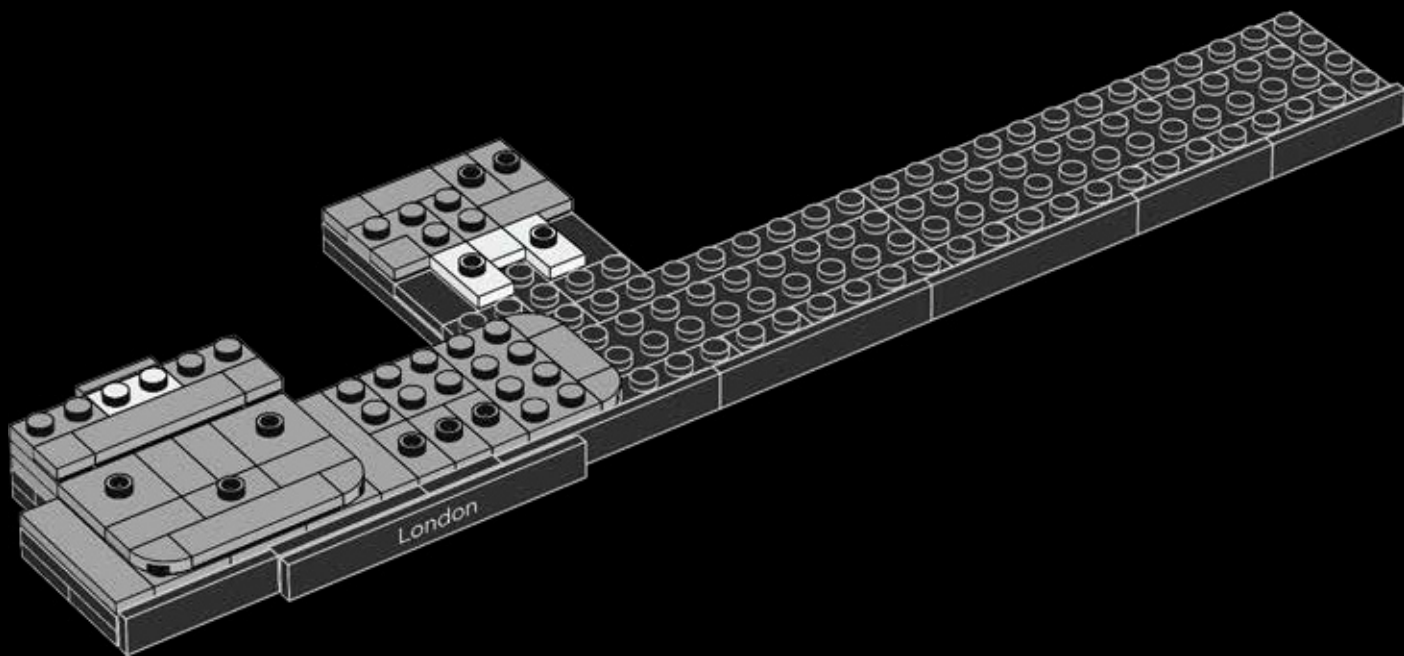



28

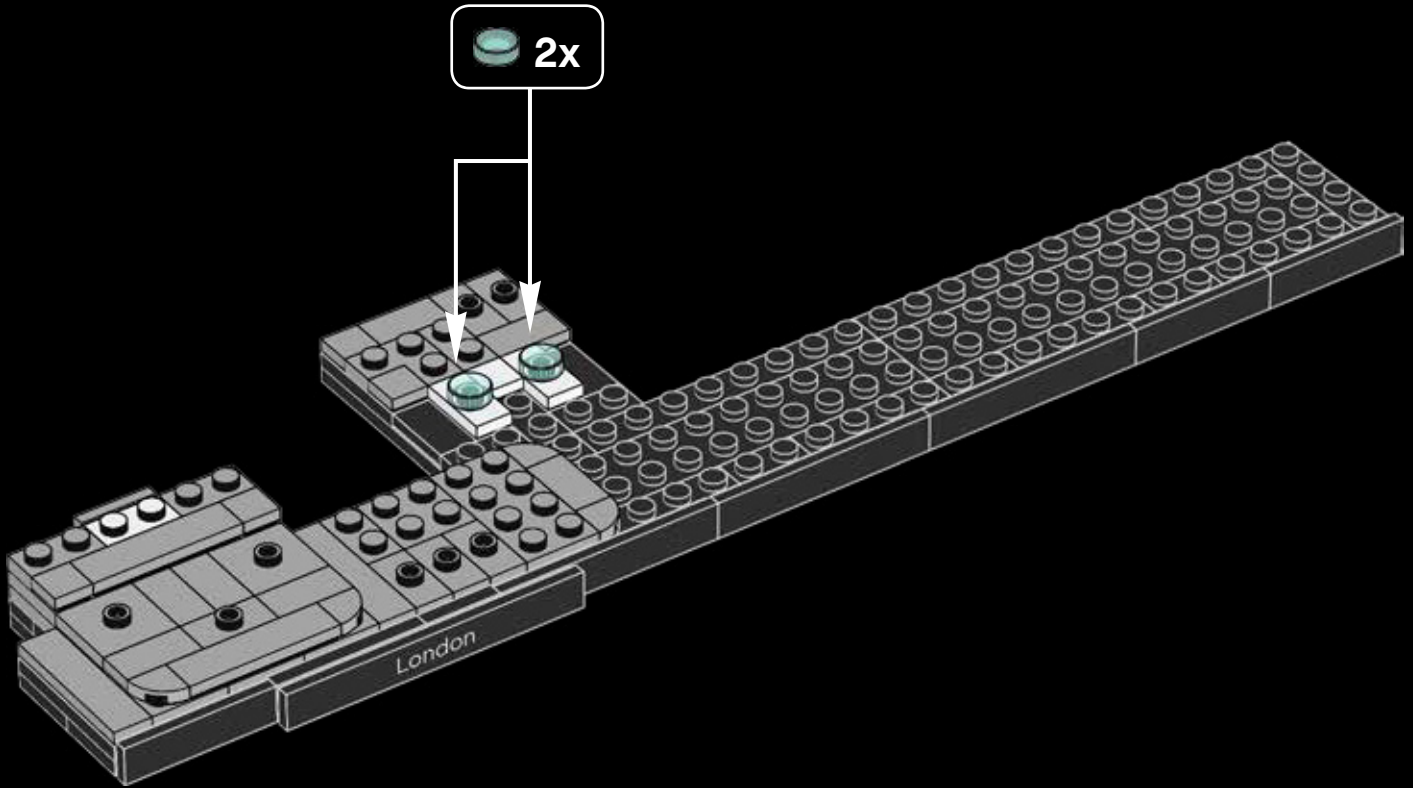



40x

29

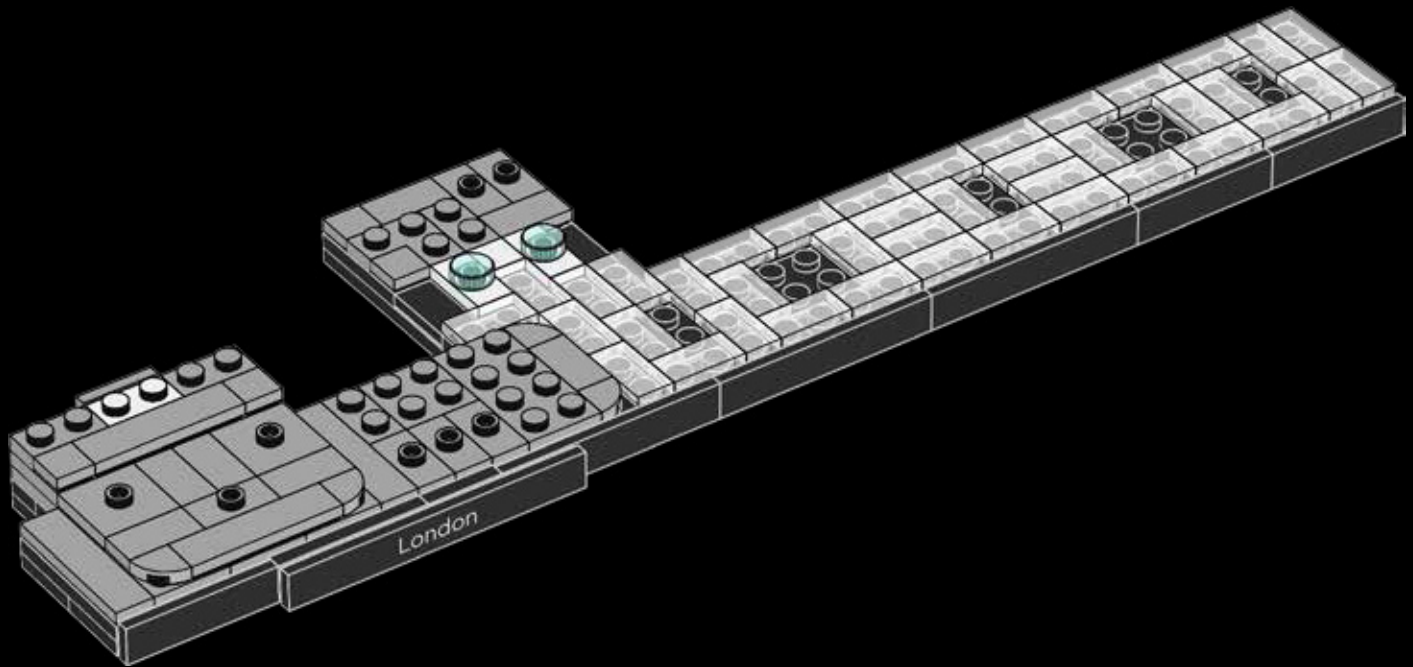



30

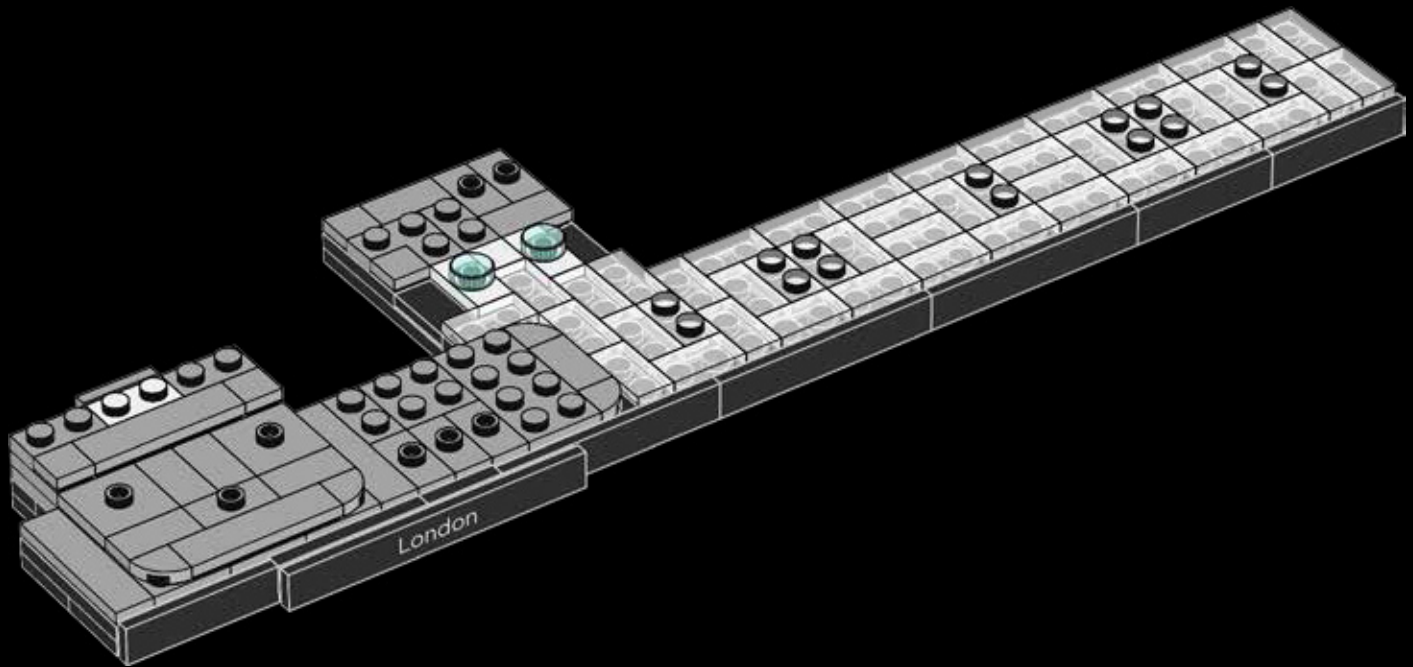



2x

31

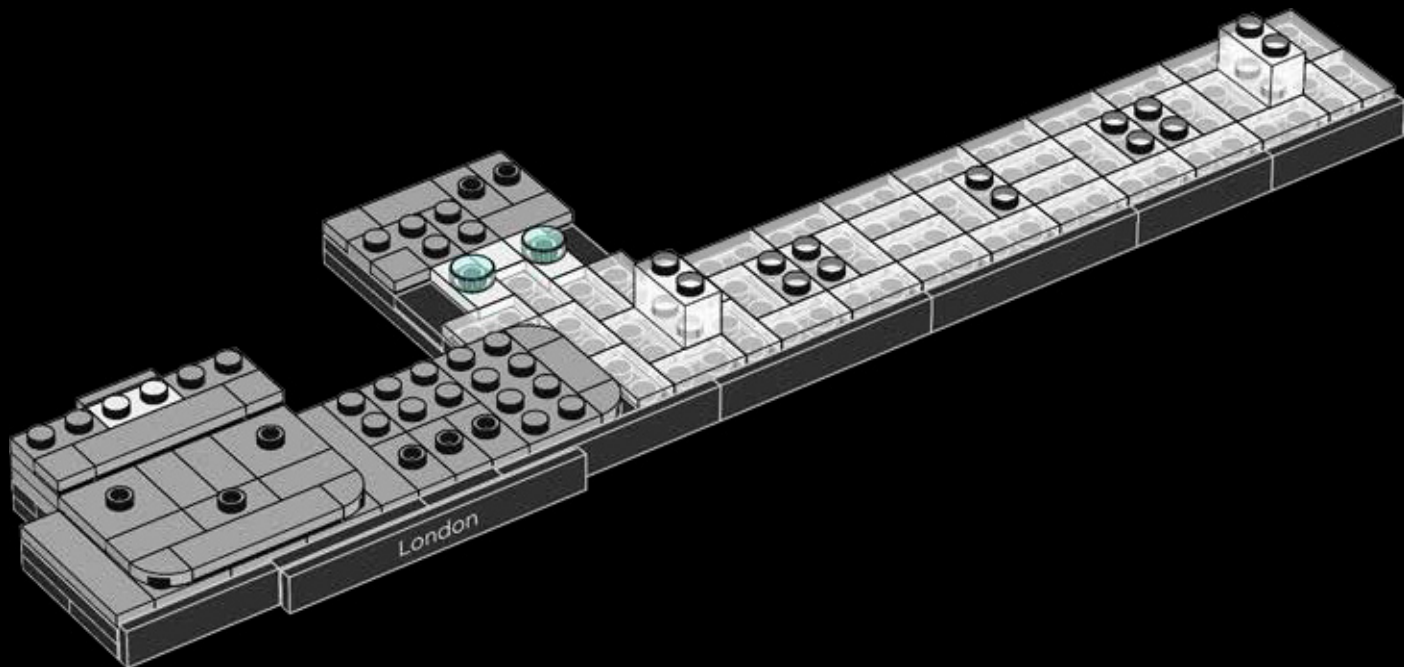



# 32

1



2



3



4

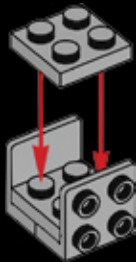

5



2x

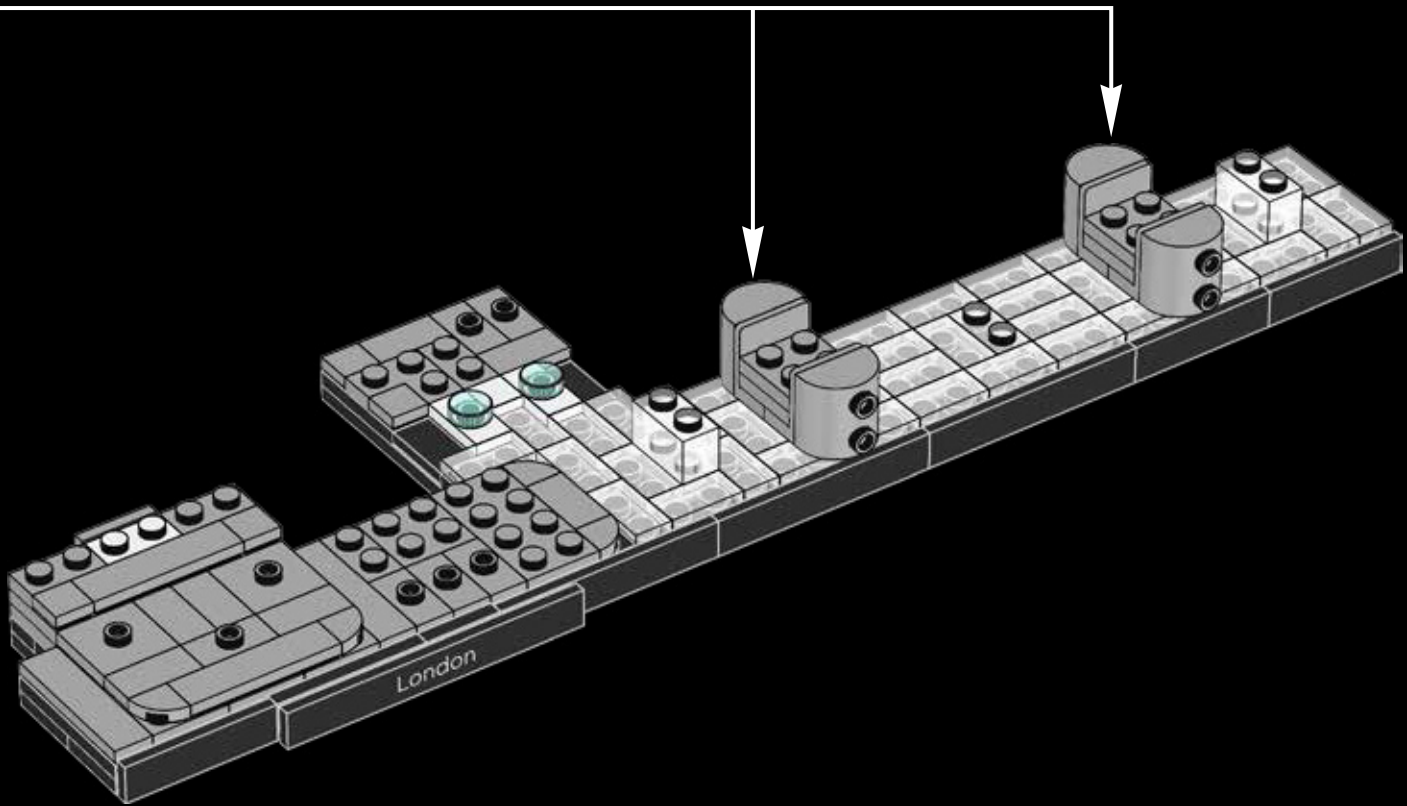



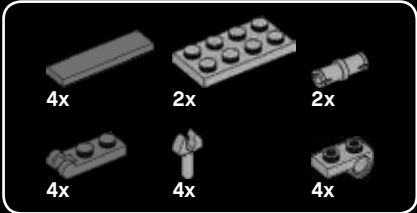

# 33

1



2



3

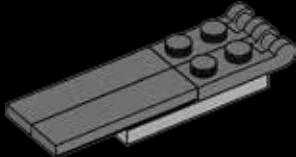

1



2



3



4

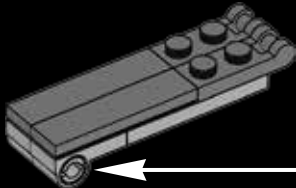

5

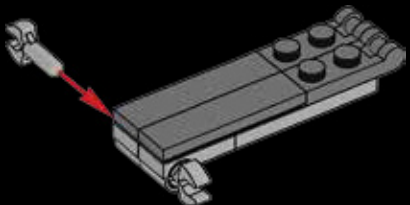

2x

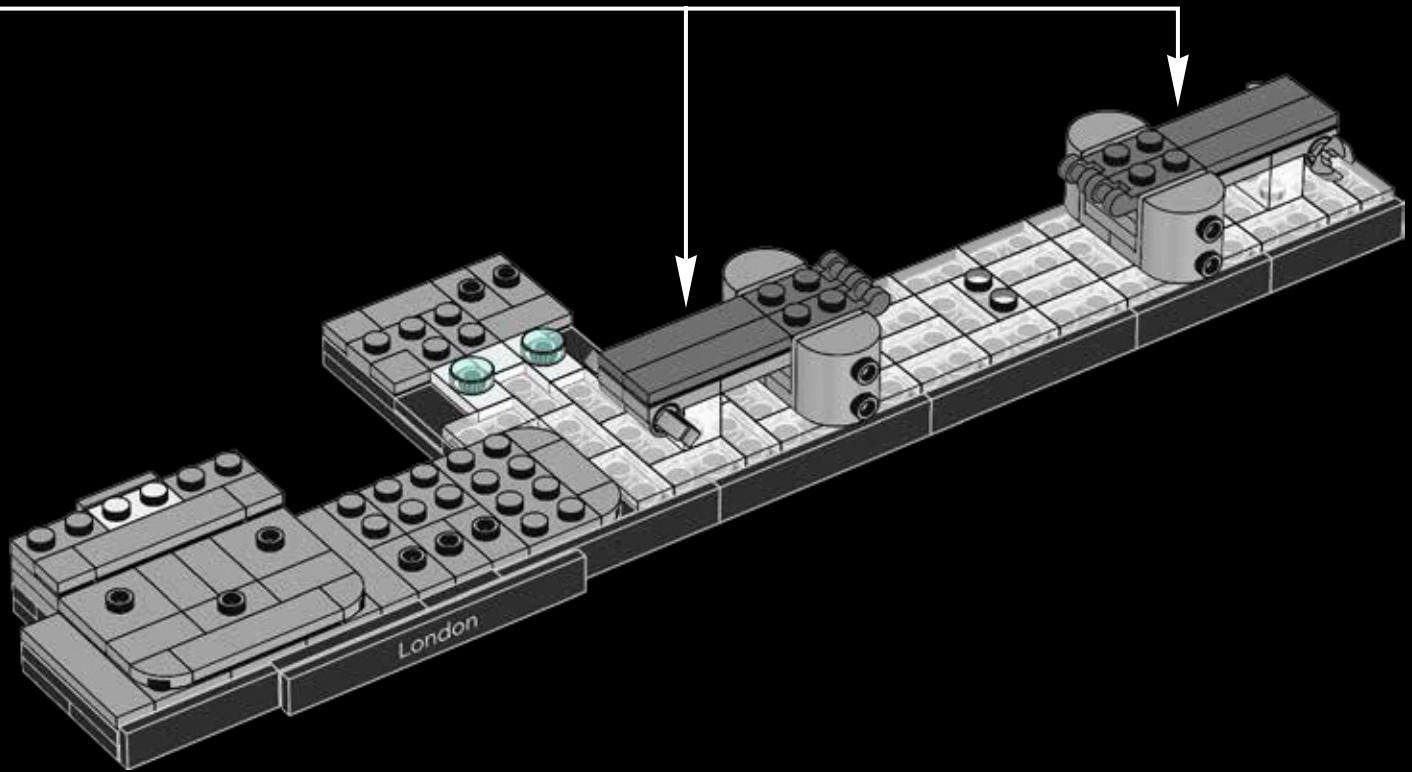



34

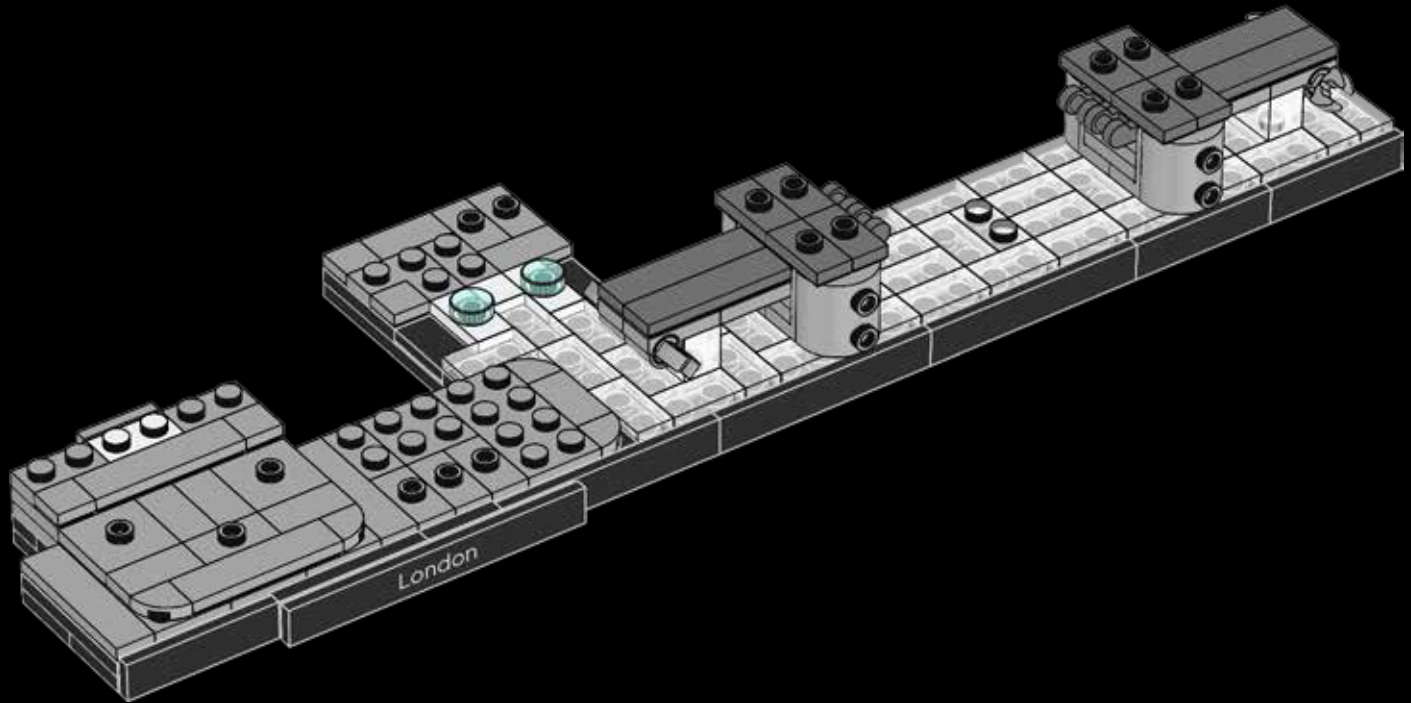



35

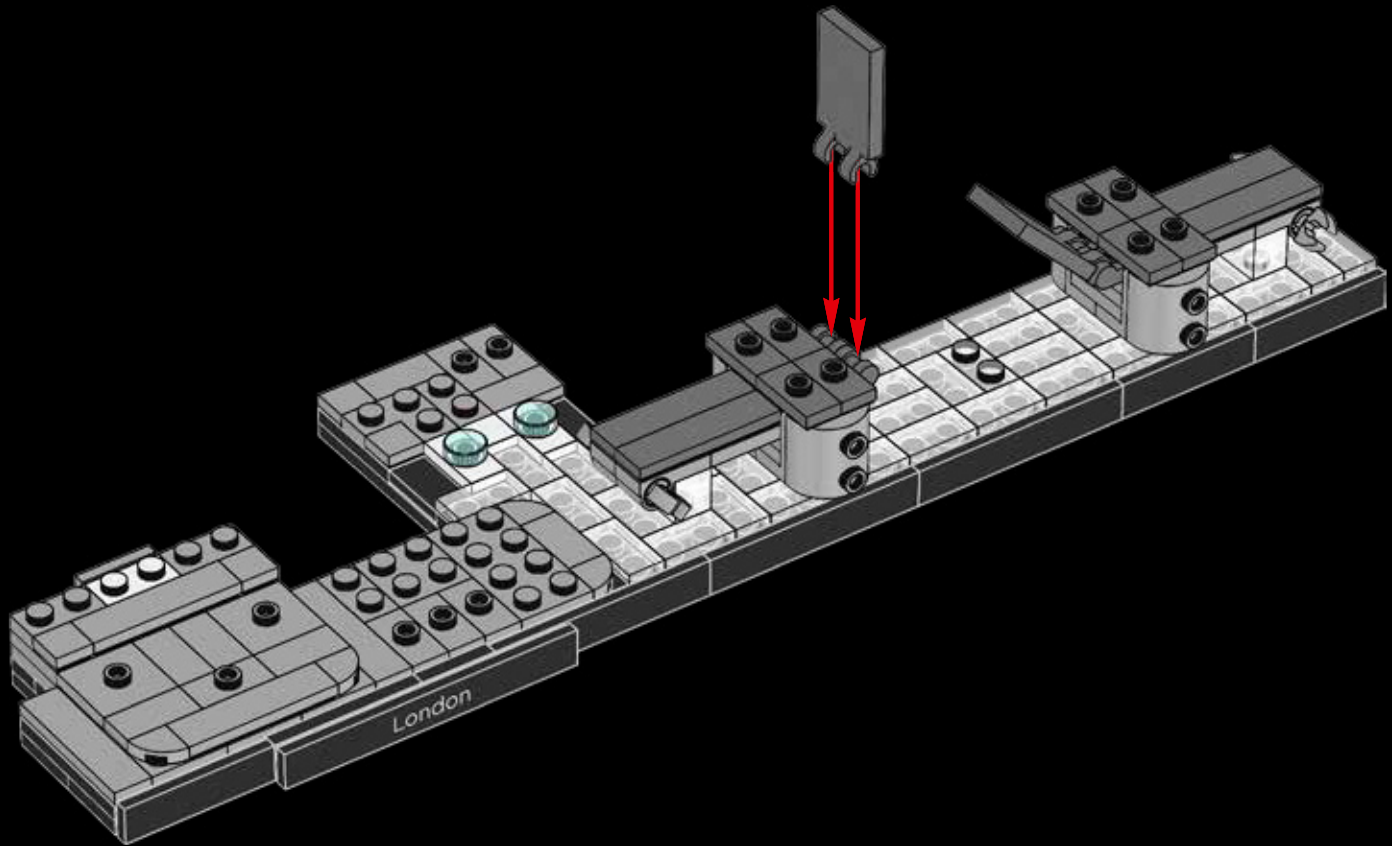

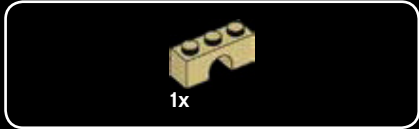

**36**



**37**



**38**



**39**

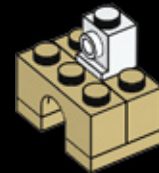



1x



2x

# 40



1x

# 41



1x

# 42



2x



1x

# 43





44



45



46



47



48

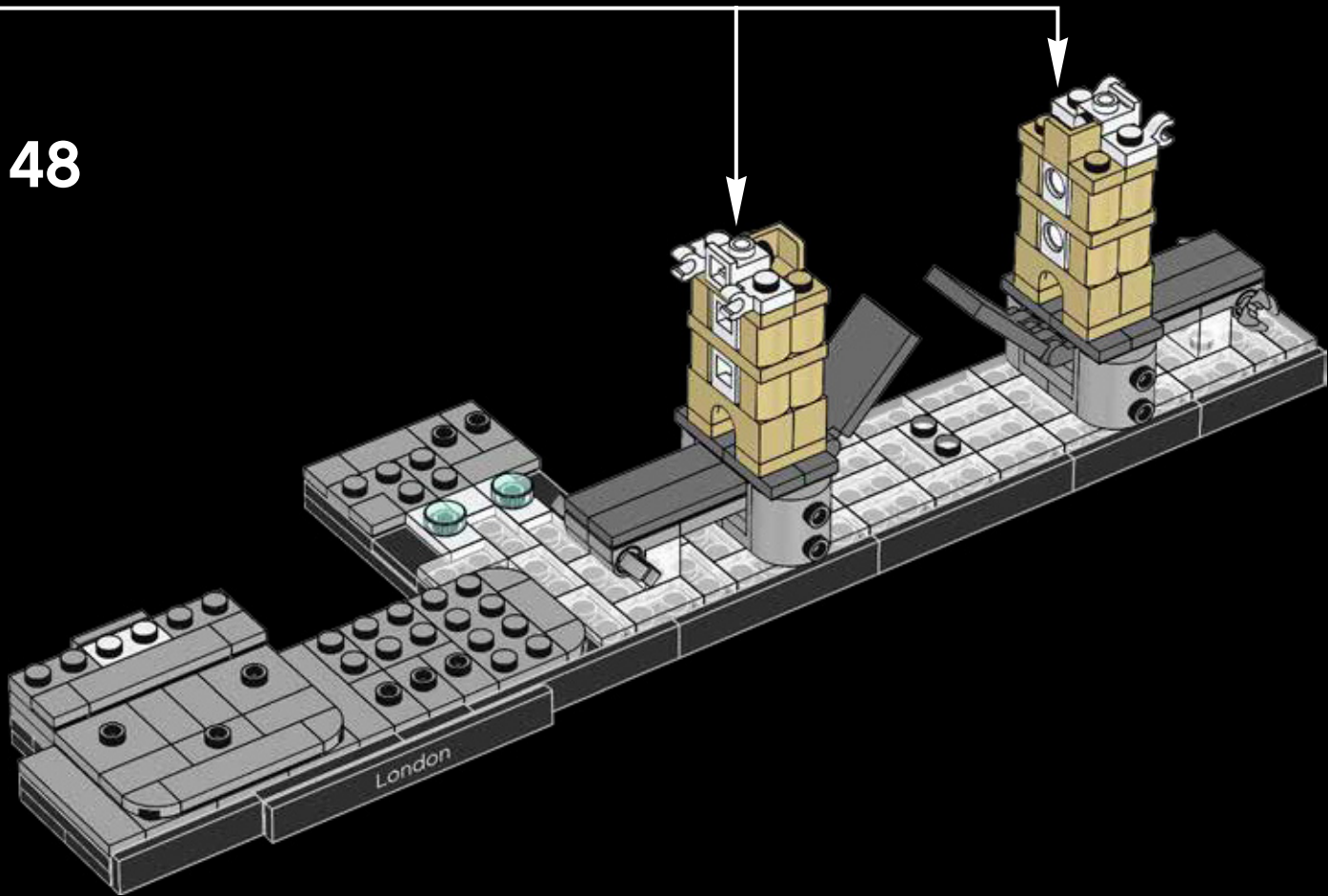



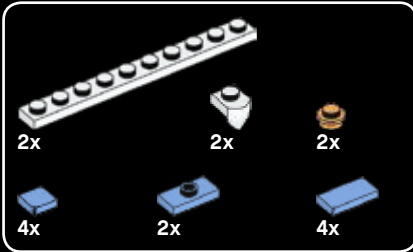
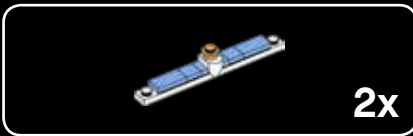

# 49

1

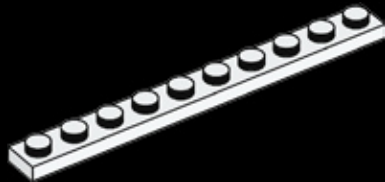

2

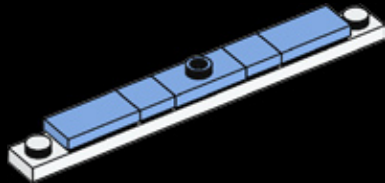

3

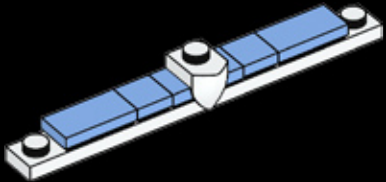

4

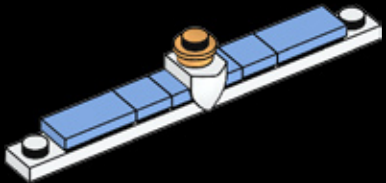

2x

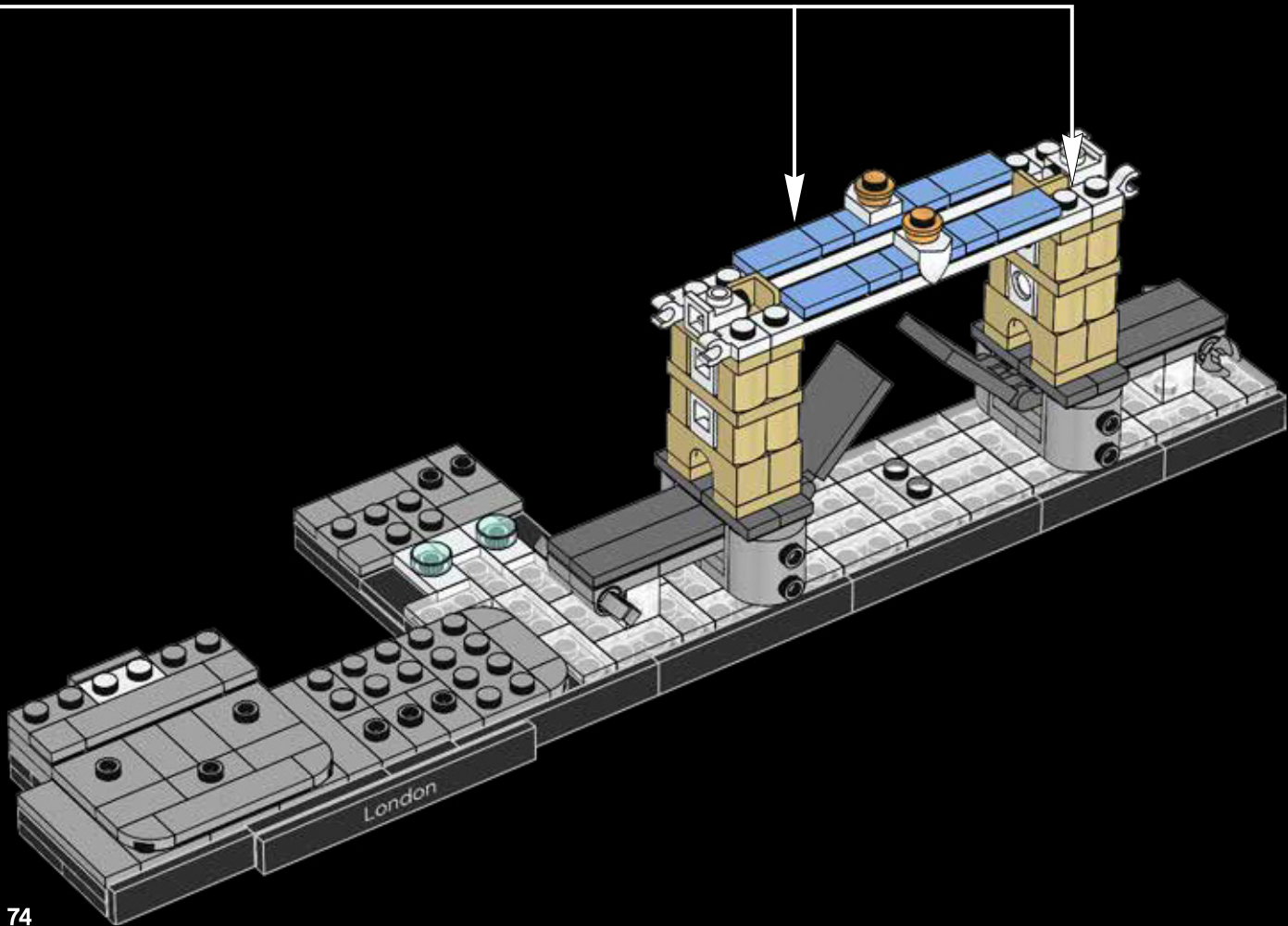



8x

50

The high-level walkways were designed so that the public could still cross the bridge when it was raised.

Les passerelles du niveau supérieur ont été conçues de façon à ce que les piétons puissent traverser le pont même quand il est soulevé.

Las pasarelas elevadas se diseñaron para que la gente pudiera cruzar el río aunque las vías estuvieran levantadas.

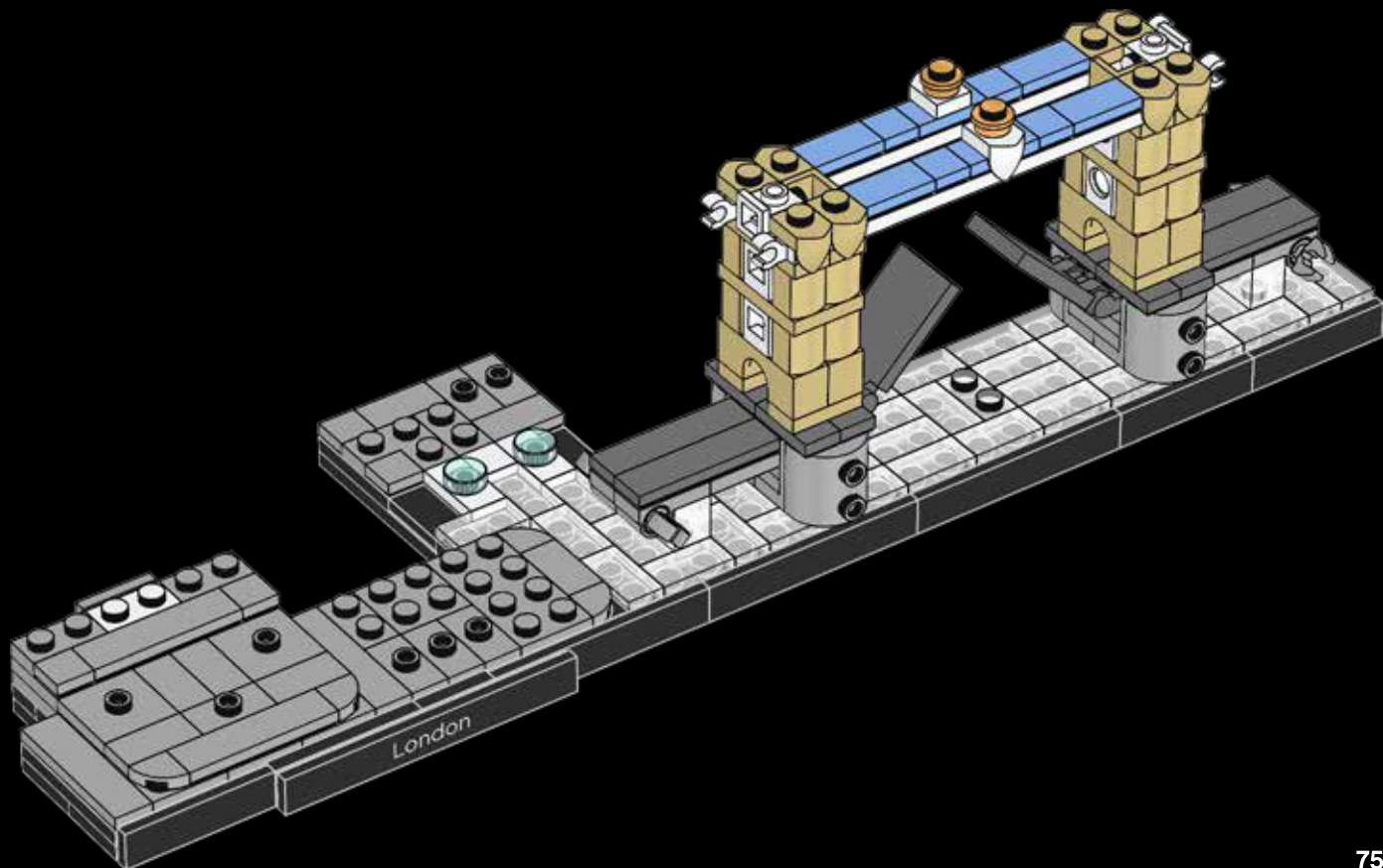



4x



4x

# 51

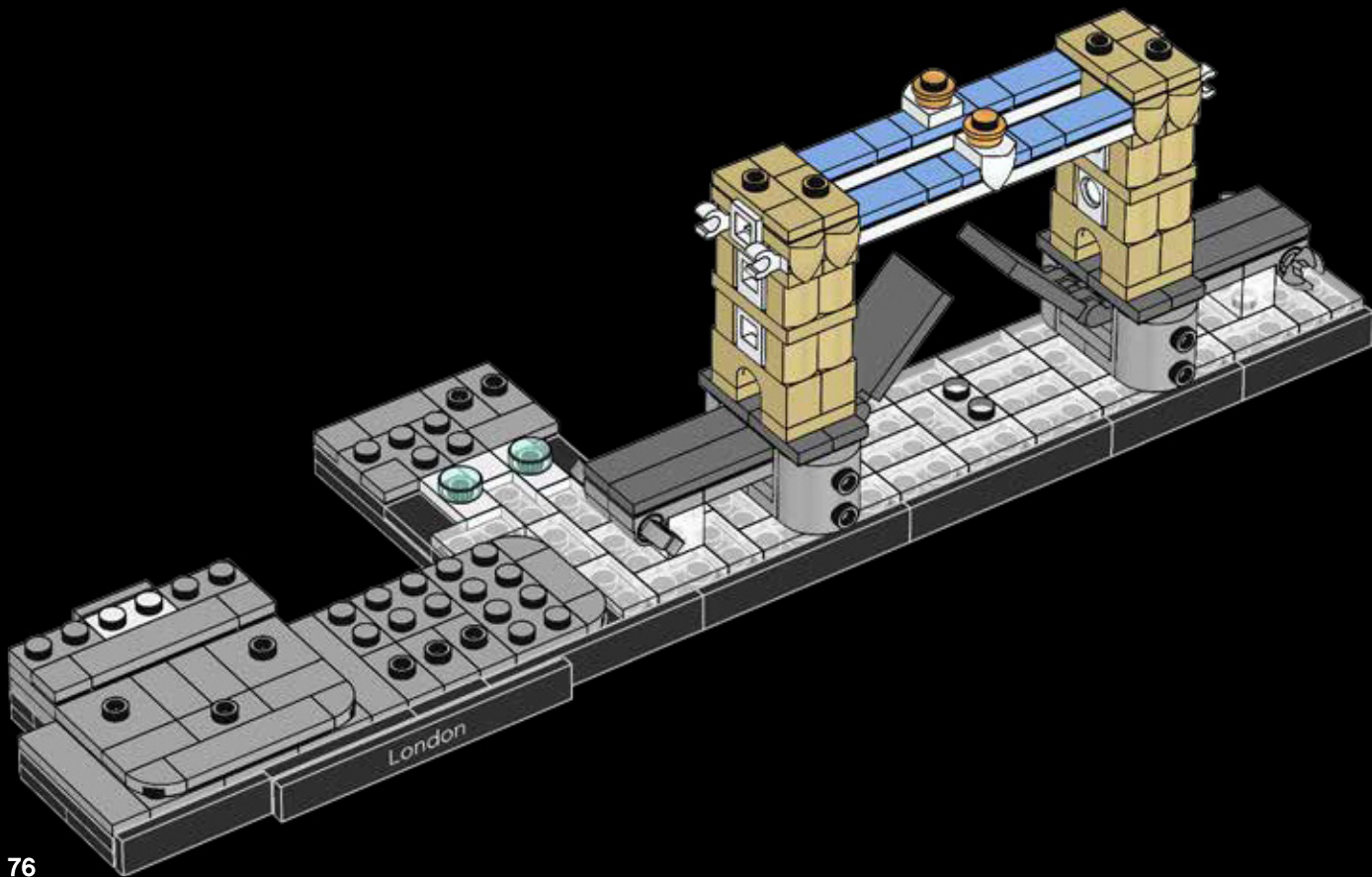

76



52

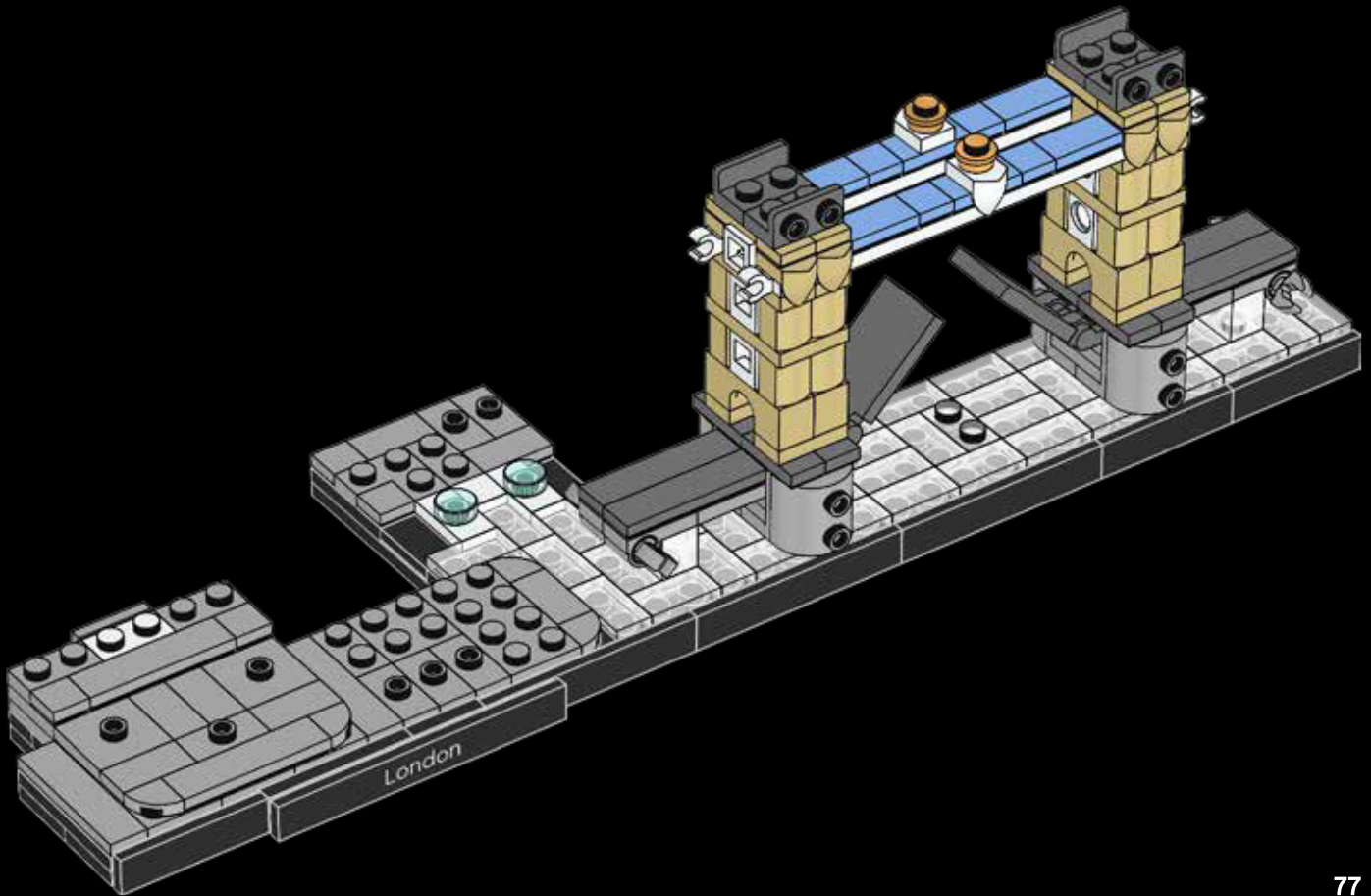



4x

53

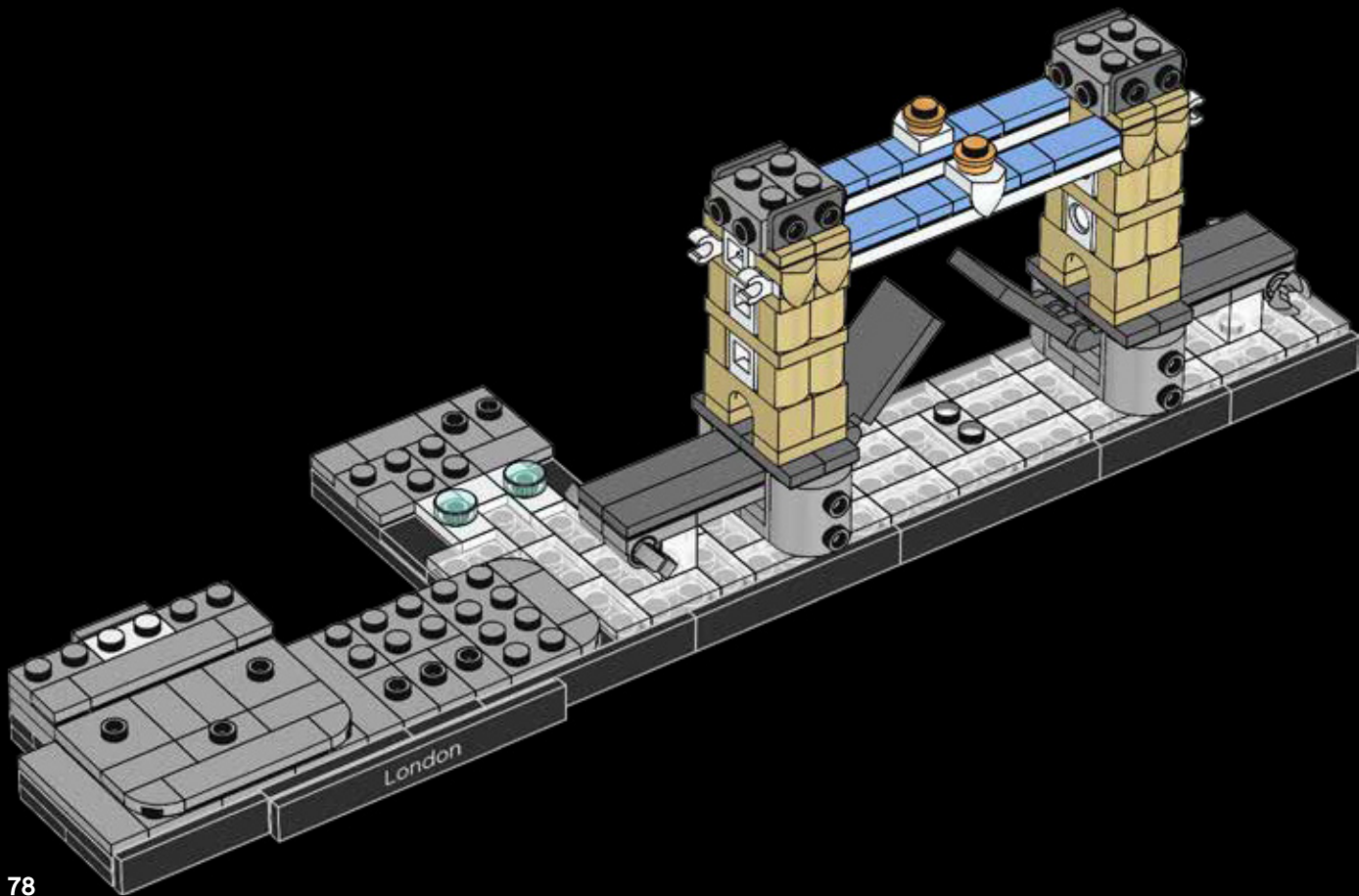



4x

54

The bridge's lifting mechanism was originally powered by steam, but is now driven by oil and electricity.

Le mécanisme de soulèvement du pont était actionné à l'origine par la vapeur, mais il est maintenant actionné par l'huile et l'électricité.

Originalmente, el mecanismo de elevación del puente funcionaba a vapor. Hoy funciona con aceite y electricidad.

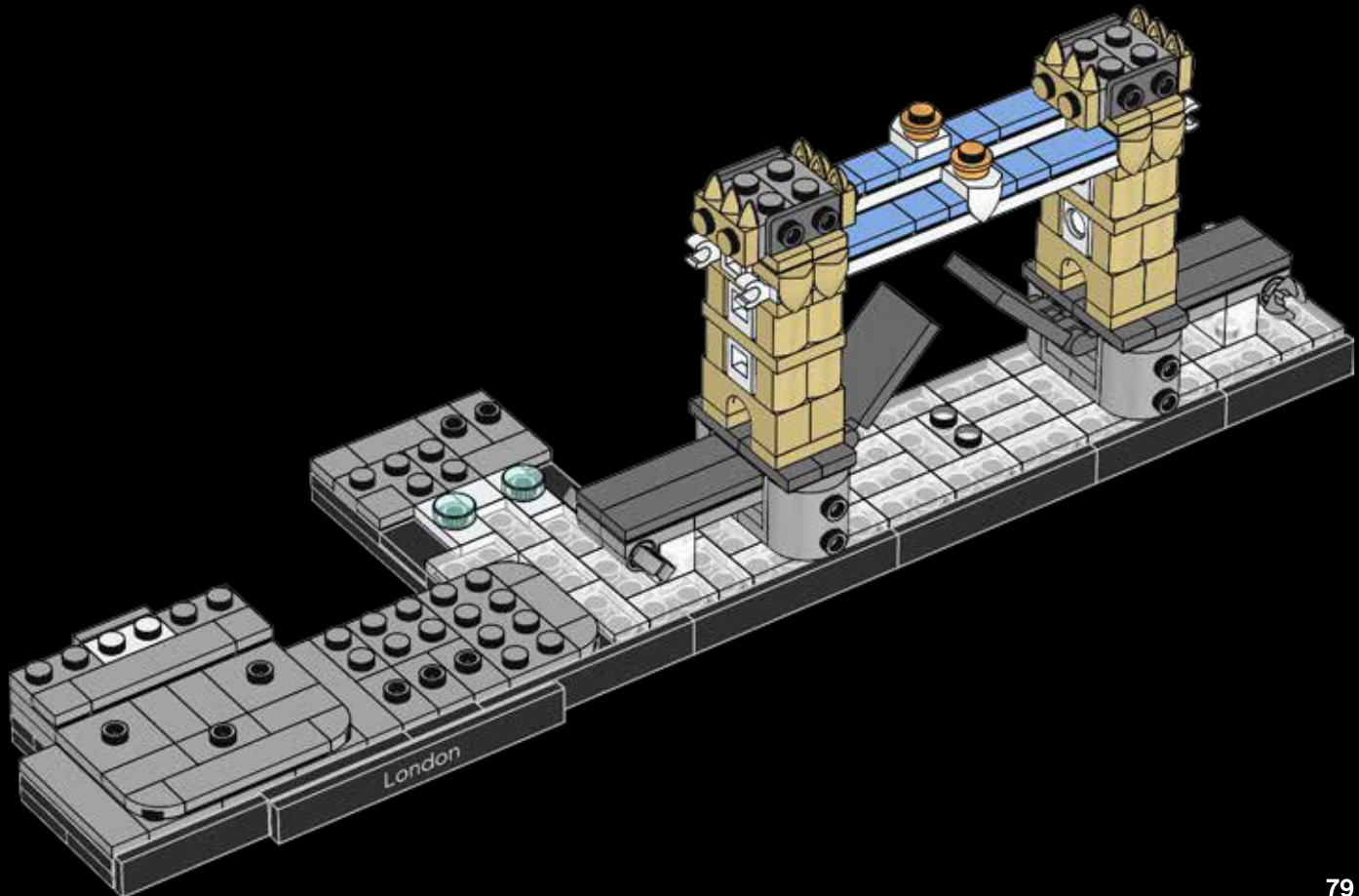



8x

55

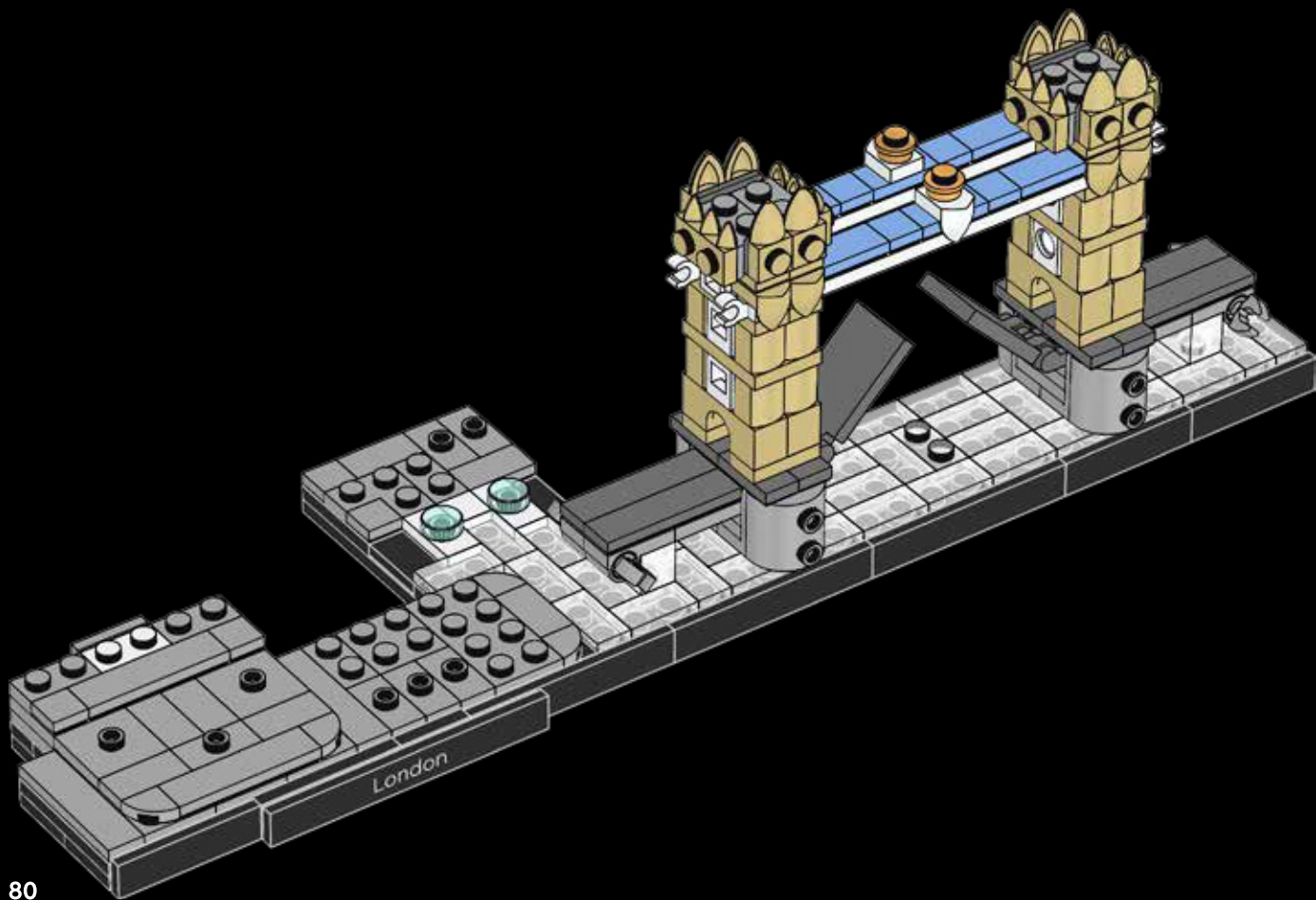





56

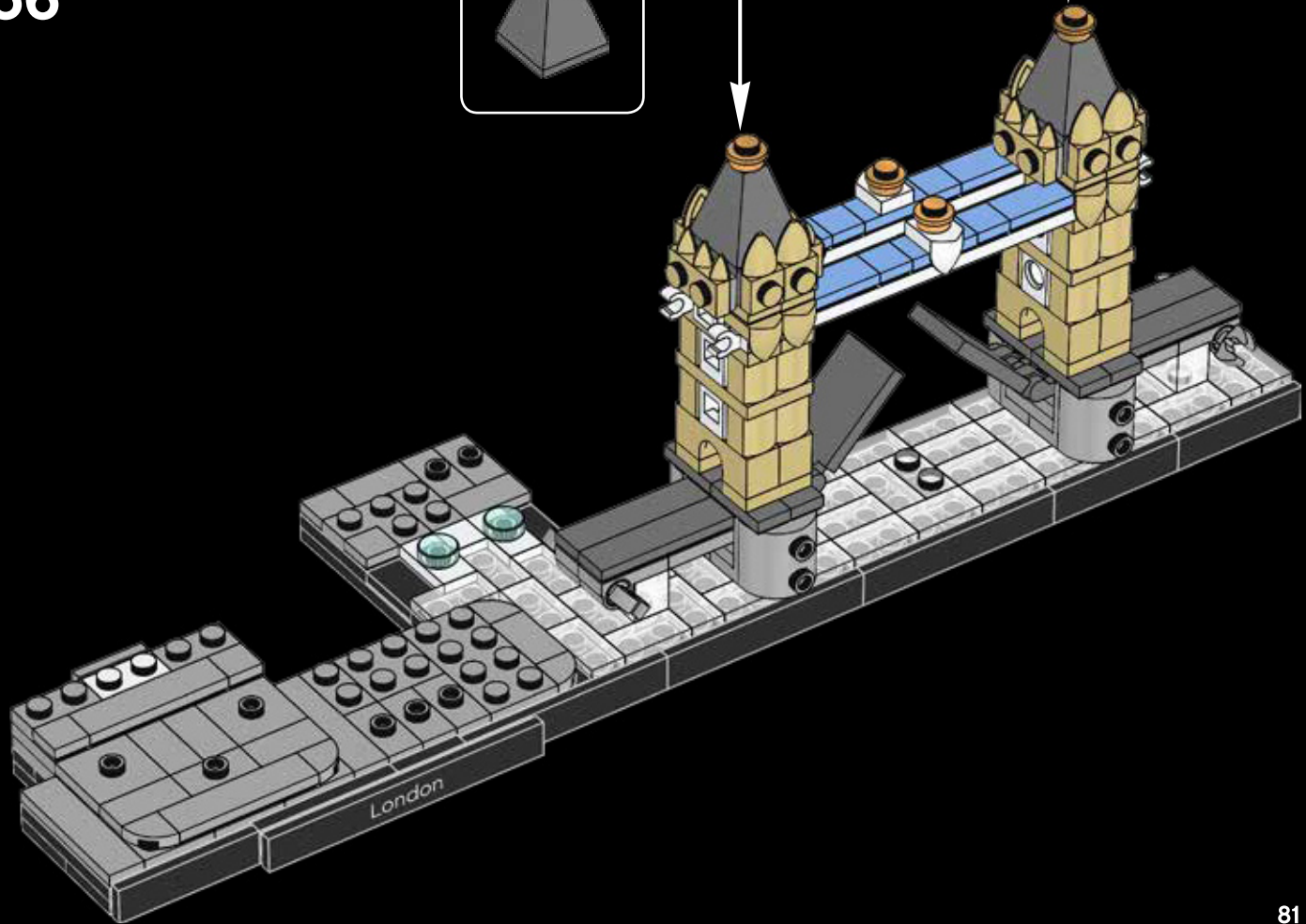
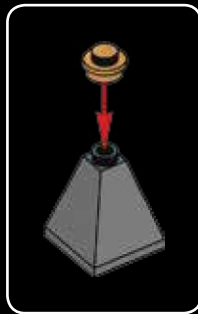



57

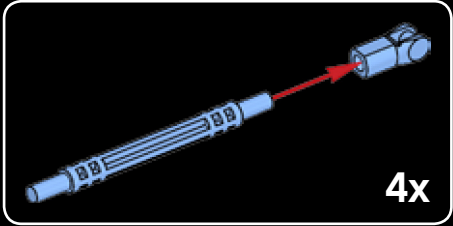
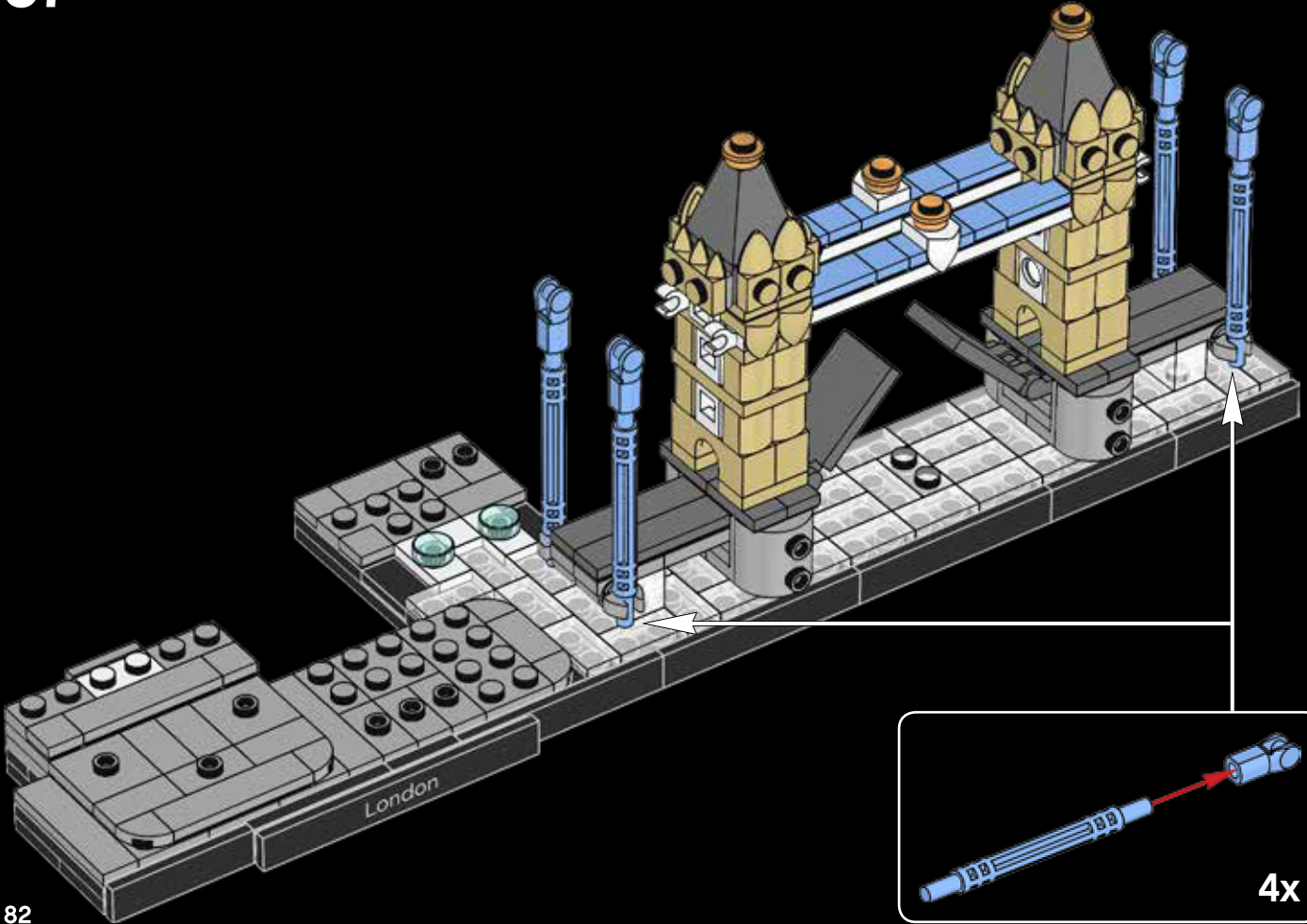



58

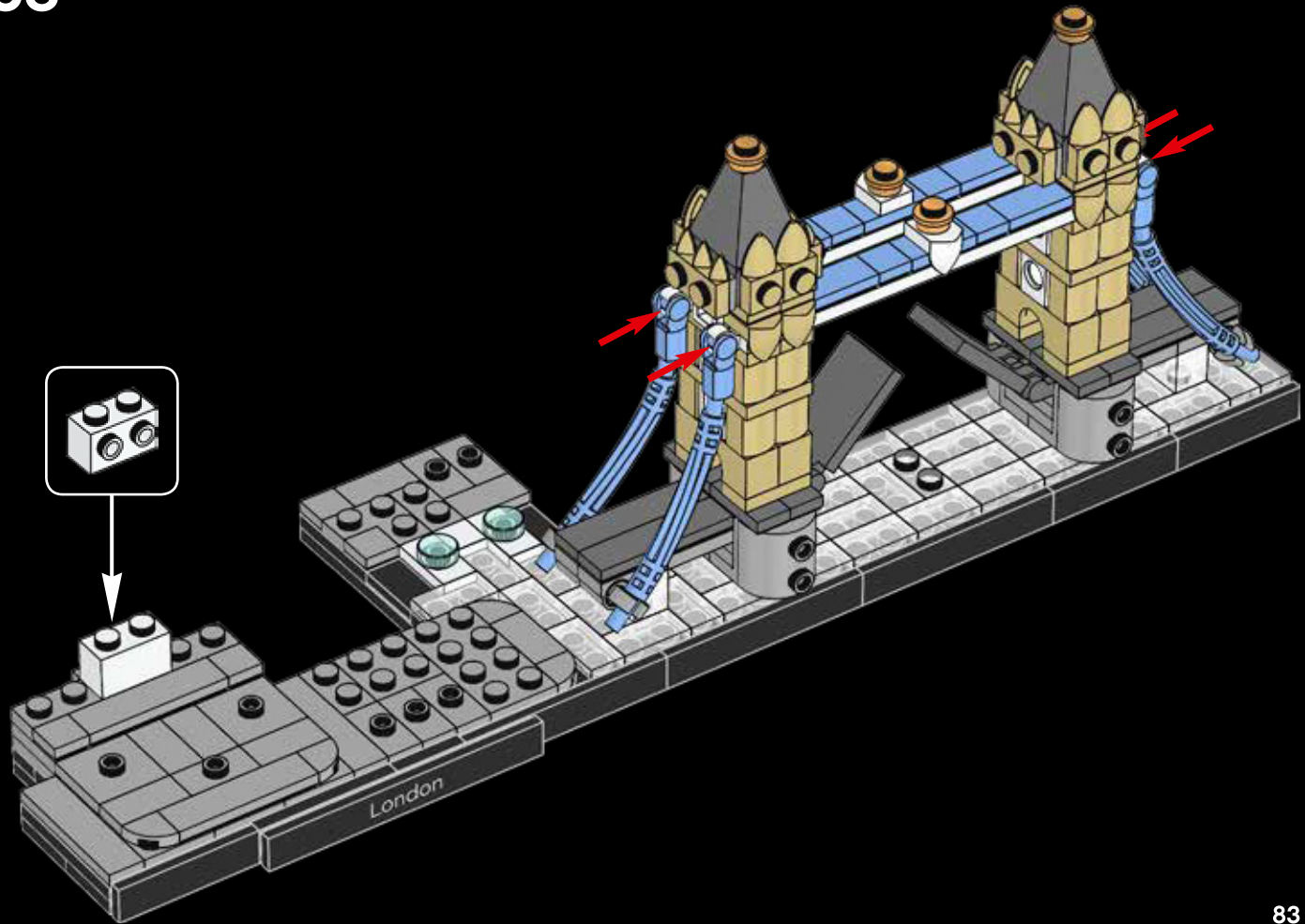



6x

59

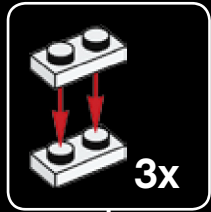

3x

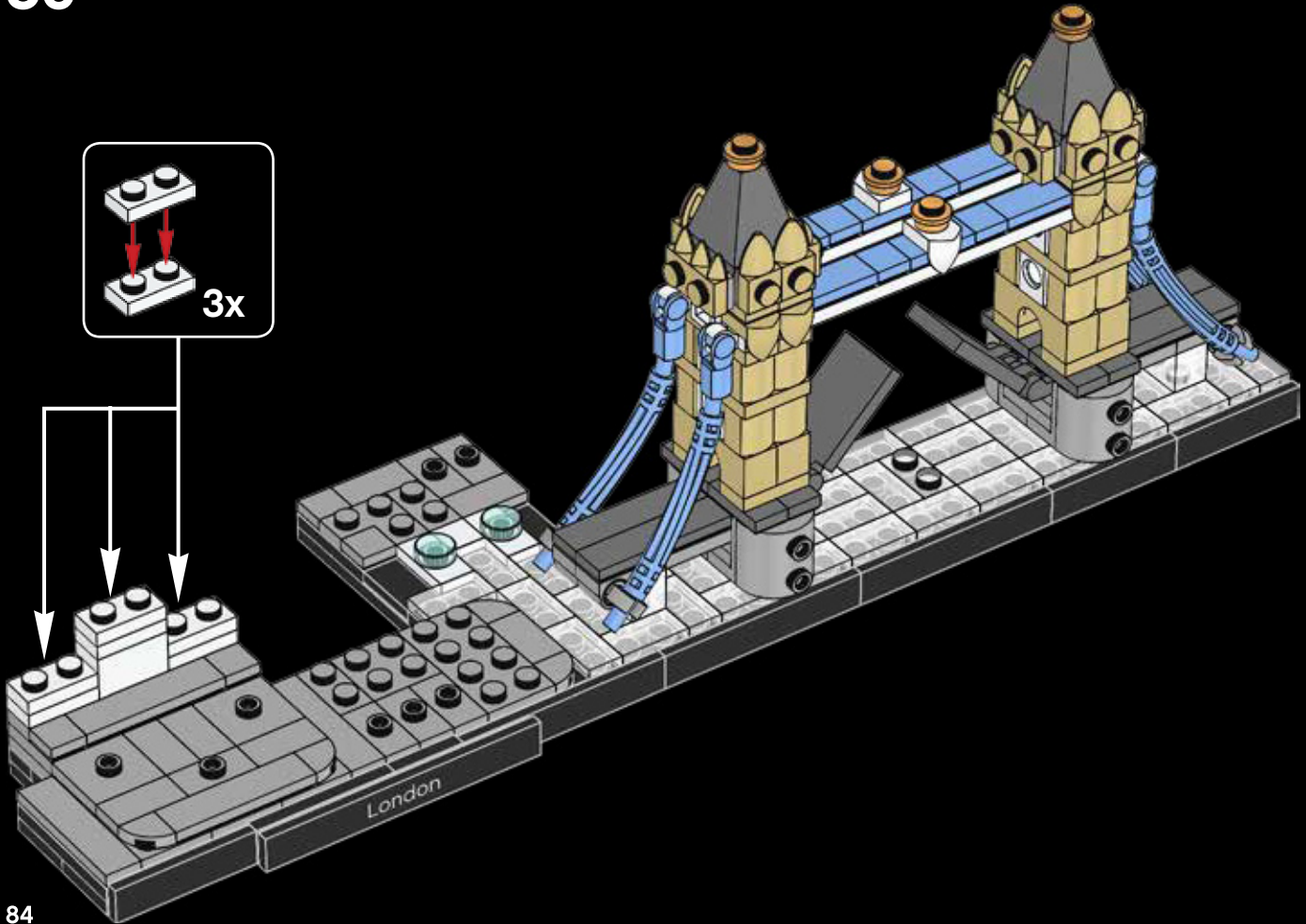

London



2x

60

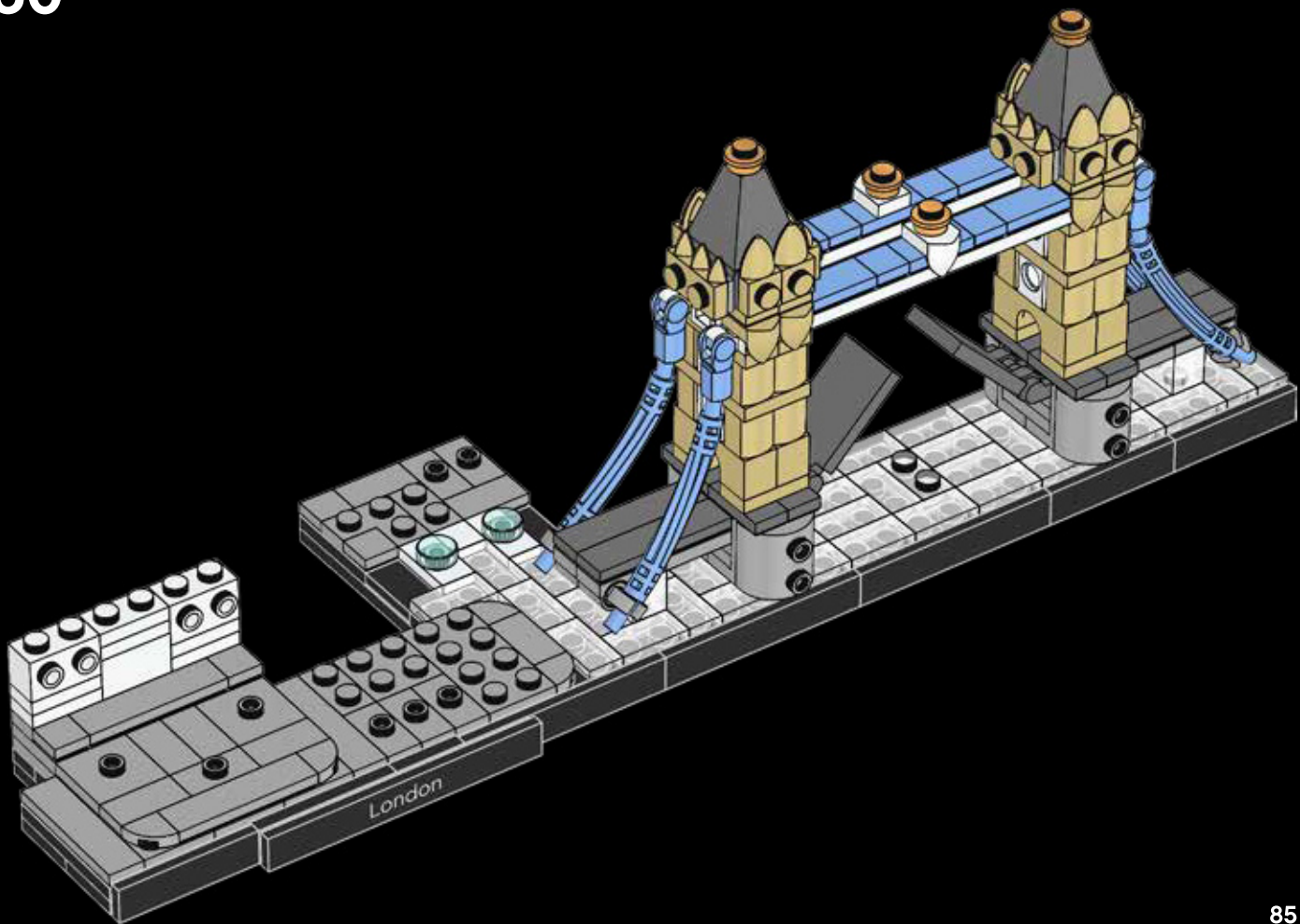



61

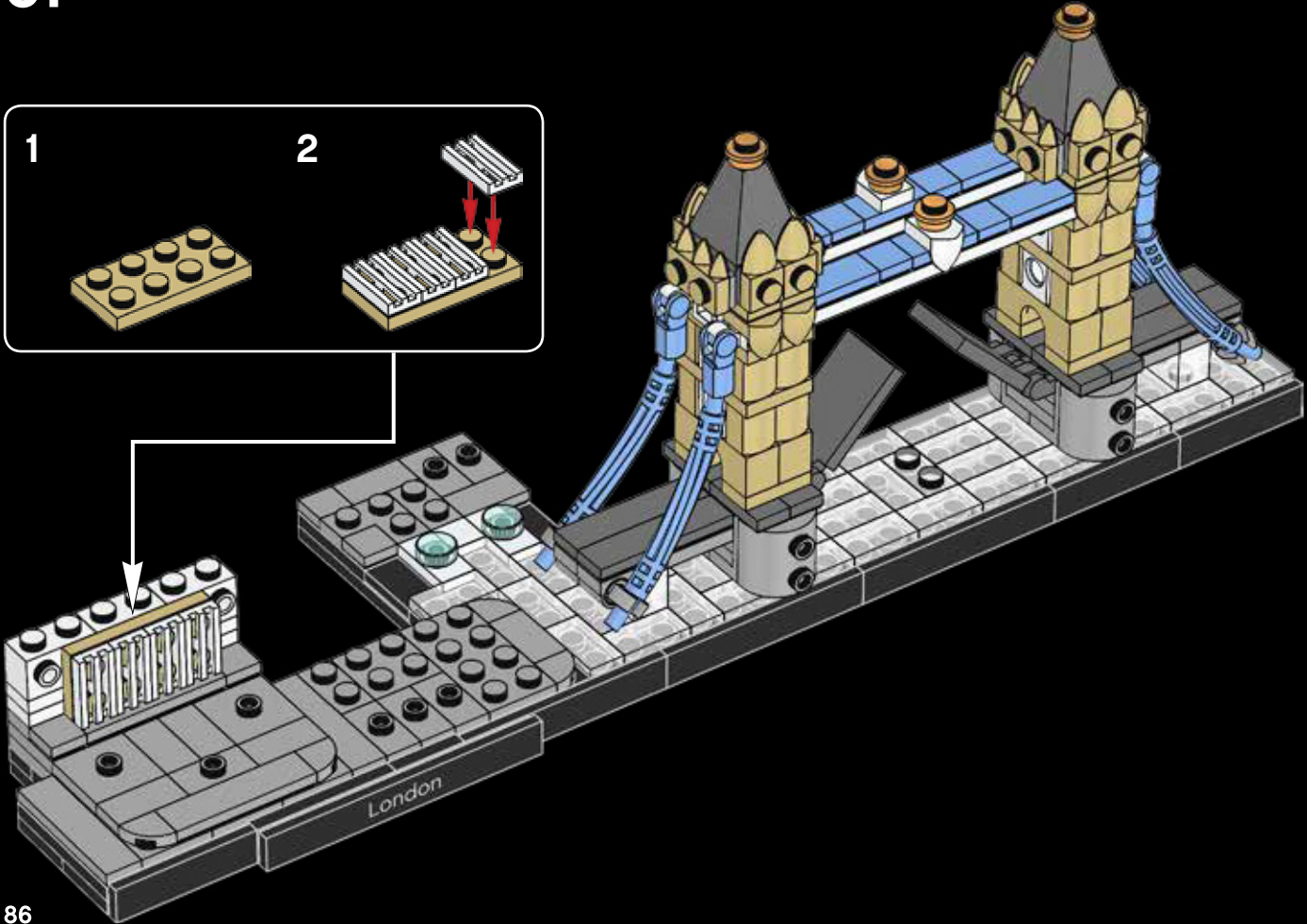
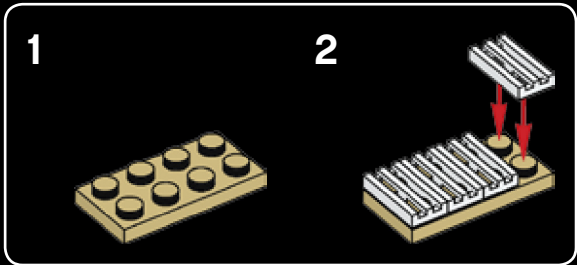



62

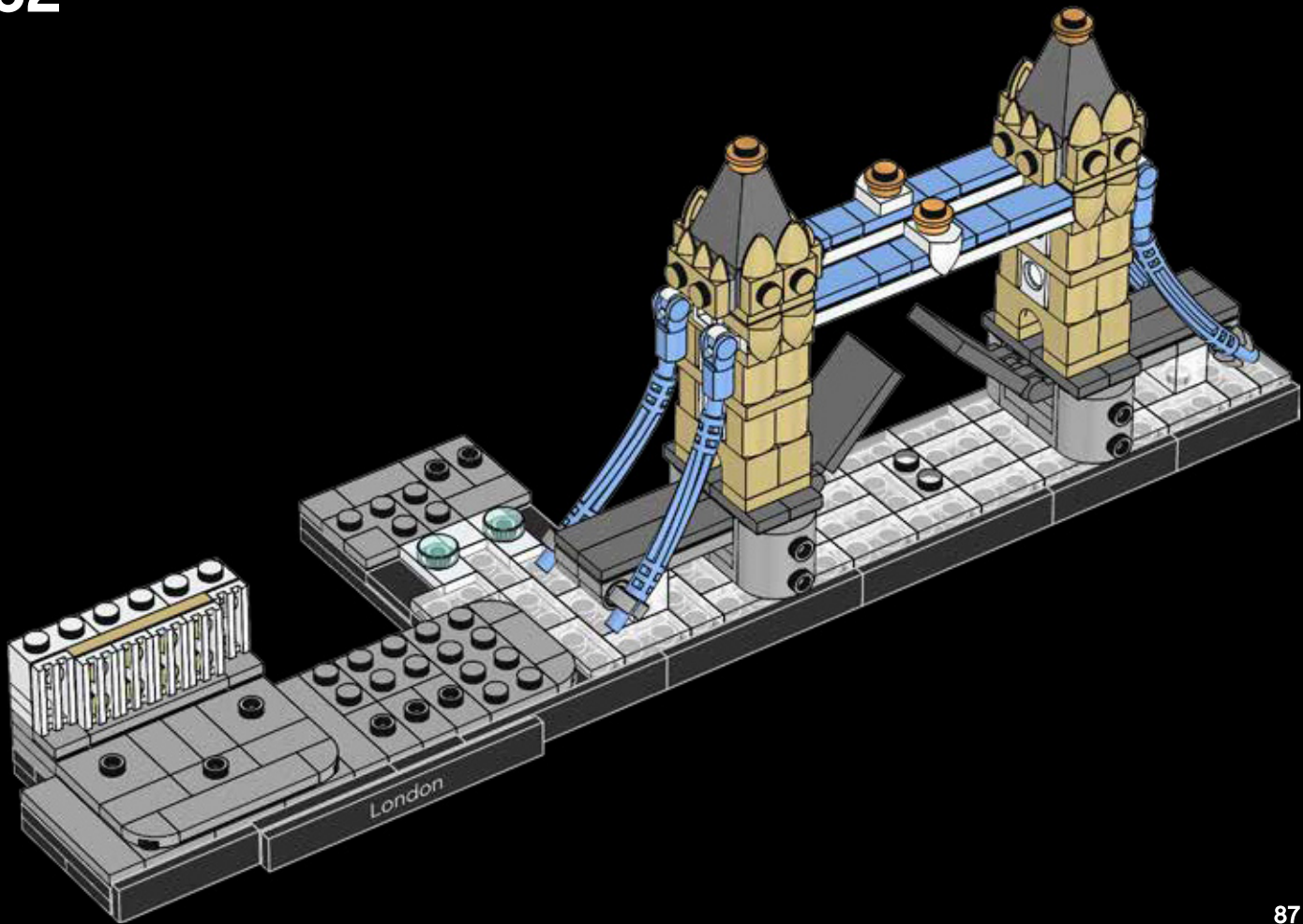



63

1



2

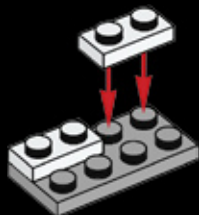

3

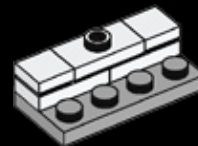

4

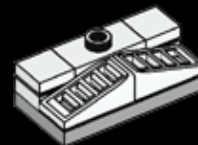



The National Gallery stands on the former site of the Kings Mews, the building where the King's horses were stabled.

La National Gallery se tient sur le site des anciennes écuries du roi, le bâtiment qui abritait les chevaux du roi.

La Galería Nacional se construyó sobre los cimientos del Kings Mews, el edificio en el que se encontraban las caballerizas del rey.

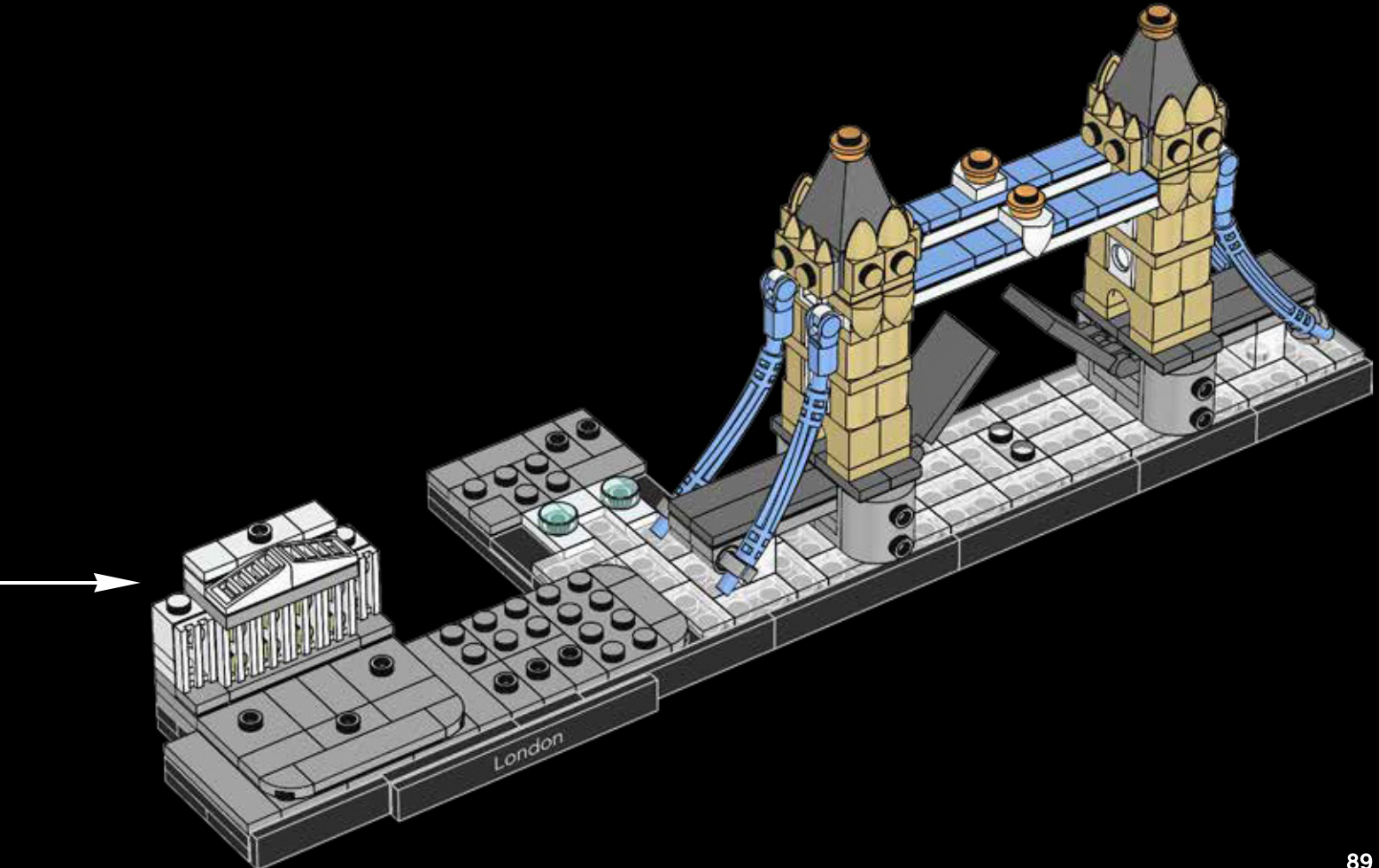



2x

64

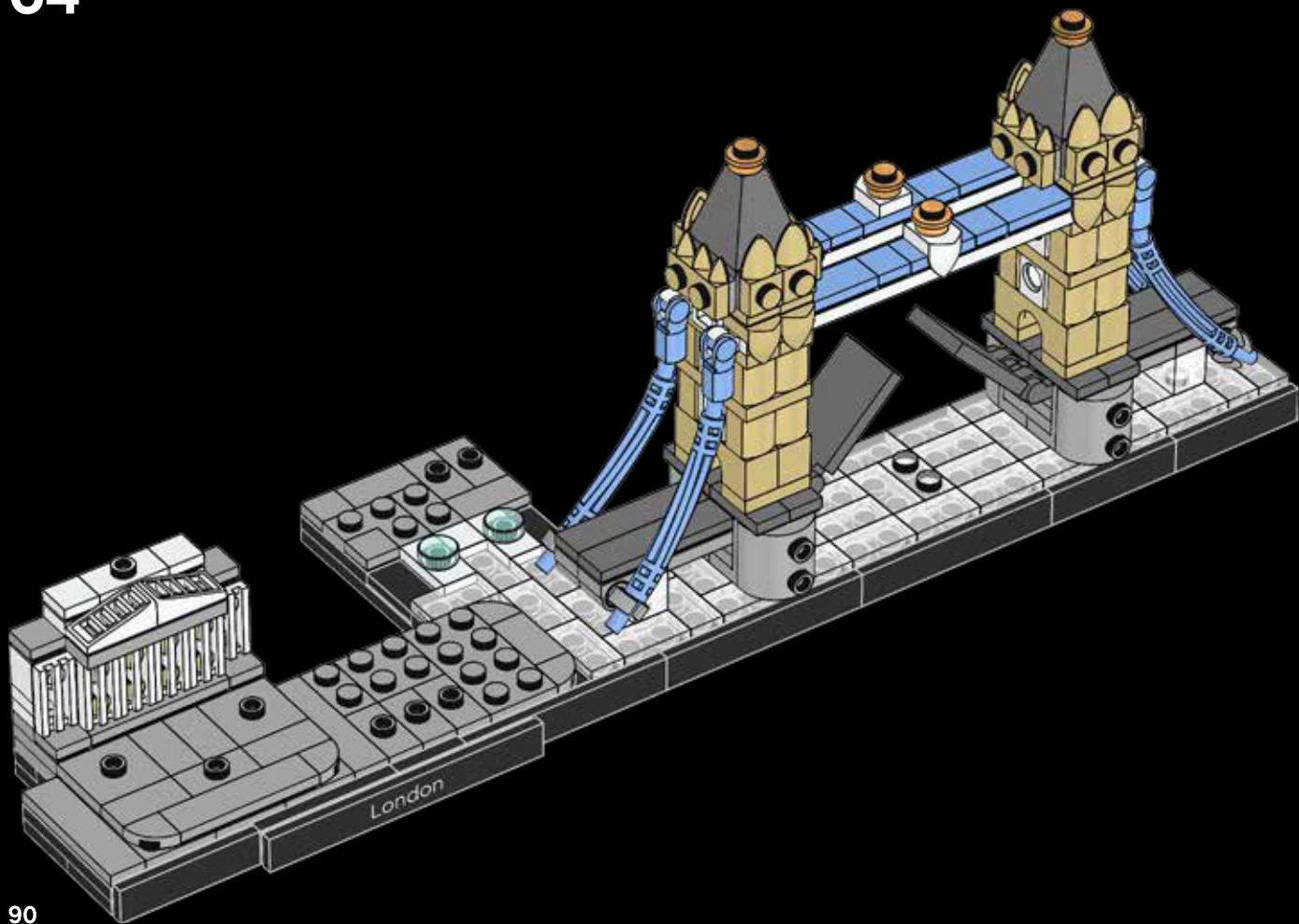



65

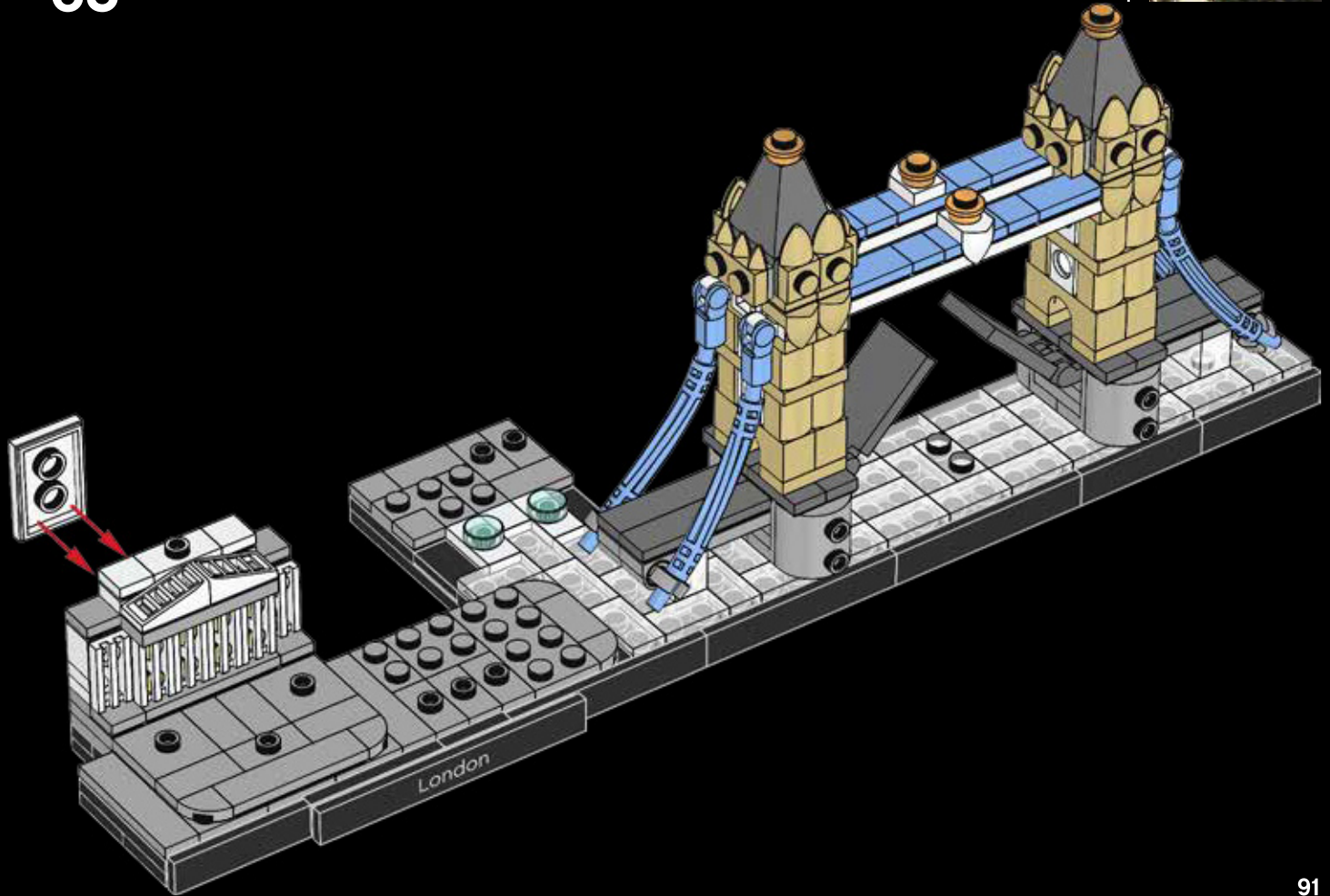

Several new rooms and the impressive dome were added to the building in 1876.

Plusieurs nouvelles salles et le dôme impressionnant furent ajoutés au bâtiment en 1876.

En 1876 se agregaron varias salas y la impresionante cúpula al edificio.



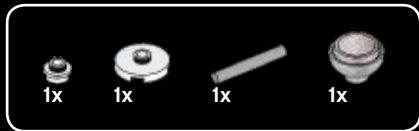

66

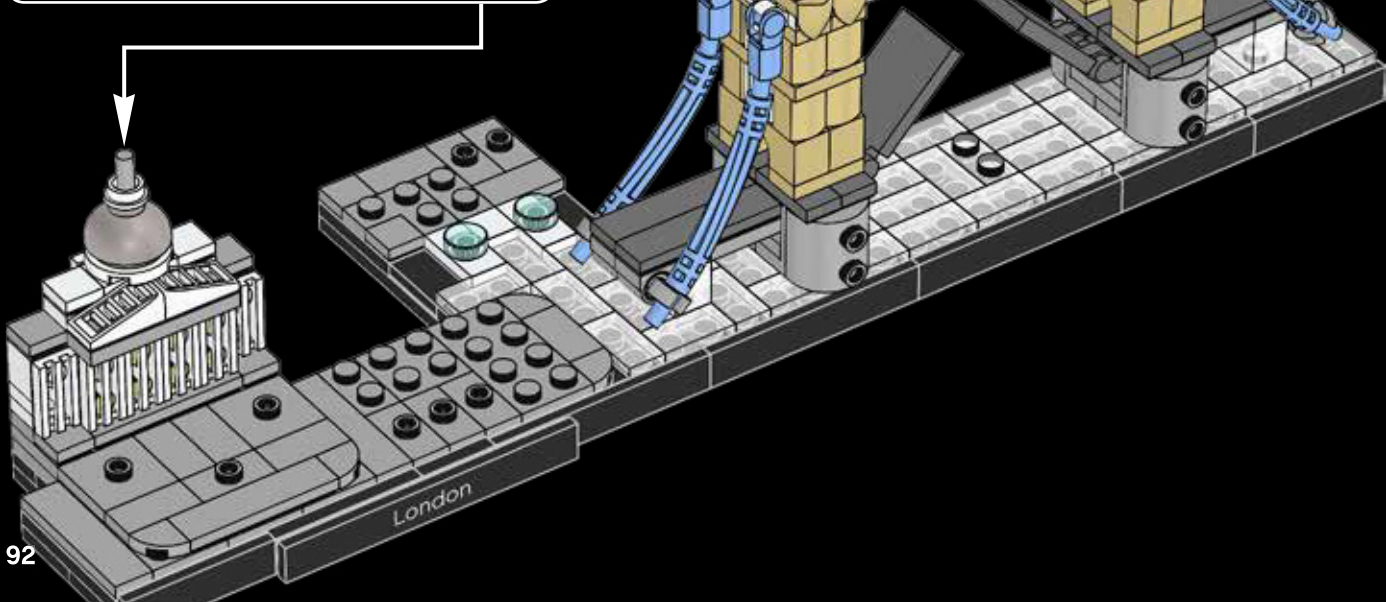
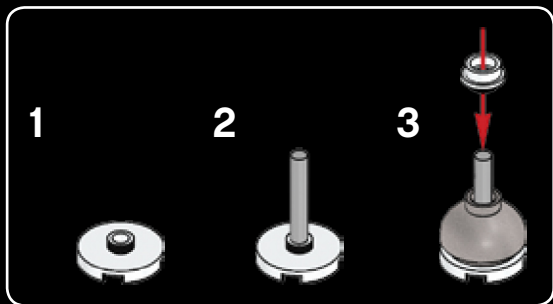

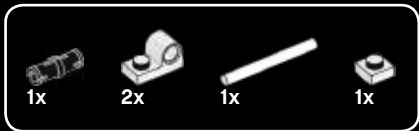

67

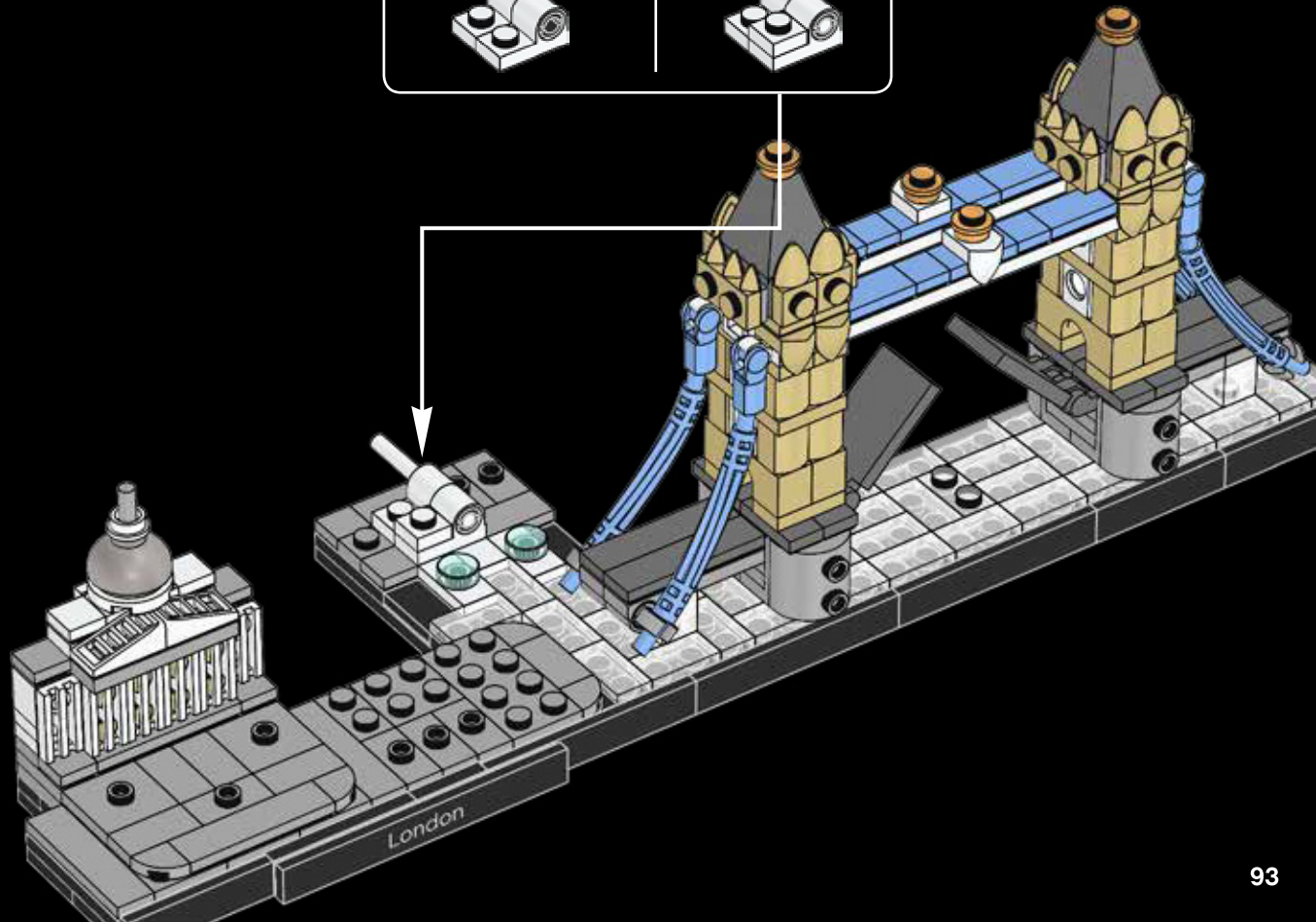
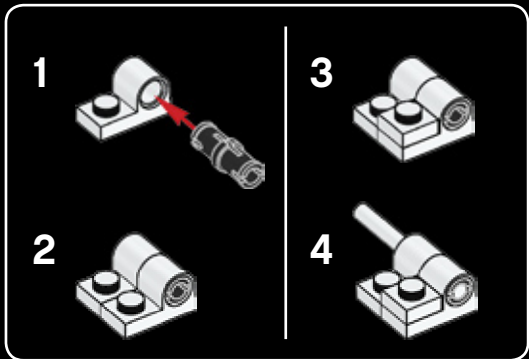



1x



1x

68

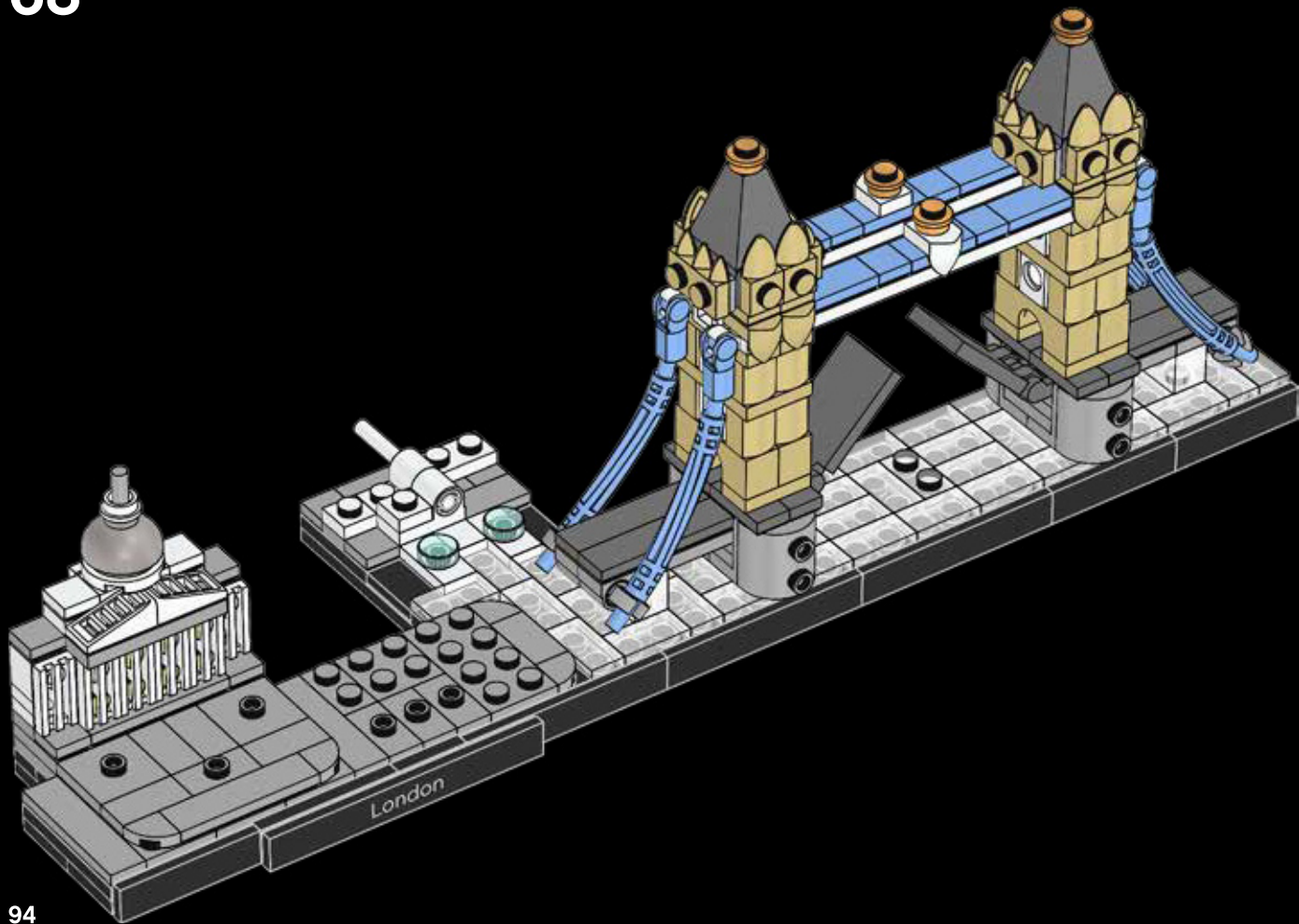



69

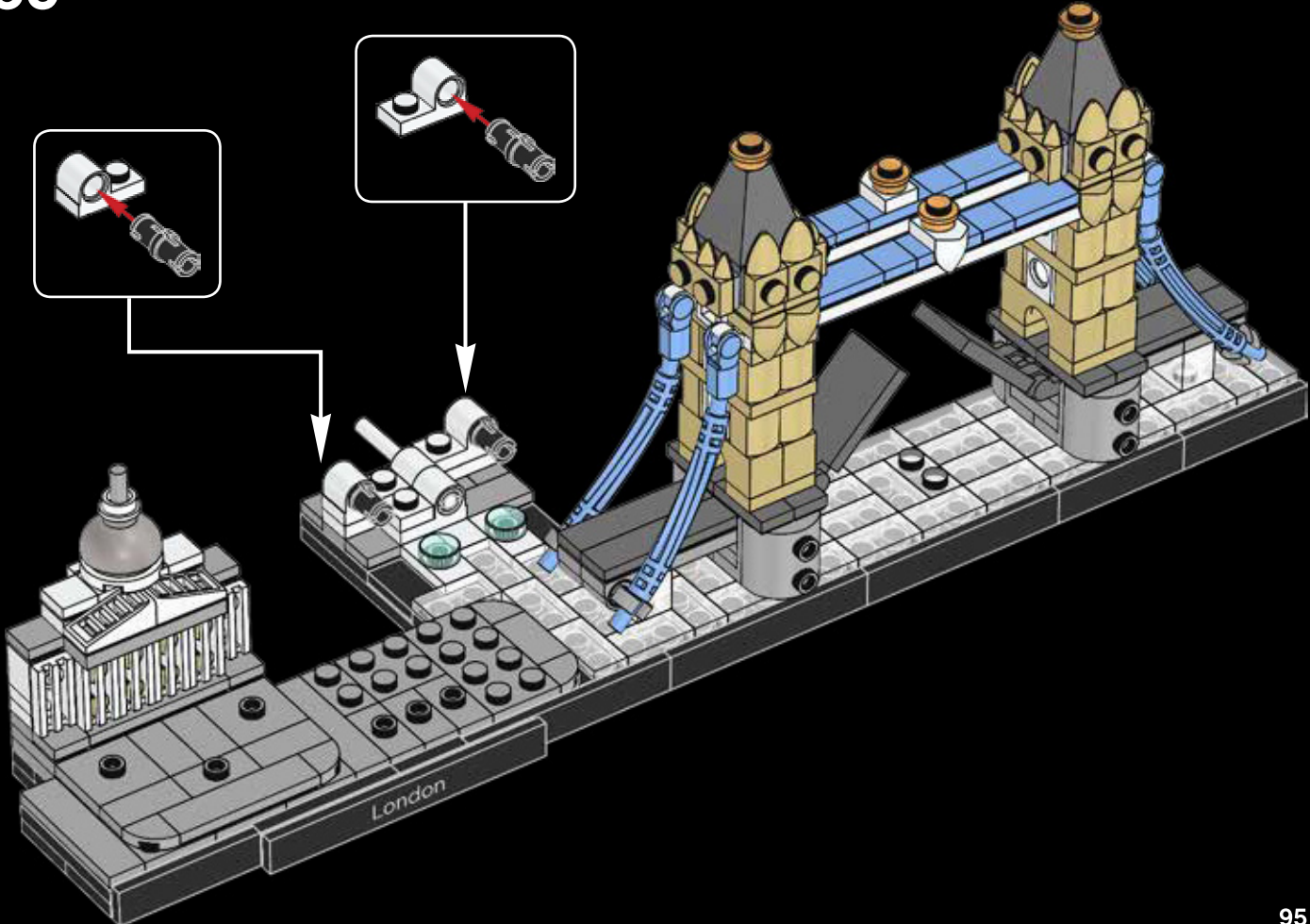

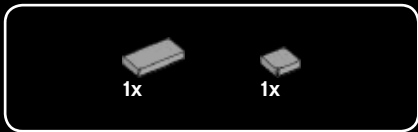

70

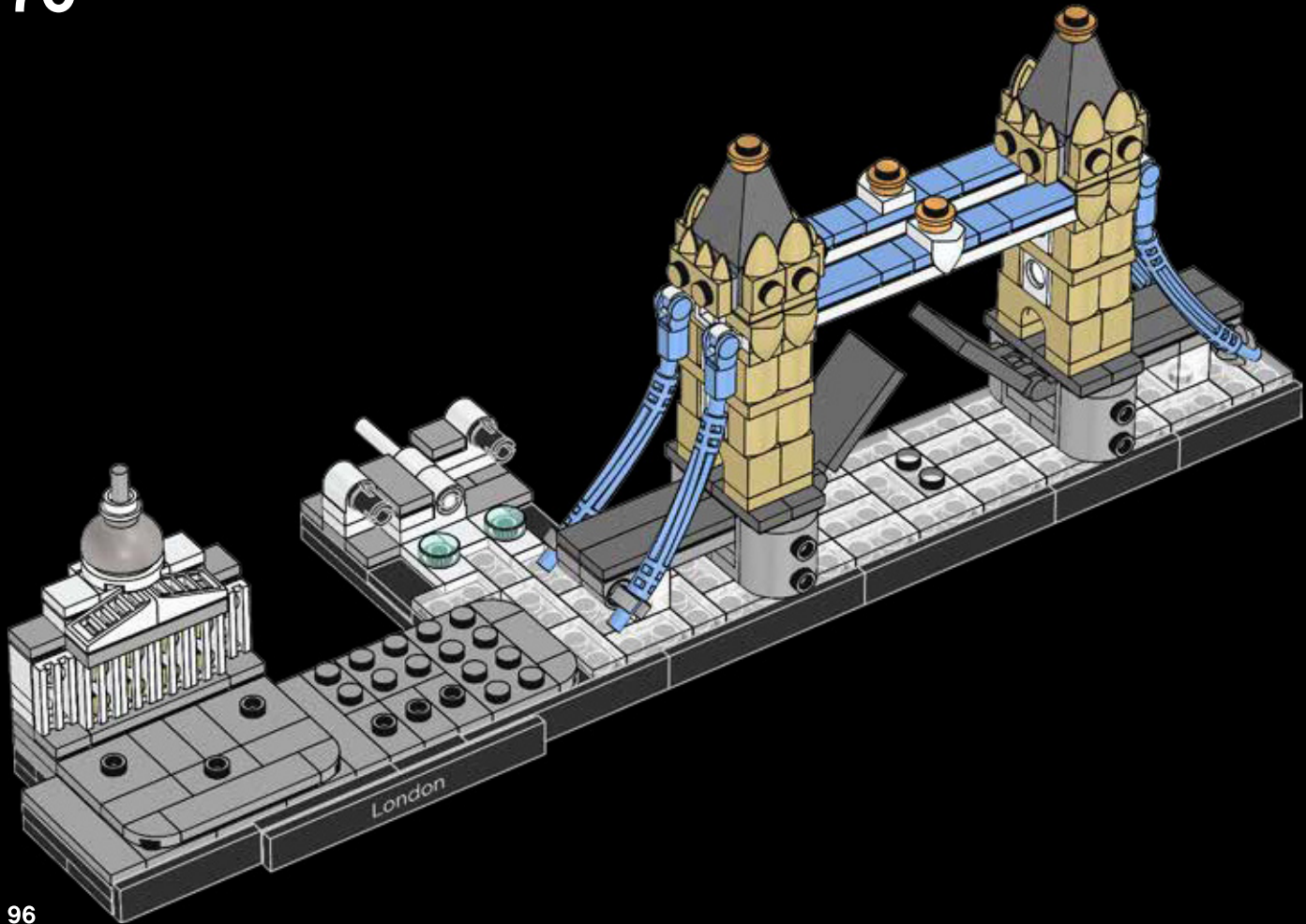





71

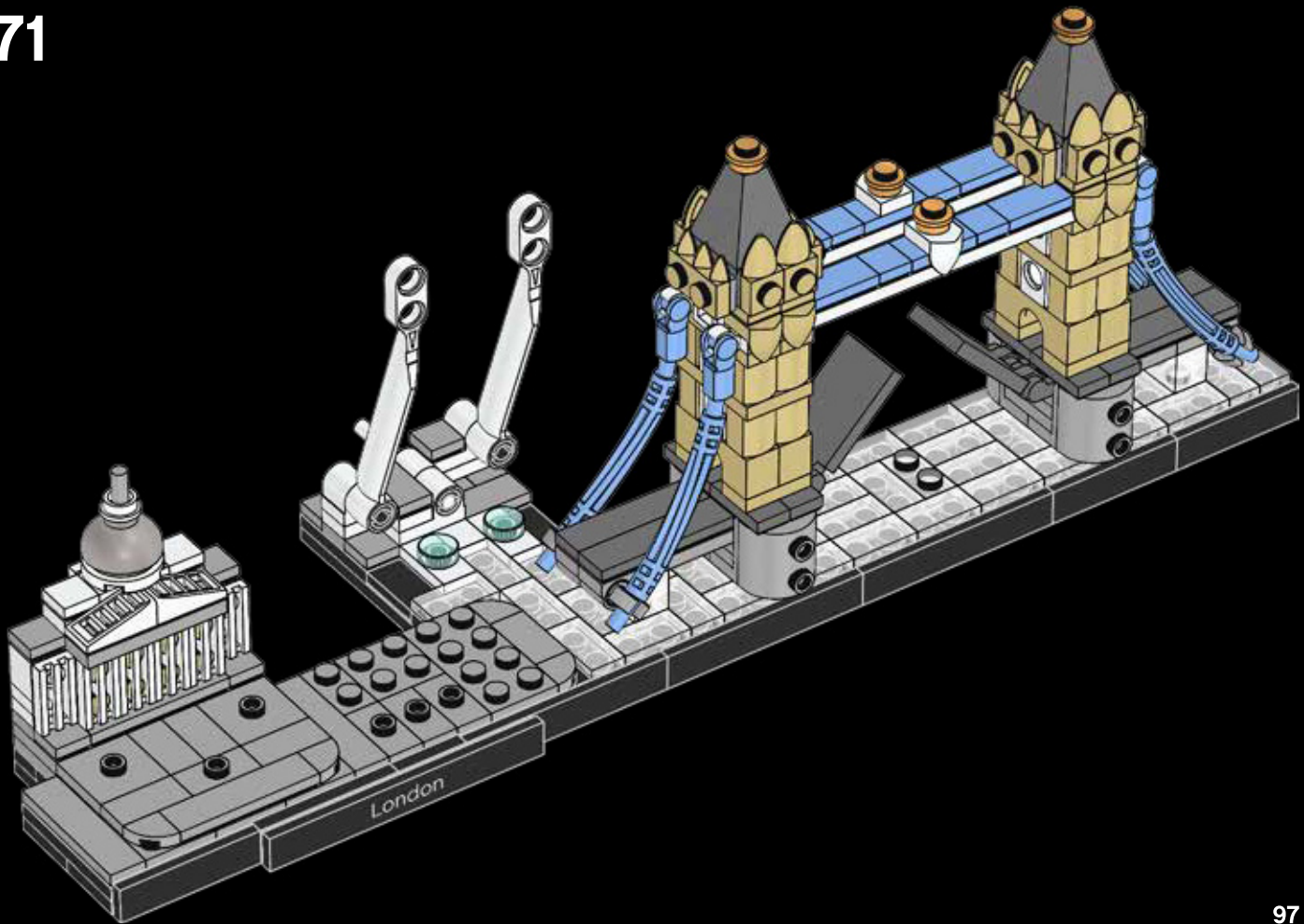

1x

72

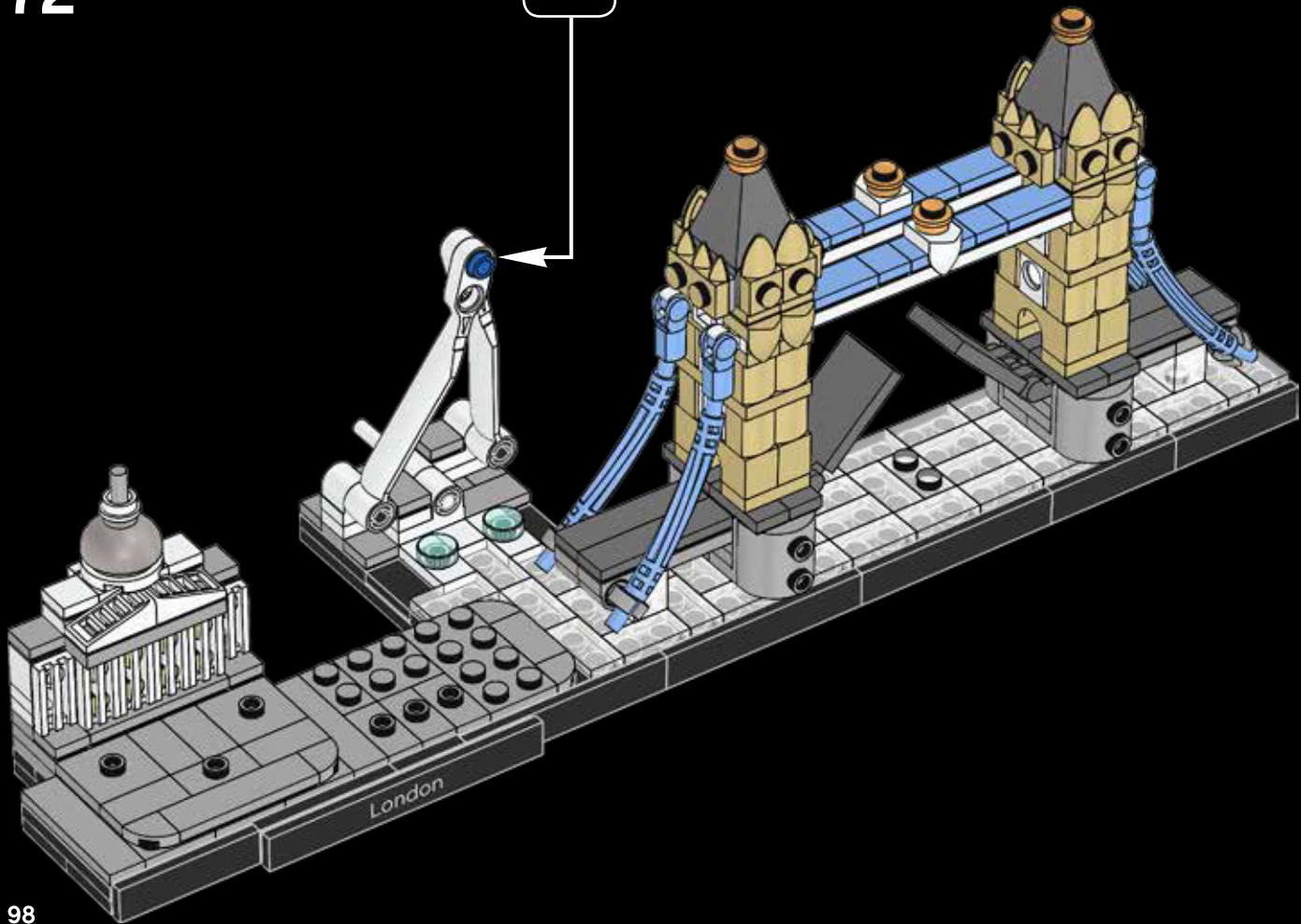

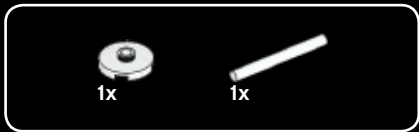

73

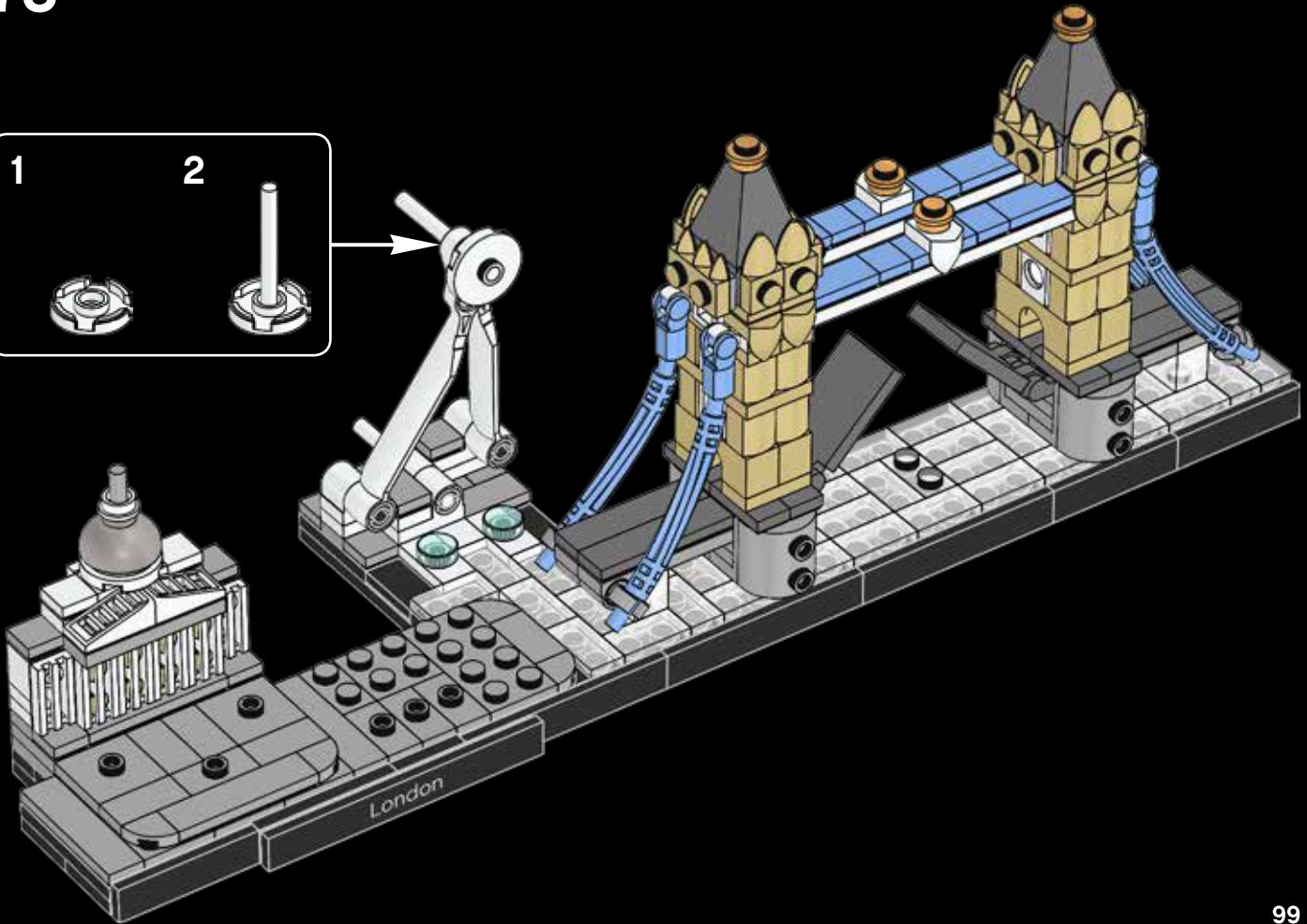
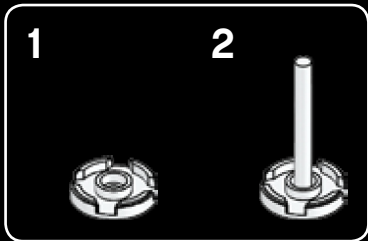



1x

74

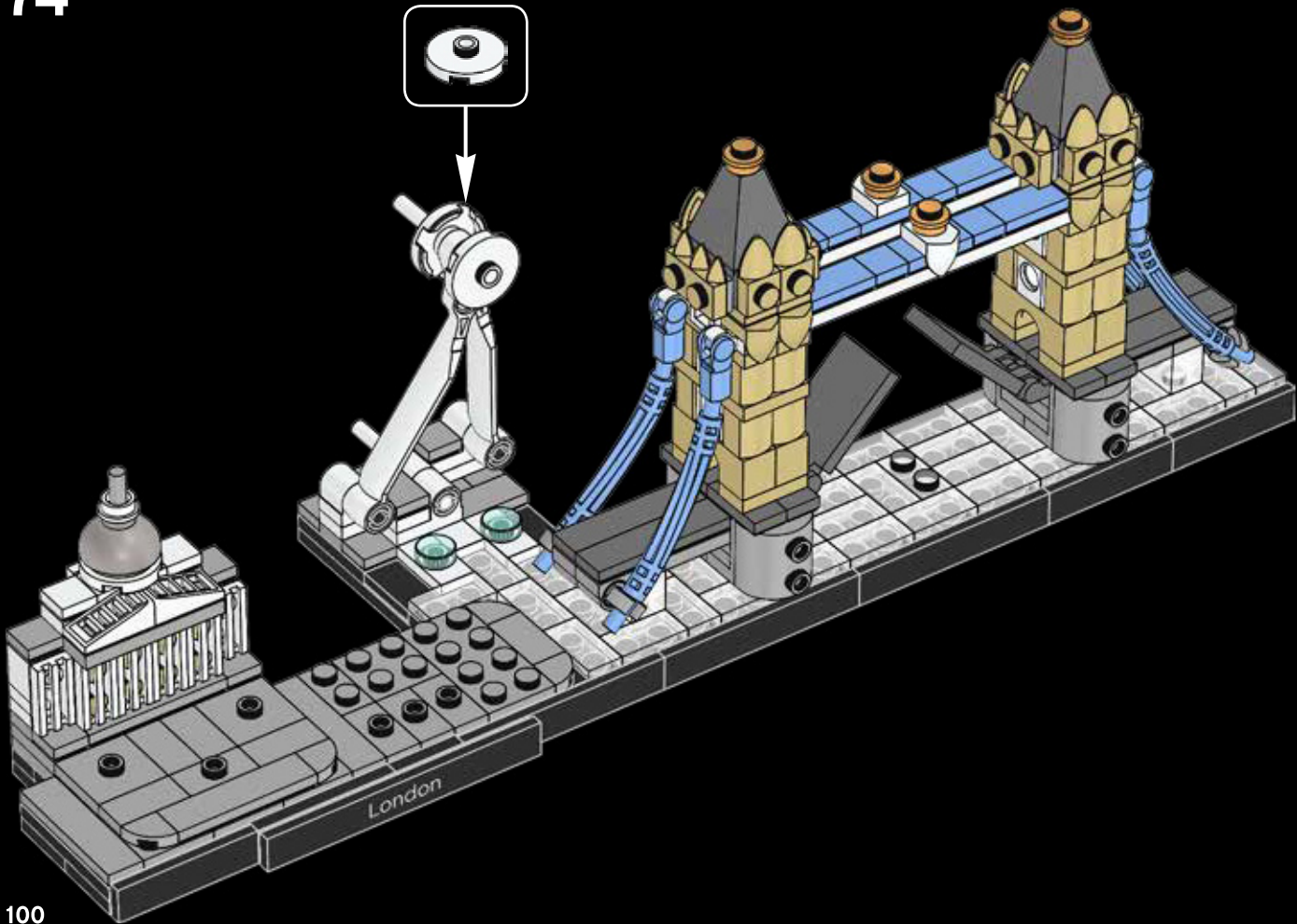



1x

75



1x

76



1x

77



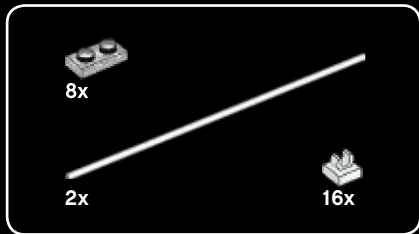
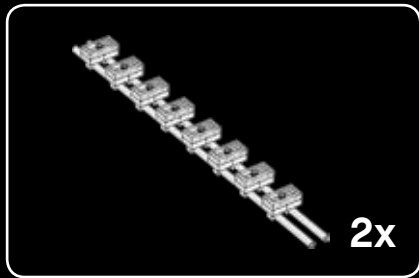

78

1



2



3



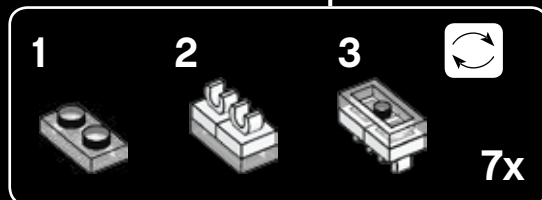
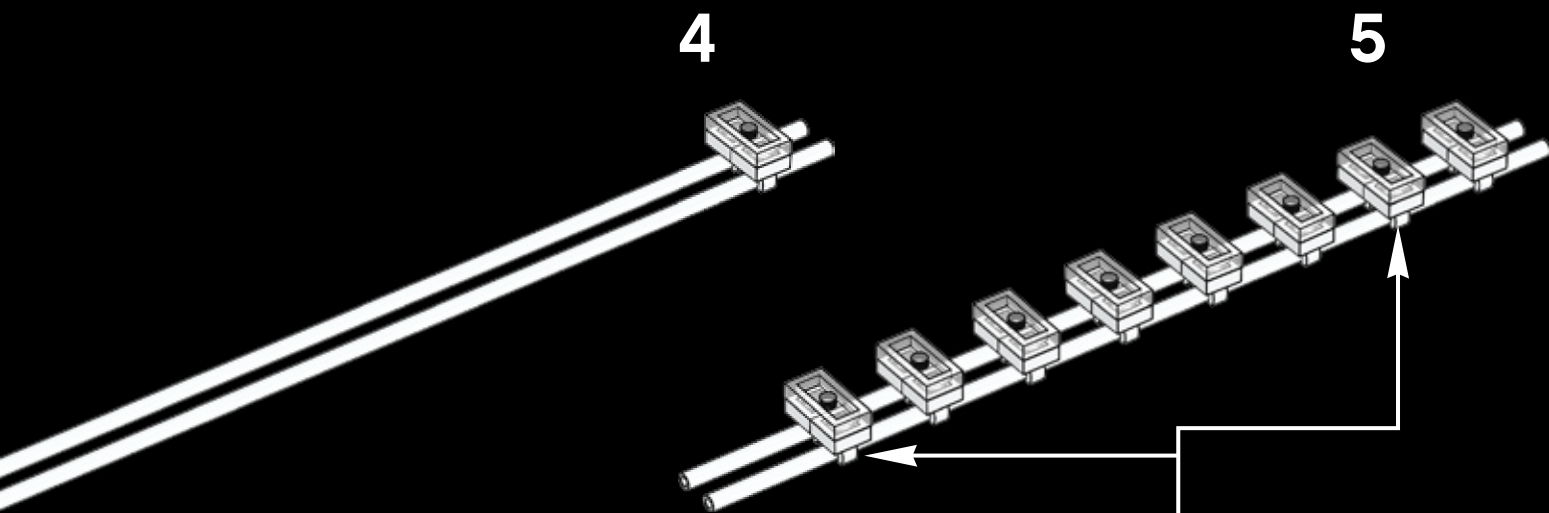
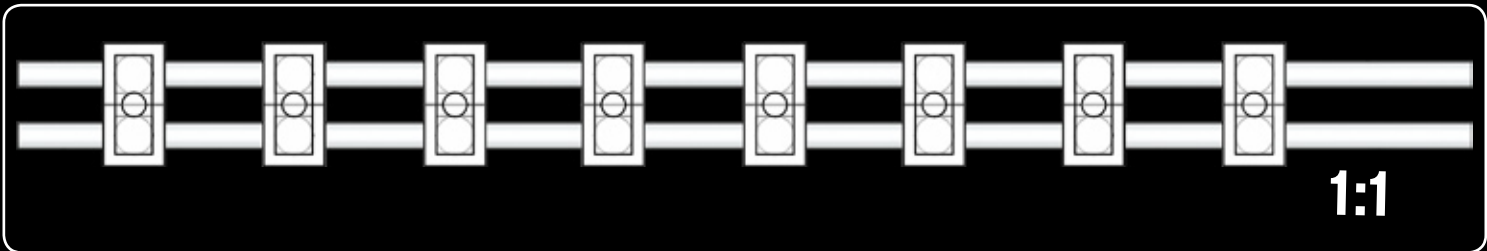

2x  
103

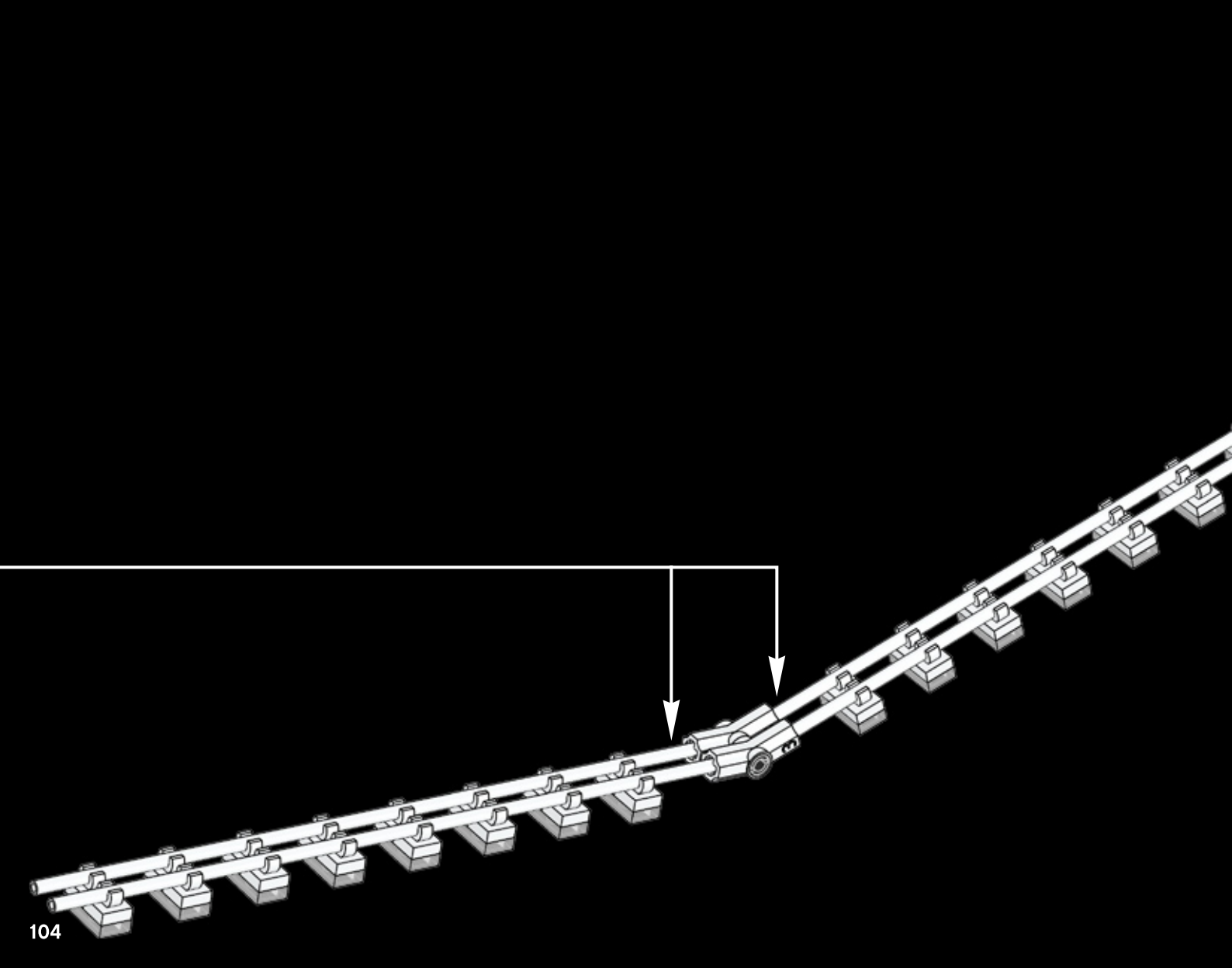





79

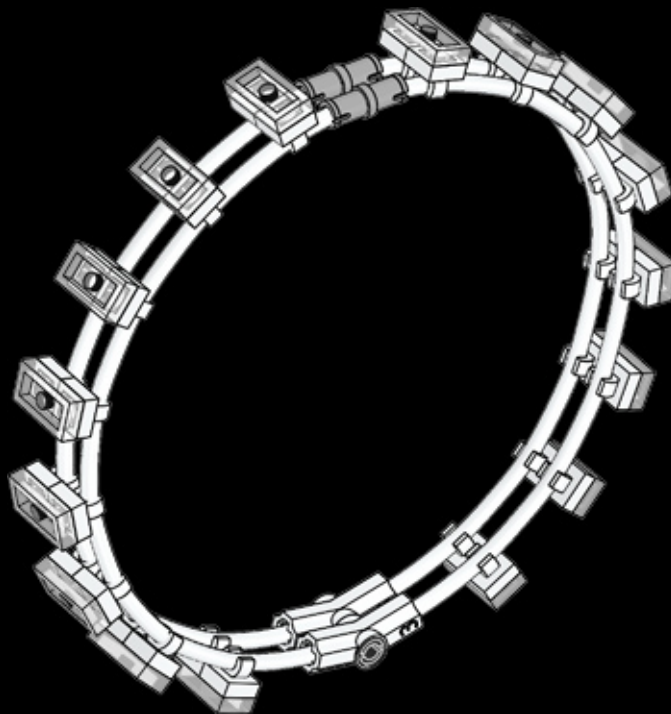

The London Eye has 32 capsules, one for each of the 32 London boroughs.

Le London Eye a 32 capsules, une pour chacun des 32 arrondissements de Londres.

El London Eye posee 32 cápsulas, una por cada uno de los 32 distritos de Londres.



80

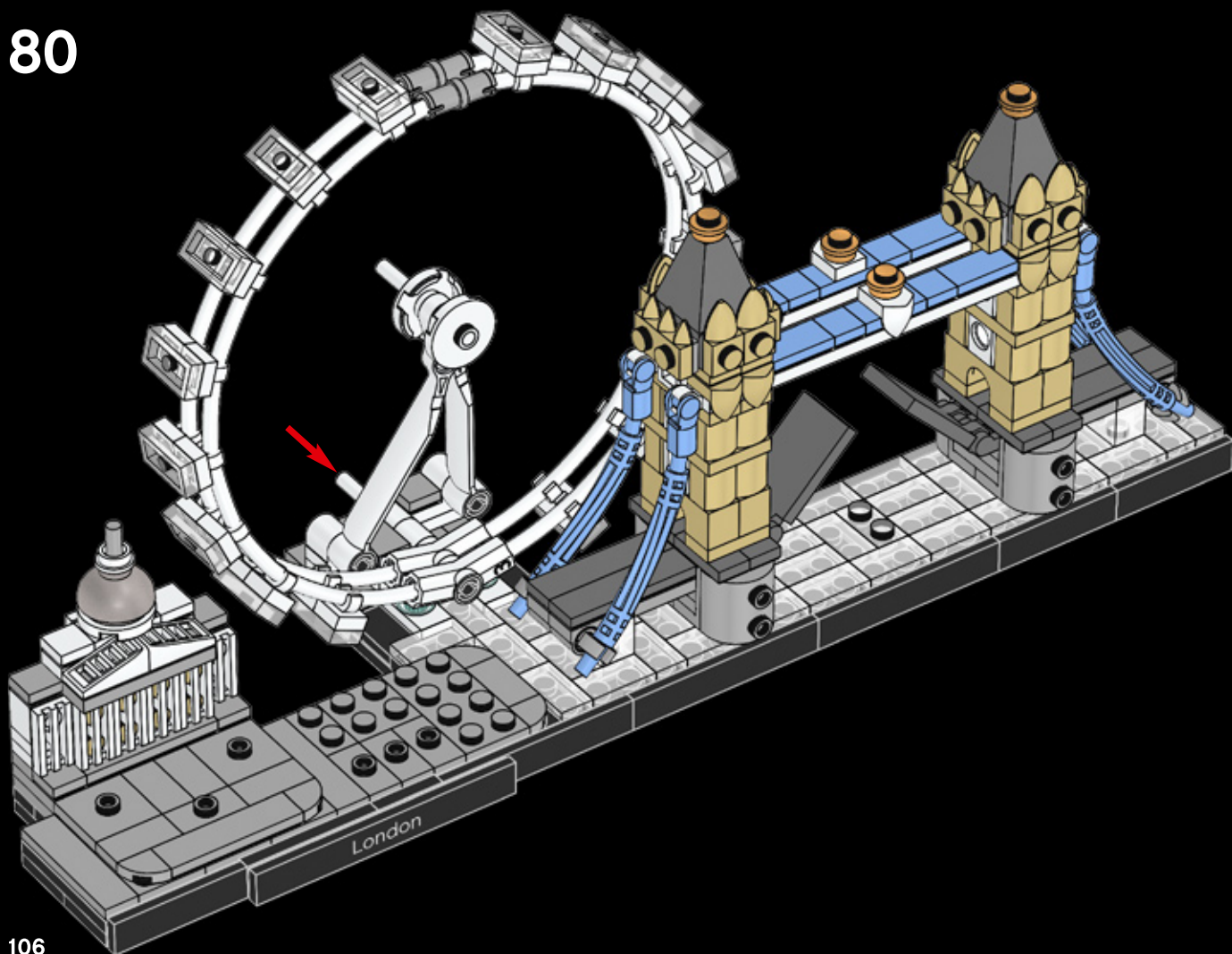

106

81

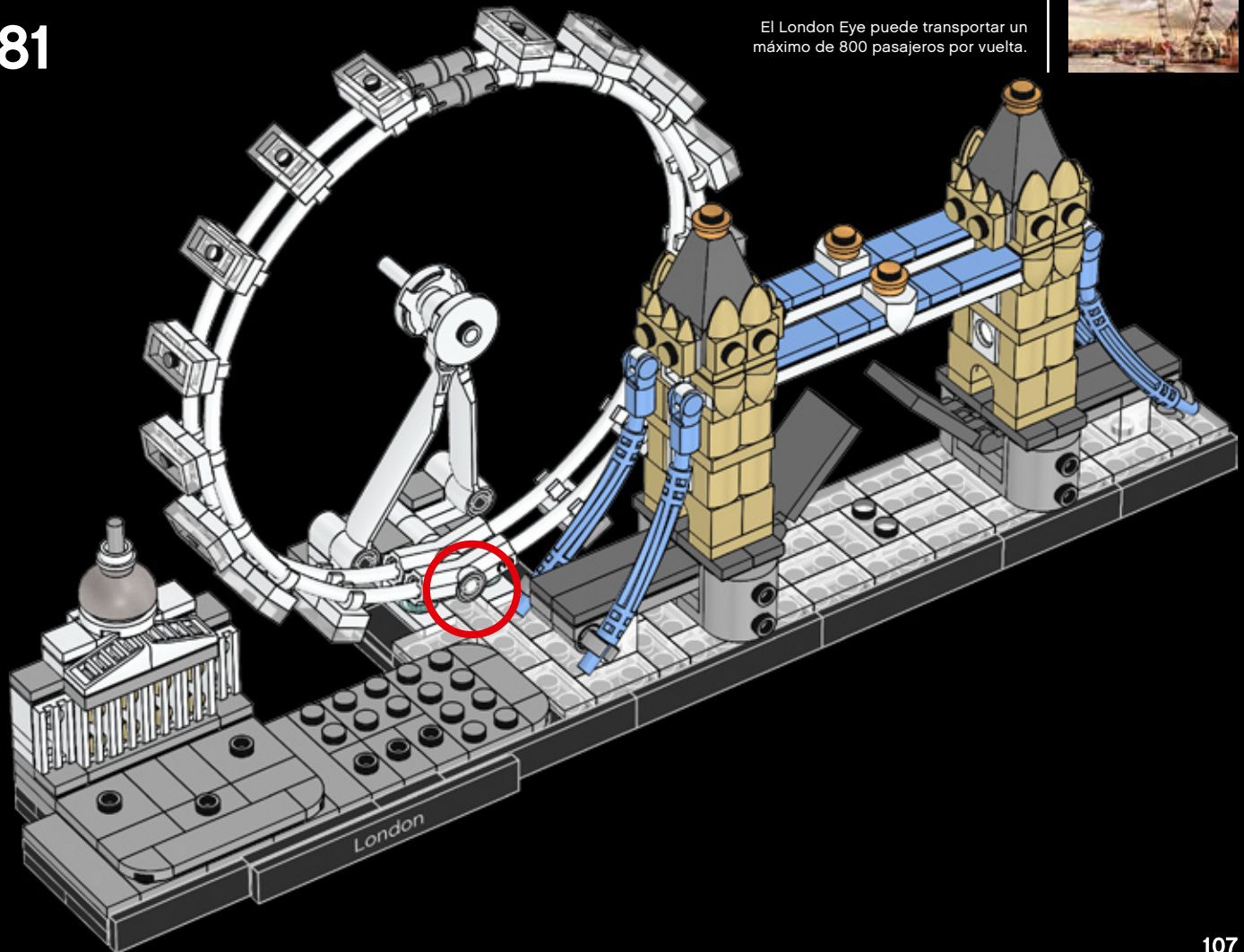

The London Eye can carry up to 800 people on each rotation.

Le London Eye peut transporter jusqu'à 800 personnes lors de chaque rotation.

El London Eye puede transportar un máximo de 800 pasajeros por vuelta.





82

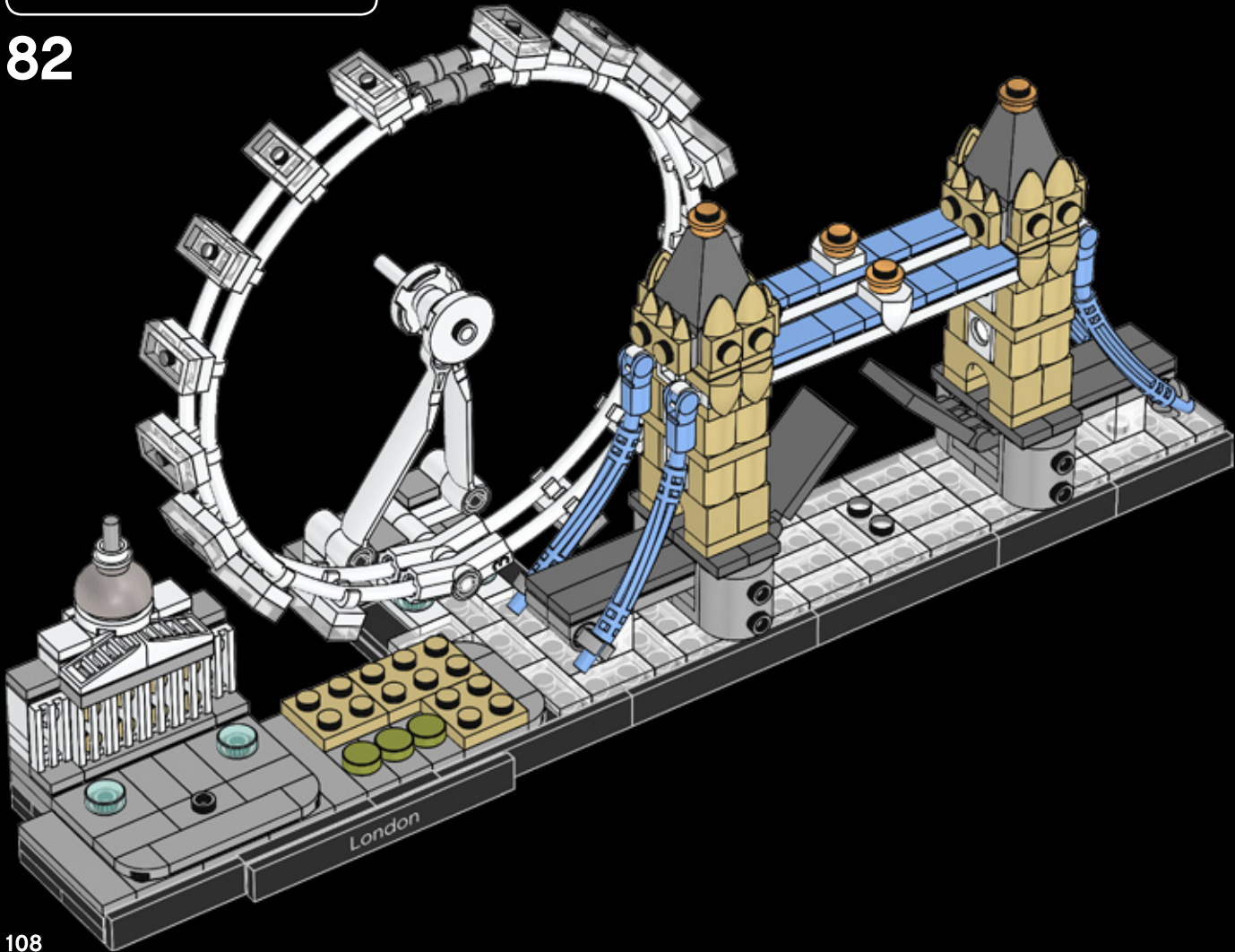



5x

83

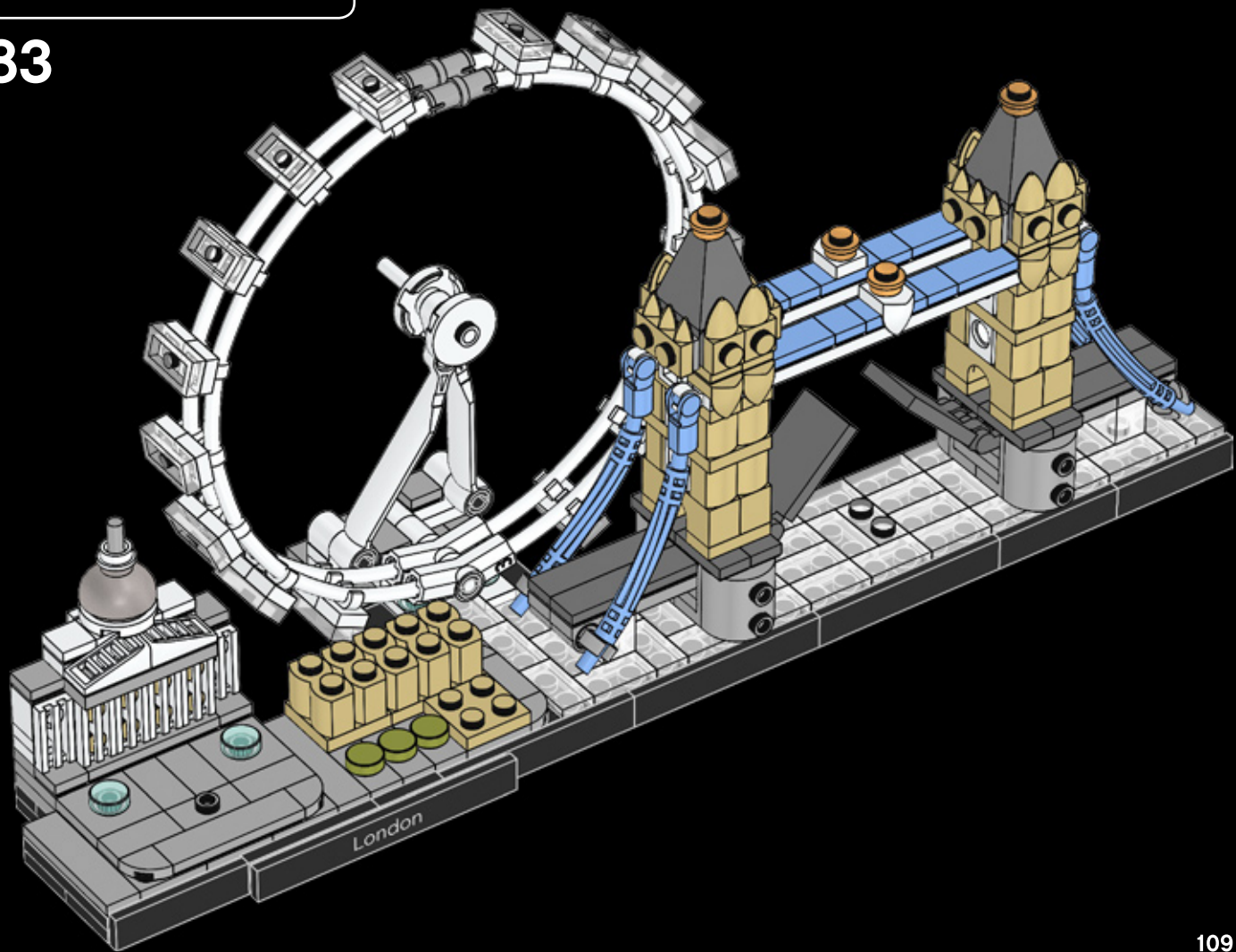



2x

84

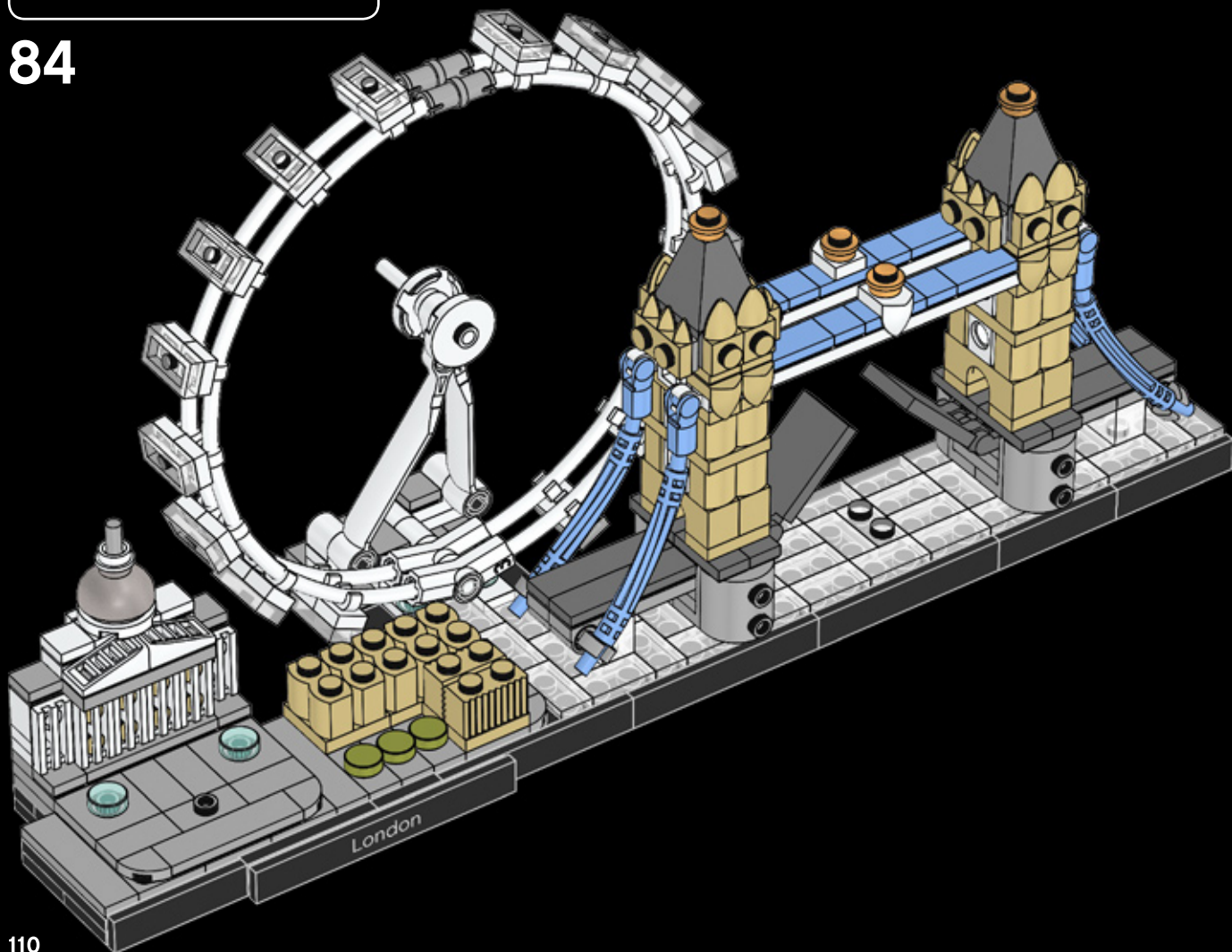



85

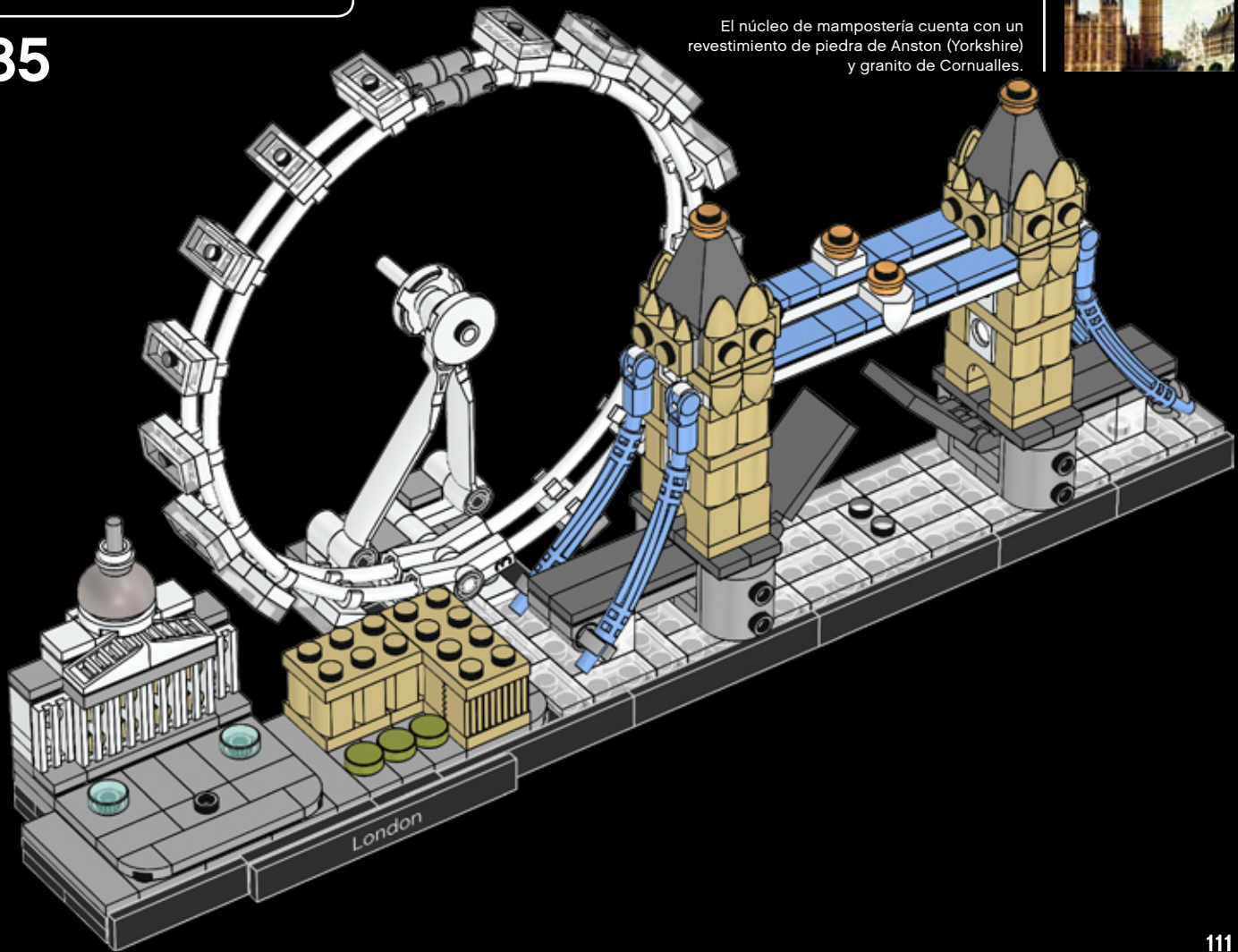

Anston stone from Yorkshire and granite from Cornwall were used on the exterior of the tower to clad the brickwork core.

De la pierre d'Anston du Yorkshire et du granit de Cornouailles ont été utilisés à l'extérieur de la tour pour couvrir le centre en briques.

El núcleo de mampostería cuenta con un revestimiento de piedra de Anston (Yorkshire) y granito de Cornualles.





5x

86

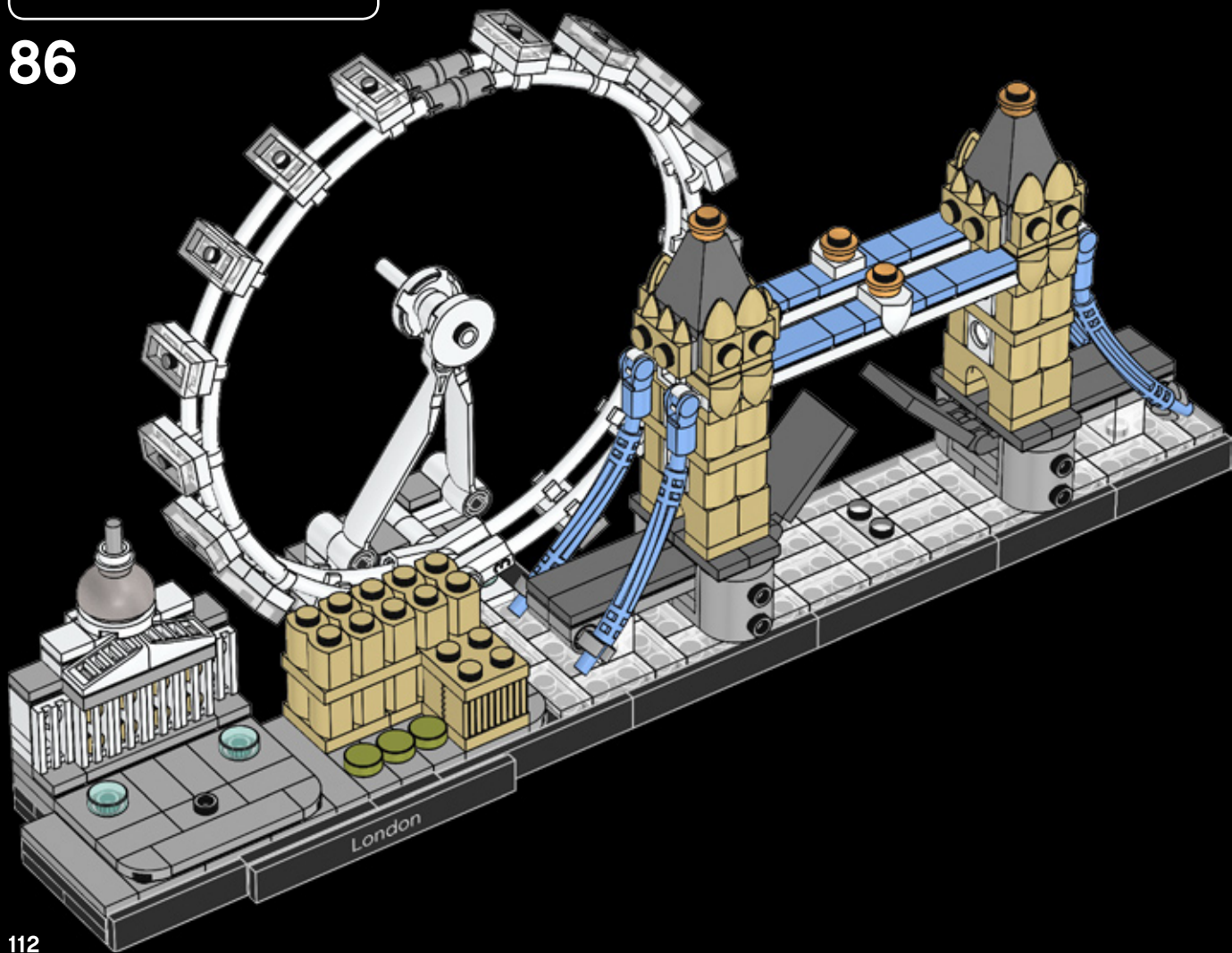





2x

87

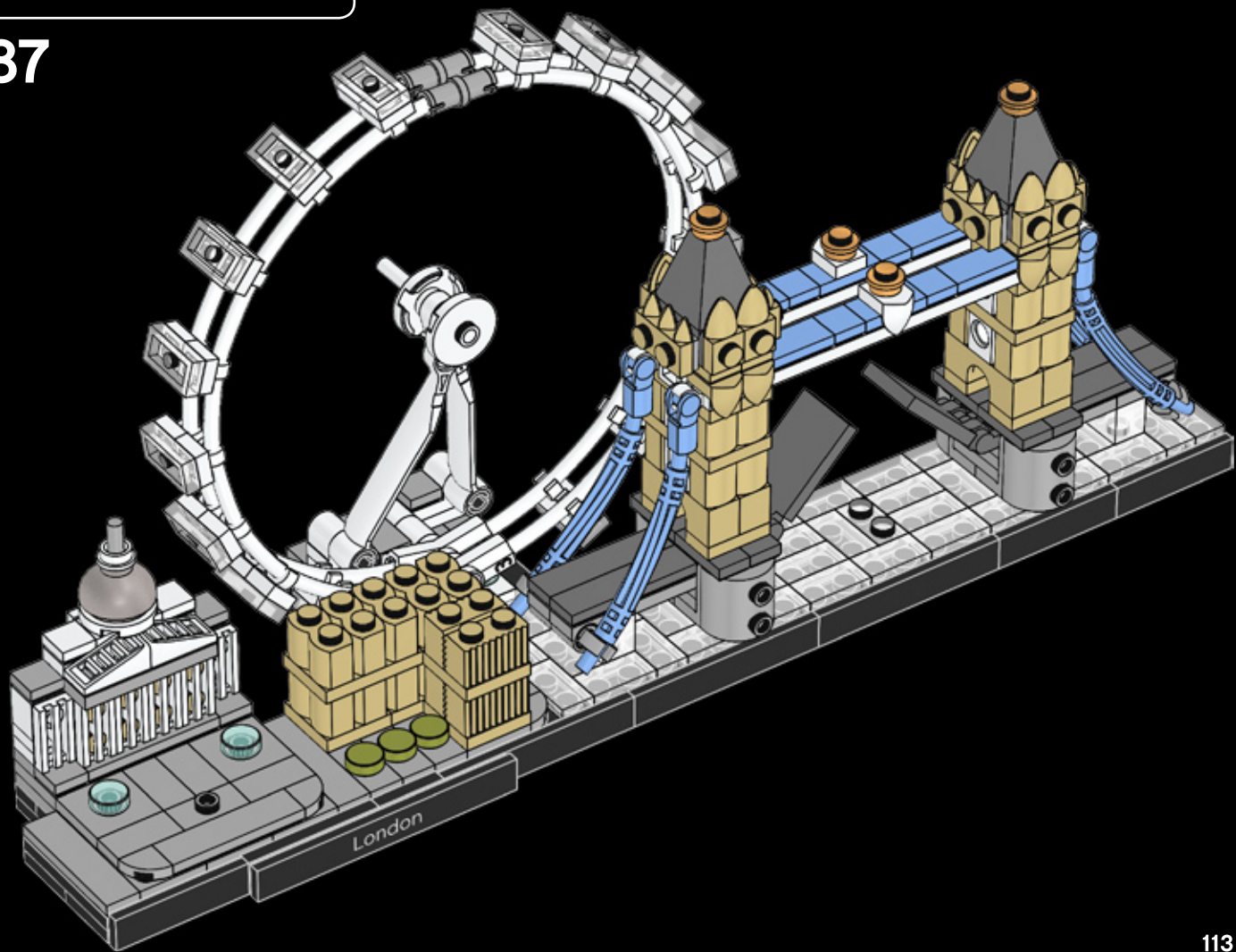



1x

88

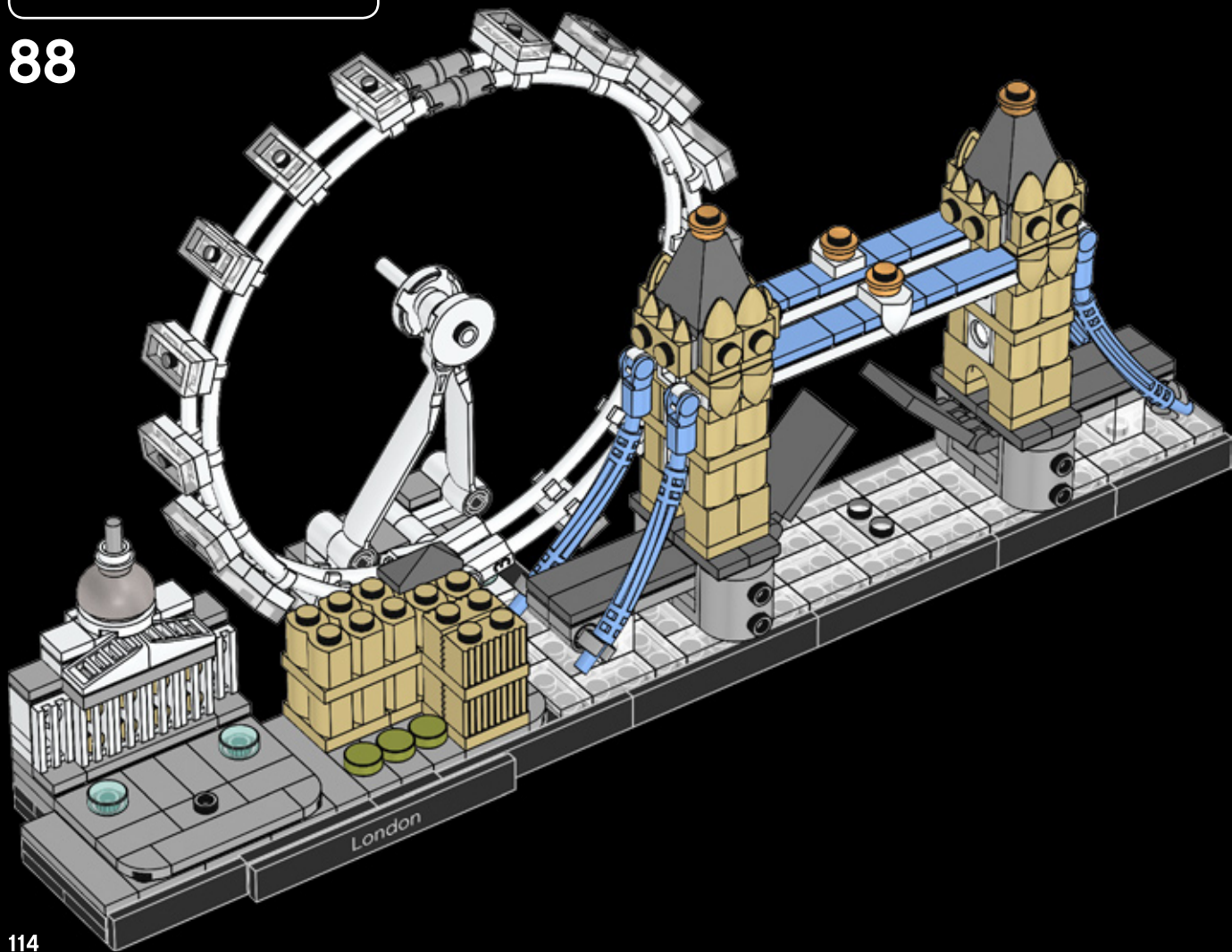

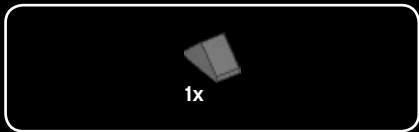

89

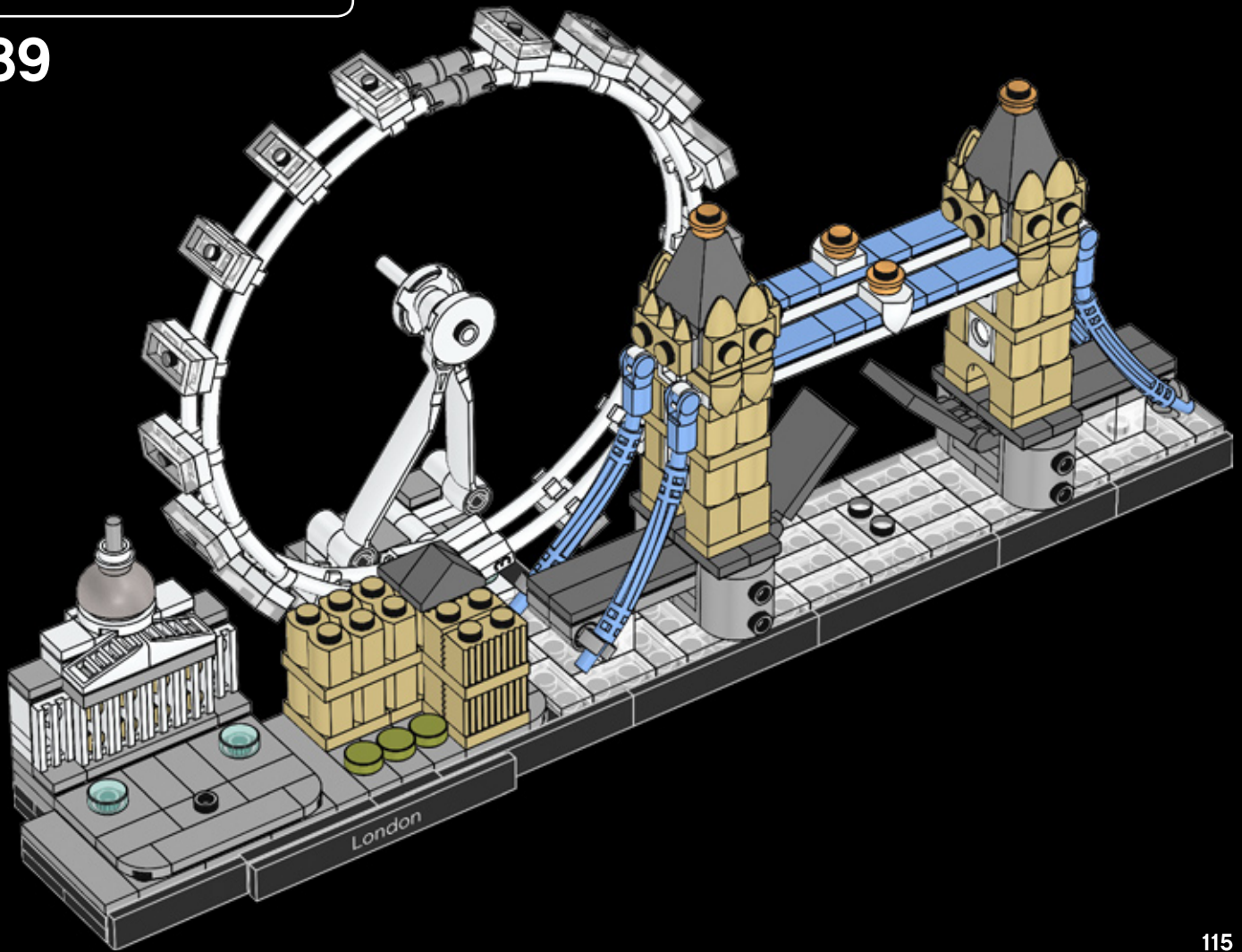



90

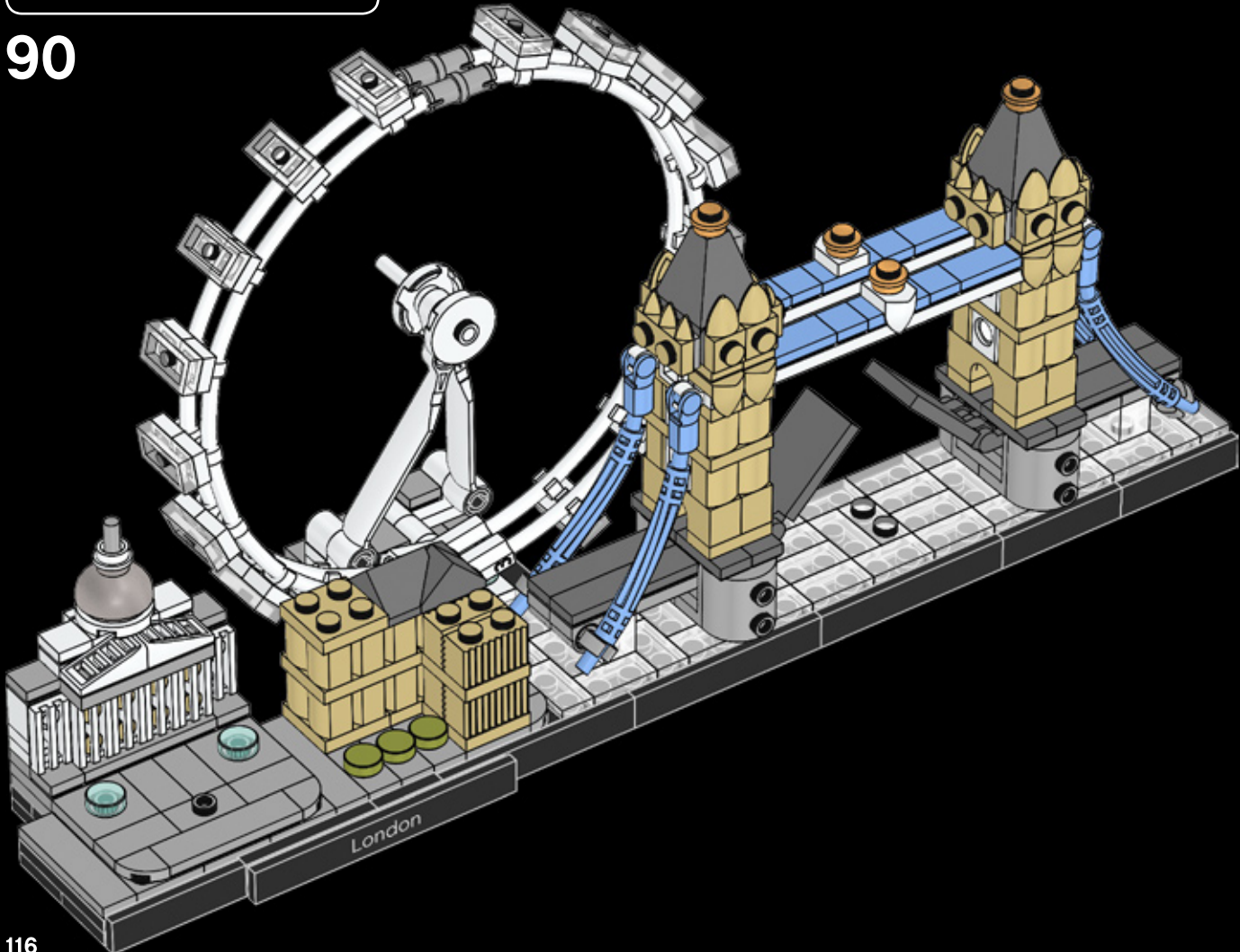



2x

91

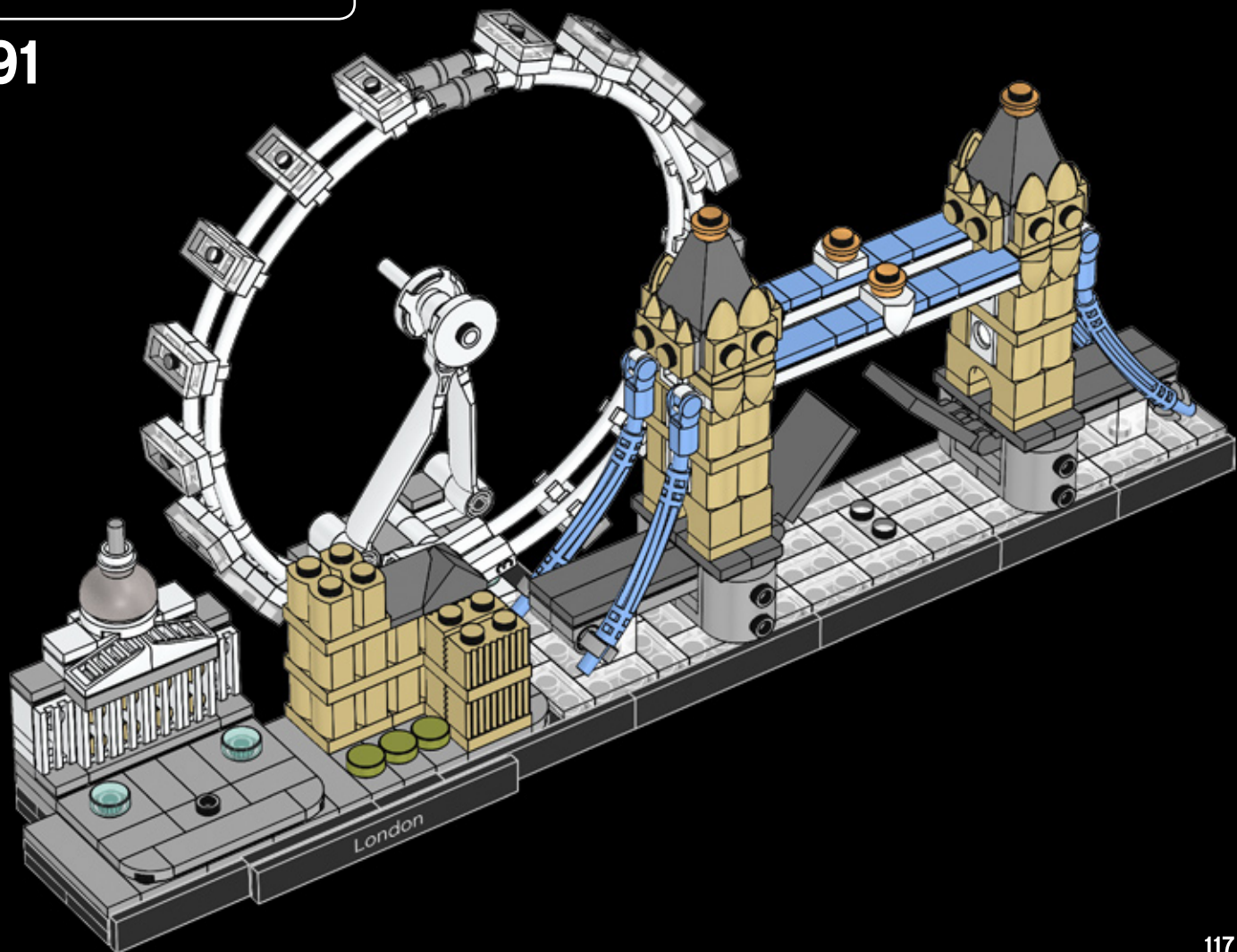



4x

92

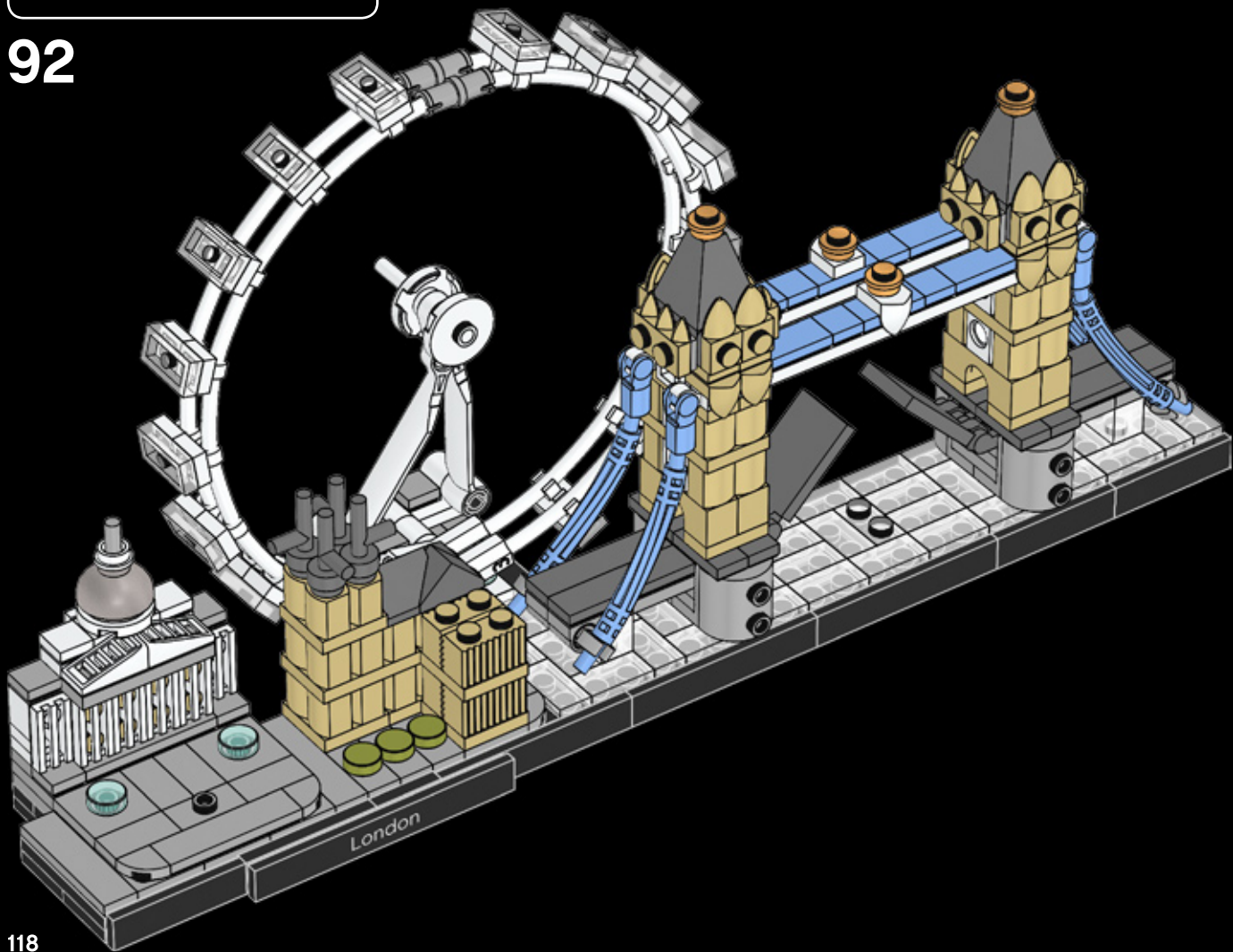



93

1



2



3



4



5



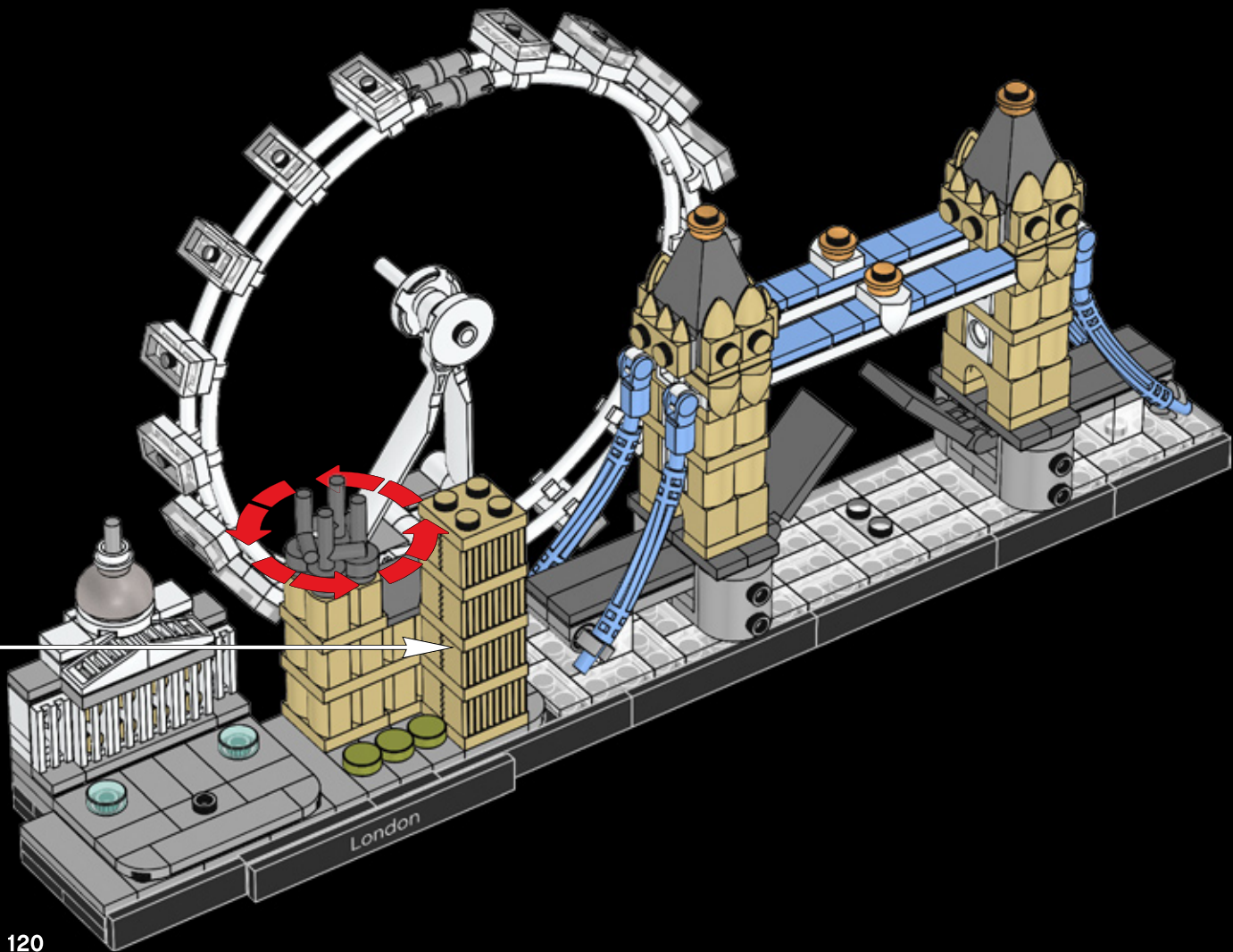





94

Under each clock dial there is a Latin inscription carved in stone that means "O Lord, keep safe our Queen Victoria the First."

Sous chaque cadran de l'horloge est gravée dans la pierre une inscription en latin qui signifie « Ô Seigneur, protège notre Reine Victoria Première ».

Bajo la esfera del reloj puede verse una inscripción en latín labrada en la piedra que significa: «Oh señor, mantén a salvo a nuestra reina, Victoria I».



1



2



3



4



5



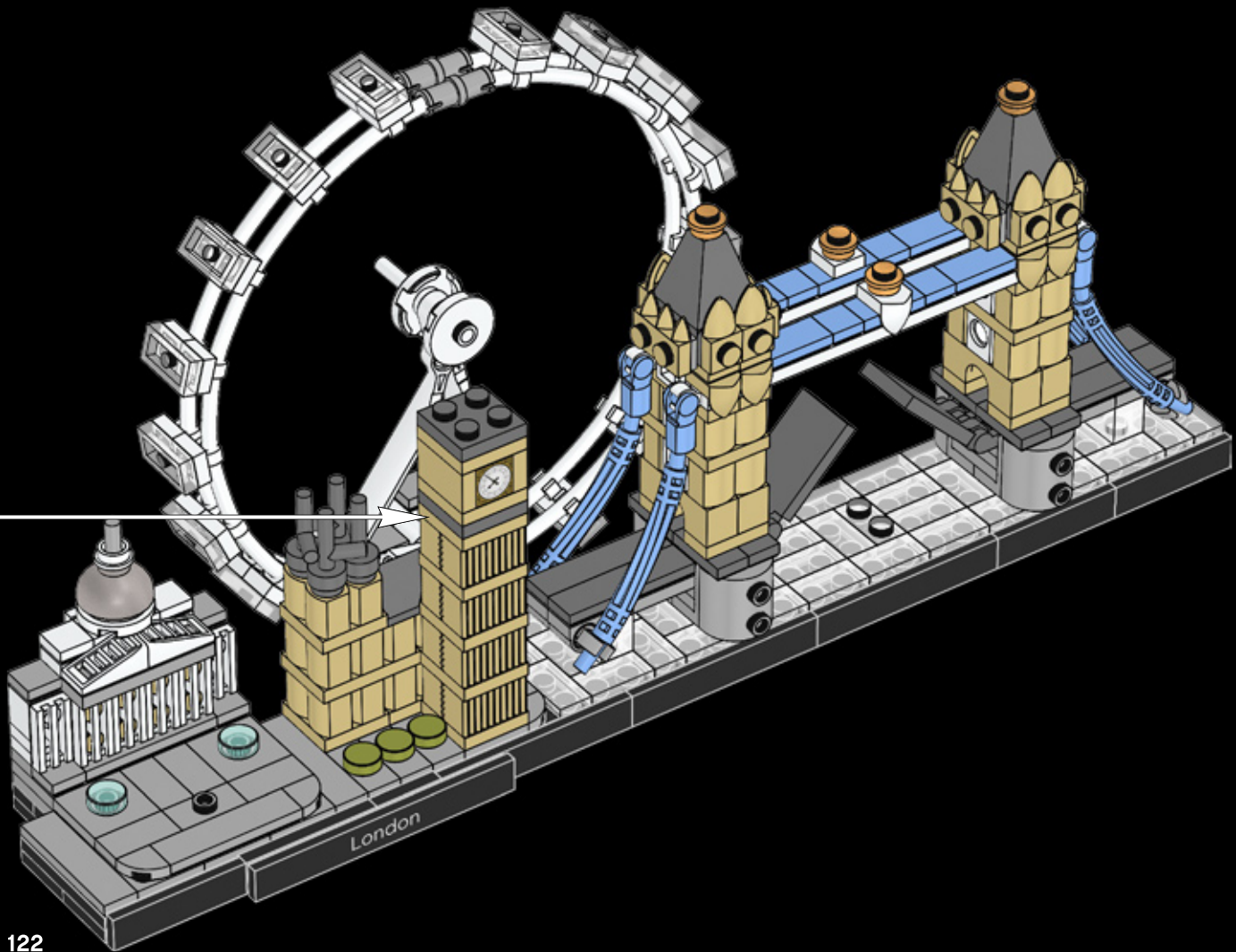



95

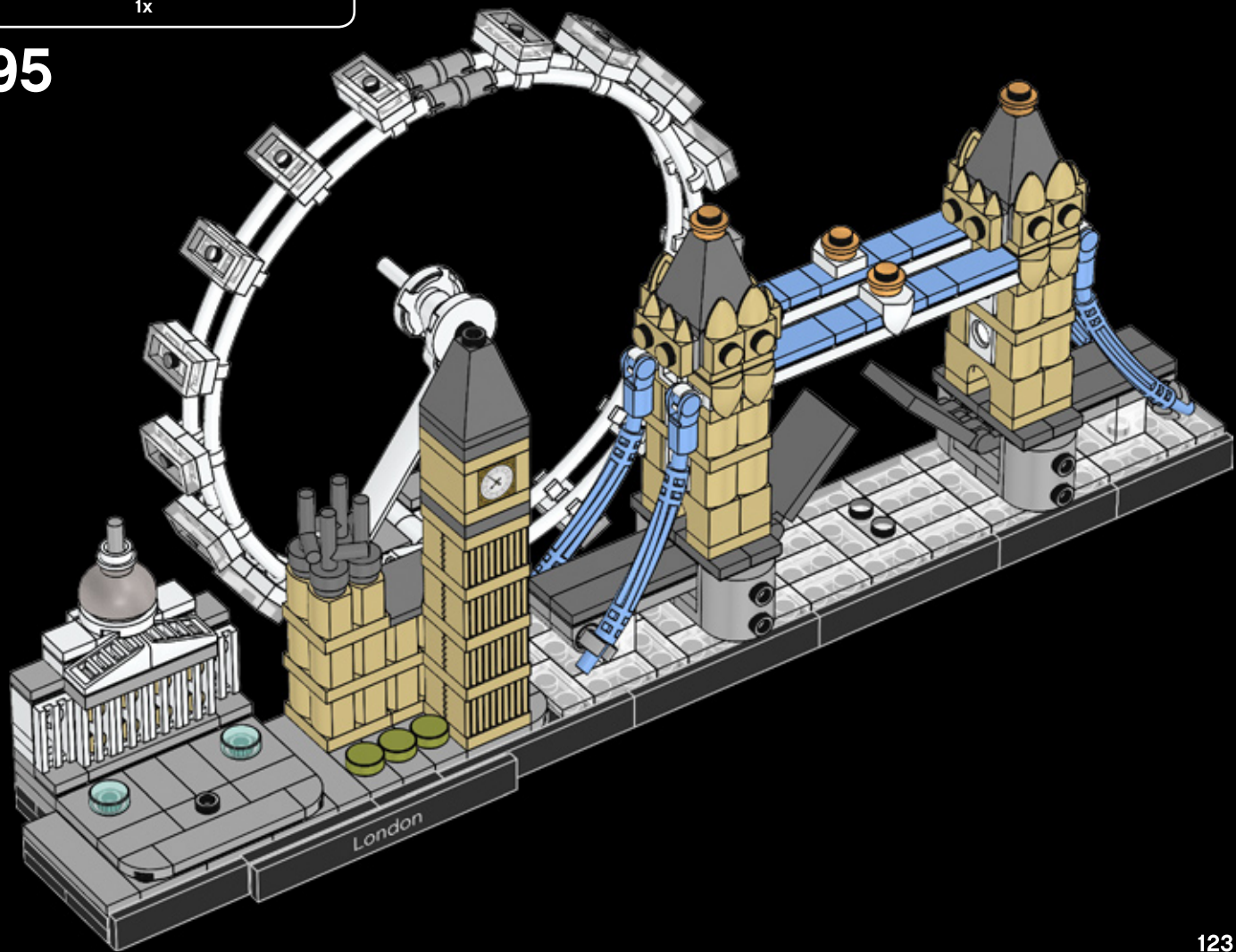



1x



1x

96

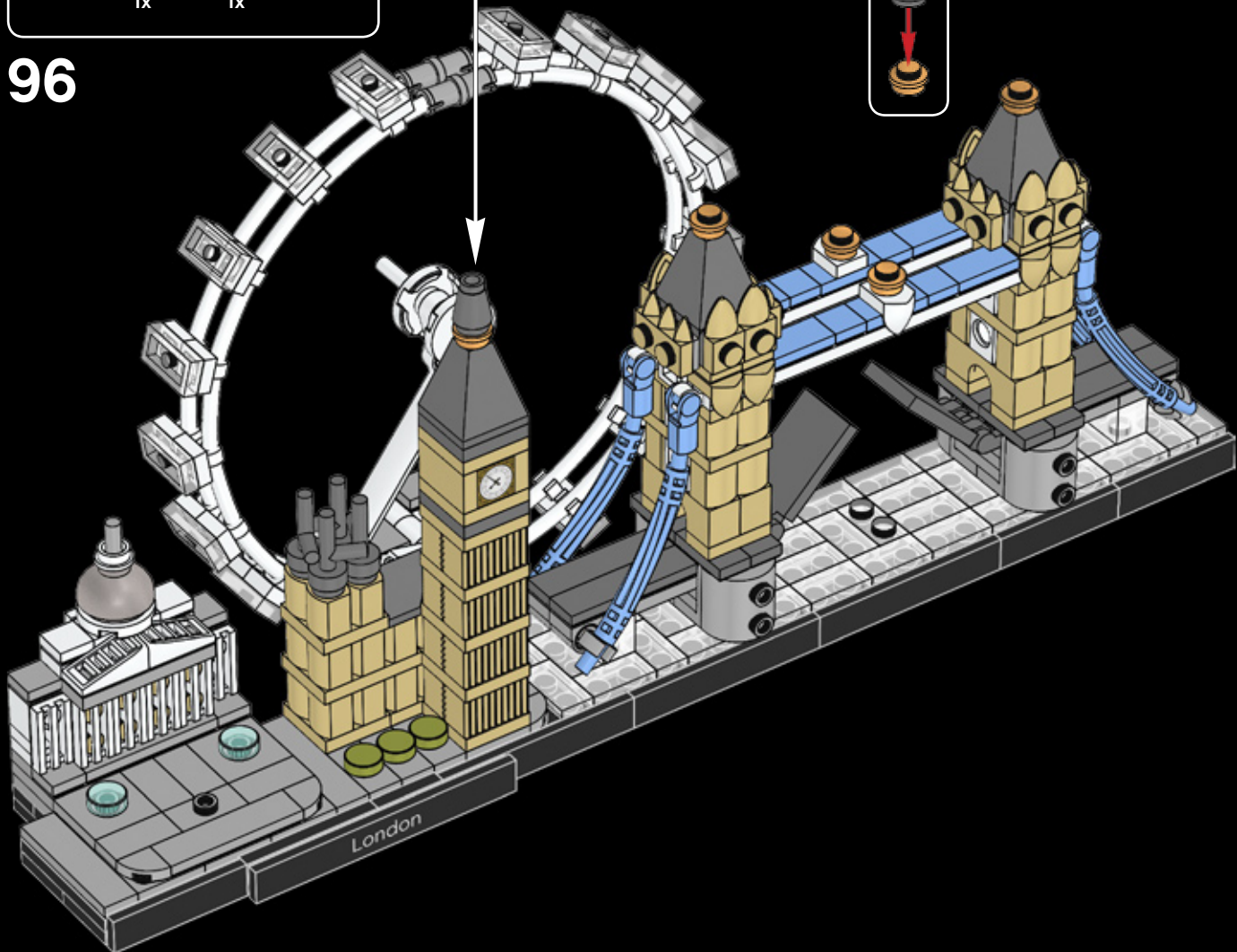
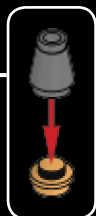

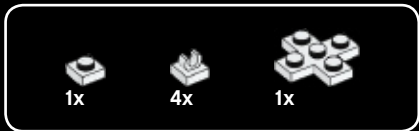

97

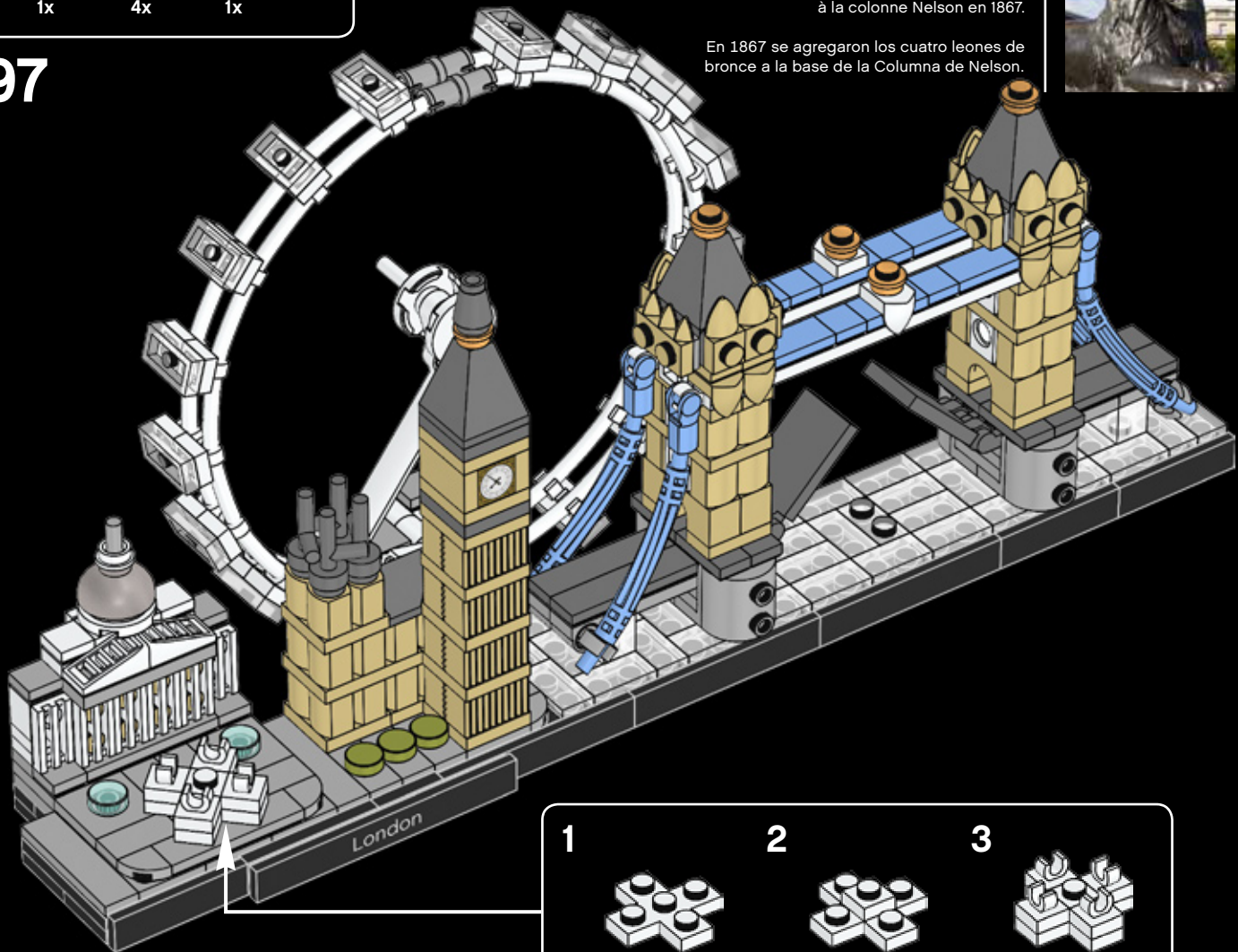

The four bronze lions at the base were added to Nelson's Column in 1867.

Les quatre lions de bronze à la base furent ajoutés à la colonne Nelson en 1867.

En 1867 se agregaron los cuatro leones de bronce a la base de la Columna de Nelson.

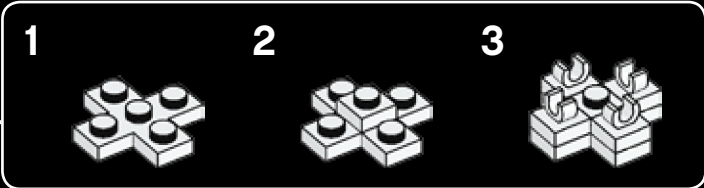



# 98

1



2



3



4



5



6



While the column is built in granite, the statue of Nelson is made from sandstone.

La colonne est construite en granit, mais la statue de Nelson est faite de grès.

Aunque la columna es de granito, la estatua de Nelson está esculpida en piedra caliza.

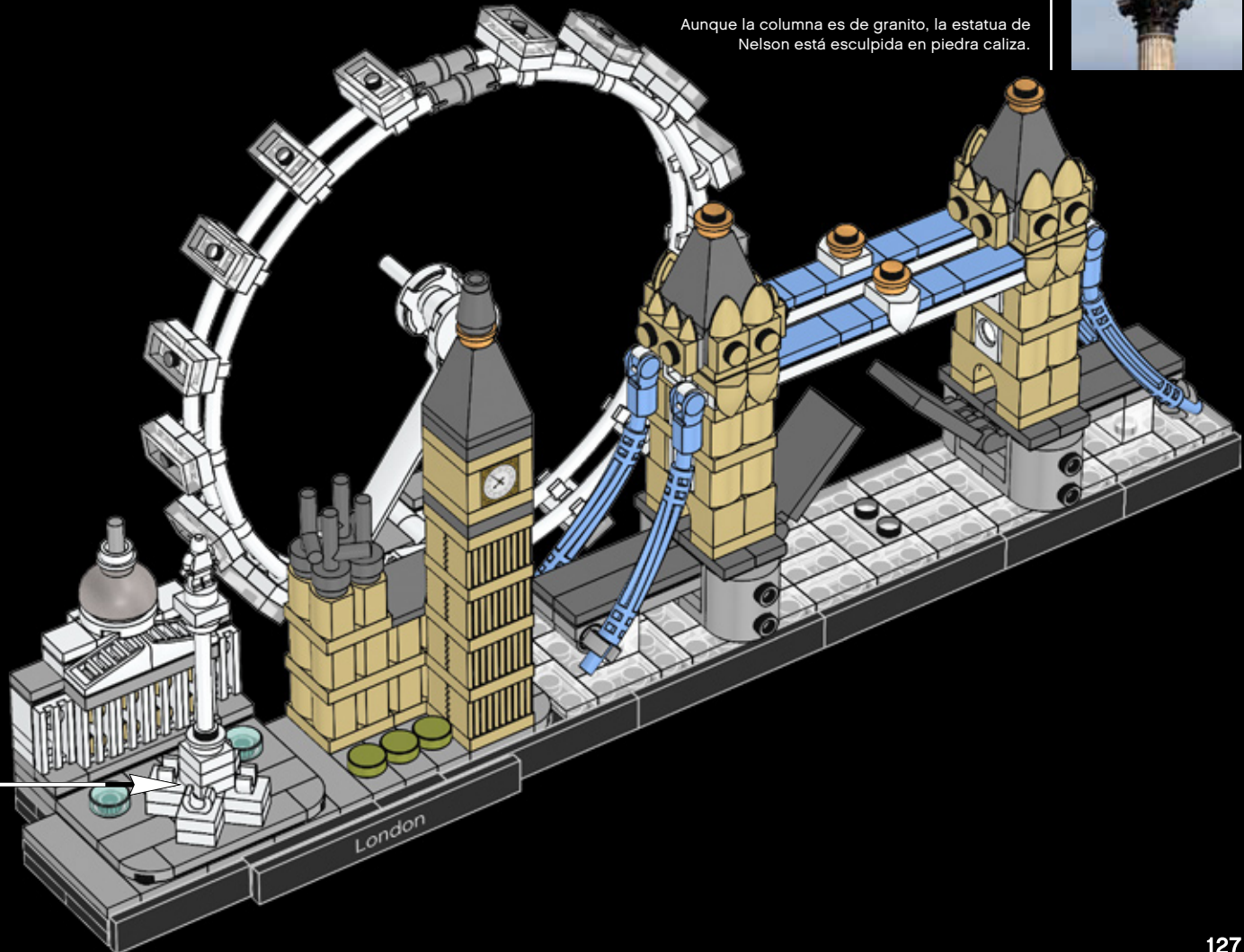

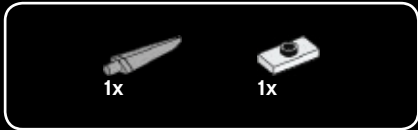

99

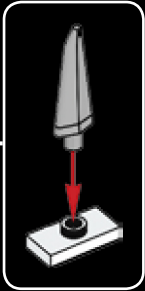
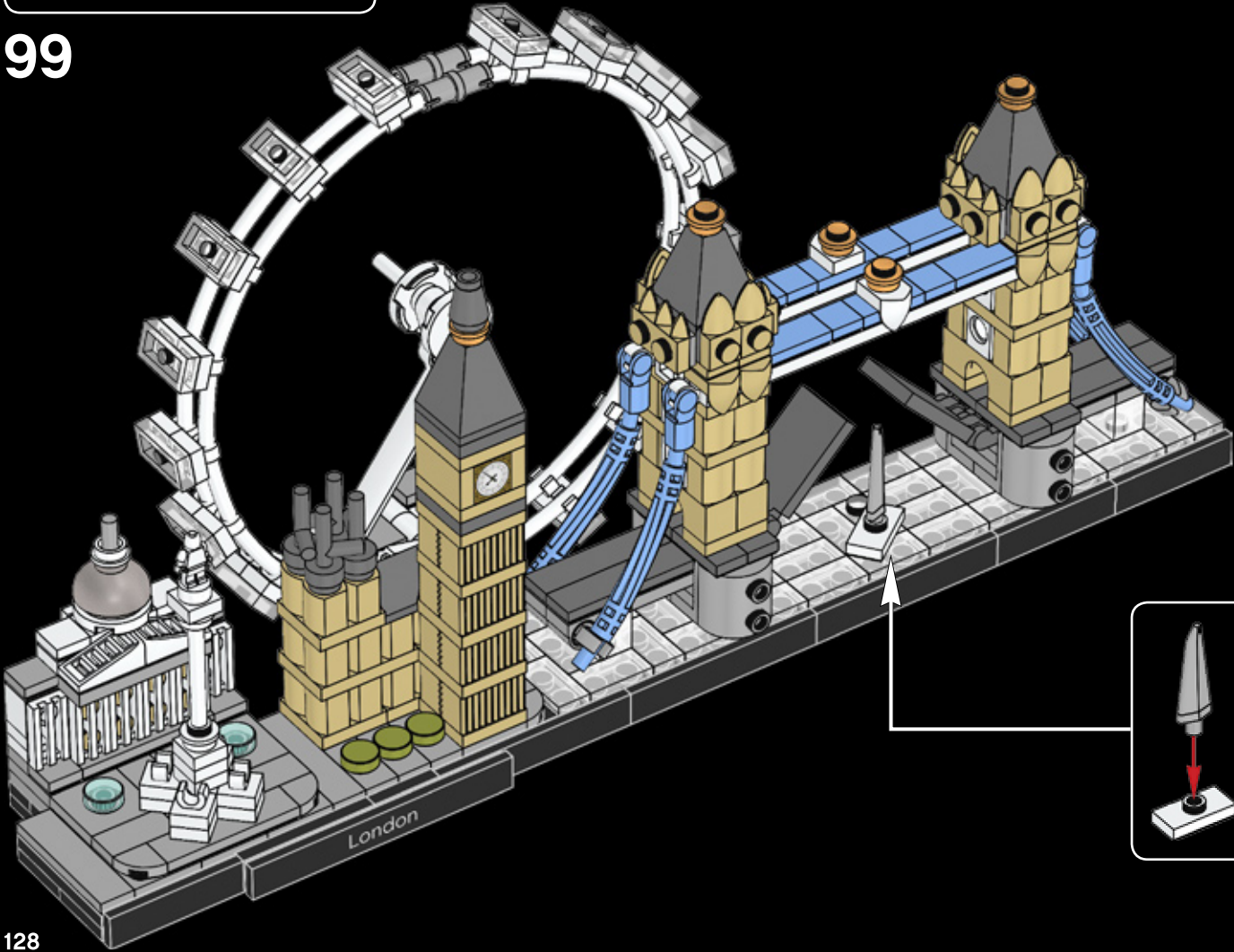



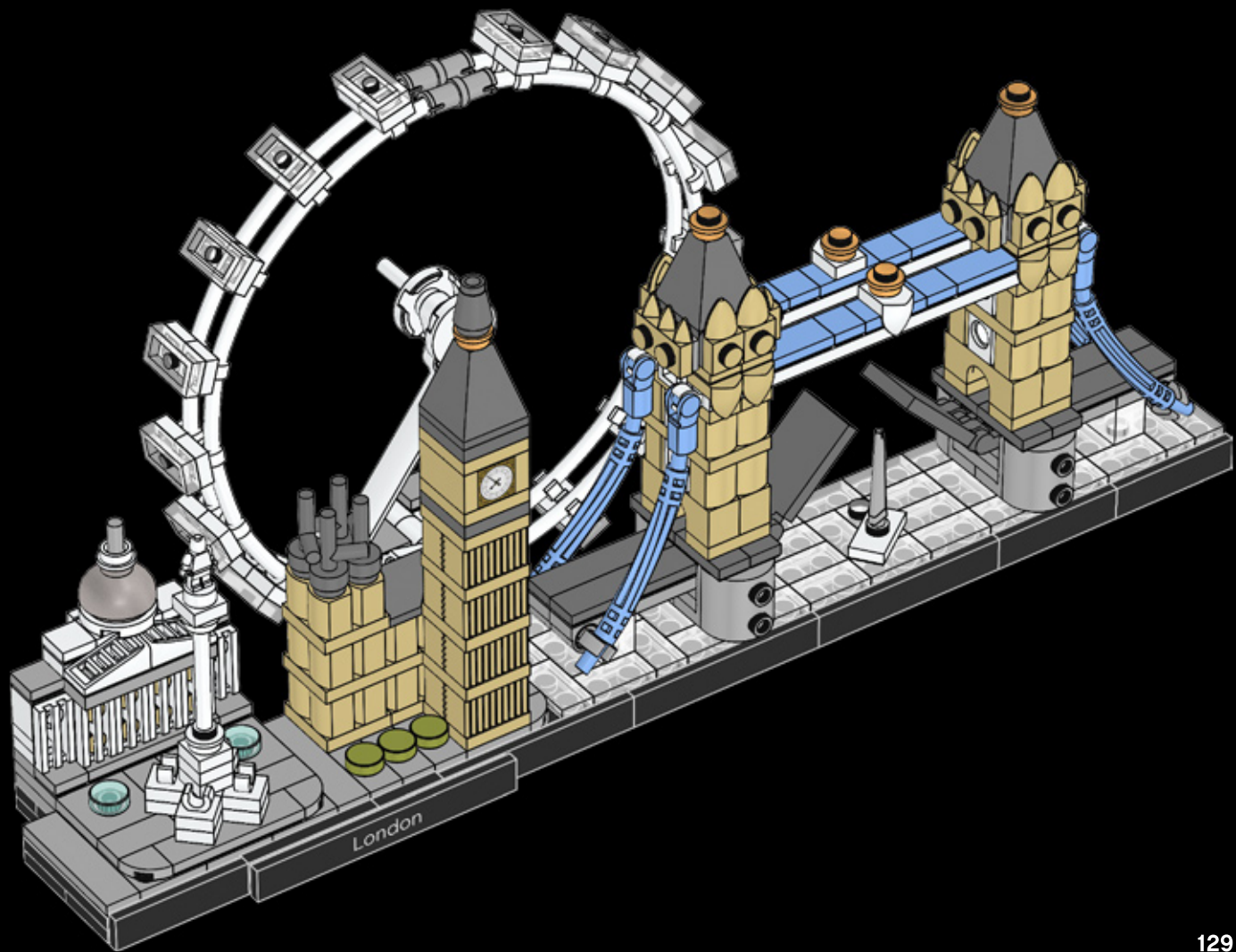



# LEGO® Architecture – do you like it?

The LEGO Group would like your opinion on the new product you have just purchased. Your feedback will help shape the future development of this product series.

Please visit:

**[LEGO.com/productsurvey](https://www.lego.com/productsurvey)**

By completing our short feedback survey, you will be automatically entered into a drawing to win a LEGO® prize.

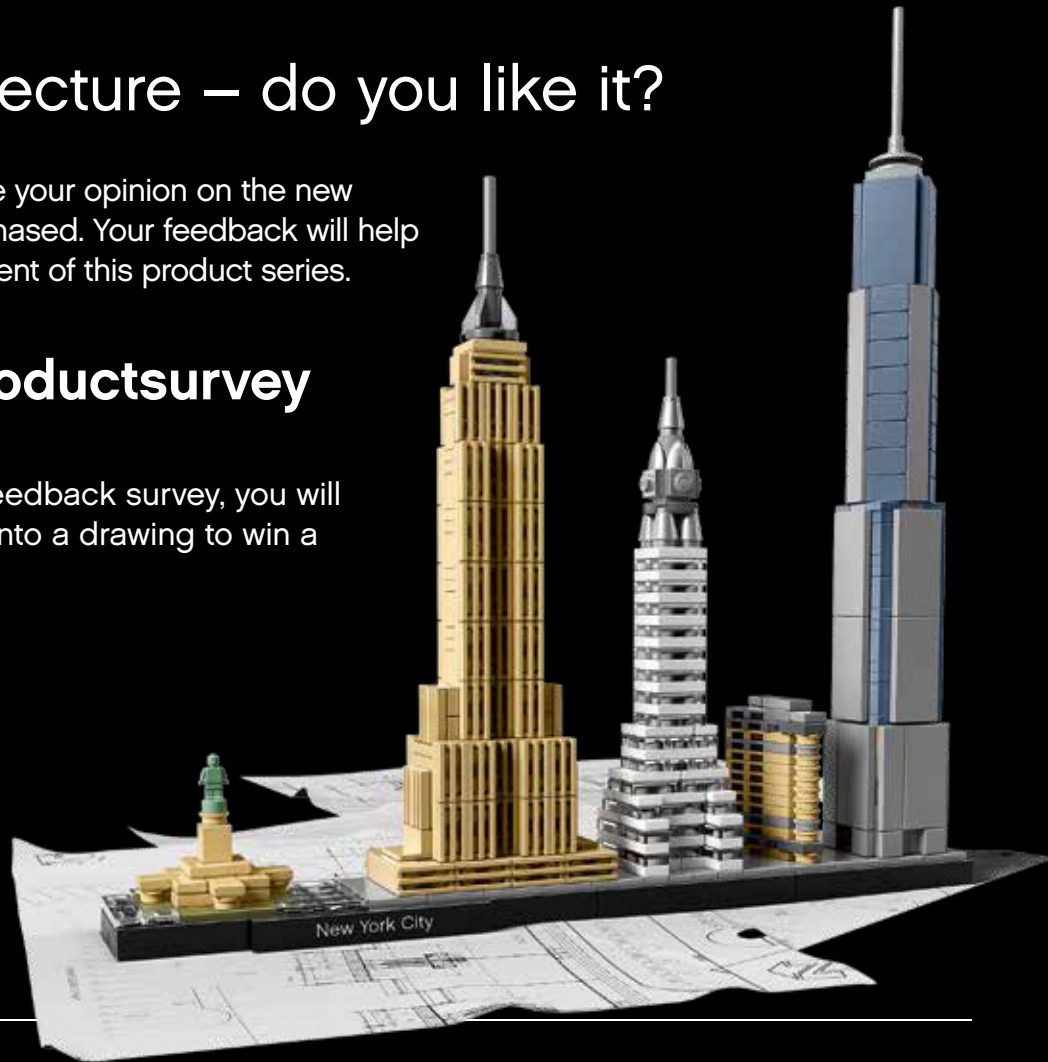

See website for official rules and details. Open to all countries where not prohibited.

LEGO and the LEGO logo are trademarks of the/son des marques de commerce du/son marcas registradas de LEGO Group.  
©2017 The LEGO Group.

# Aimez-vous LEGO® Architecture ?

Le Groupe LEGO aimerait connaître votre opinion sur le produit que vous venez d'acheter. Vos commentaires nous aideront à concevoir les futurs produits de cette gamme.

Rendez-vous sur :

**[LEGO.com/productsurvey](https://www.lego.com/productsurvey)**

En remplissant ce court sondage sur le produit, vous serez automatiquement inscrit à un tirage au sort pour gagner un prix LEGO®.



Consultez le site Web pour obtenir le règlement officiel et les détails. Ouvert à tous les résidents des pays autorisés.

LEGO and the LEGO logo are trademarks of the/son des marques de commerce du/son marcas registradas de LEGO Group.

©2017 The LEGO Group.

# LEGO® Architecture: ¿te gusta?

The LEGO Group quiere conocer tu opinión acerca del nuevo producto que acabas de comprar. Tus comentarios nos ayudarán a dar forma a los futuros productos de esta serie. Visita:

**[LEGO.com/productsurvey](https://www.lego.com/productsurvey)**

Al rellenar esta breve encuesta de opinión, participarás automáticamente en el sorteo de un producto LEGO®.



Consulta las reglas oficiales y demás información en el sitio web. Válido en todos los países en los que esta actividad no esté prohibida.

LEGO and the LEGO logo are trademarks of the/son des marques de commerce du/son marcas registradas de LEGO Group. ©2017 The LEGO Group.

## LEGO® Architecture—then and now

There has always been a natural connection between the LEGO® brick and the world of architecture. Fans who build with LEGO elements instinctively develop an interest in the form and function of the structures they create. At the same time, many architects have discovered that LEGO bricks are the perfect way of physically expressing their creative ideas.

This connection was confirmed in the early 1960s with the launch of the LEGO 'Scale Model' line. It matched the spirit of the age where modern architects were redefining how houses look and people were taking an active interest in the design of their new homes. These sets were designed to be different from the normal, brightly colored LEGO boxes; they also included a book on architecture as a source of inspiration.

Decades later, architect and LEGO fan Adam Reed Tucker, revived the idea of expressing architecture using LEGO bricks and in partnership with the LEGO Group, launched the LEGO Architecture line that we know today.

His first models, and the original sets in the current LEGO Architecture series, were interpretations of famous skyscrapers from his hometown of Chicago. Since then LEGO Architecture has developed and evolved, first with well-known buildings from other cities in the United States, and now with iconic structures from Europe, the Middle East and Asia.

The introduction of our LEGO Architecture Studio set echoes the ambitions of the earlier LEGO 'Scale Model' line and widens the potential of the LEGO Architecture series. Now you can enjoy building and learning about specific landmark buildings, or create exciting architectural models from your own fantasy. An inspiring 270-page book, featuring a number of renowned architects from around the world, guides you through the principles of architecture and encourages you in your own creative building.

## LEGO® Architecture – Hier et aujourd'hui

Il y a toujours eu une connexion naturelle entre la brique LEGO® et le monde de l'architecture. Les fans qui construisent avec des éléments LEGO développent instinctivement un intérêt pour la forme et la fonction des structures qu'ils créent. De nombreux architectes ont quant à eux découvert que les briques LEGO sont la façon idéale de matérialiser leurs idées de création.

Cette connexion a été confirmée au début des années 1960 avec le lancement de la gamme « Maquettes à l'échelle » LEGO. Cette gamme correspondait à l'esprit de l'époque, alors que les architectes modernes redéfinissaient les maisons, et que les gens s'intéressaient activement à la conception de leur résidence. Ces ensembles originaux étaient conçus pour être différents des boîtes LEGO habituelles aux couleurs vives, et incluaient aussi « un livret d'architecture » comme source d'inspiration.

Quelques décennies plus tard, l'architecte et fan de LEGO Adam Reed Tucker a fait revivre l'idée d'exprimer l'architecture en utilisant des briques LEGO. En partenariat avec le Groupe LEGO, il lança la gamme LEGO Architecture que nous connaissons aujourd'hui.

Ses premiers modèles, et les ensembles originaux de la gamme LEGO Architecture actuelle, étaient des interprétations de célèbres gratte-ciel de sa ville natale de Chicago. La gamme LEGO Architecture a depuis évolué et s'est élargie, tout d'abord avec des bâtiments célèbres d'autres villes des États-Unis, puis avec de célèbres monuments d'Europe, du Moyen-Orient et d'Asie.

L'introduction de notre ensemble LEGO Architecture Studio fait écho aux ambitions de la précédente gamme « Maquettes à l'échelle » LEGO et accroît le potentiel de la gamme LEGO Architecture. Vous pouvez maintenant découvrir et construire des monuments célèbres ou créer de passionnants modèles architecturaux nés de votre imagination. Un livret d'inspiration de 270 pages, présentant plusieurs architectes célèbres du monde entier, vous guide parmi les principes de l'architecture et vous encourage dans votre propre construction créatrice.

## LEGO® Architecture: entonces y ahora

Siempre ha existido una conexión natural entre el brick LEGO® y el mundo de la arquitectura. Los fans que construyen con elementos LEGO desarrollan instintivamente un interés por la forma y las funciones de las estructuras que crean. Al mismo tiempo, muchos arquitectos han descubierto que los bricks LEGO son una forma perfecta de expresar físicamente sus ideas creativas.

Esta relación se confirmó a principios de la década de 1960, con el lanzamiento de la línea «Scale Model» de LEGO. Encajaba bien con el espíritu de la época: un tiempo en el que los arquitectos modernos redefinían el aspecto de las casas y la gente se interesaba cada vez más por el diseño de su nuevo hogar. Los sets se diseñaron para que se diferenciaban de los normales, que se comercializaban en cajas de brillosos colores, e incluían un libro sobre la arquitectura que proporcionaba inspiración a sus usuarios.

Décadas más tarde, el arquitecto y fan de LEGO Adam Reed Tucker reavivó la idea de expresar la arquitectura usando bricks LEGO y, en colaboración

con The LEGO Group, lanzó la línea LEGO Architecture que hoy conocemos.

Sus primeros modelos, y los sets originales de la actual serie LEGO Architecture, eran interpretaciones de los rascacielos más famosos de su ciudad natal, Chicago. Desde entonces, LEGO Architecture se ha desarrollado y ha evolucionado, primero incorporando edificios célebres de otras ciudades de Estados Unidos y, ahora, estructuras emblemáticas de Europa, Oriente Próximo y Asia.

La introducción del set LEGO Architecture Studio recupera las ambiciones de la antigua línea «Scale Model» de LEGO y amplía el potencial de la serie LEGO Architecture. Hoy puedes disfrutar mientras construyes y aprendes sobre edificios célebres, o crear tus propios modelos arquitectónicos a partir de tu imaginación. Un instructivo libro de 270 páginas con materiales creados por arquitectos internacionales de gran reputación te guiará a través de los principios de la arquitectura y te animará a dar tus primeros pasos en el mundo de la construcción creativa.





21050  
Studio

Celebrate the world of architecture and collect all the models  
Célébrez le monde de l'architecture et collectionnez tous les modèles  
Celebra el mundo de la arquitectura y colecciona todos los modelos



21024  
Louvre

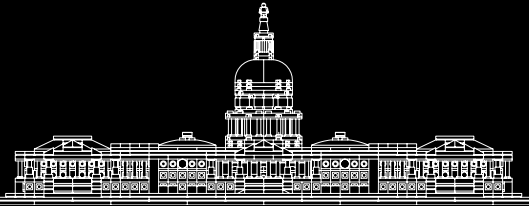

21030  
United States Capitol Building  
Le Capitole des États-Unis  
Edificio del Capitolio de Estados Unidos

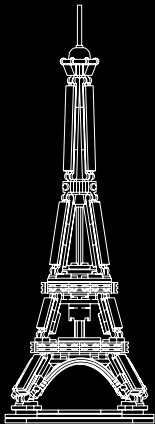

21019  
The Eiffel Tower  
La tour Eiffel  
La torre Eiffel

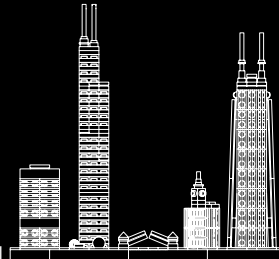

21033  
Chicago

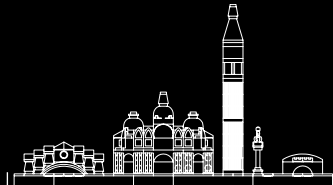

21026  
Venice  
Venise  
Venecia

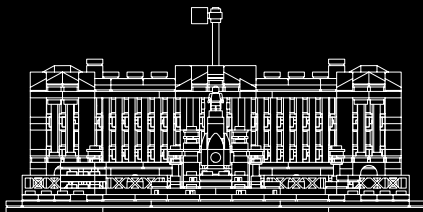

21029  
Buckingham Palace  
Le palais de Buckingham  
Palacio de Buckingham

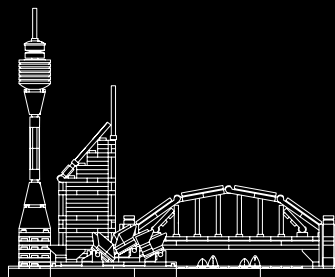

21032  
Sydney  
Sidney



21027  
Berlin  
Berlin  
Berlin



21028  
New York City  
New York  
Nueva York

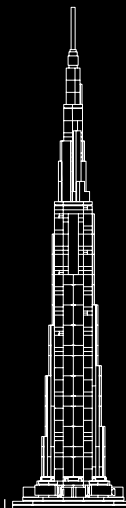

21031  
Burj Khalifa

1x  
6073432

3x  
6168642

36x  
6054551

6x  
407001

7x  
302401

4x  
654101

3x  
307001

2x  
6046905

2x  
6063767

4x  
4538353

3x  
6093053

4x  
6058177

6x  
241201

4x  
6051511

4x  
6057414

9x  
302301

2x  
6023804

1x  
6099412

3x  
6116602

1x  
6156667

2x  
6174941

2x  
447701

2x  
4612603

4x  
4159553

4x  
4125253

8x  
6143058

8x  
4224793

20x  
4218749

8x  
4655900

4x  
6092587

4x  
4113917

4x  
6046907

8x  
4114084

1x  
6175701

2x  
4121921

4x  
4618651

4x  
4118790

3x  
4114309

1x  
4143005

4x  
4121715

3x  
306926

12x  
302326

2x  
302226

1x  
6052126

3x  
302126

3x  
243126

5x  
371026

3x  
663626

2x  
379526

6x  
4653049



1x  
6174611



4x  
346026

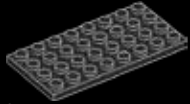

1x  
303526



4x  
244526



23x  
4167842



2x  
306540



40x  
4569297



4x  
6022171



4x  
6178242



4x  
4527526



2x  
6092601



4x  
4168345



4x  
6178243



4x  
4542590



4x  
6176433



7x  
4211415



4x  
4211807



9x  
4211414



6x  
6066097



7x  
4211398



4x  
6089147



4x  
4654580



4x  
4654582



1x  
6093527



2x  
6126082



8x  
4211397



1x  
4211353



4x  
6150310



1x  
4616840



4x  
4211356



4x  
4211395



3x  
4211452



1x  
4529240



4x  
4566028



1x  
6076203



1x  
4226221



1x  
6174938



8x  
6092572



4x  
6000606



2x  
4211094



3x  
4645099



4x  
4521187



4x  
4211053



2x  
4227517



5x  
4523159



1x  
6102756



3x  
6047015



4x  
6178597

## References:

*Pictures -*

© Shutterstock

*Text -*

[www.towerbridge.org.uk](http://www.towerbridge.org.uk)

[www.parliament.uk](http://www.parliament.uk)

[www.nationalgallery.org.uk](http://www.nationalgallery.org.uk)

[www.londoneye.com](http://www.londoneye.com)

## Références :

*Images -*

© Shutterstock

*Texte -*

[www.towerbridge.org.uk](http://www.towerbridge.org.uk)

[www.parliament.uk](http://www.parliament.uk)

[www.nationalgallery.org.uk](http://www.nationalgallery.org.uk)

[www.londoneye.com](http://www.londoneye.com)

## Referencias:

*Fotografías -*

© Shutterstock

*Texto -*

[www.towerbridge.org.uk](http://www.towerbridge.org.uk)

[www.parliament.uk](http://www.parliament.uk)

[www.nationalgallery.org.uk](http://www.nationalgallery.org.uk)

[www.londoneye.com](http://www.londoneye.com)

Customer Service  
Kundenservice  
Service Consommateurs  
Servicio Al Consumidor  
LEGO.com/service or dial

 00800 5346 5555 ;  1-800-422-5346 ; 



