



CITY

60389



1



Get excited about our new packaging!

We're switching from plastic to paper-based packaging. That's why you might find a mix of paper and plastic in our boxes!

Nos nouveaux emballages vous emballeront !

Nous passons des emballages en plastique aux emballages à base de papier. C'est pourquoi vous pourriez trouver un mélange de papier et de plastique dans nos boîtes !

¡Te presentamos nuestros nuevos empaques!

Estamos sustituyendo las bolsas de plástico por bolsas con base de papel. ¡Por eso, puedes encontrar una mezcla de papel y de plástico en nuestras cajas!

[LEGO.com/sustainable-packaging](https://www.lego.com/sustainable-packaging)



BUILDER



Apple and the Apple logo are trademarks of Apple Inc., registered in the U.S. and other countries and regions. App Store is a service mark of Apple Inc. Google Play and the Google Play logo are trademarks of Google LLC. Tencent and the Tencent logo are trademarks of Tencent Inc.

[LEGO.com/devicecheck](https://www.lego.com/devicecheck)

EN Ask parents' permission before going online | **DE** Eltern um Erlaubnis bitten, bevor du online gehst | **FR** Demande l'autorisation d'un parent avant d'aller en ligne | **IT** Chiedi il permesso ai tuoi genitori prima di andare online | **ES** Pídeles permiso a tus papás antes de conectarte a Internet | **PT** Pede autorização aos pais antes de acederes online | **JA** オンラインになる前に ほか者の方のきよかをもらおう | **ZH** 上网前应先征得父母的同意 | **KO** 온라인 접속 전에 보호자 동의가 필요합니다 | **RU** Спроси разрешения у родителей, прежде чем заходить в интернет | **PL** Poproś rodziców o zgodę, zanim wejdiesz do Internetu | **CS** Než půjdeš na internet, požádej rodiče o svolení | **SK** Skôr než pôjdeš na internet, vypýtaj si povolenie od rodičov | **HU** Kérj szülői engedélyt, mielőtt online csatlakoznál! | **RO** Cere permisiunea părinților înainte de a te conecta online | **BG** Поискайте разрешение от родител, преди да влезете онлайн | **LV** Pirms došanās tiešsaistē palūdz atļauju vecākiem | **ET** Enne Interneti kasutamist küsi vanematelt luba | **LT** Prieš prisijungdami prie interneto, atsklauskite tėvų

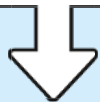
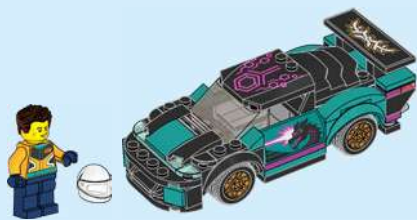
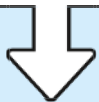

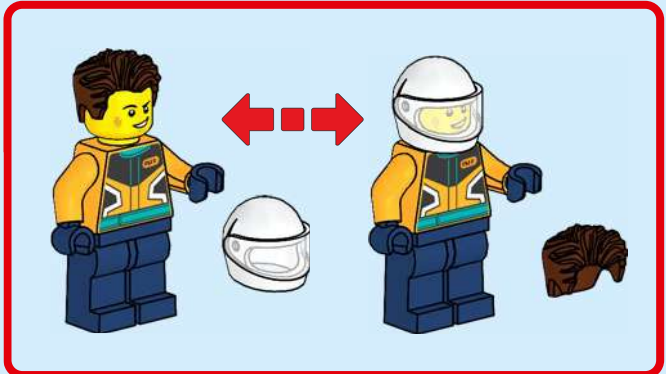

1

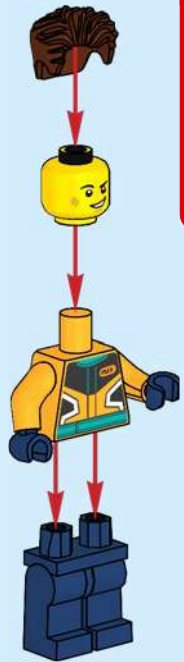

2

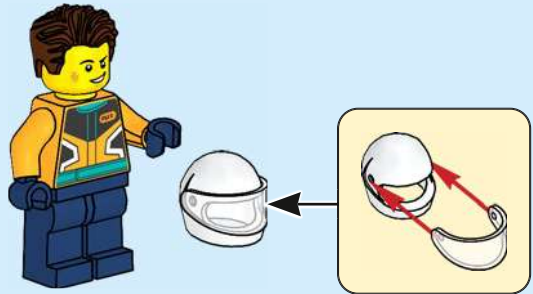

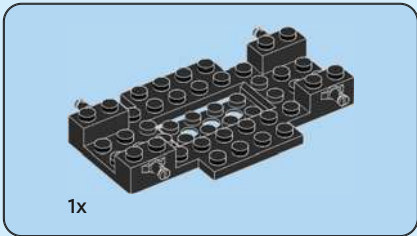
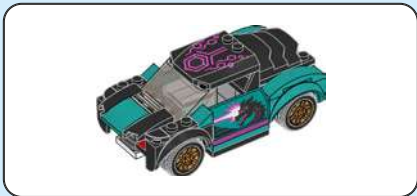

1

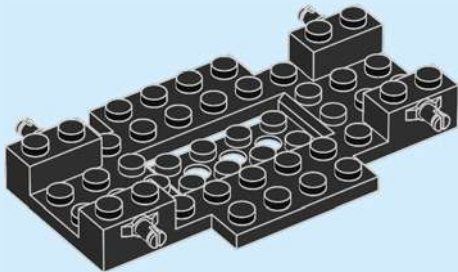

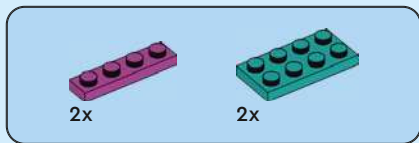

2

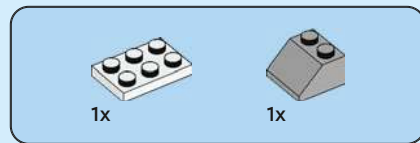
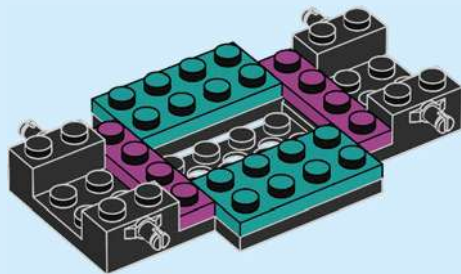

3

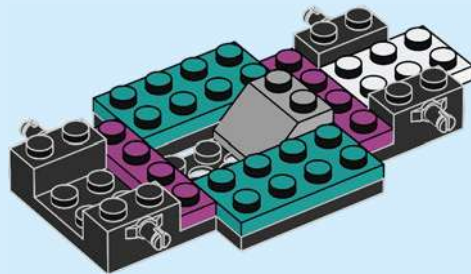

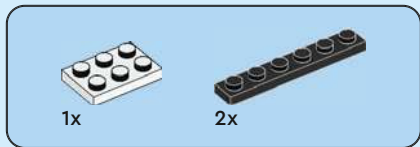

4

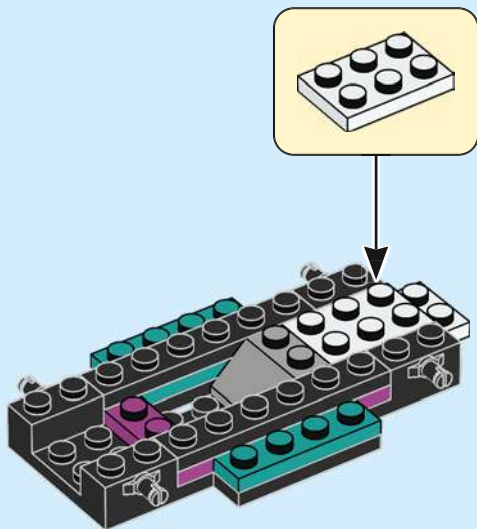



1x



1x

5

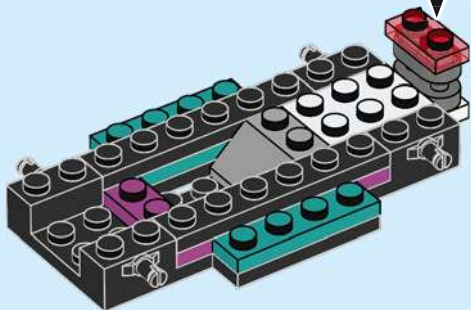
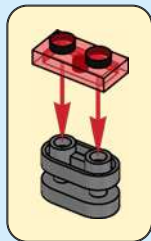

1x



1x

6

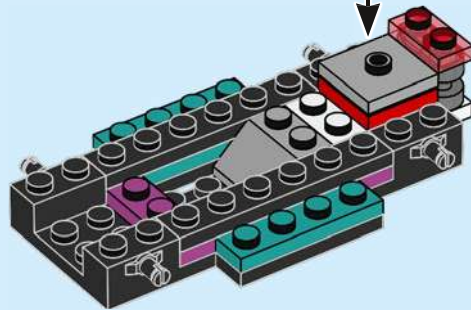
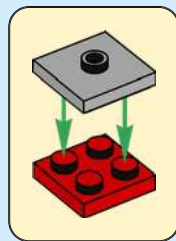



2x

7

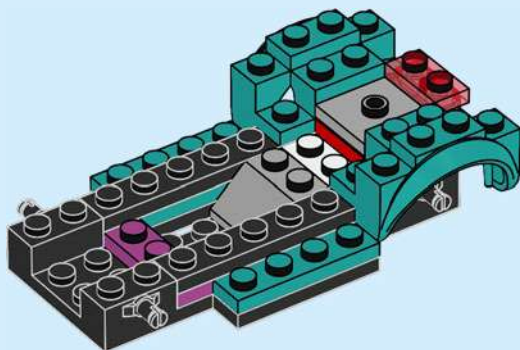



2x

8

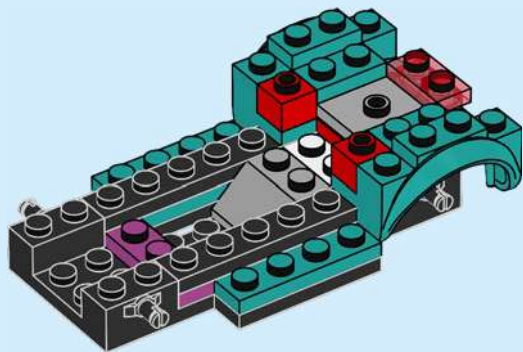

1x



2x

9

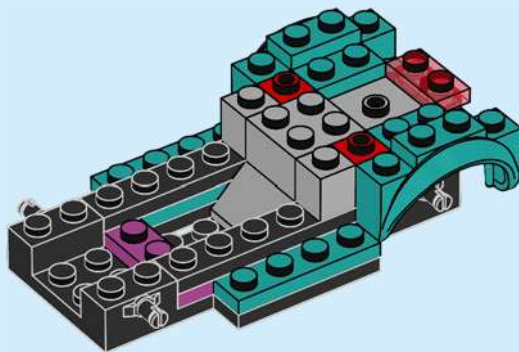

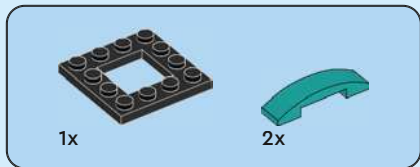

10

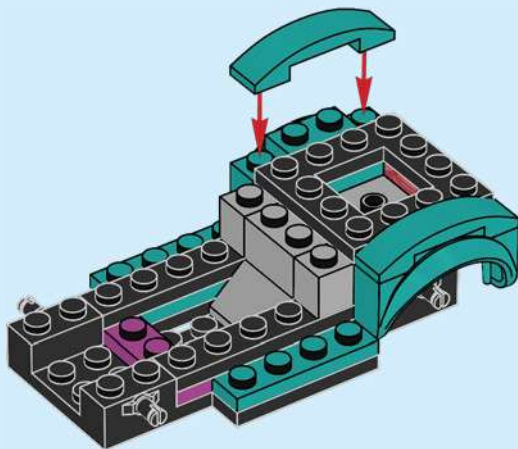



2x

11

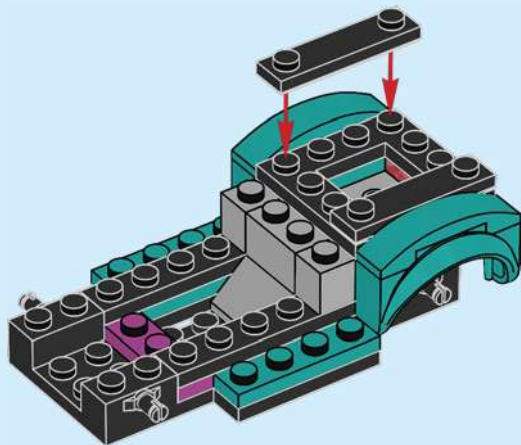

2x

12

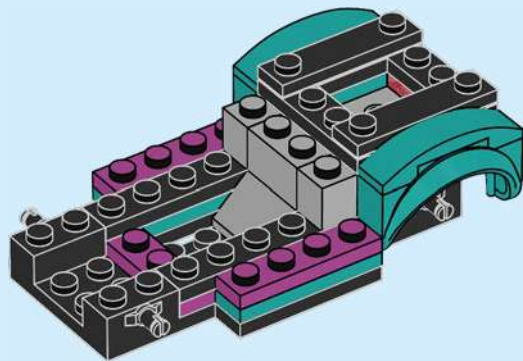



2x

13

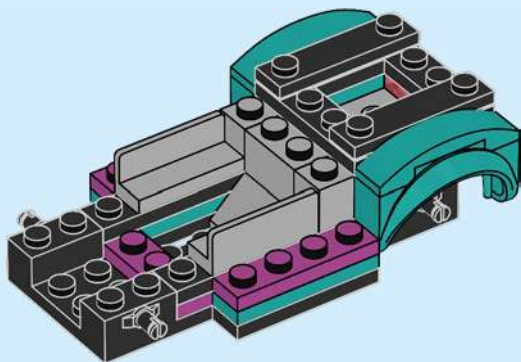

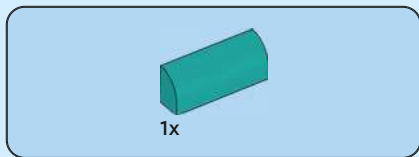

14

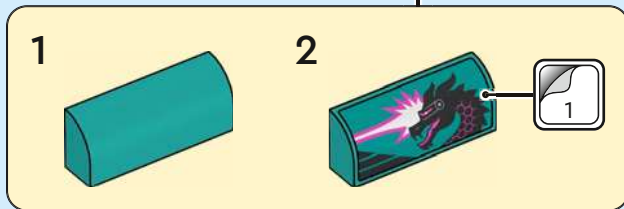
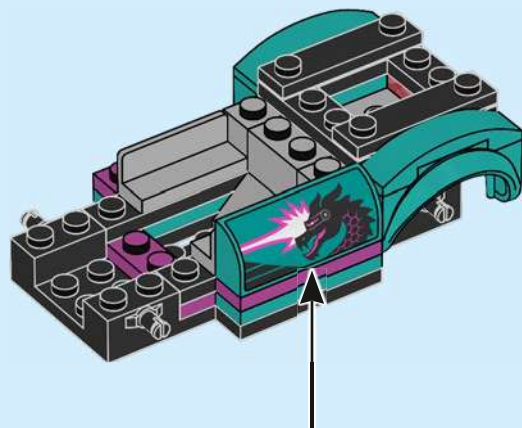

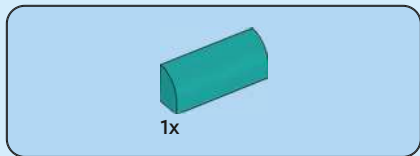

15

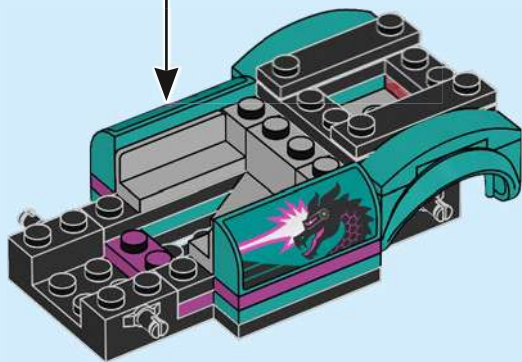
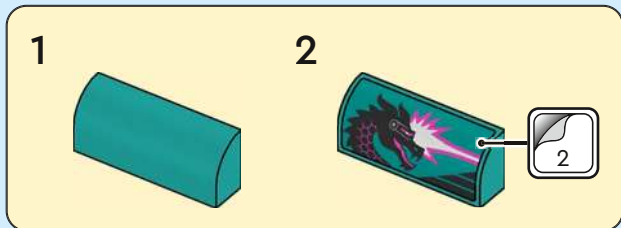



1x

16

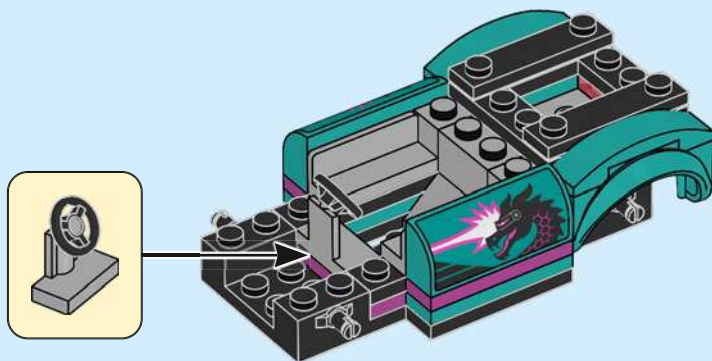

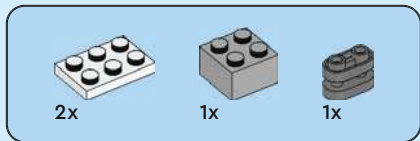

17

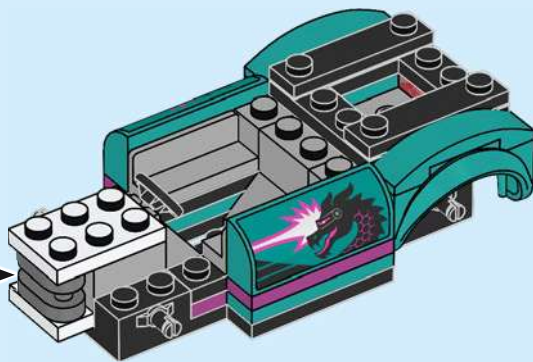
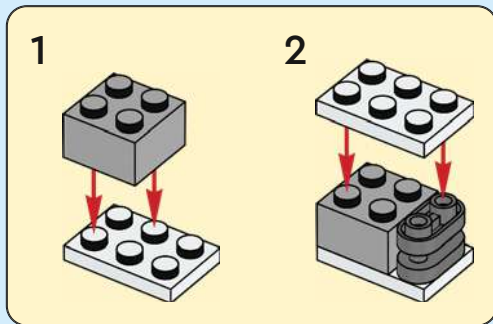



2x

18

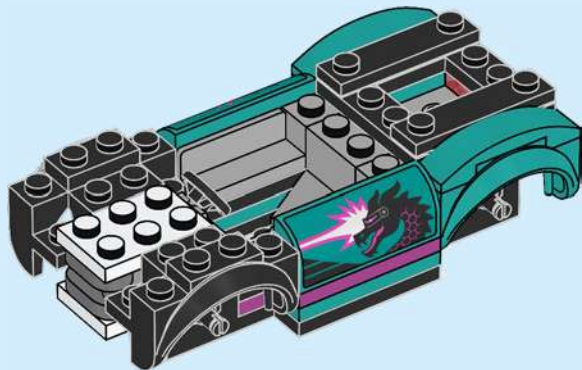

1x



2x

19

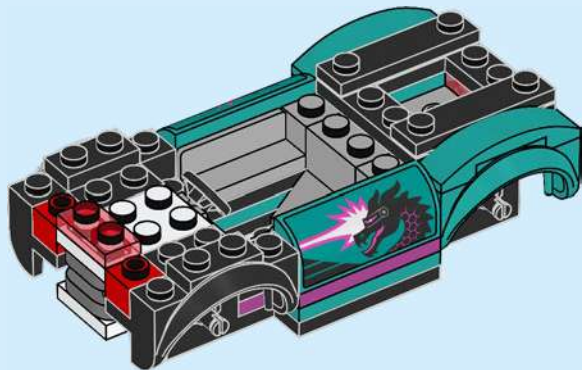



1x

20

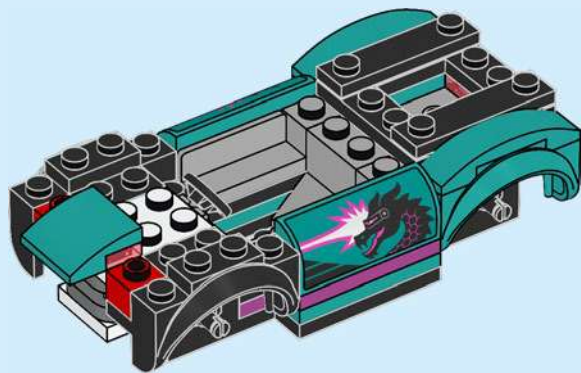

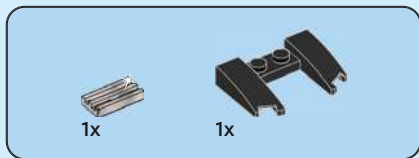

21

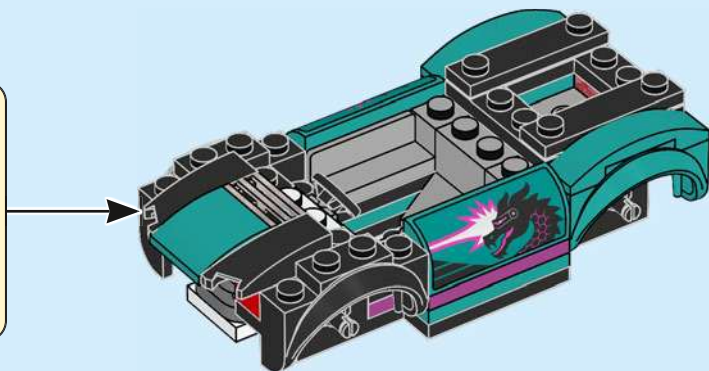
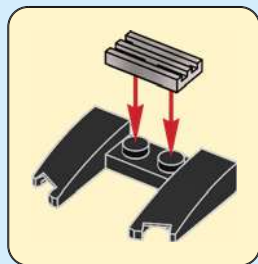



2x

22

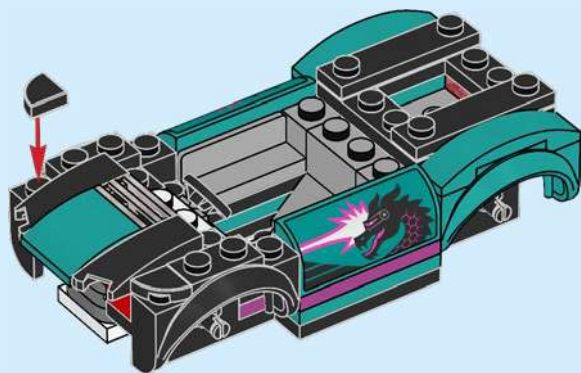

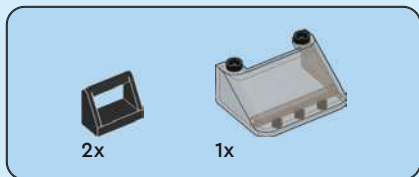

23

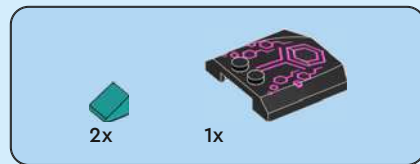
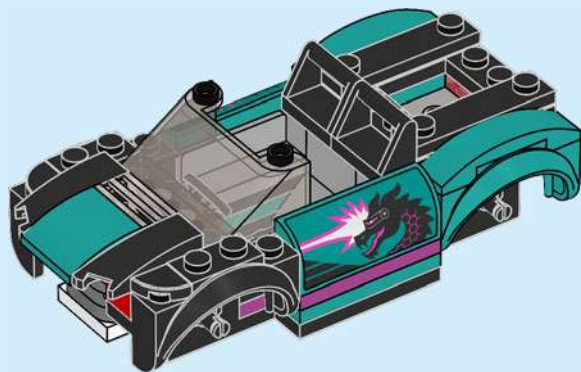

24

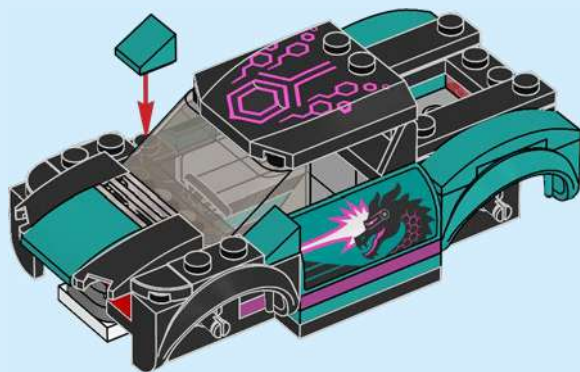

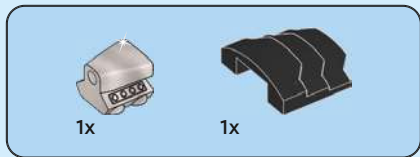

25

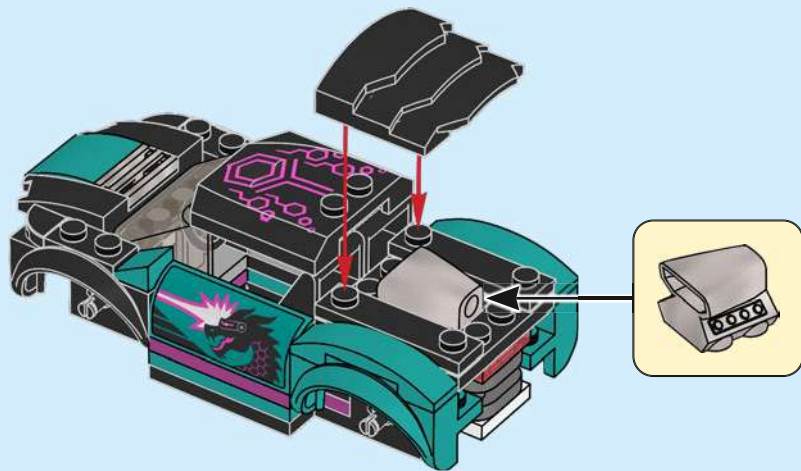

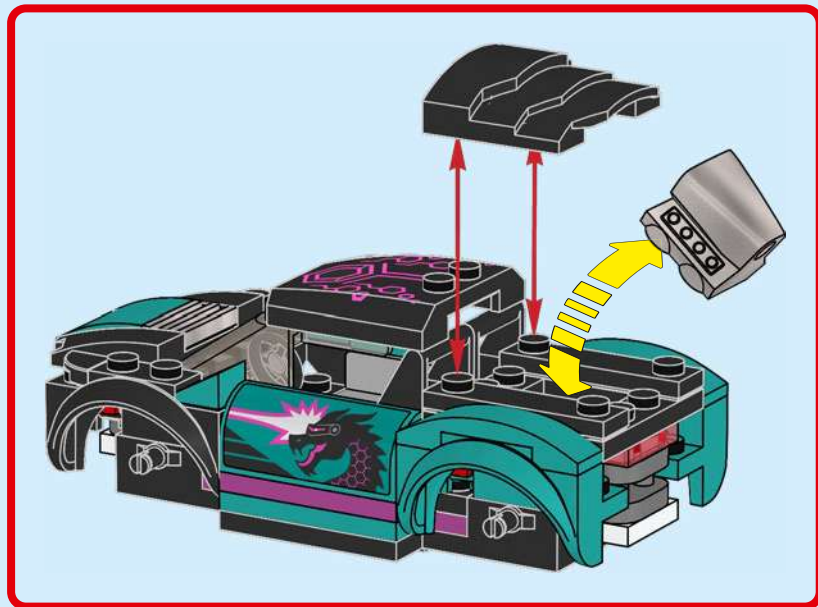



26

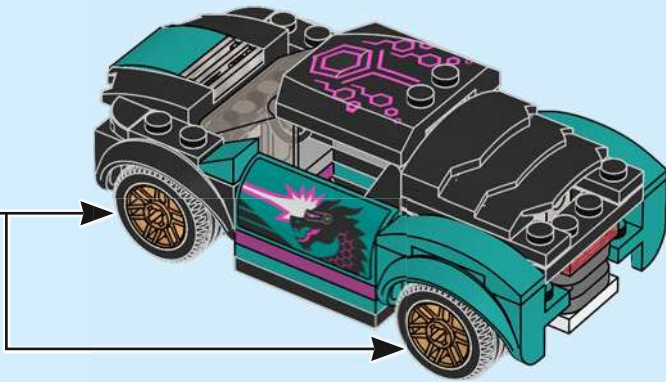
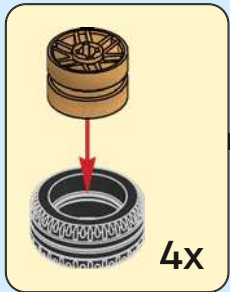

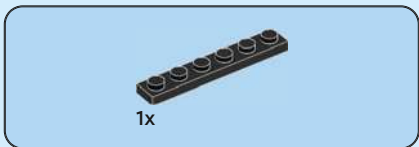

1



2





4x

3

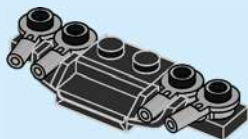

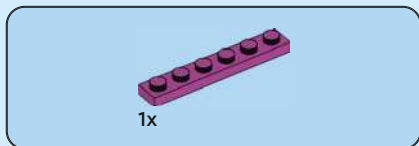

4

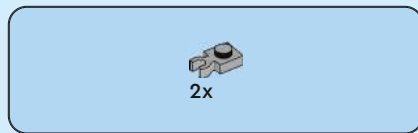
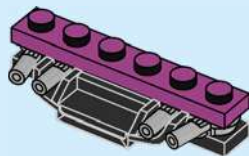

5

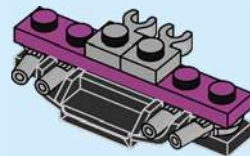



1x

6

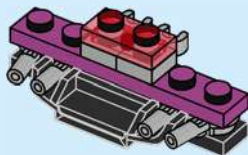



1x



2x

7

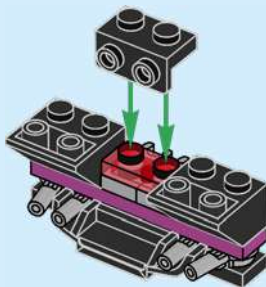

1x

8

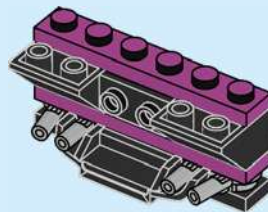



1x

9

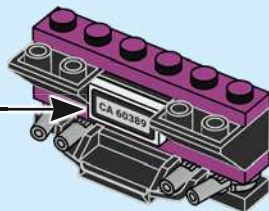
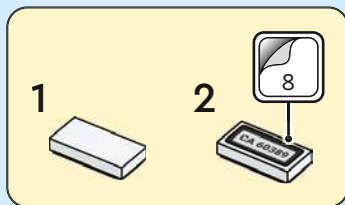



1x



2x

10

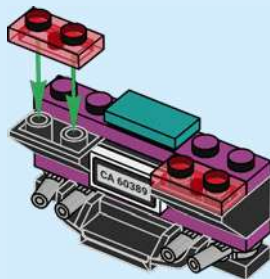

2x



2x

11

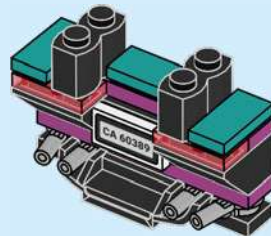

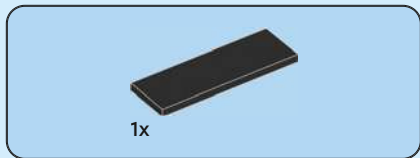

12

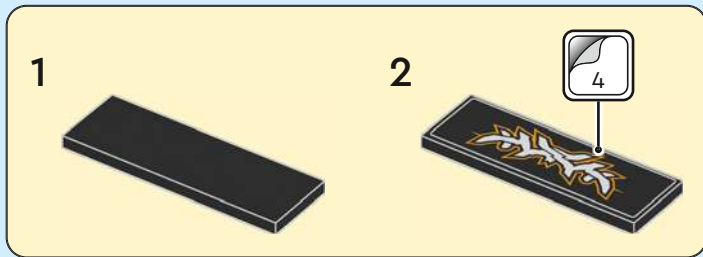



1x

1





1x

2

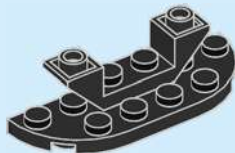

1x

3

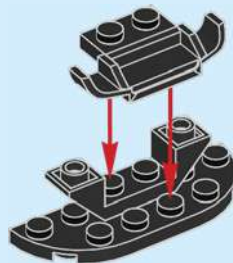



2x

4

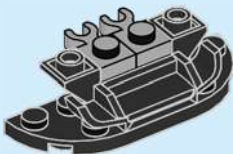



2x

5

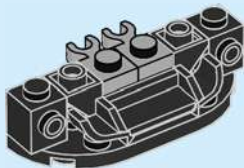

1x

6

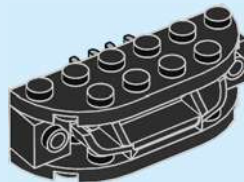



2x

7

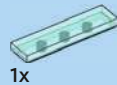
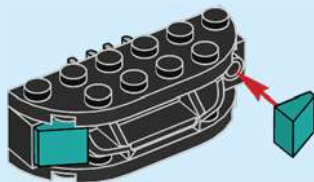

1x



2x

8

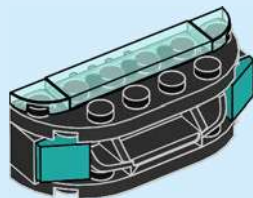

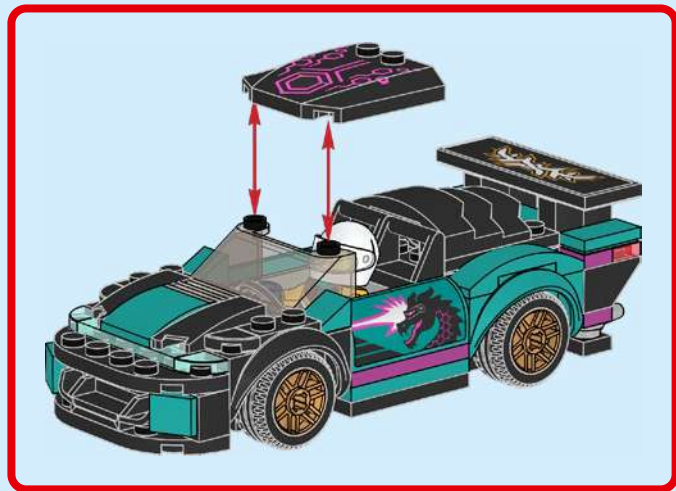

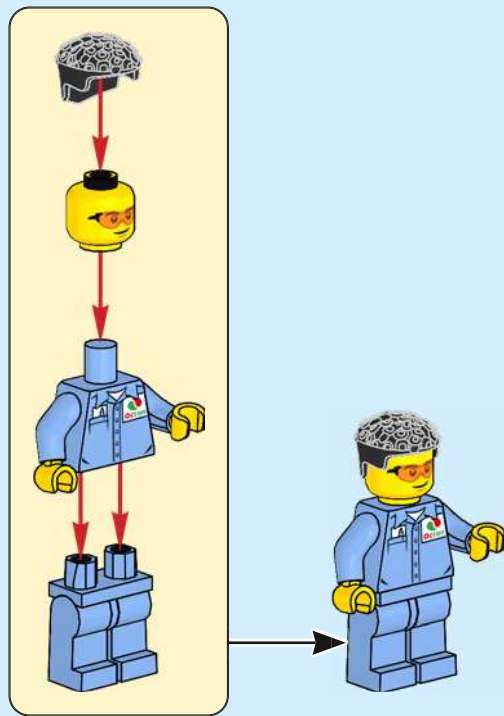



1x

1





1x

2



2x

3

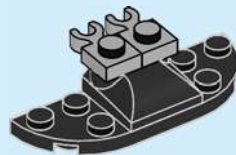



2x

4

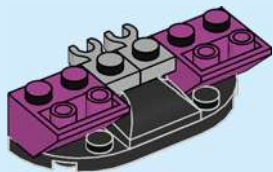

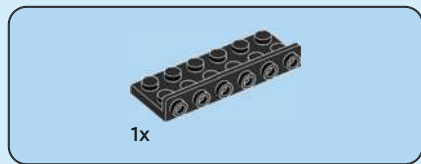

5

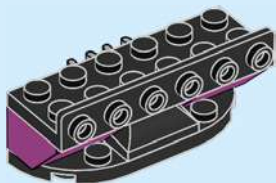

6

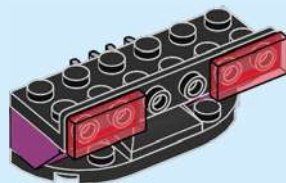



1x

7

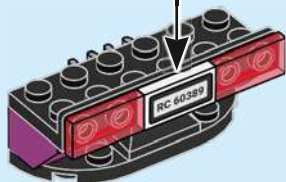
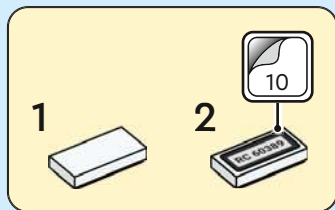

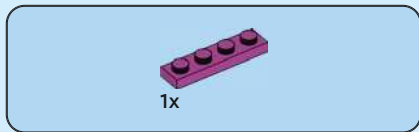

8



9

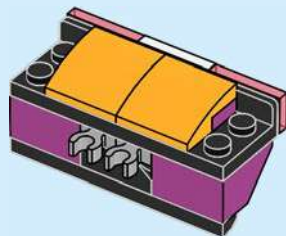



2x

10

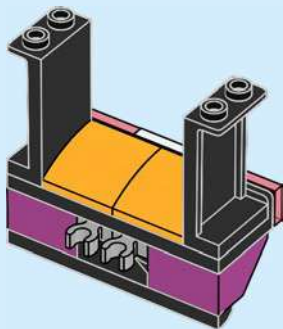

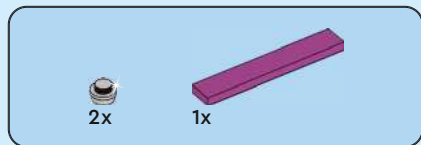

11

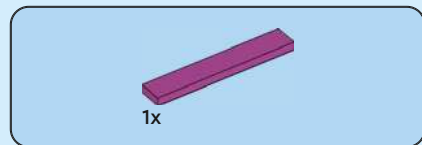
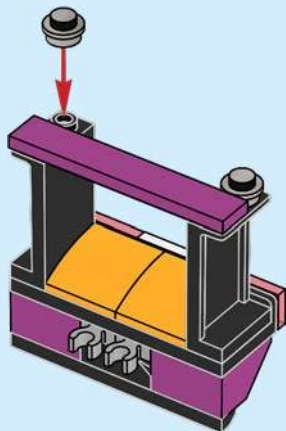

12

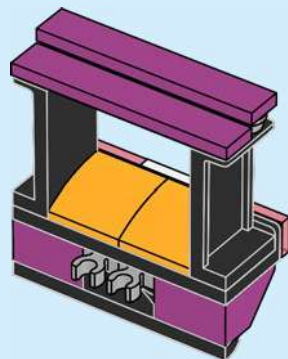

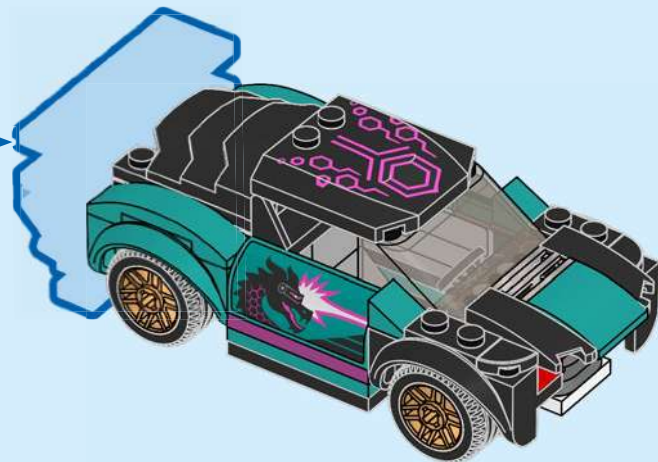
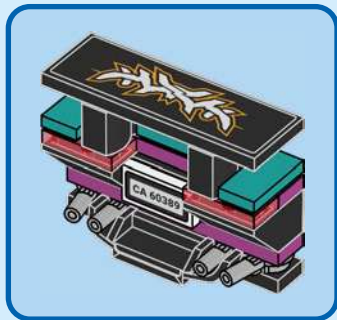
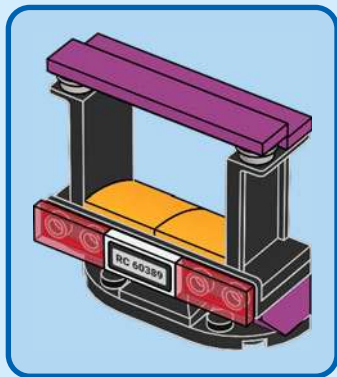

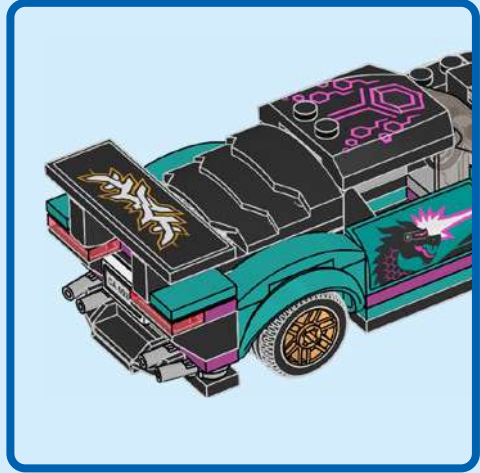
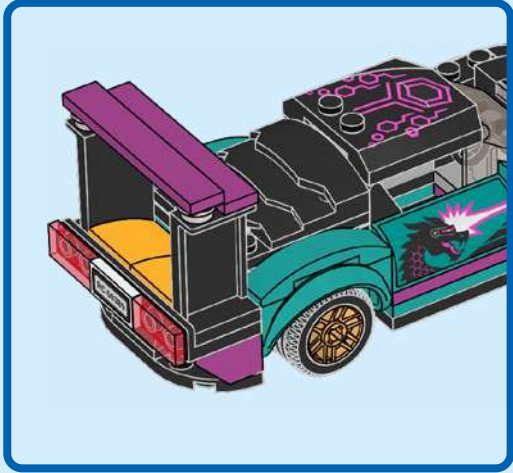

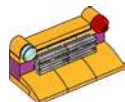

1x

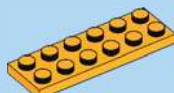

1x

1

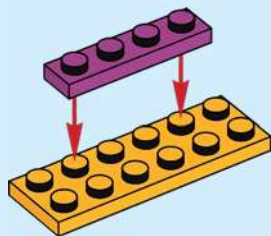



3x

2

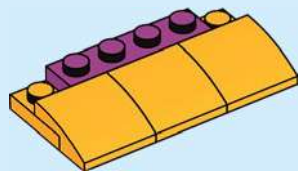

2x

3

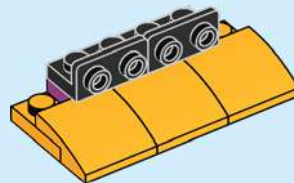



2x



2x

4

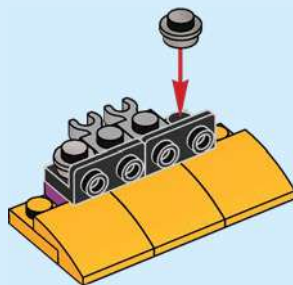



2x

5

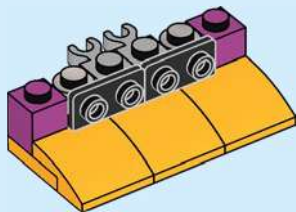

1x



2x

6

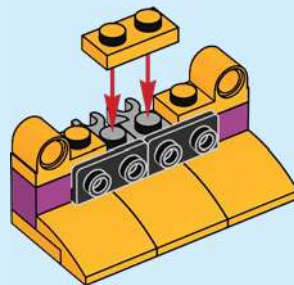

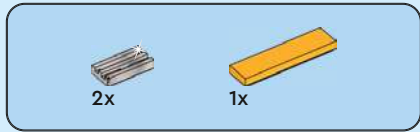

7

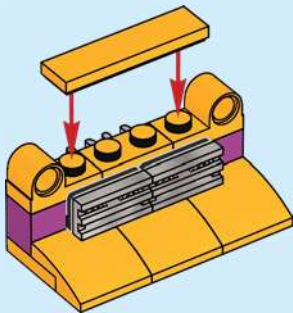



2x

8

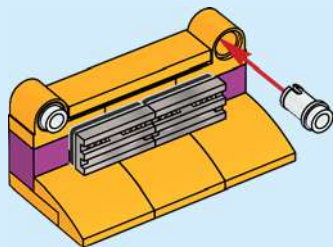

1x



1x

9

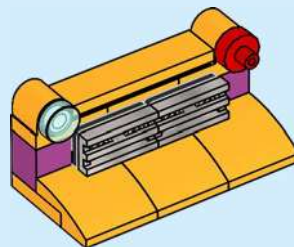

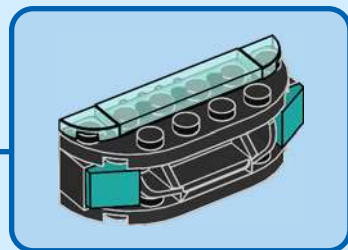
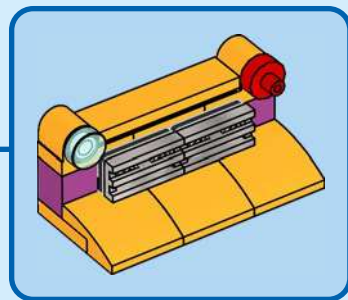
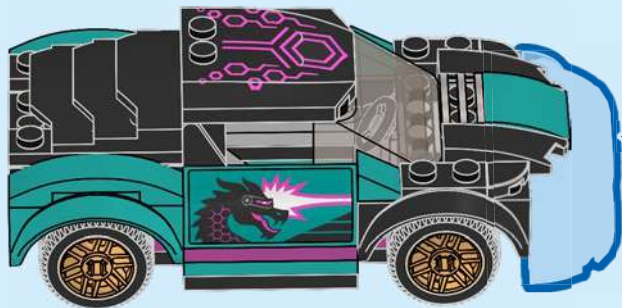

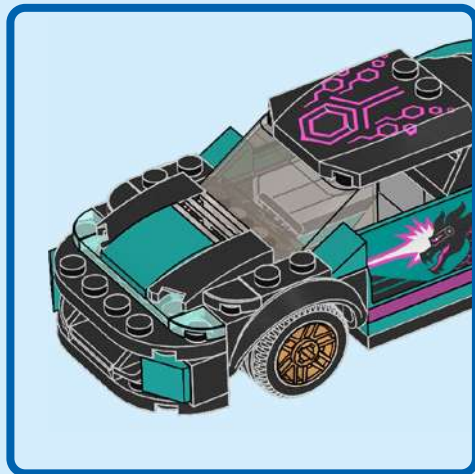
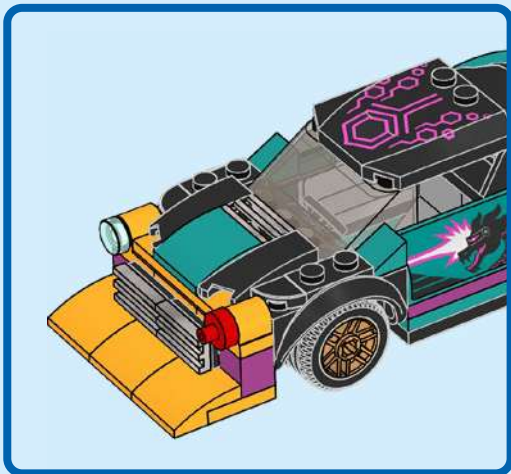

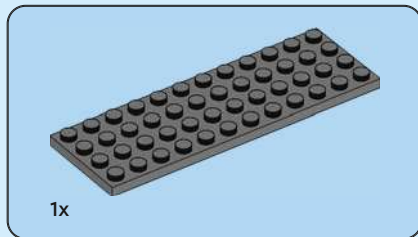

1

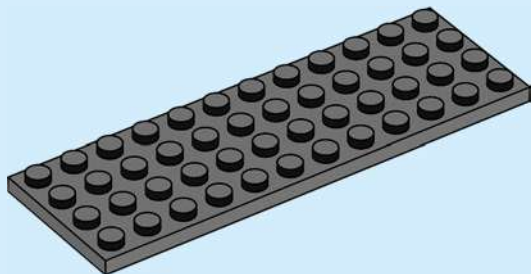

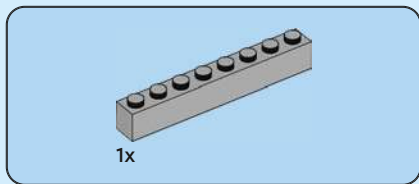

2

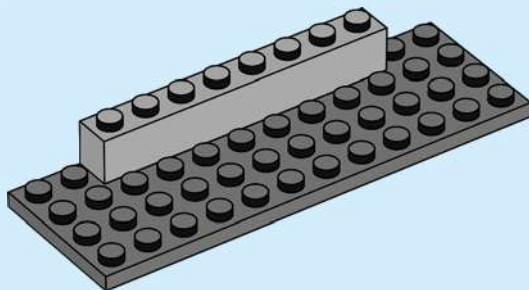

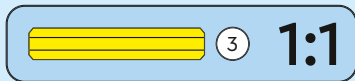
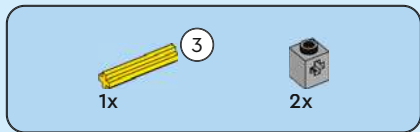

3

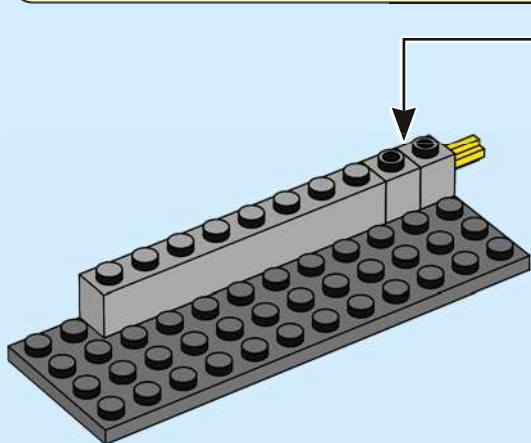



2x

4

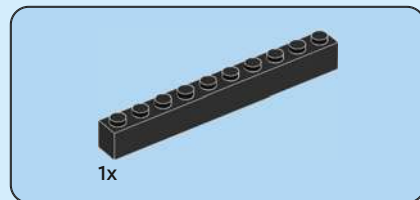
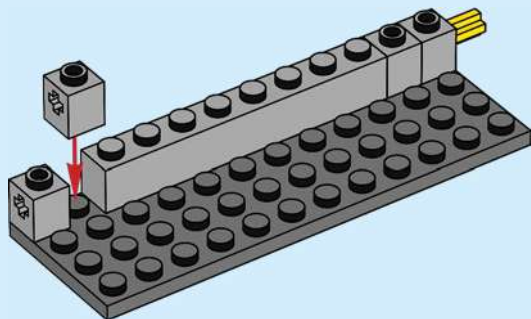

1x

5

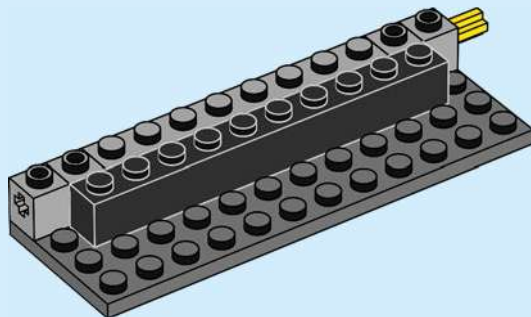

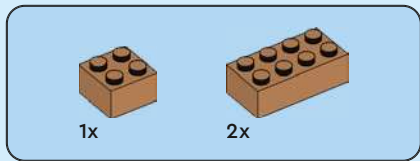

6

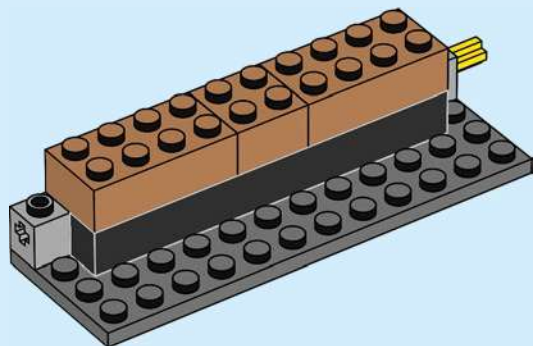

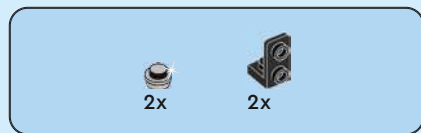

7

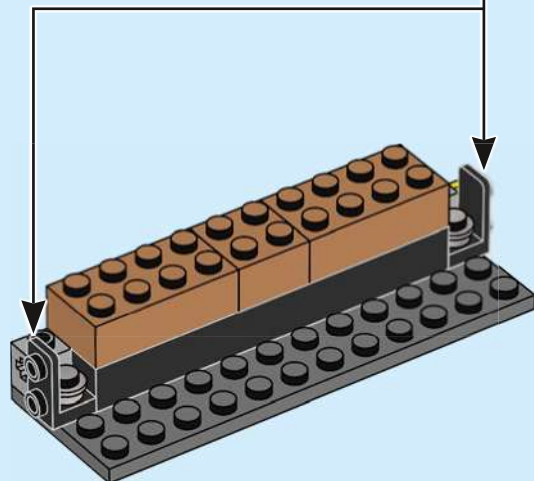
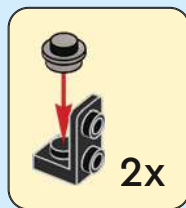

8

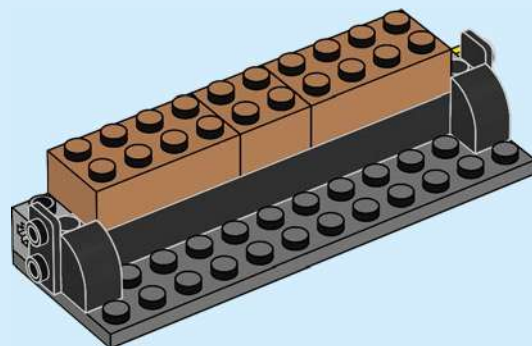



9

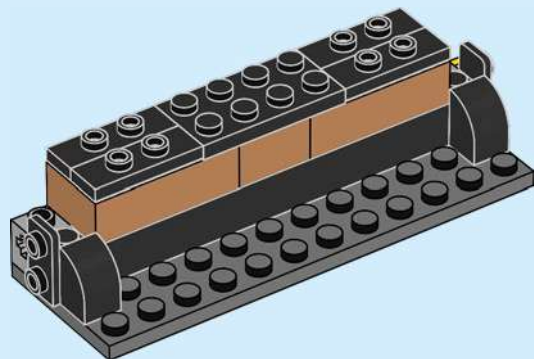



10

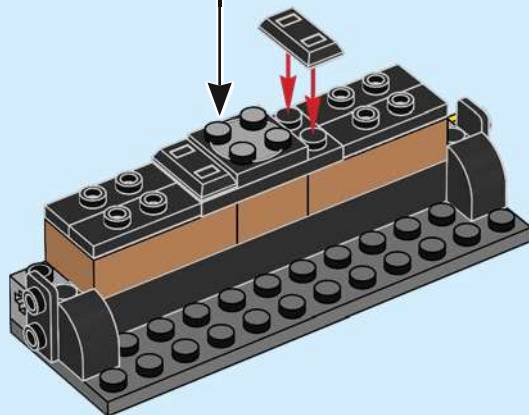
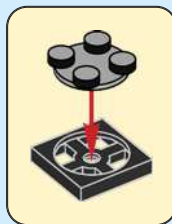

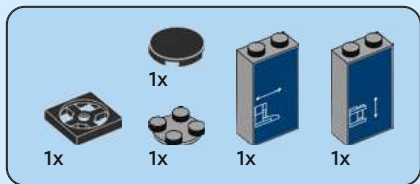

11

1



2



3



4

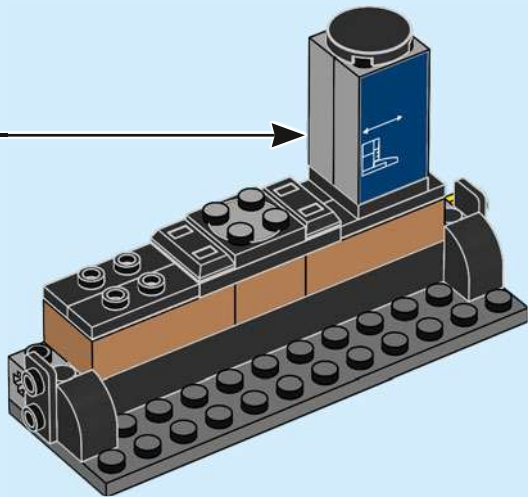
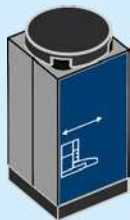

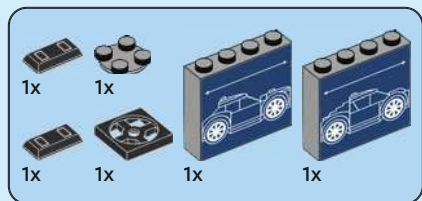

12



1

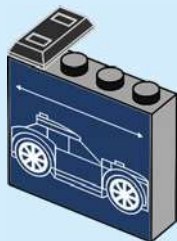

2

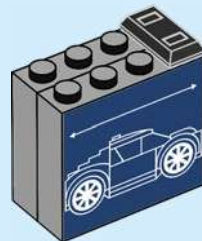

3

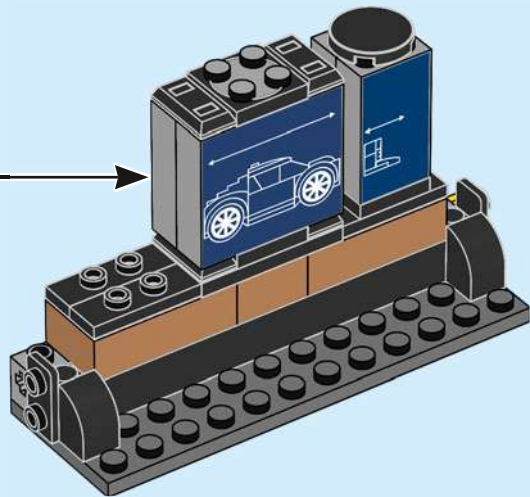
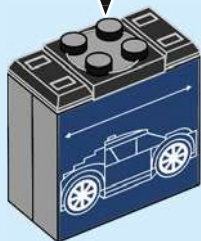
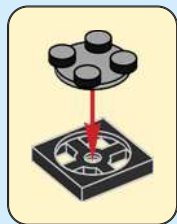

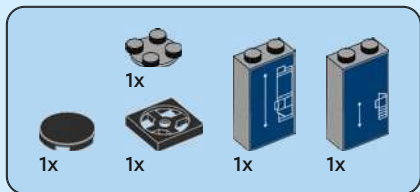

13

1



2

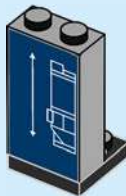

3



4

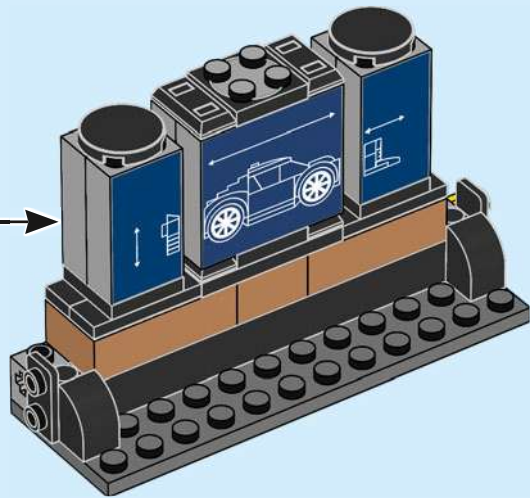
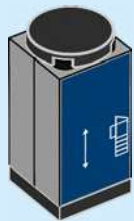

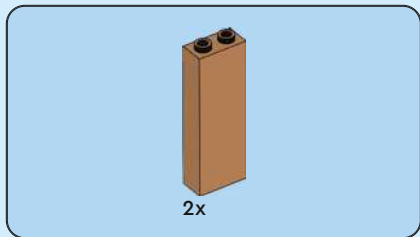

14

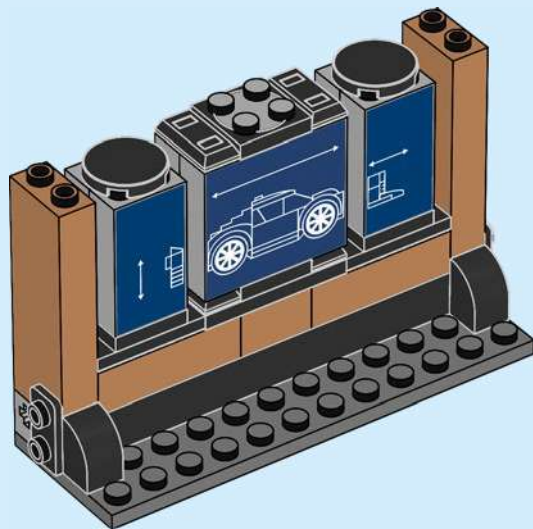

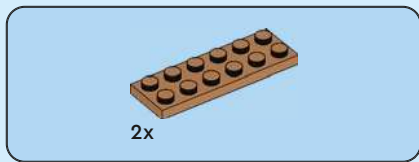

15

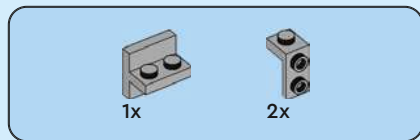
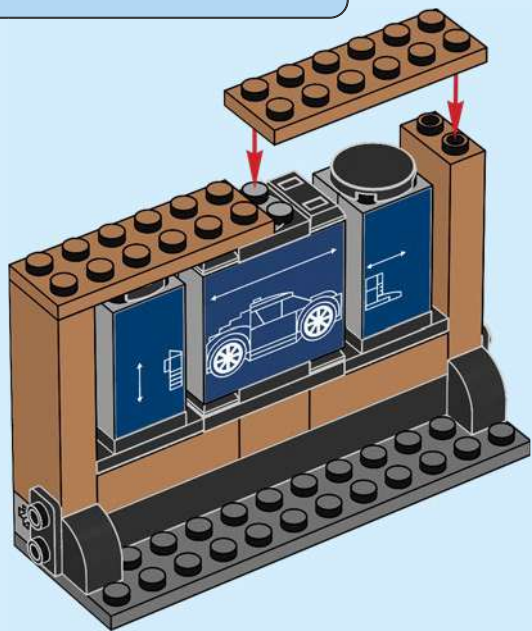

16

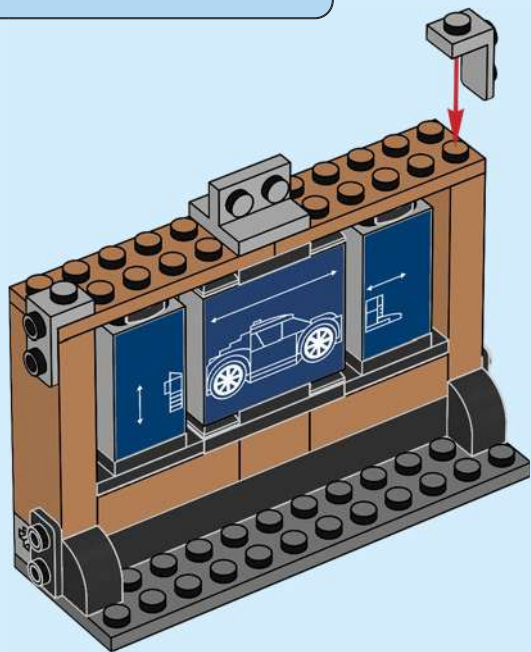

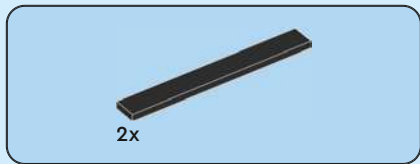

17

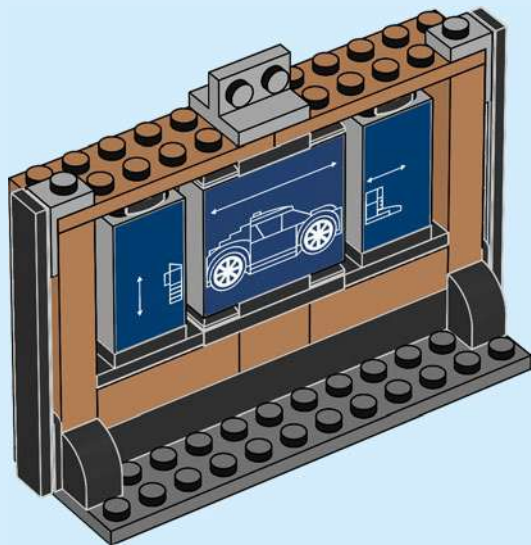

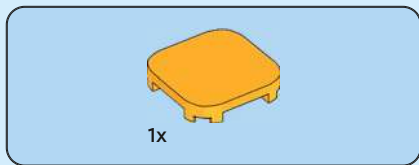

18

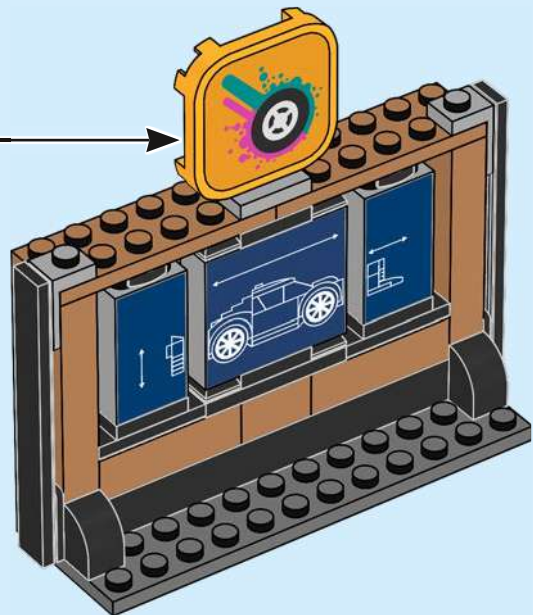
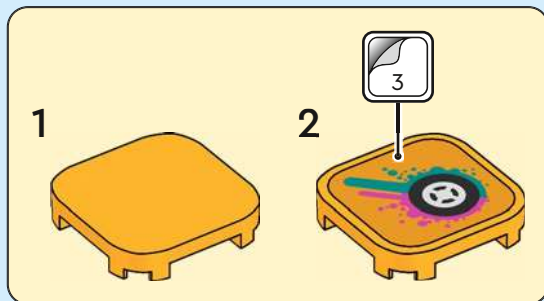



19

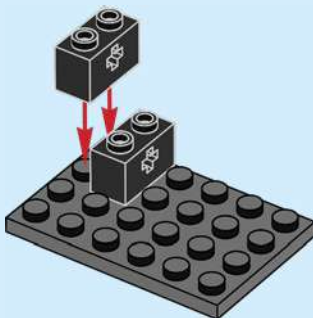



20

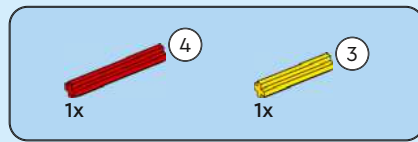
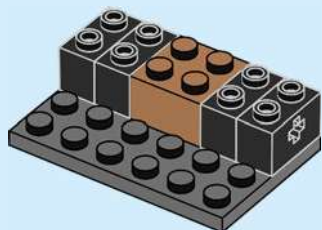

21

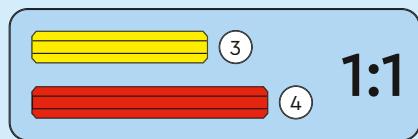
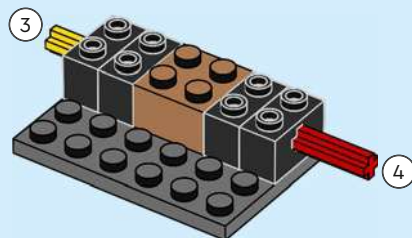



1x

22

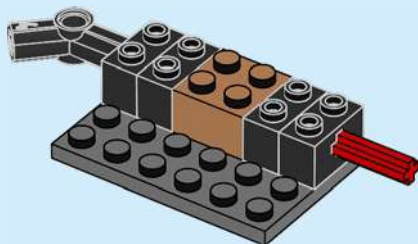



23

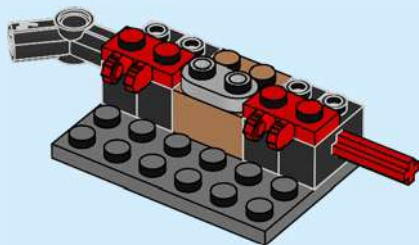

24

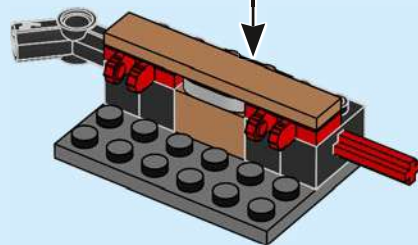
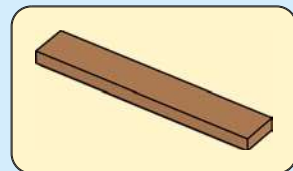

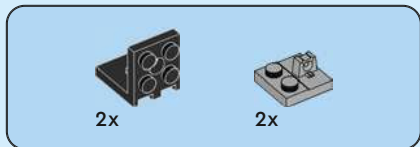

25

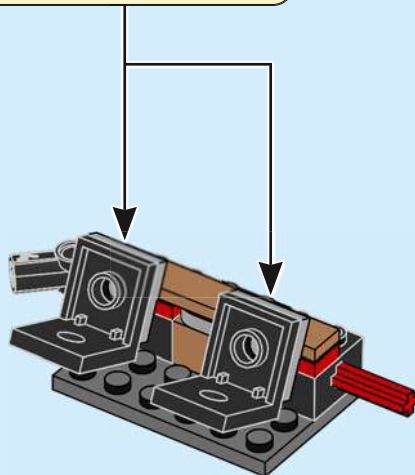
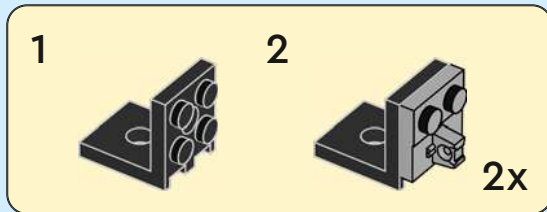

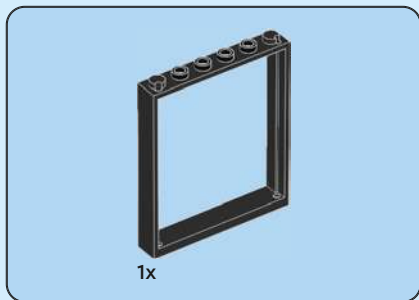

26

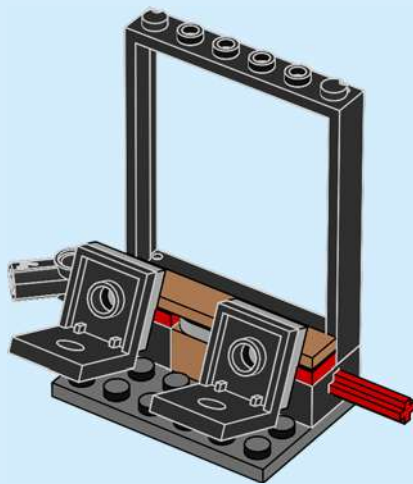



1x



2x

27

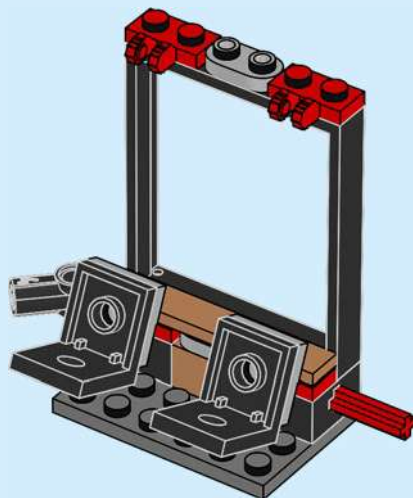

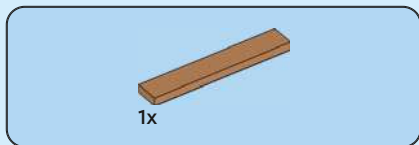

28

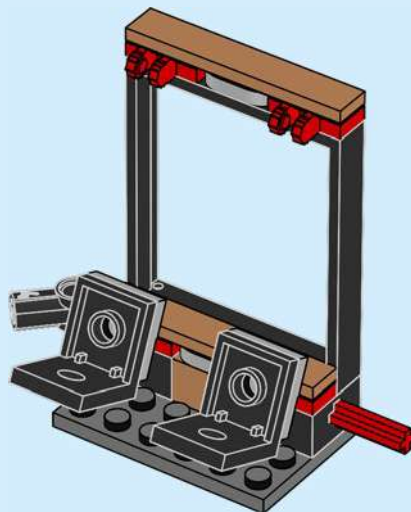

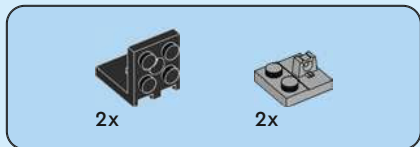

29

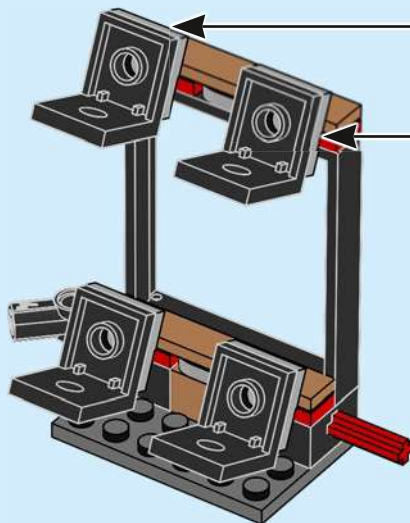
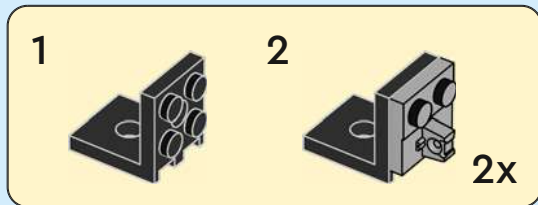

30

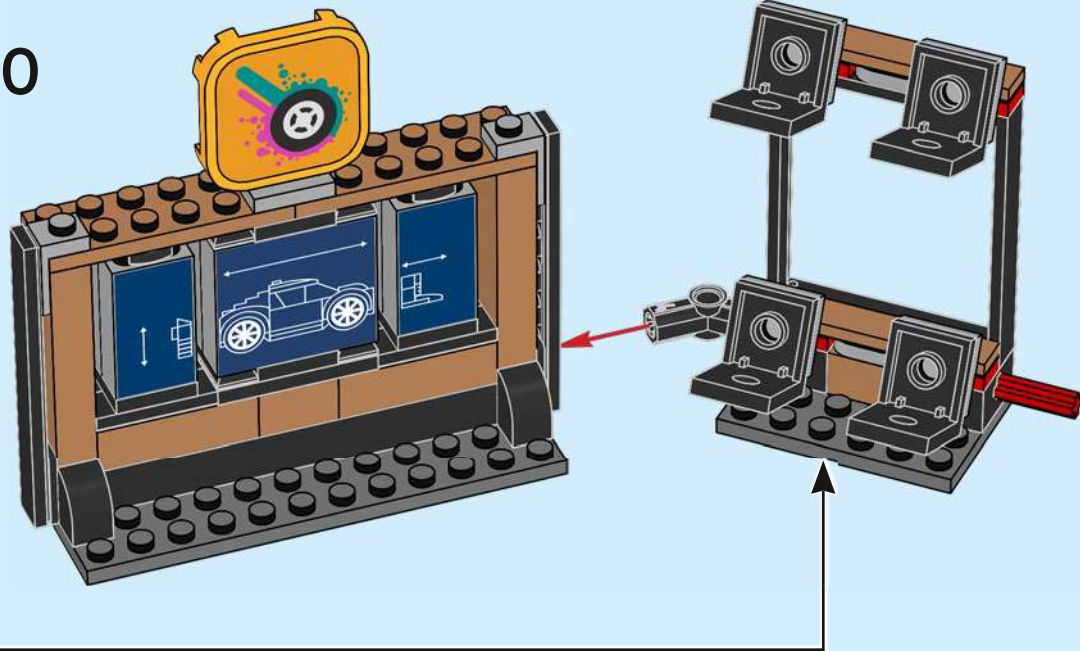



CITY



60387



60389



60383



60384

60385

1x 6325955	2x 6338181	4x 4654105	6x 6092035	2x 6244787	1x 4298617	4x 6130007	
4x 6278172			1x 6024286	1x 6274739	1x 4651524	3x 6266283	2x 6186400
3x 6228967	2x 6336510	2x 6102821	1x 6028736	6x 6396287	8x 6266205		3x 6058085
3x 6213779	1x 6172869	2x 6421680	2x 6310196	1x 6252049	4x 6053011	1x 6400771	5x 6135191
2x 6249418	2x 6022035	2x 6316439	5x 6099730	3x 6247359	1x 393721	1x 6176636	4x 6102995
1x 6223665	1x 6177349	1x 6097509	1x 6430415	2x 6129995	1x 6029946	1x 6223923	2x 6313600
1x 6310580	1x 6430396	3x 6072668	2x 6023173	1x 302021	1x 302221	1x 6283884	4x 6360035
2x 6249299	1x 6419156	2x 6422296	4x 6214457	4x 4560179	2x 6126048	1x 6329589	
2x 6217667	2x 6172860	2x 6097511	4x 6258607	2x 6335578	1x 4619543	1x 6079007	1x 6226644
	14x 6037652		2x 6251290				
			7x 6240212				

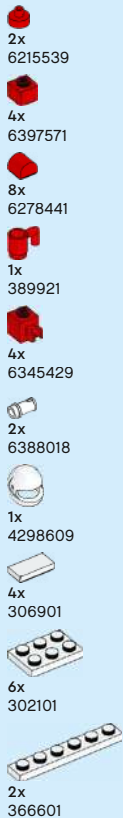



2x
383226



2x
6285534



1x
611126



2x
4211115



1x
4211061



2x
4211067



1x
4210706



1x
4529240



1x
6263570



5x
6390673



1x
6116470



2x
6352600



1x
6338470



1x
4211420



2x
4211392



4x
6227897



16x
6296894



2x
6152344



4x
4540203



2x
4211807



4x
4211383



2x
6168633



1x
6326078



2x
4211469



1x
6422508



1x
6419133



1x
6419134



1x
6419121



1x
6132390



2x
6258820



2x
4211387



1x
4211410



4x
6126082



9x
6265742



1x
6338962



4x
6210581



1x
4217918



1x
4211394



1x
6430408



1x
4162916



1x
4162916



4x
6258831



2x
4211389



4x
6336539



2x
6362975



7x
6248890



4x
6419140



1x
6430408



1x
4162916



4x
6268401



15x
4633691



3x
4619636



2x
6076604



1x
6103444



2x
6047056



1x
6267919



1x
4653267



1x
6267760



 [LEGO.com/service](https://www.lego.com/service)

YOU COULD **WIN**



Scan this QR code or go to **LEGO.COM/PRODUCTFEEDBACK** and give us your short feedback about this LEGO® set for a chance to win a cool LEGO prize.

Terms and Conditions apply*

DE: Du könntest GEWINNEN. Es gelten die Teilnahmebedingungen* **FR: Tu pourrais GAGNER.** Des conditions s'appliquent* **IT: Potresti VINCERE tu.** Termini e condizioni sono applicabili* **ES: Puedes GANAR.** Aplican términos y condiciones* **PT: Poderá GANHAR.** Aplicam-se termos e condições* **JA: プレゼント付き! 利用規約が適用されます*** **ZH: 轻松获奖. 条款和条件适用*** **KO: 상품의 주인이 되어보세요. 소정의 약관이 적용됩니다*** **RU: Вы можете ВЫИГРАТЬ.** Действуют положения и условия* **PL: Szansa na WYGRANĄ.** Obowiązują warunki korzystania* **CS: Máte šanci VYHRÁT.** Platí všeobecné smluvní podmínky* **SK: Máte šancu VYHRAŤ.** Platia všeobecné zmluvné podmienky* **HU: TE IS NYERHETSZ.** Felhasználási feltételek érvényesek* **RO: Ai putea CÂȘTIGA.** Se aplică termeni și condiții* **BG: Можете да СПЕЧЕЛИТЕ.** Има определени правила и условия* **LV: Tu vari LAIMĒT.** Ir spēkā noteikumi un nosacījumi.* **ET: Sul on võimalus VÕITA.** Kehtivad tingimused* **LT: Jūs galite LAIMĖTI.** Taikomos sąlygos*

*LEGO.com/productfeedback-terms

LEGO and the LEGO logo are trademarks of the/son des marques de commerce du/son marcas registradas de LEGO Group. ©2023 The LEGO Group.

6447514