



# NINJAGO

71784





### **Get excited about our new packaging!**

We're switching from plastic to paper-based packaging. That's why you might find a mix of paper and plastic in our boxes!

### **Nos nouveaux emballages vous emballeront !**

Nous passons des emballages en plastique aux emballages à base de papier. C'est pourquoi vous pourriez trouver un mélange de papier et de plastique dans nos boîtes !

### **¡Te presentamos nuestros nuevos empaques!**

Estamos sustituyendo las bolsas de plástico por bolsas con base de papel. ¡Por eso, puedes encontrar una mezcla de papel y de plástico en nuestras cajas!

**[LEGO.com/sustainable-packaging](https://www.lego.com/sustainable-packaging)**

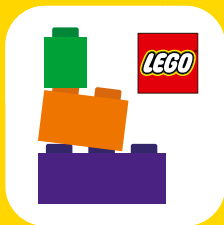

# BUILDER



Apple and the Apple logo are trademarks of Apple Inc., registered in the U.S. and other countries and regions. App Store is a service mark of Apple Inc. Google Play and the Google Play logo are trademarks of Google LLC. Tencent and the Tencent logo are trademarks of Tencent Inc.

 [LEGO.com/devicecheck](https://LEGO.com/devicecheck)

**EN** Ask parents' permission before going online | **DE** Eltern um Erlaubnis bitten, bevor du online gehst | **FR** Demande l'autorisation d'un parent avant d'aller en ligne | **IT** Chiedi il permesso ai tuoi genitori prima di andare online | **ES** Pídeles permiso a tus papás antes de conectarte a Internet | **PT** Pede autorização aos pais antes de acederes online | **JA** オンラインになる前に ほご者の方のきよかをもらおう | **ZH** 上网前应先征得父母的同意 | **KO** 온라인 접속 전에 보호자 동의를 필요합니다 | **RU** Спроси разрешения у родителей, прежде чем заходить в интернет | **PL** Poproś rodziców o zgodę, zanim wejdiesz do Internetu | **CS** Než půjdeš na internet, požádej rodiče o svolení | **SK** Skôr než pôjdeš na internet, vypýtaj si povolenie od rodičov | **HU** Kérj szülői engedélyt, mielőtt online csatlakoznál! | **RO** Cere permisiunea părinților înainte de a te conecta online | **BG** Поискайте разрешение от родител, преди да влезете онлайн | **LV** Pirms došanās tiešsaistē palūdz atļauju vecākiem | **ET** Enne Interneti kasutamist küsi vanematelt luba | **LT** Prieš prisijungdami prie interneto, atsiklauskite tėvų

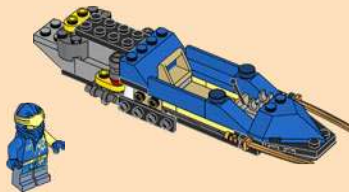

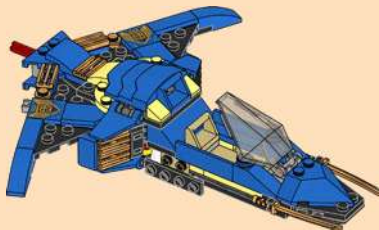

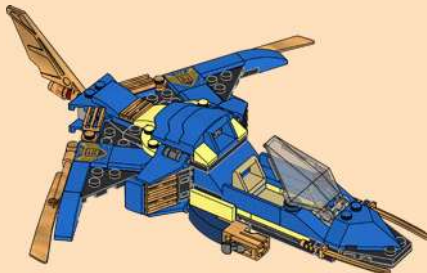

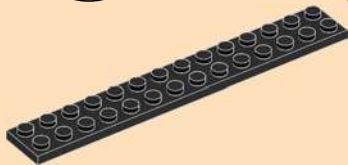
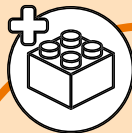

1x



1

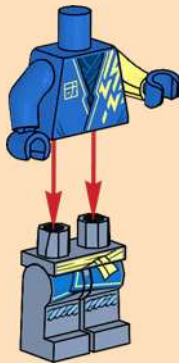

2

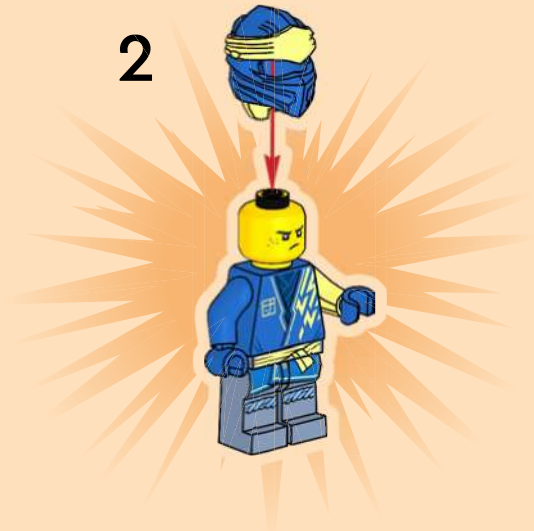







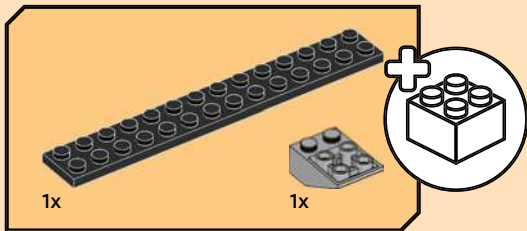

1

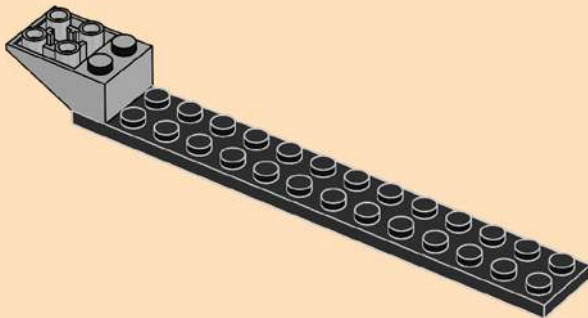

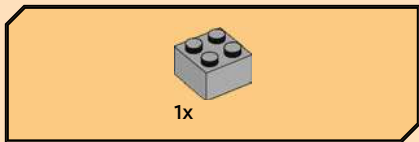

2

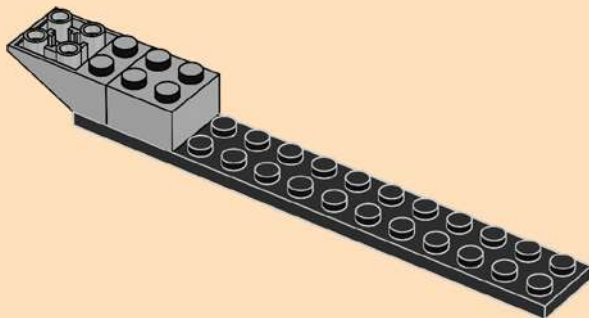

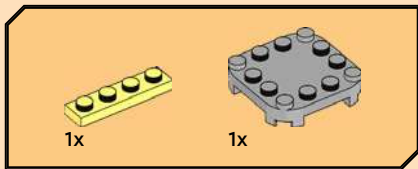

3

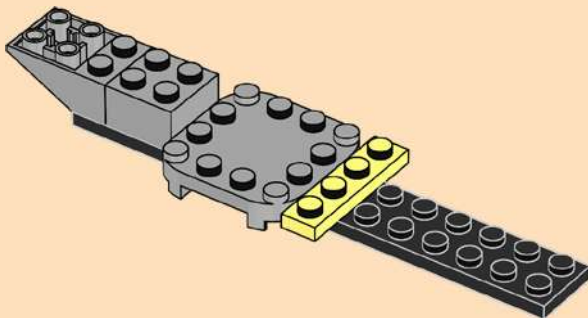



4

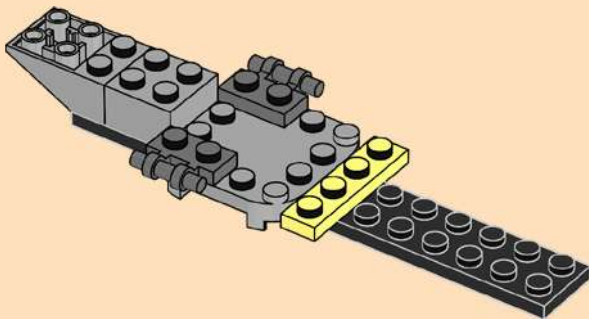

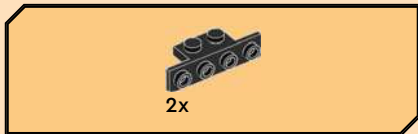

5

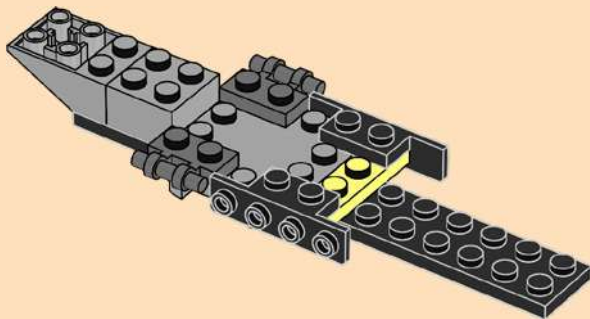



6

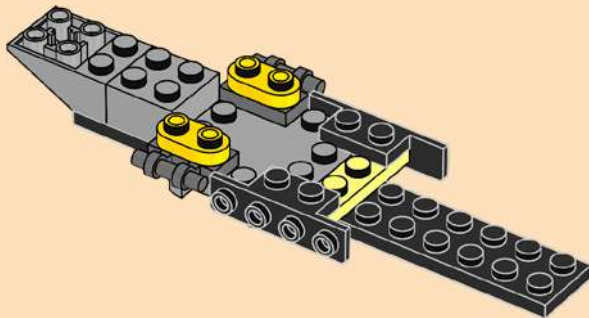





7

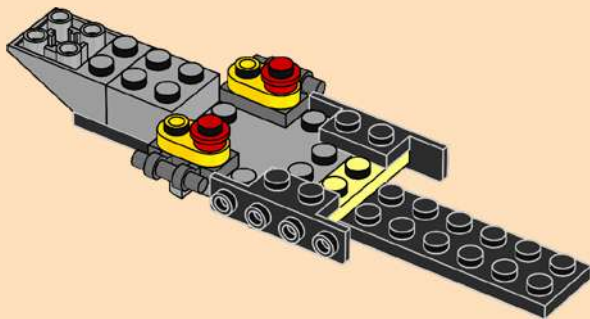



2x

8

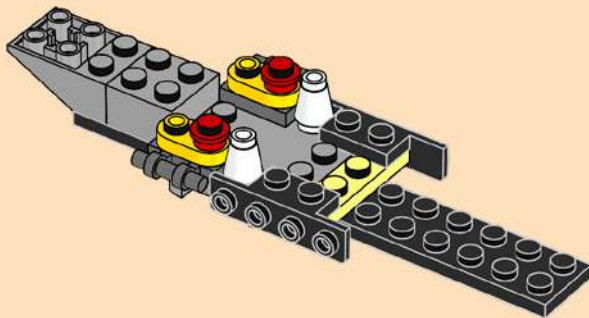

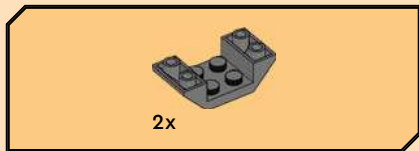

9

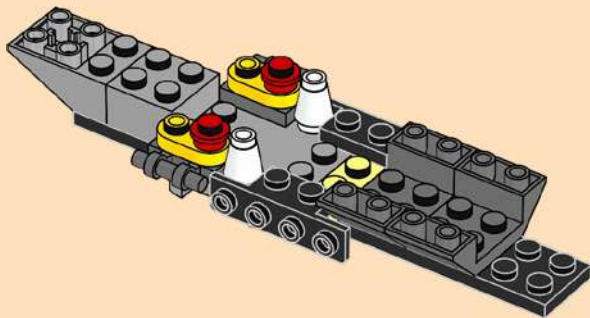

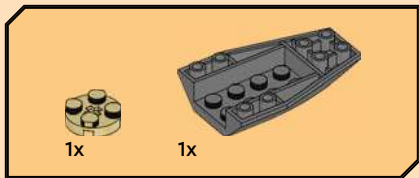

10

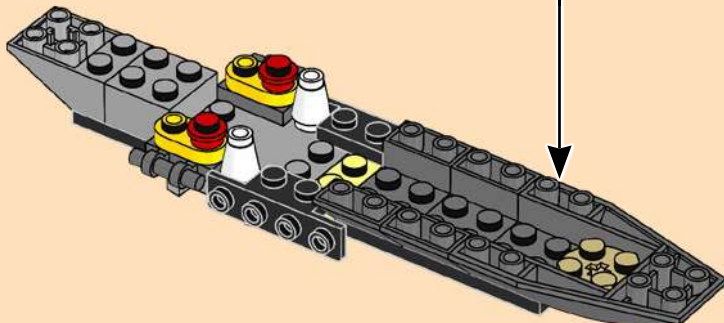
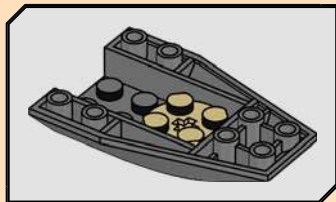

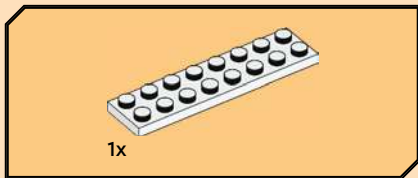

11

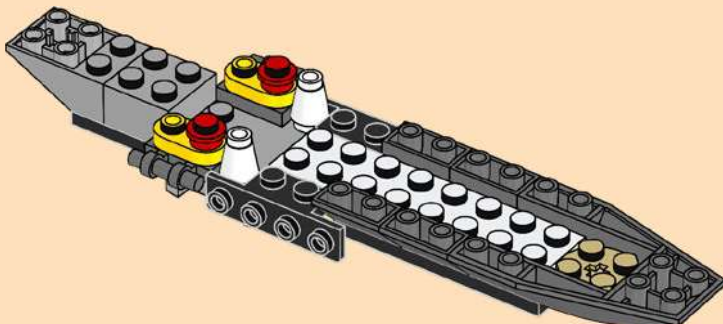



2x

12

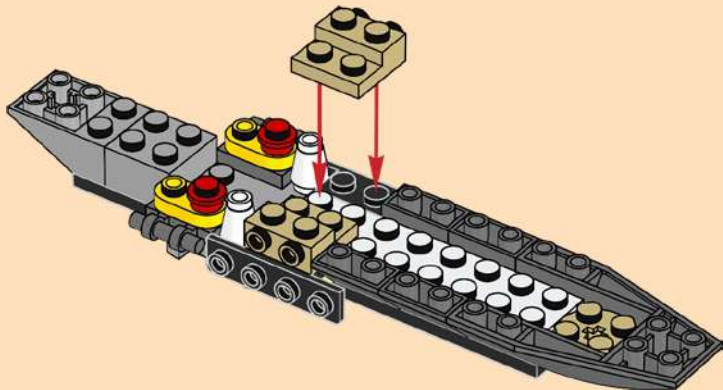

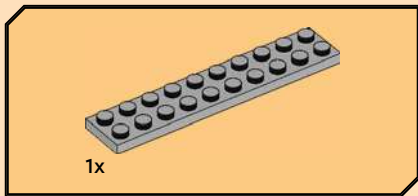

13

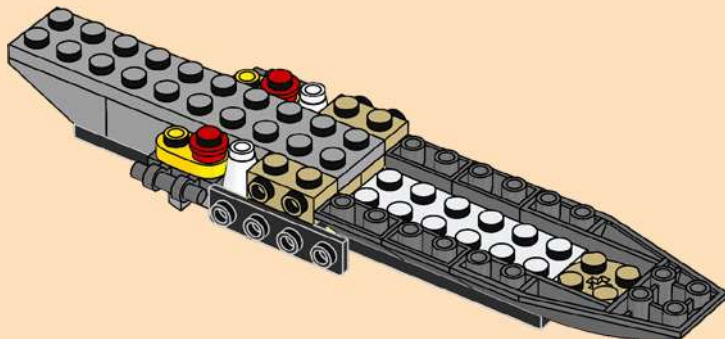

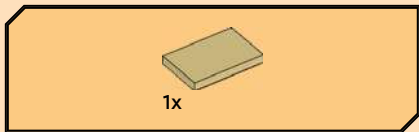

14

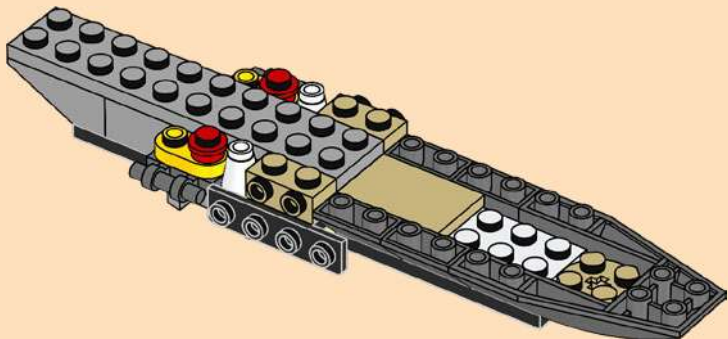

24



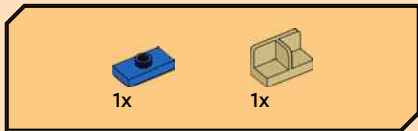

15

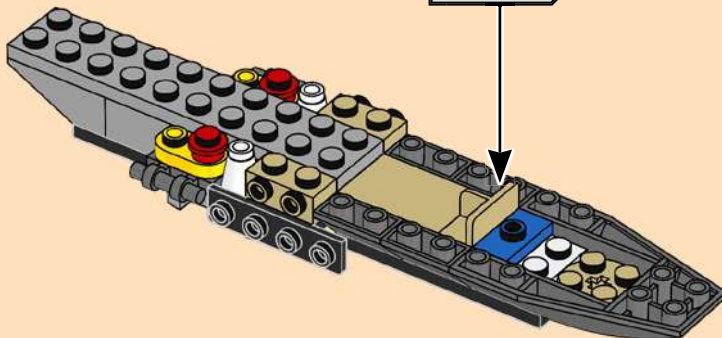
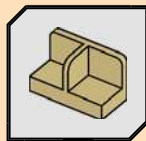

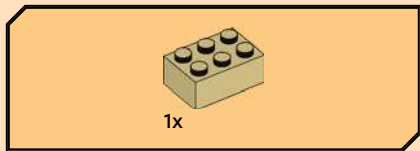

16

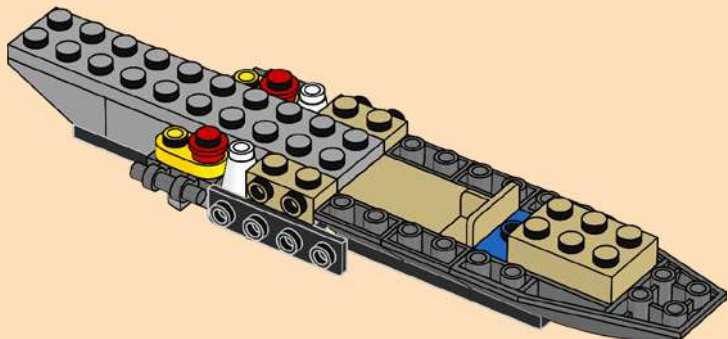

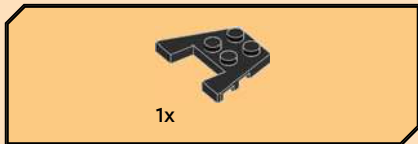

17

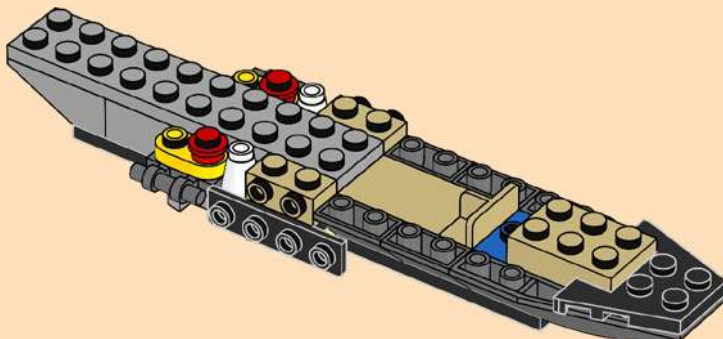



2x

18

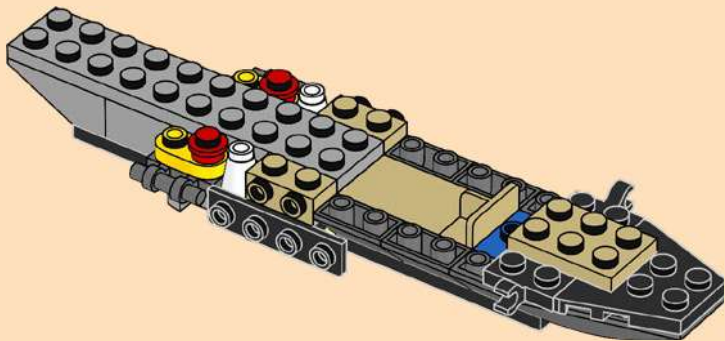

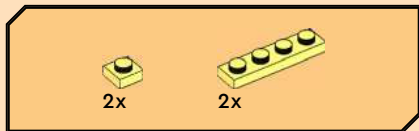

19

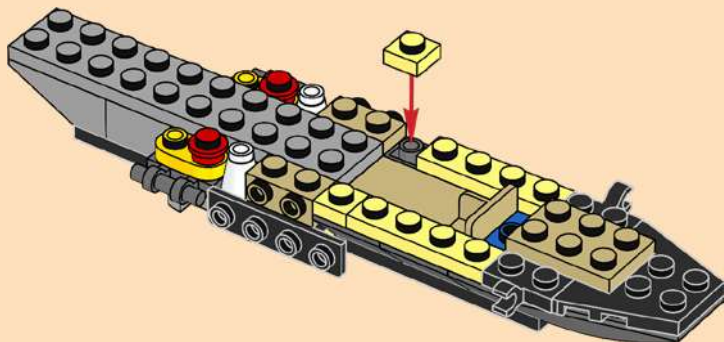



2x

20

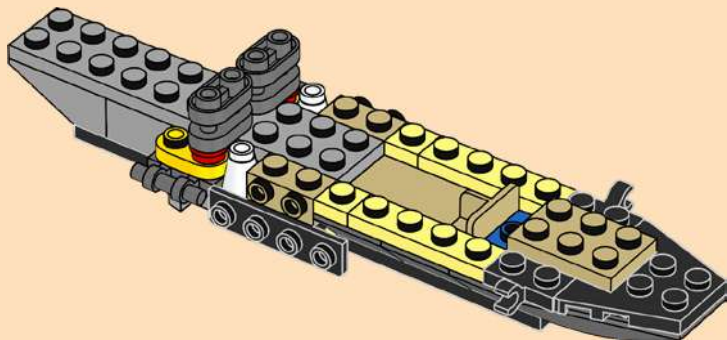

30



21

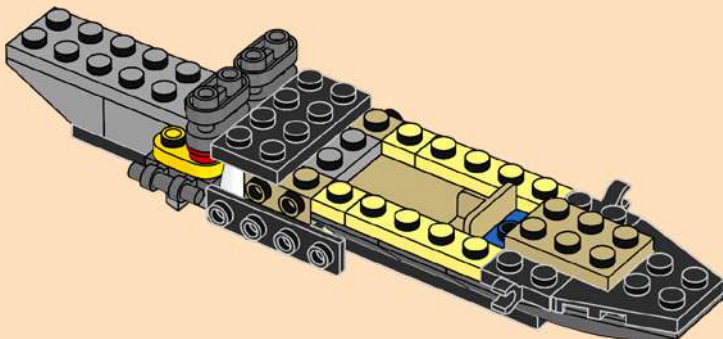

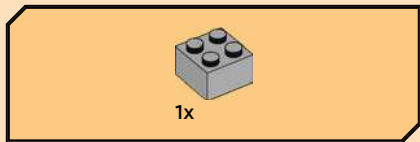

22

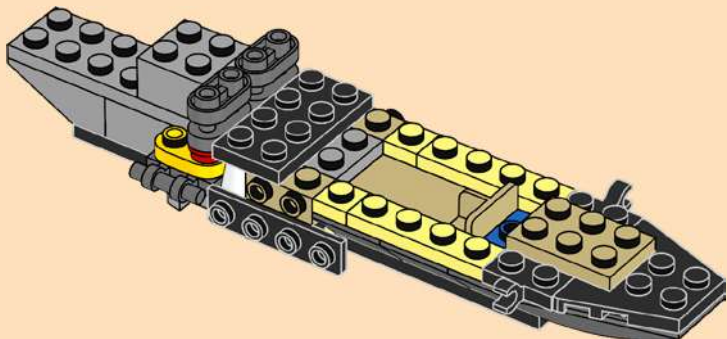





2x

23

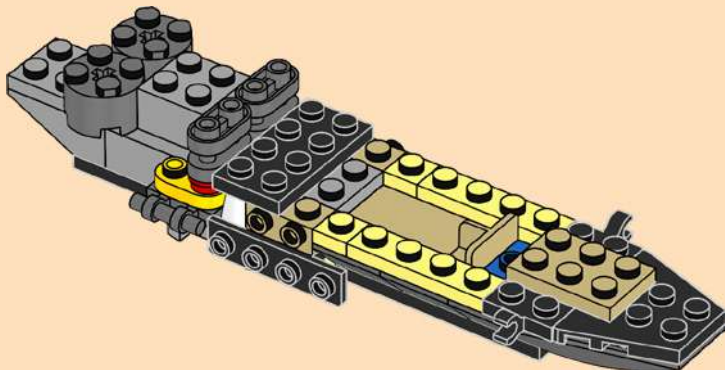



1x

24

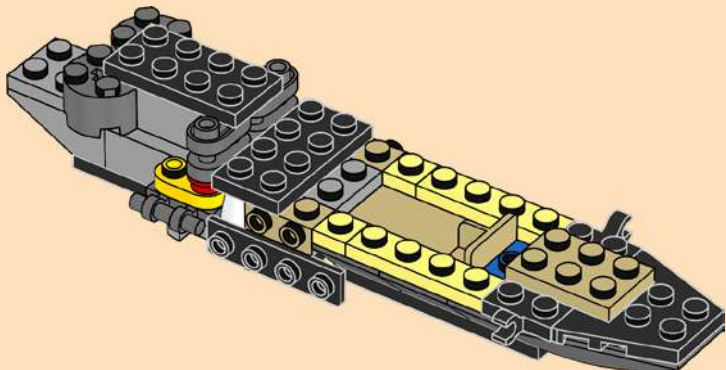

34



25

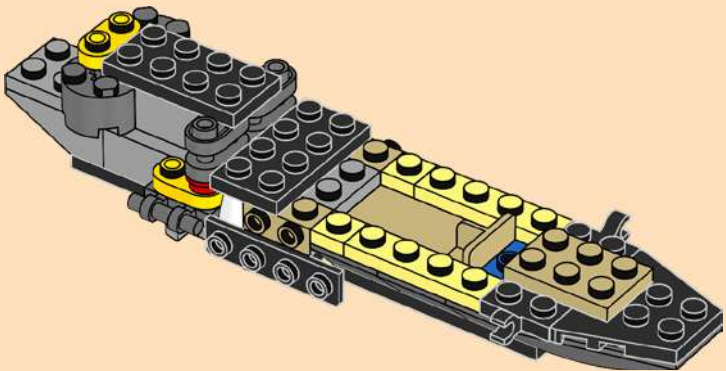

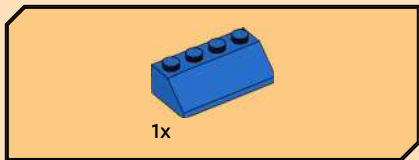

26

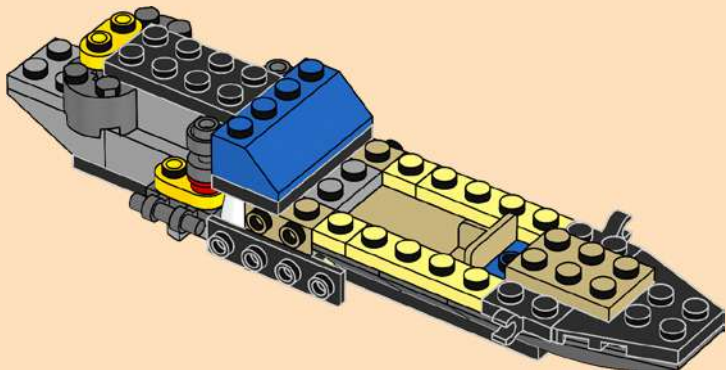



1x

27

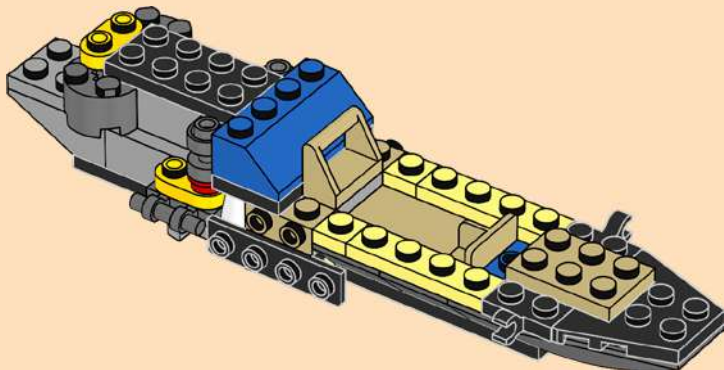

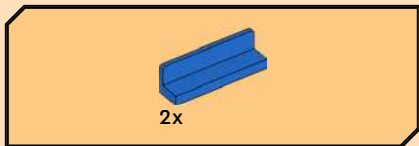

28

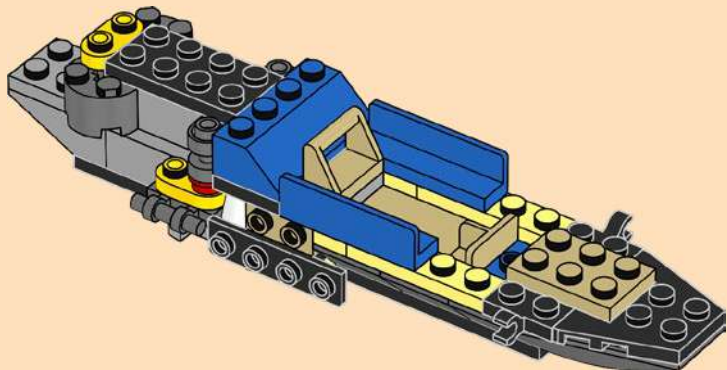

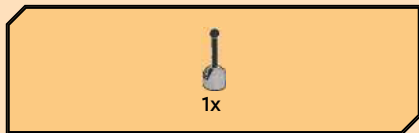

29

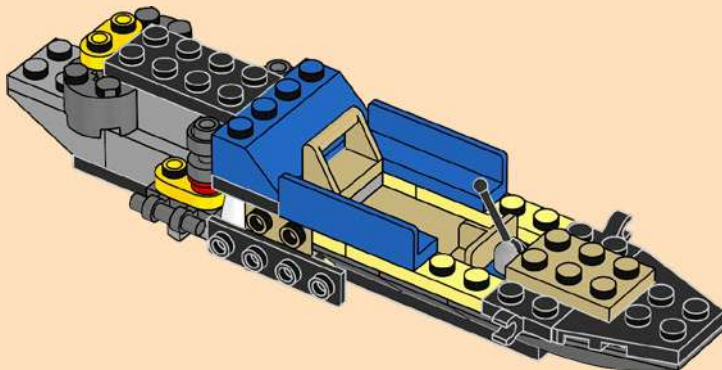



2x

30

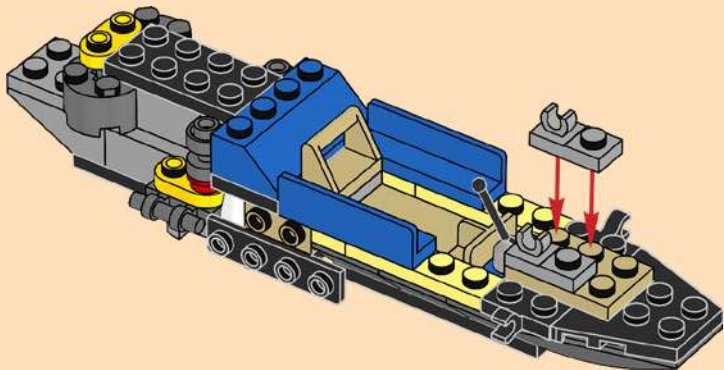

40



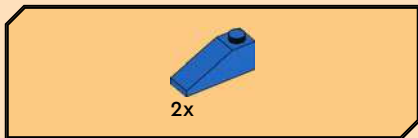

31

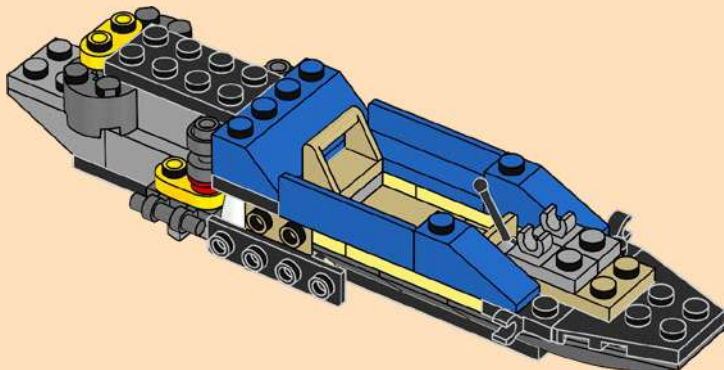



2x

32

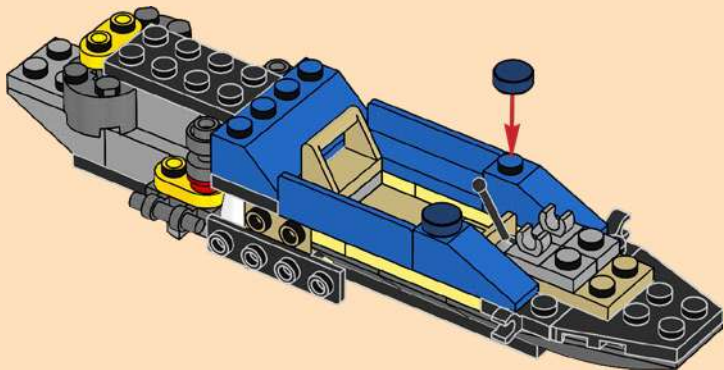

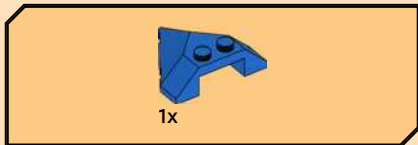

33

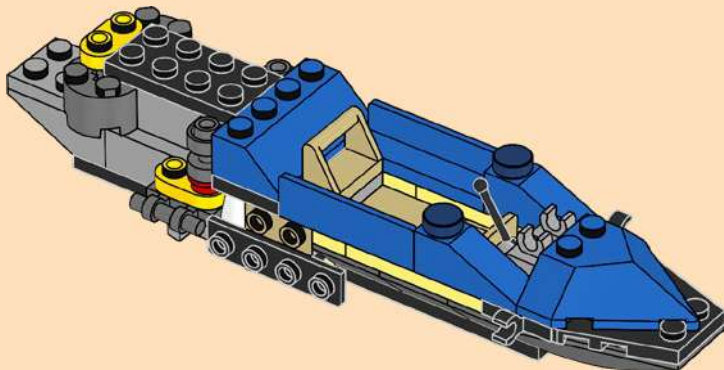



34

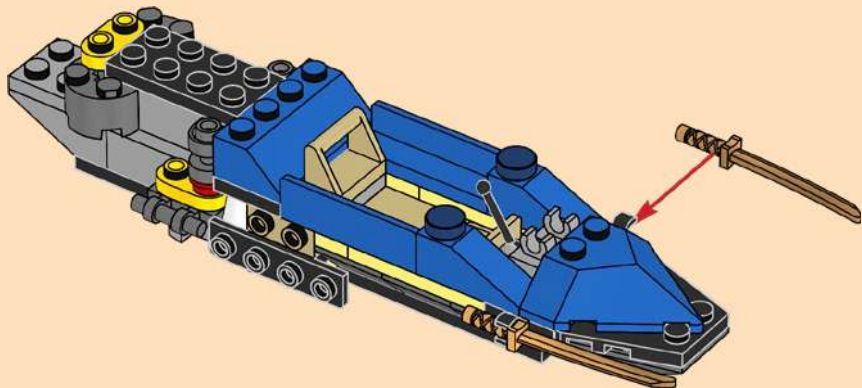

44



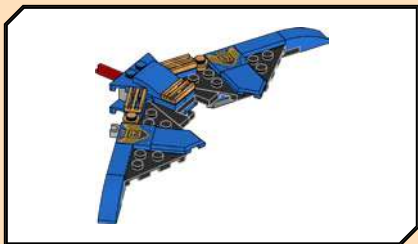

1x



1x

# 35



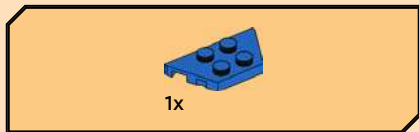

36





1x

37



48



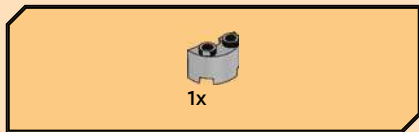

38



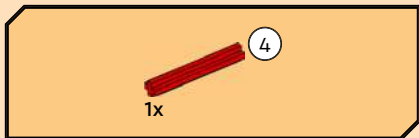

39

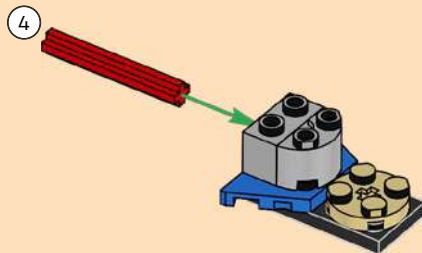

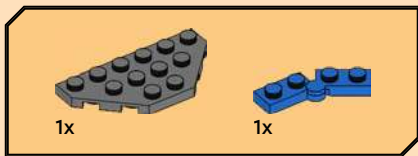

40

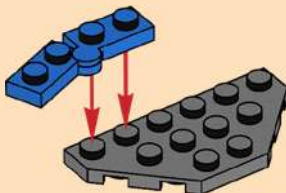



1x



1x

# 41

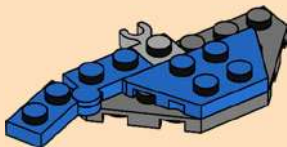

52

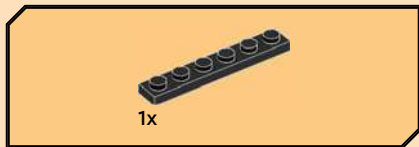

42

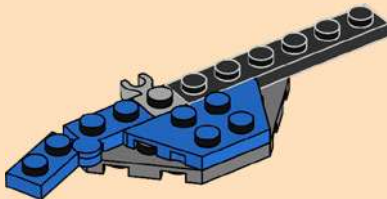



43

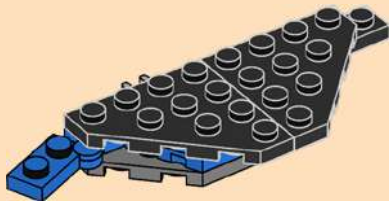

54



1x

44



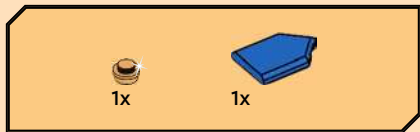

45





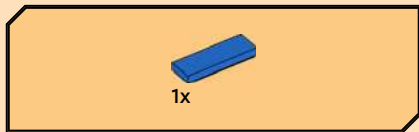

46



47

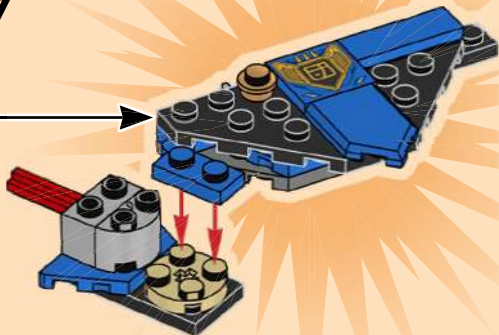



48





1x



1x

# 49

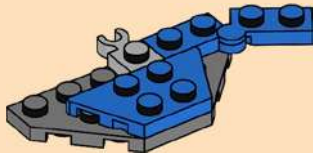

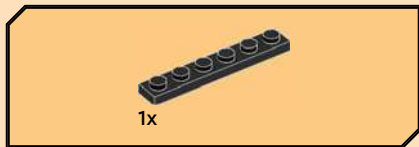

50

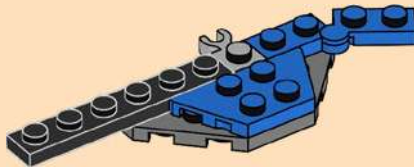



51



62



1x

52





53



64



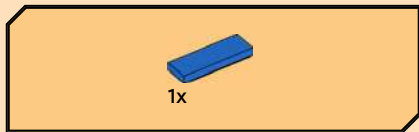

54



55

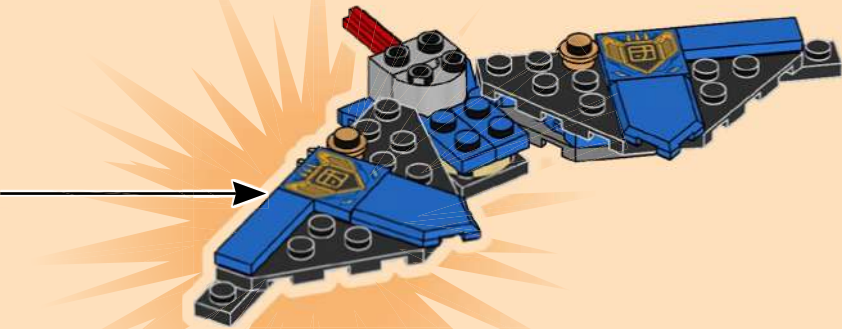

66

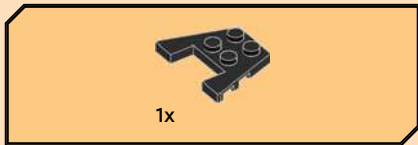

56

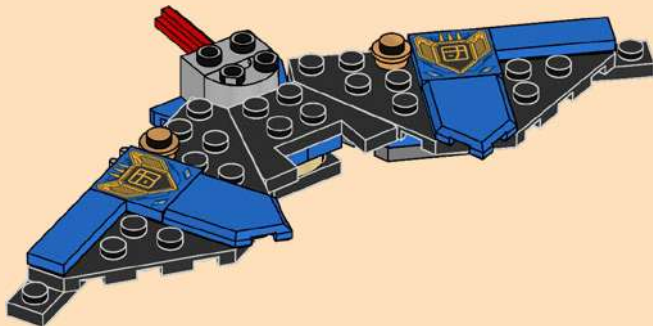

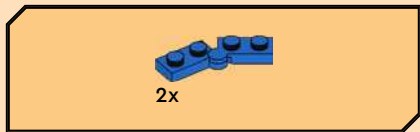

57

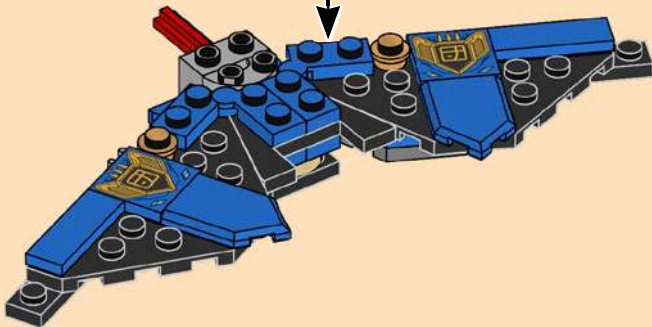
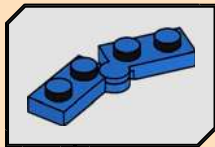



2x

58

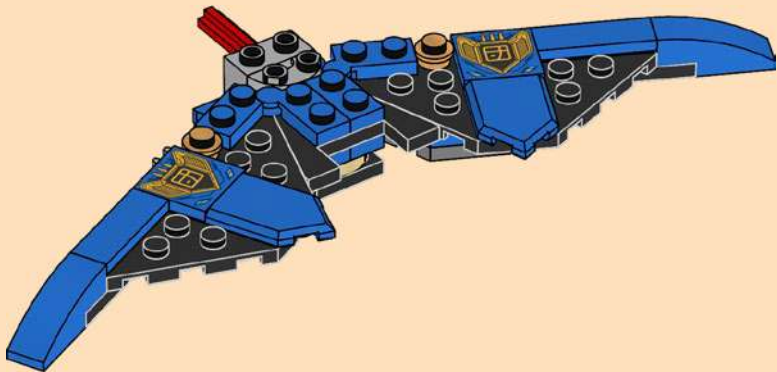



1x

59

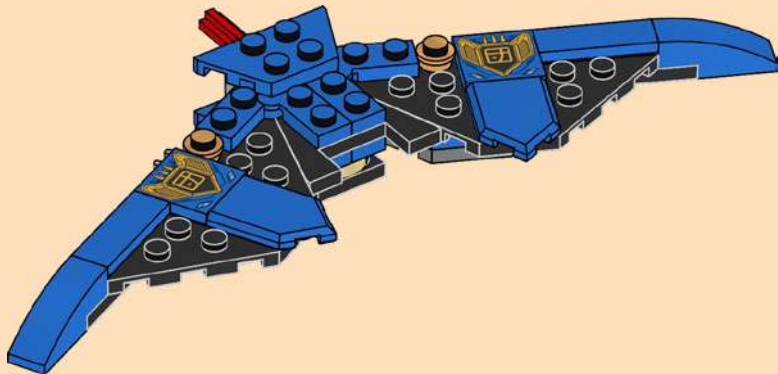

70

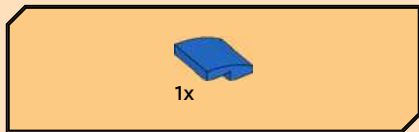

60

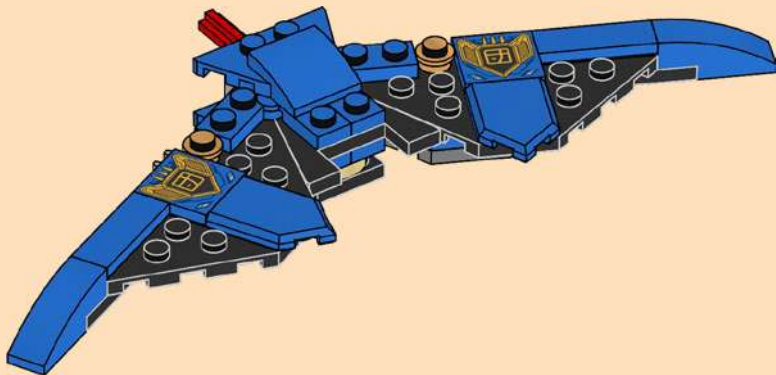

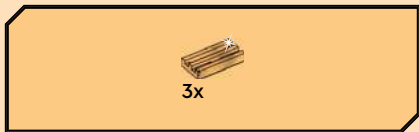

61

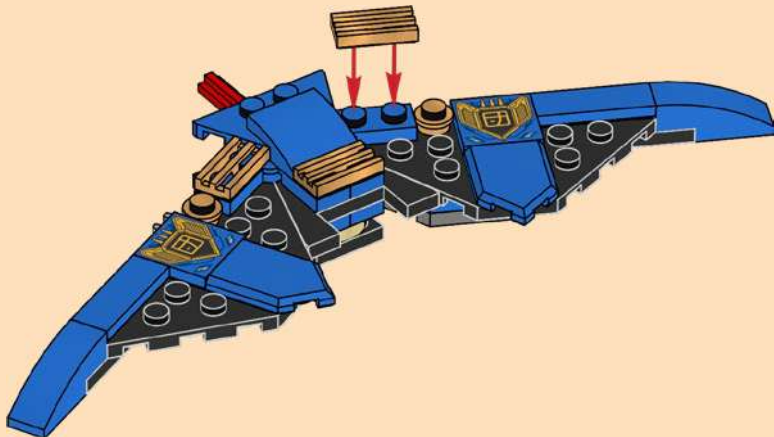



62



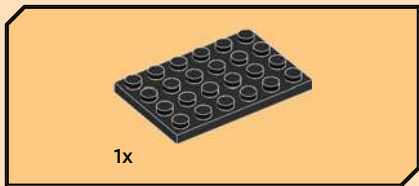

63

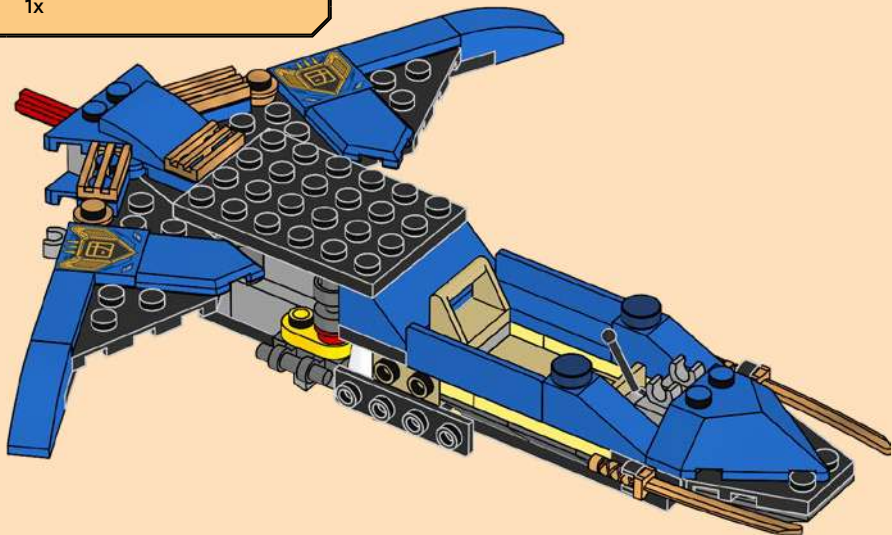



2x



2x

64



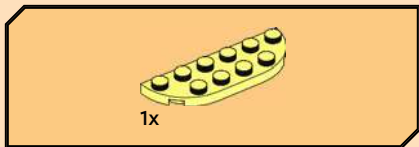

65

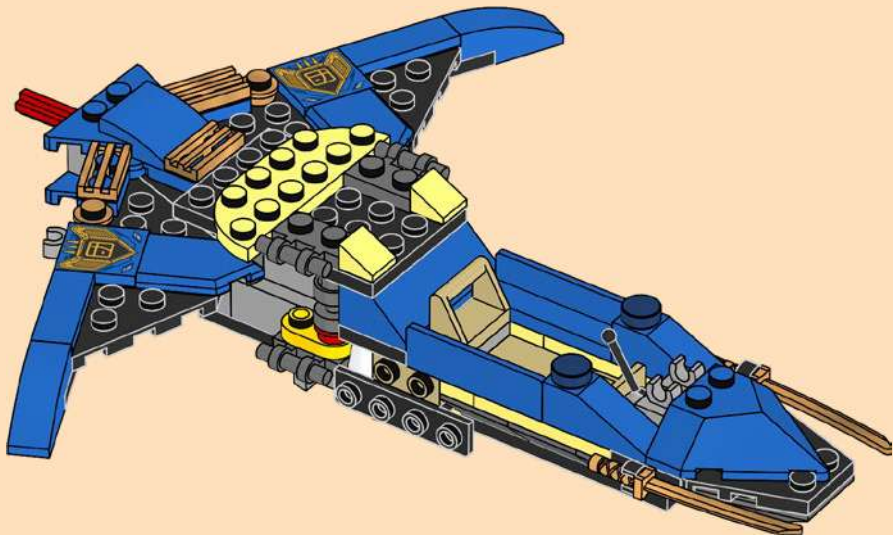

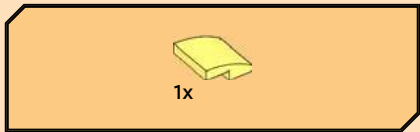

66



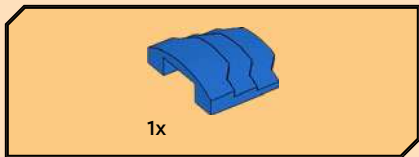

67



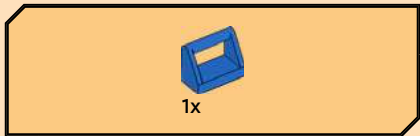

68

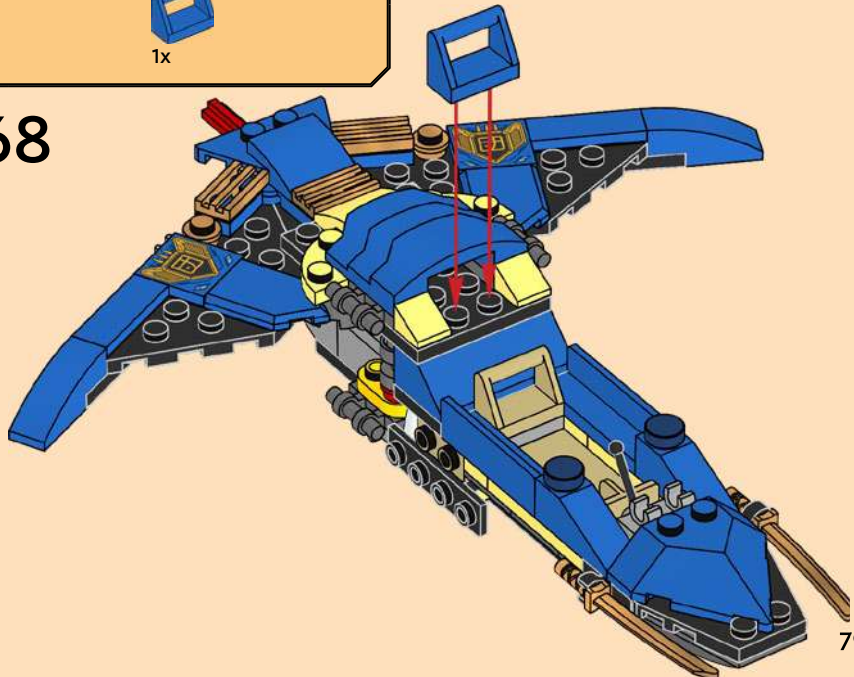

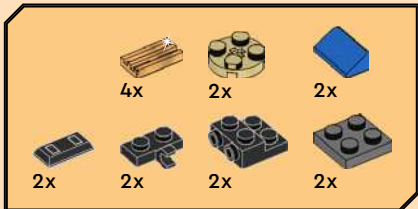

69

1



2



3



4





5



6

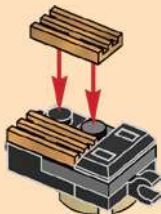

7

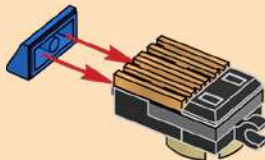

2x

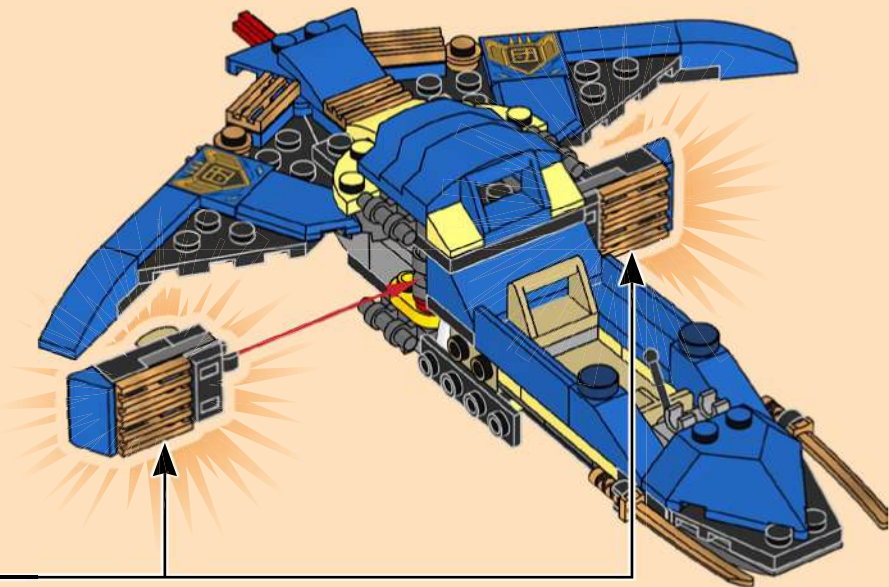

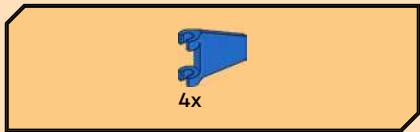

70

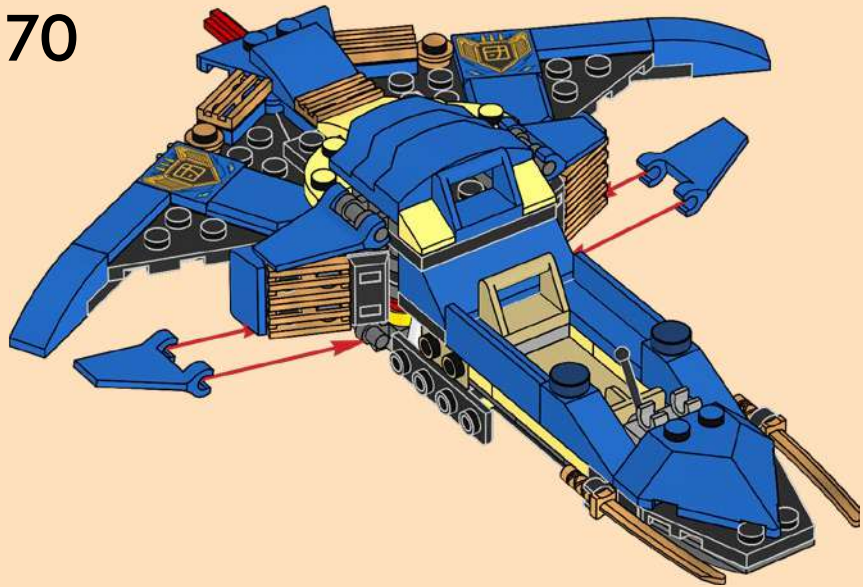

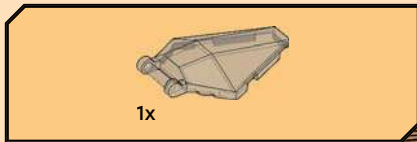

71

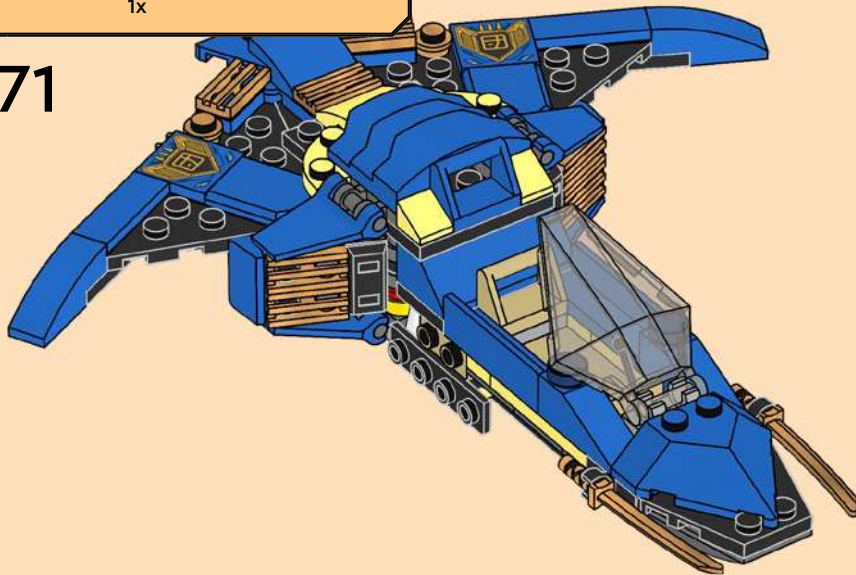

84

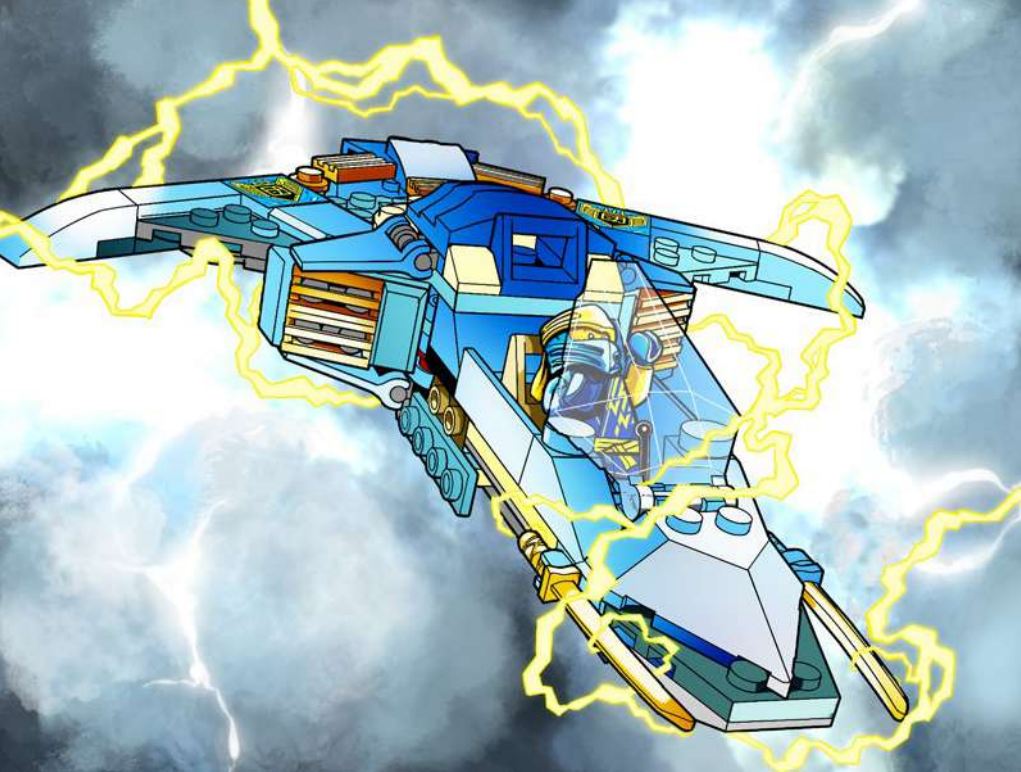



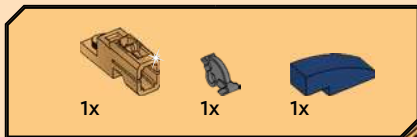

72

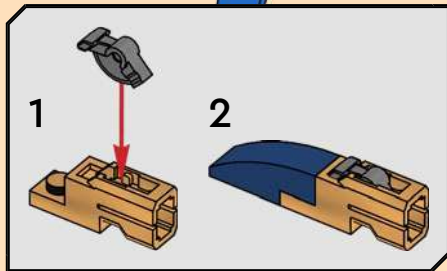
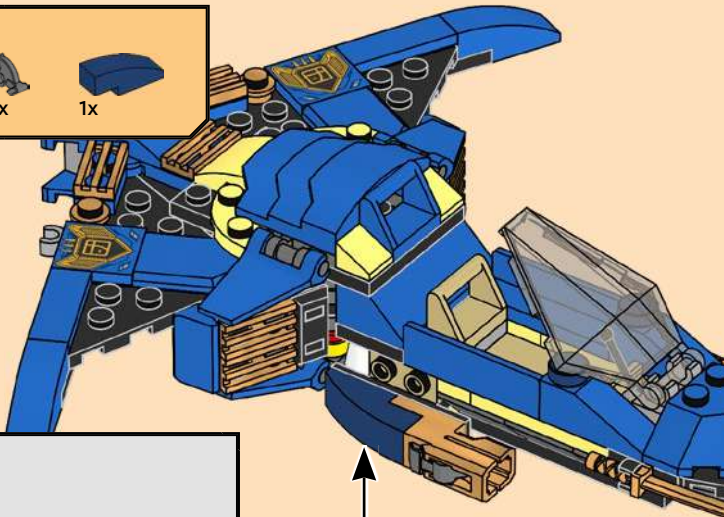

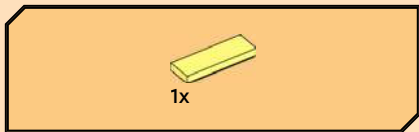

73

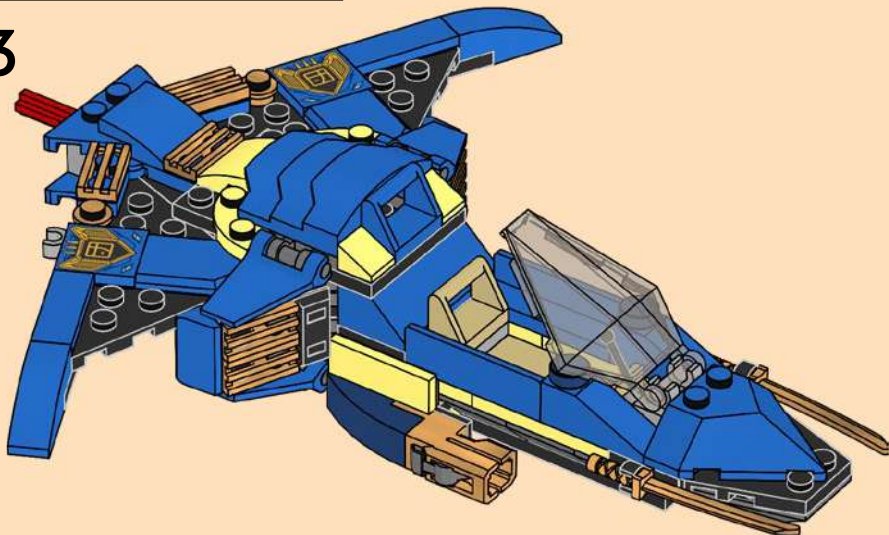



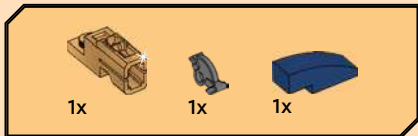

74

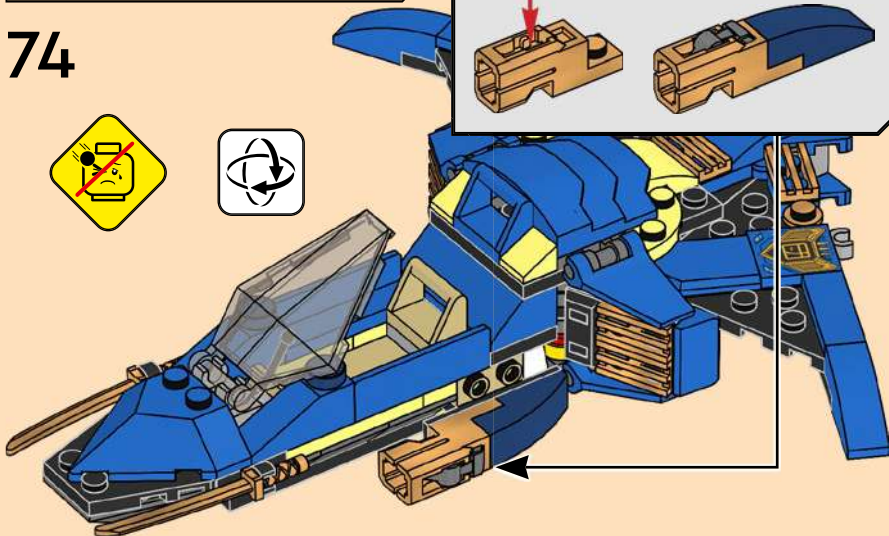
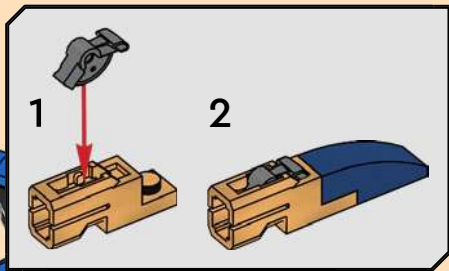

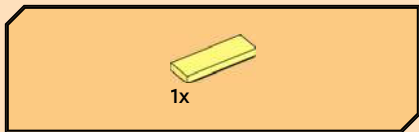

75

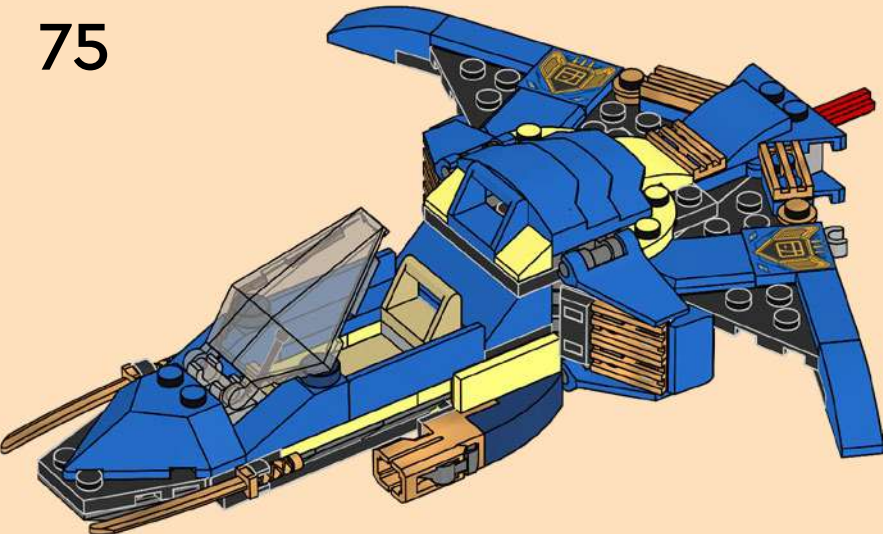

90

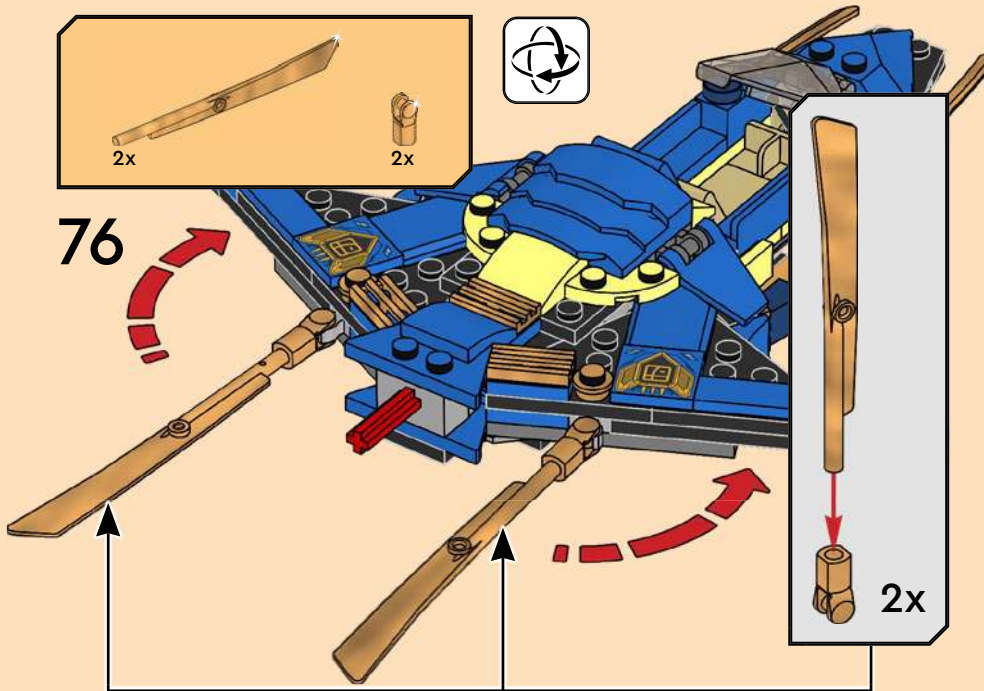

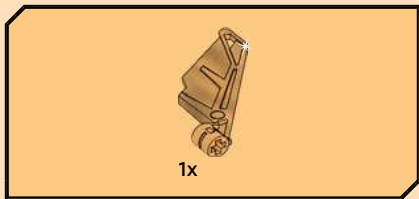

77

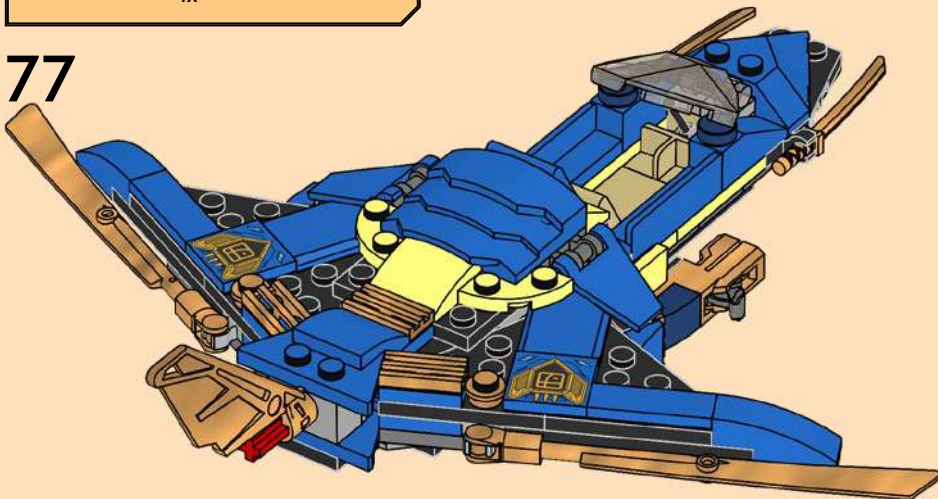



1x

78

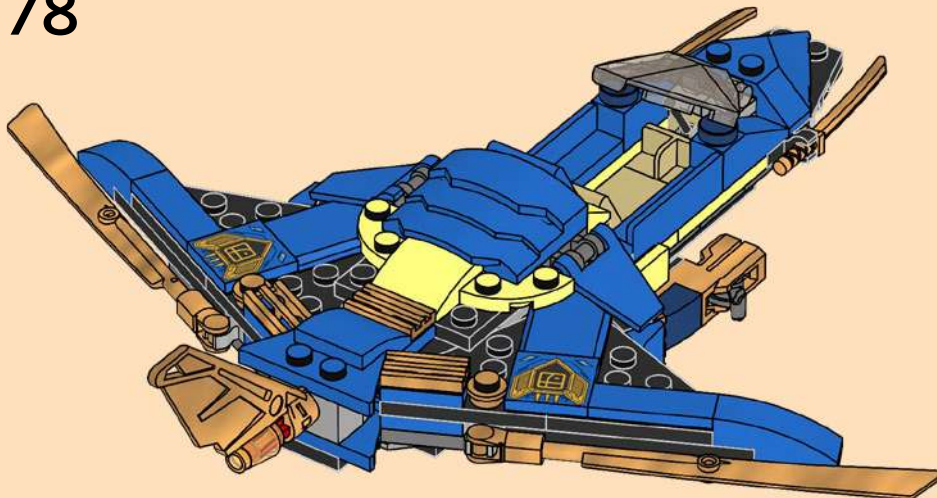

4x

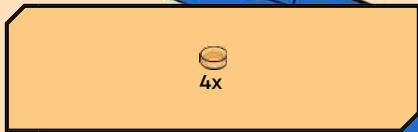

79

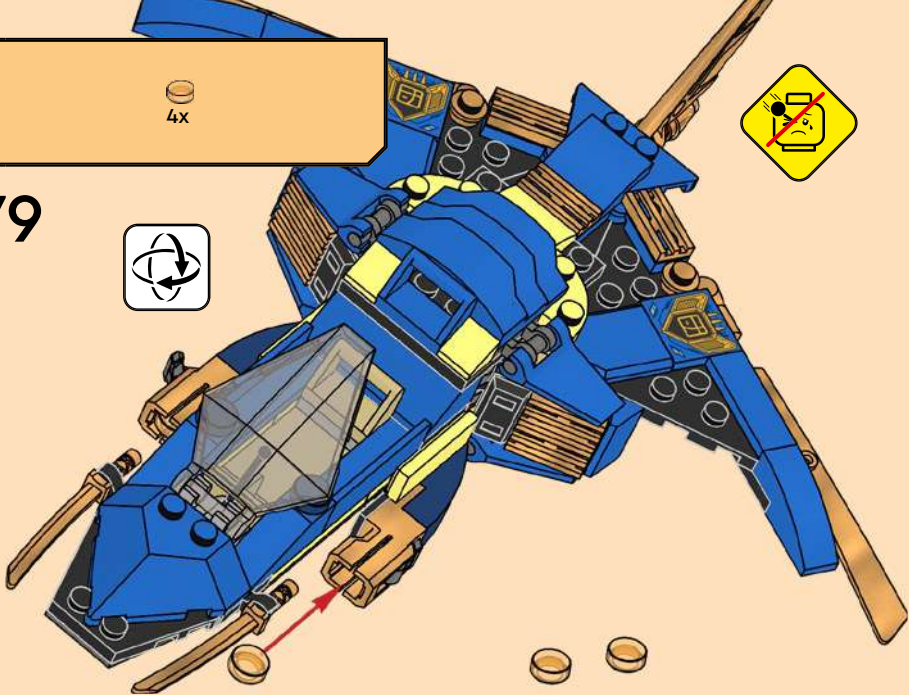



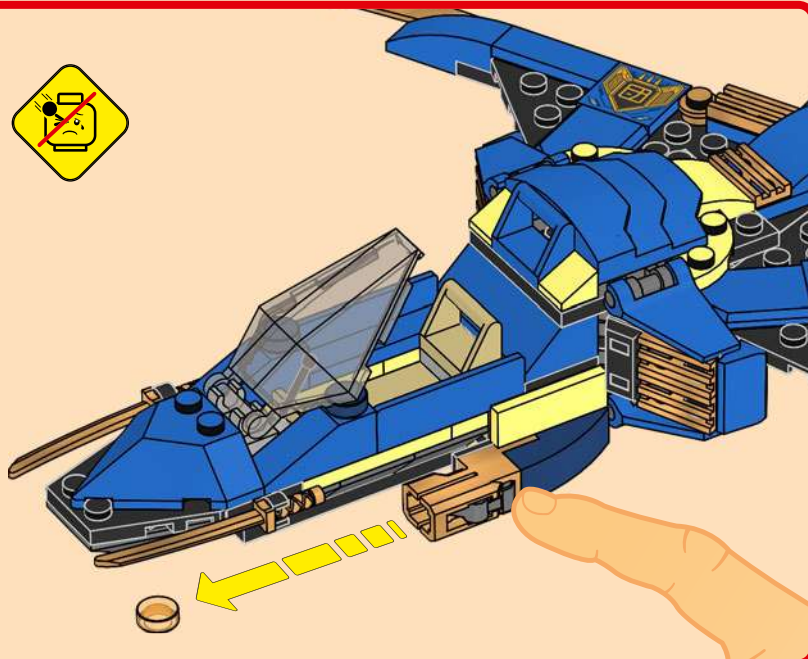



**LEGO**

# NINJAGO



**71785**



**71786**



**71787**



**71781**



**71782**



**71780**



**71784**



**71783**



4x  
4140562



1x  
6021208



1x  
6153157



2x  
6132769



1x  
4159739



1x  
6175367



2x  
614121



1x  
6129995

**98**



1x  
6371747



2x  
4651236



1x  
243223



1x  
6092582



4x  
6424609



1x  
6116786



2x  
6421055



1x  
6371741



2x  
428623



2x  
4587840



2x  
4543998



2x  
6245248



4x  
4609454



2x  
6146957



1x  
6424606



4x  
6416505



1x  
4107437



1x  
6421594



1x  
6172233



4x  
6274747



1x  
6341749



2x  
6284584



2x  
4540280



2x  
6360675



2x  
6390673



2x  
4249139



4x  
4210660



2x  
4211094



2x  
4211076



2x  
4210984



1x  
4636417



1x  
4221775



1x  
6311384



2x  
6296894



2x  
6326078



1x  
6206249



2x  
4211387



1x  
6435930

4



1x  
6294703



1x  
4211462



2x  
4518400



1x  
303401



2x  
366626



1x  
6001494



1x  
303226



4x  
6313116



2x  
6156991



2x  
6052126



2x  
6168620



4x  
4160025



2x  
6170529



3x  
302026



1x  
6377827



2x  
6058014



1x  
6296487



2x  
6195265



3x  
6248756



1x  
6147709



2x  
6296498



1x  
6191858



3x  
6248971



2x  
6296657



2x  
4523159



2x  
6345949



2x  
6116596



1x  
6213766



2x  
6270131



7x  
4490599



LEGO.com/service

YOU COULD

WIN



Scan this QR code or go to  
**LEGO.COM/PRODUCTFEEDBACK** and give us  
your short feedback about this LEGO® set  
for a chance to win a cool LEGO prize.

Terms and Conditions apply\*

**DE: Du könntest GEWINNEN.** Es gelten die Teilnahmebedingungen\* **FR: Tu pourrais GAGNER.** Des conditions s'appliquent\* **IT: Potresti VINCERE tu.** Termini e condizioni sono applicabili\* **ES: Puedes GANAR.** Aplican términos y condiciones\* **PT: Poderá GANHAR.** Aplicam-se termos e condições\* **JA: プレゼント付き! 利用規約が適用されます\*** **ZH: 轻松获奖. 条款和条件适用\*** **KO: 상품의 주인이 되어보세요. 소정의 약관이 적용됩니다\*** **RU: Вы можете ВЫИГРАТЬ.** Действуют положения и условия\* **PL: Szansa na WYGRANĄ.** Obowiązują warunki korzystania\* **CS: Máte šanci VYHRÁT.** Platí všeobecné smluvní podmínky\* **SK: Máte šancu VYHRATĚ.** Platia všeobecné zmluvné podmienky\* **HU: TE IS NYERHETSZ.** Felhasználási feltételek érvényesek\* **RO: Ai putea CĂȘTIGA.** Se aplică termenii și condiții\* **BG: Можете да СПЕЧЕЛИТЕ.** Има определени правила и условия\* **LV: Tu vari LAIMĒT.** Ir spēkā noteikumi un nosacījumi.\* **ET: Sul on võimalus VÕITA.** Kehtivad tingimused\* **LT: Jūs galite LAIMĖTI.** Taikomos sąlygos\*

\*[LEGO.com/productfeedback-terms](https://www.lego.com/productfeedback-terms)

LEGO, the LEGO logo, NINJAGO and the NINJAGO logo are trademarks of the/son des marques de commerce du/son marcas registradas de LEGO Group. ©2023 The LEGO Group.

6449668