



CITY

60390



**WARNING: CHOKING HAZARD.**  
Small parts. Not for children under 3 years.



### **Get excited about our new packaging!**

We're switching from plastic to paper-based packaging. That's why you might find a mix of paper and plastic in our boxes!

### **Nos nouveaux emballages vous emballeront !**

Nous passons des emballages en plastique aux emballages à base de papier. C'est pourquoi vous pourriez trouver un mélange de papier et de plastique dans nos boîtes !

### **¡Te presentamos nuestros nuevos empaques!**

Estamos sustituyendo las bolsas de plástico por bolsas con base de papel. ¡Por eso, puedes encontrar una mezcla de papel y de plástico en nuestras cajas!

**[LEGO.com/sustainable-packaging](https://www.lego.com/sustainable-packaging)**

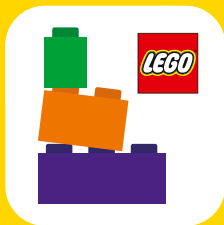

# BUILDER



Apple and the Apple logo are trademarks of Apple Inc., registered in the U.S. and other countries and regions. App Store is a service mark of Apple Inc. Google Play and the Google Play logo are trademarks of Google LLC. Tencent and the Tencent logo are trademarks of Tencent Inc.

 [LEGO.com/devicecheck](https://www.lego.com/devicecheck)

**EN** Ask parents' permission before going online | **DE** Eltern um Erlaubnis bitten, bevor du online gehst | **FR** Demande l'autorisation d'un parent avant d'aller en ligne | **IT** Chiedi il permesso ai tuoi genitori prima di andare online | **ES** Pídeles permiso a tus papás antes de conectarte a Internet | **PT** Pedir autorização aos pais antes de acederes online | **JA** オンラインになる前に ほご者の方のきよかをもらおう | **ZH** 上网前应先征得父母的同意 | **KO** 온라인 접속 전에 보호자 동의가 필요합니다 | **RU** Спроси разрешения у родителей, прежде чем заходить в интернет | **PL** Poproś rodziców o zgodę, zanim wejdiesz do Internetu | **CS** Než půjdeš na internet, požádej rodiče o svolení | **SK** Skôr než pôjdeš na internet, vypýtaj si povolenie od rodičov | **HU** Kérj szülői engedélyt, mielőtt online csatlakoznál! | **RO** Cere permisiunea părinților înainte de a te conecta online | **BG** Поискайте разрешение от родители, преди да влезете онлайн | **LV** Pirms došanās tiešsaistē palūdz atļauju vecākiem | **ET** Enne Interneti kasutamist küsi vanematelt luba | **LT** Prieš prisijungdami prie interneto, atsiklauskite tėvų





**AVERTISSEMENT :  
RISQUE D'ÉTOUFFEMENT.**

Contient des petites pièces.  
Ne convient pas aux  
enfants de moins de 3 ans.



**ADVERTENCIA:  
PELIGRO DE ASFIXIA.**

No recomendado para niños  
menores de 3 años.  
Contiene piezas pequeñas.



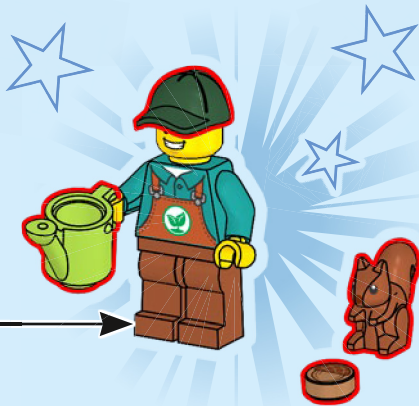
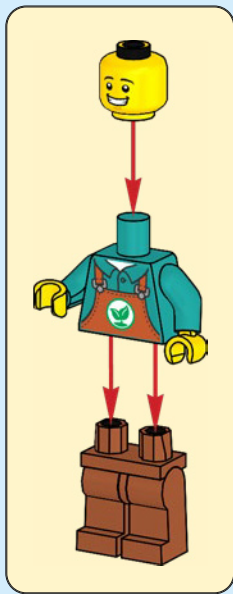

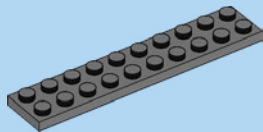

1

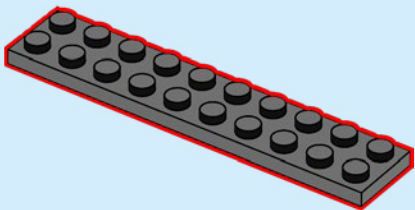

6



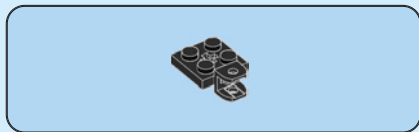

2

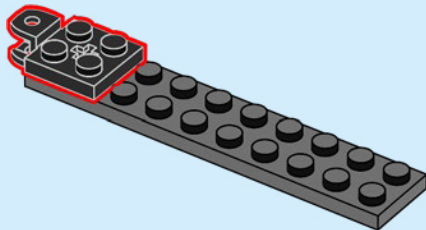

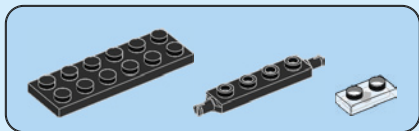

3

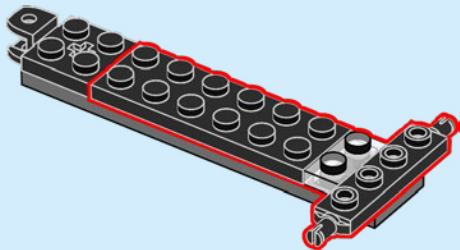



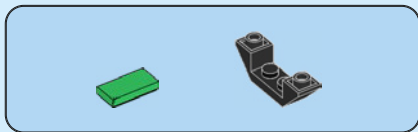

4

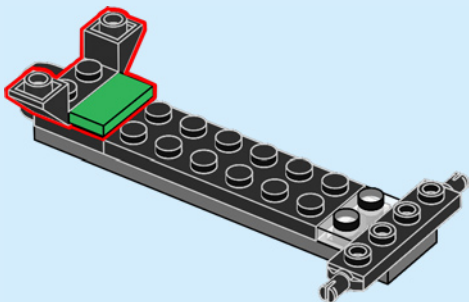

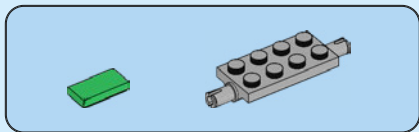

5

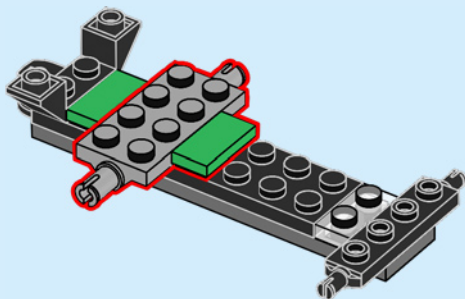

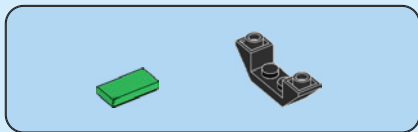

6

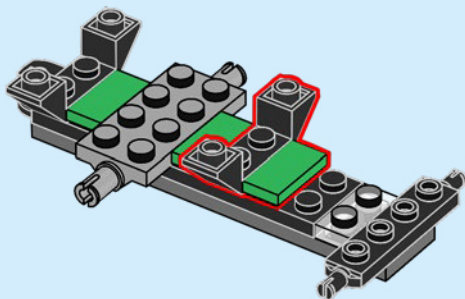

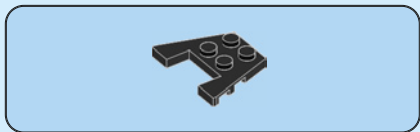

7

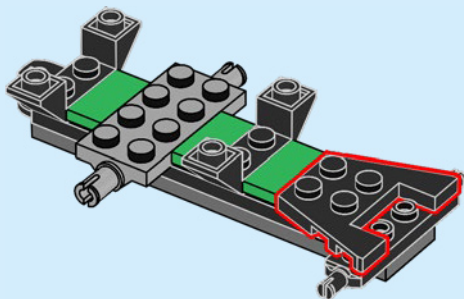

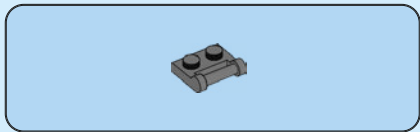

8

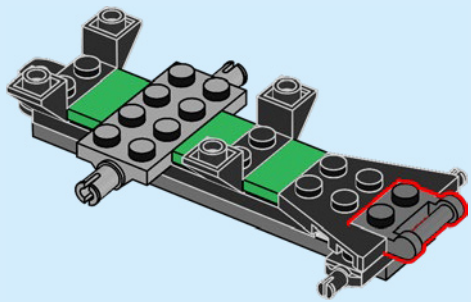

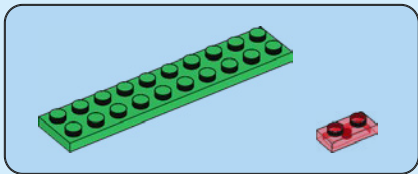

9

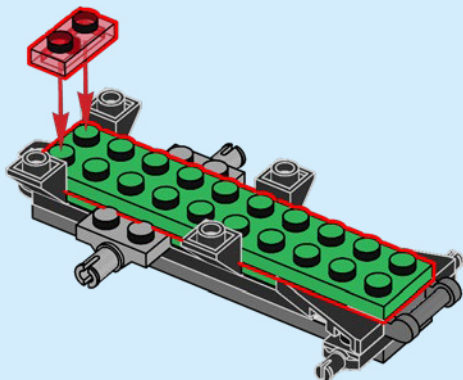

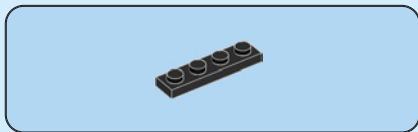

10

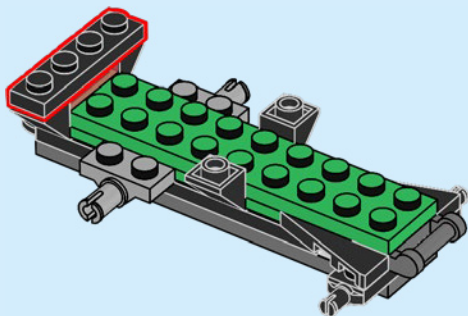

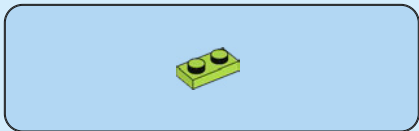

11

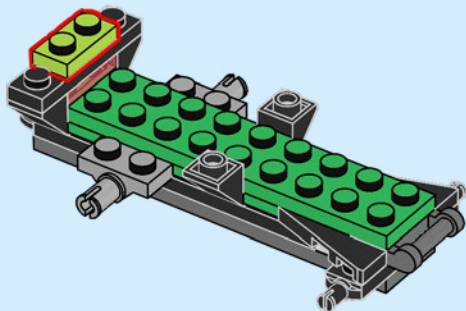



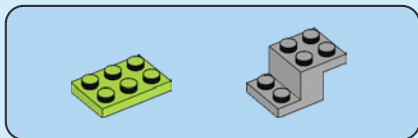

12

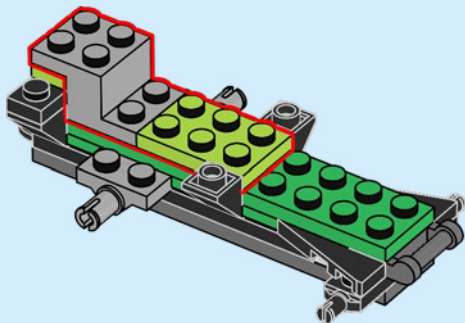

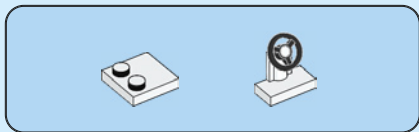

13

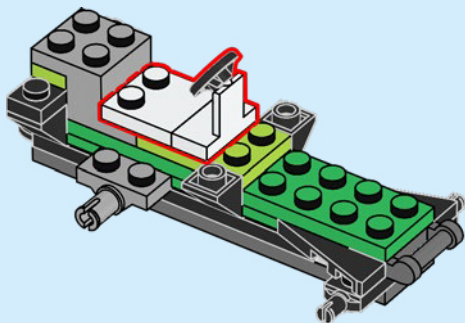

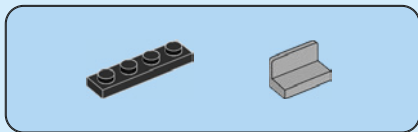

14

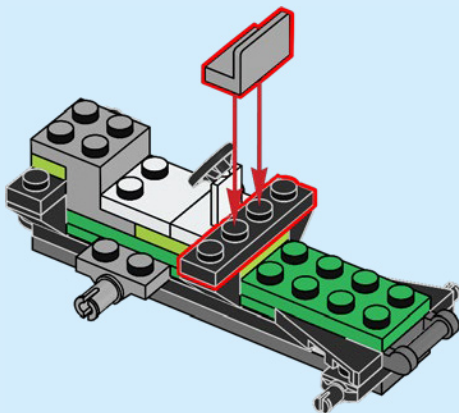



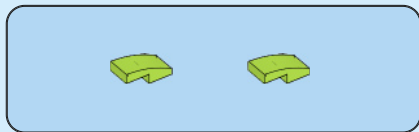

16

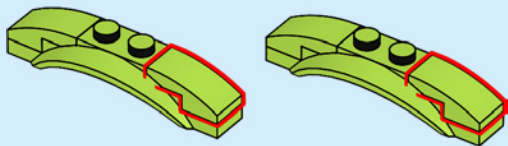

17

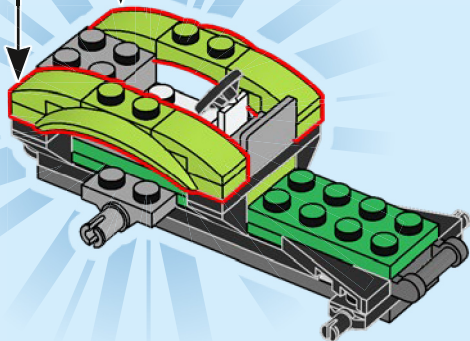

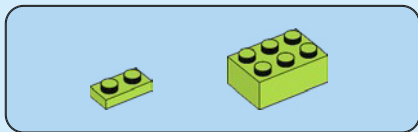

18

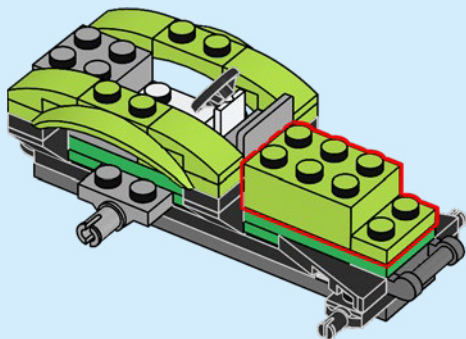



19

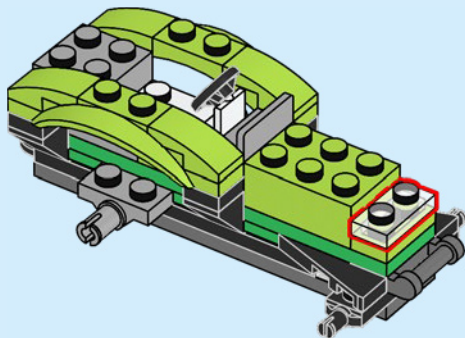



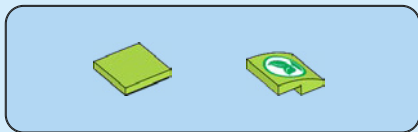

20

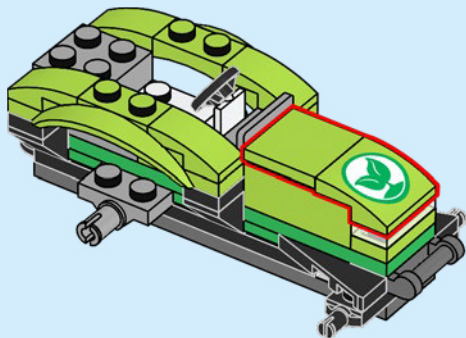



21

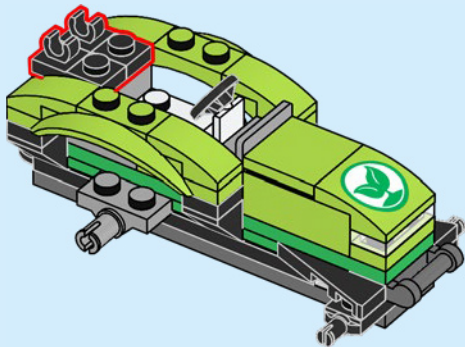

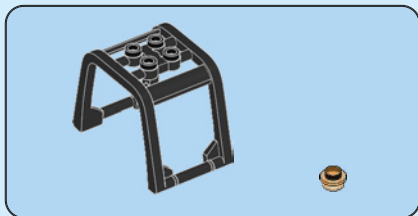

22

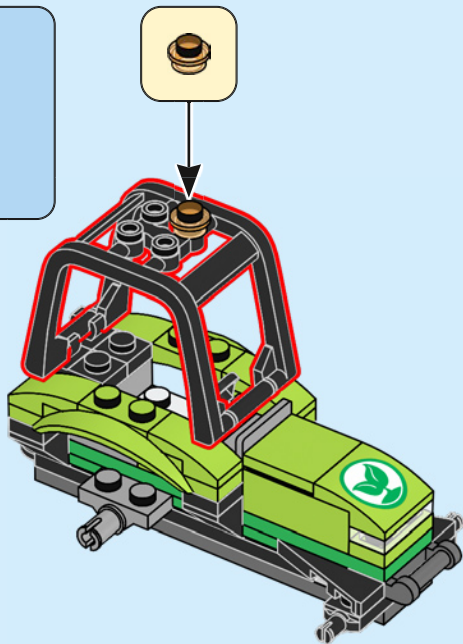

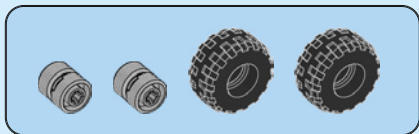

23

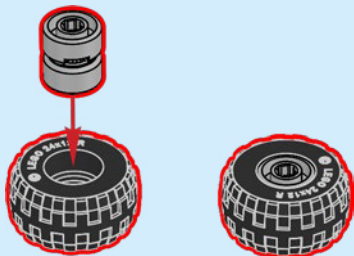

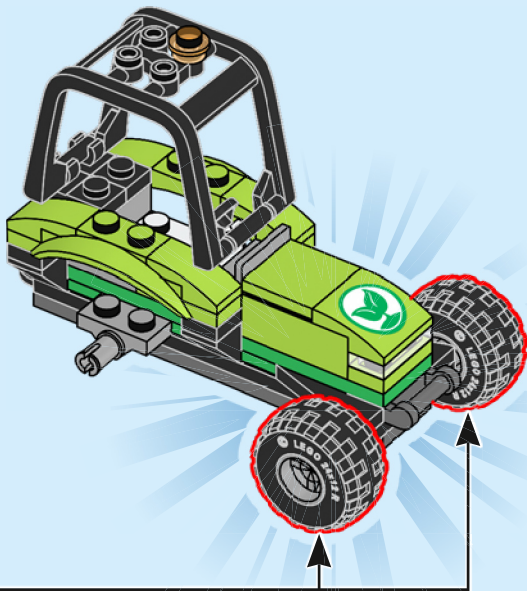

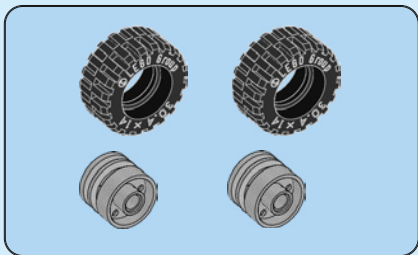

24

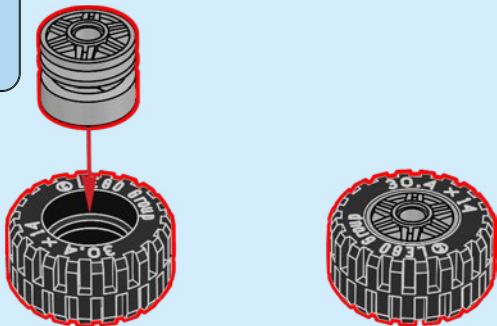

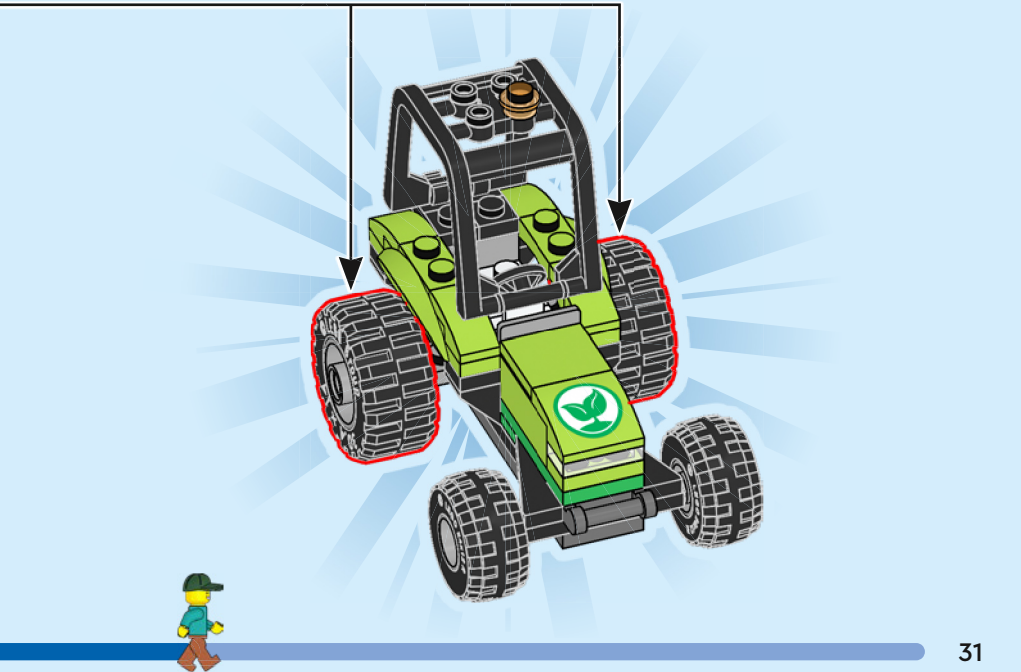

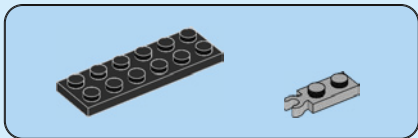
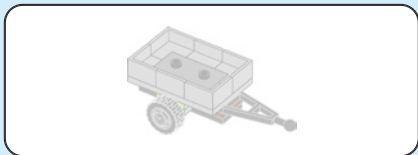

25

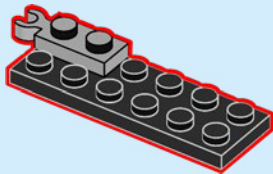



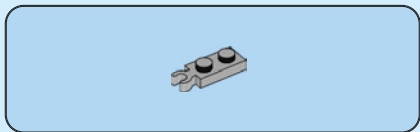

26

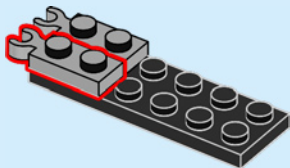

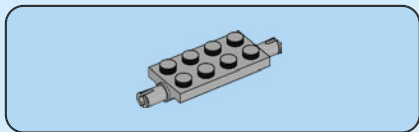

27

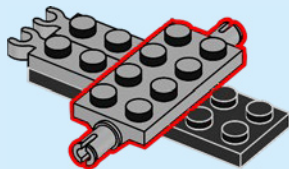



28

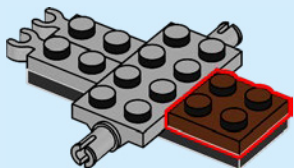



29

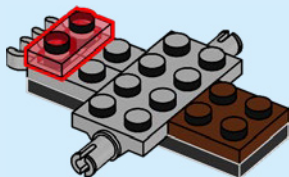

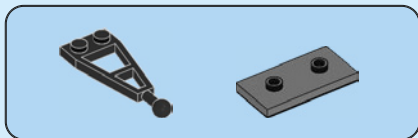

30

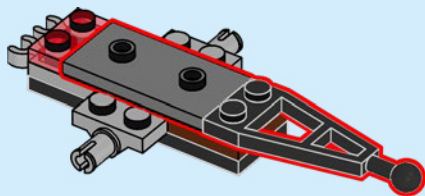

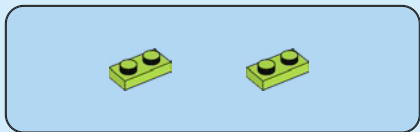

31

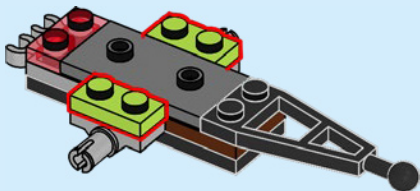

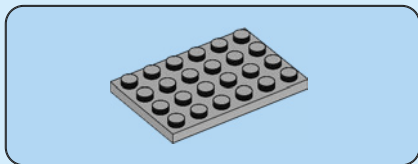

32

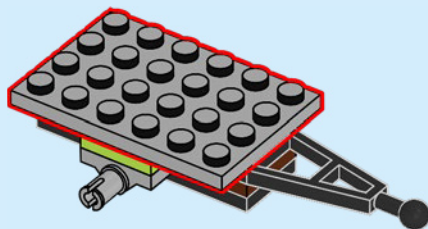

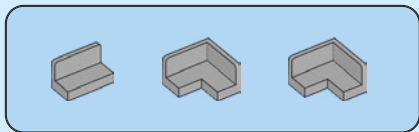

33

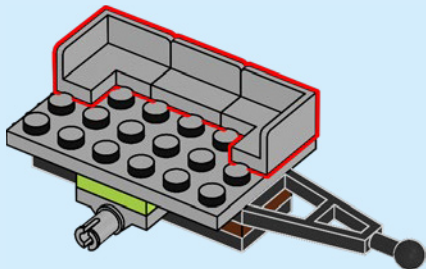



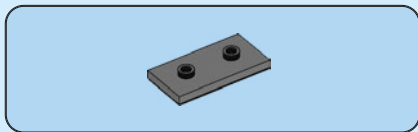

34

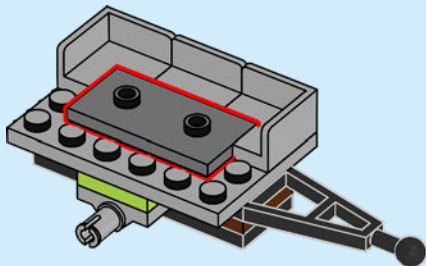

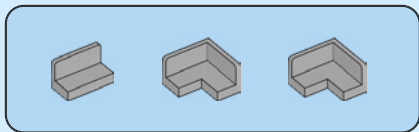

35

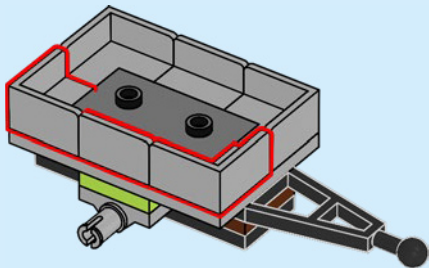

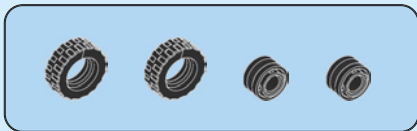

36

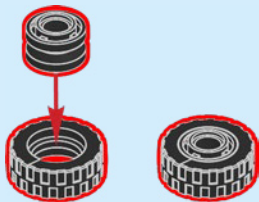

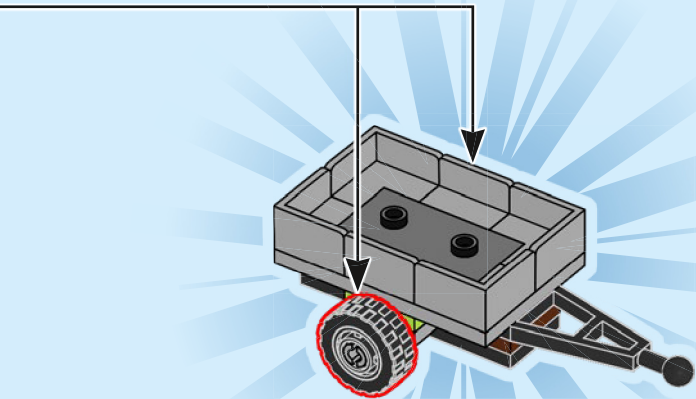

# 37

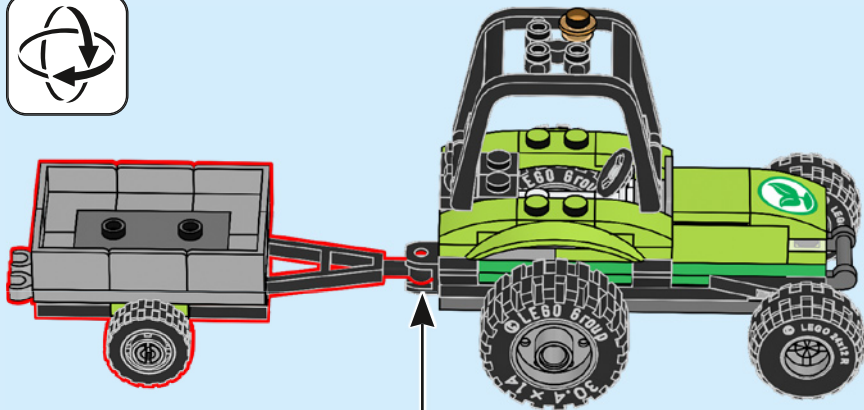
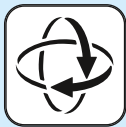

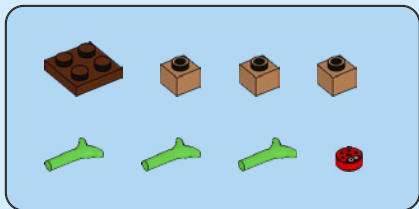

38

1



2



3



4



39

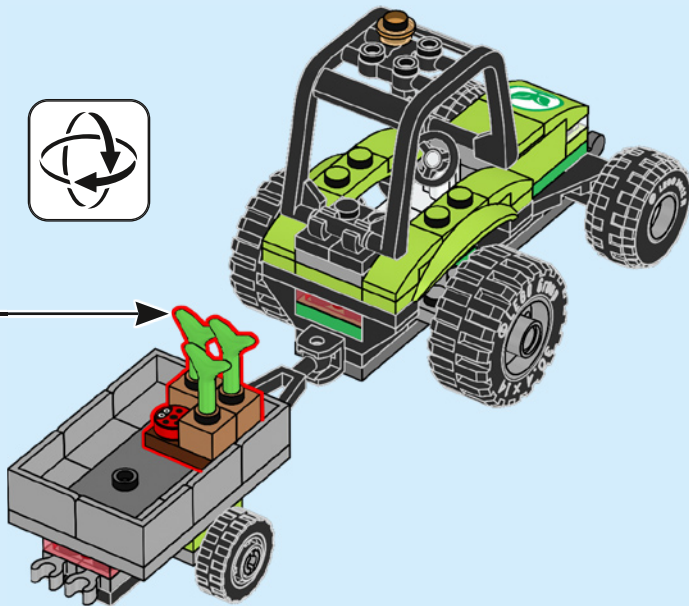





40

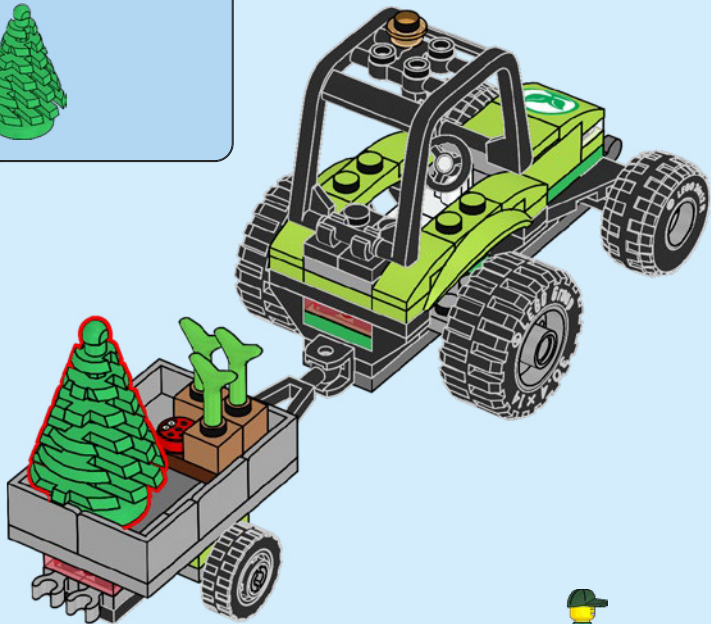



41

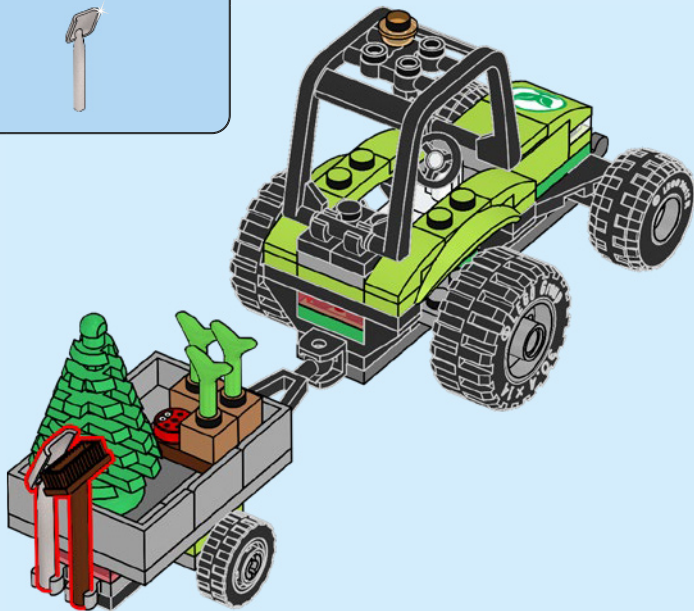





# CITY



60387



60383



60384



60389

60385





# CITY



60382



60371



60388



60386



60390



1x  
6218822



1x  
6324417



1x  
6153335



2x  
6291068



1x  
9551



2x  
6347310



2x  
4617848



1x  
6273226



2x  
6162541



2x  
6267482



1x  
6240526



2x  
371026



2x  
4619323



1x  
4274405



1x  
6170529



1x  
6338416

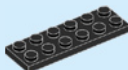

2x  
379526



3x  
306928



1x  
6268823

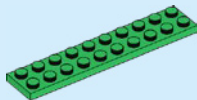

1x  
383228



3x  
4119479



1x  
6384077



1x  
6172566



2x  
6240204



2x  
6240212



1x  
6422682



4x  
4164037



4x  
6069006



1x  
6361353



1x  
4518611



1x  
6419160



1x  
6013530



1x  
4220631



2x  
6374801



1x  
6217106



1x  
6240227



1x  
4211157



2x  
4216695



2x  
4211764



3x  
6146223



2x  
6354568



4x  
6181755



2x  
6109684



1x  
6347992



2x  
6408542

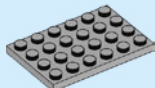

1x  
4211404



1x  
6146321



2x  
6307616

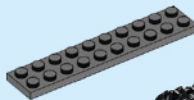

1x  
4210678



1x  
6210601



3x  
6383946



1x  
6395410



[LEGO.com/service](https://www.LEGO.com/service)

YOU COULD

WIN



Scan this QR code or go to  
**LEGO.COM/PRODUCTFEEDBACK** and give us  
your short feedback about this LEGO® set  
for a chance to win a cool LEGO prize.

Terms and Conditions apply\*

**DE: Du könntest GEWINNEN.** Es gelten die Teilnahmebedingungen\* **FR: Tu pourrais GAGNER.** Des conditions s'appliquent\* **IT: Potresti VINCERE tu.** Termini e condizioni sono applicabili\* **ES: Puedes GANAR.** Aplican términos y condiciones\* **PT: Poderá GANHAR.** Aplicam-se termos e condições\* **JA: プレゼント付き! 利用規約が適用されます\* ZH: 轻松获奖. 条款和条件适用\*** **KO: 상품의 주인이 되어보세요. 소정의 약관이 적용됩니다\*** **RU: Вы можете ВЫИГРАТЬ.** Действуют положения и условия\* **PL: Szansa na WYGRANĄ.** Obowiązują warunki korzystania\* **CS: Máte šanci VYHRÁT.** Platí všeobecné smluvní podmínky\* **SK: Máte šancu VYHRATĚ.** Platia všeobecné zmluvné podmienky\* **HU: TE IS NYERHETSZ.** Felhasználási feltételek érvényesek\* **RO: Ai putea CĂȘTIGA.** Se aplică termenii și condiții\* **BG: Можете да СПЕЧЕЛИТЕ.** Има определени правила и условия\* **LV: Tu vari LAIMĒT.** Ir spēkā noteikumi un nosacījumi.\* **ET: Sul on võimalus VÕITA.** Kehtivad tingimused\* **LT: Jūs galite LAIMĖTI.** Taikomos sąlygos\*

\*[LEGO.com/productfeedback-terms](https://www.lego.com/productfeedback-terms)

LEGO and the LEGO logo are trademarks of the/son des marques de commerce du/  
son marcas registradas de LEGO Group. ©2023 The LEGO Group.

6444470