

Architect



3112



3113



3114



3115



FIRST-RATE SERIES

Architect

BRICKS TOYS
BRIGHT COLORS



Roaring Power

3116

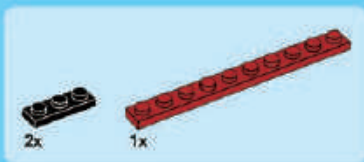
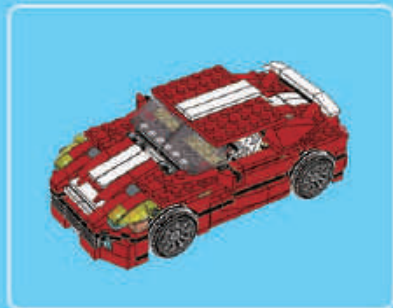

1

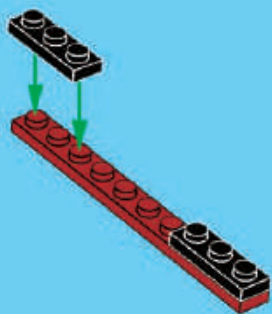

2

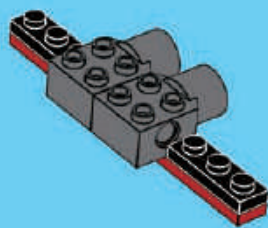

BRICKS TOYS

BRIGHT COLORS



3101



3102



3103



3104



3105



3106



3107



3108



3109



3110



3111



3

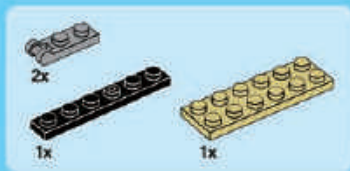
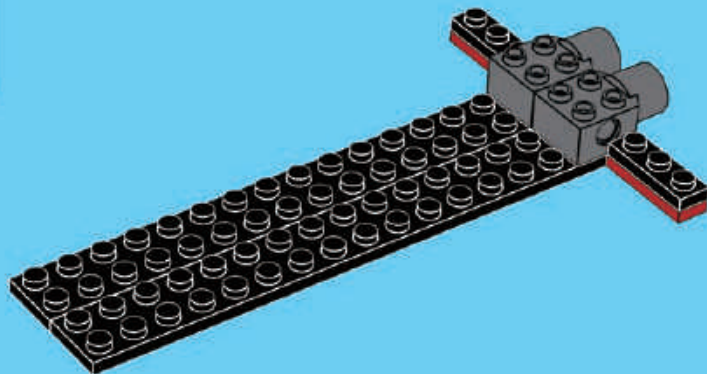

4

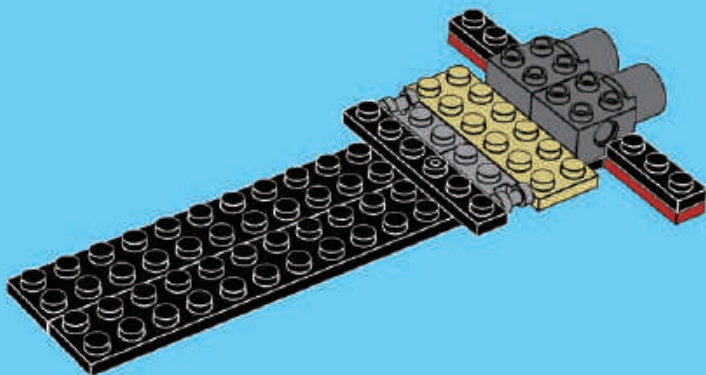

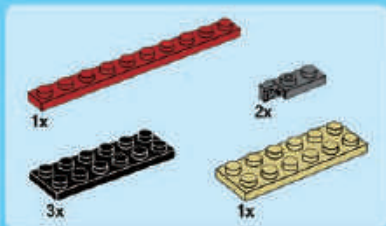

5

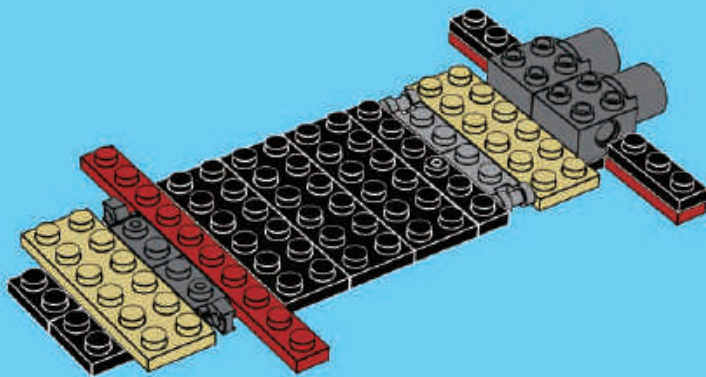

6

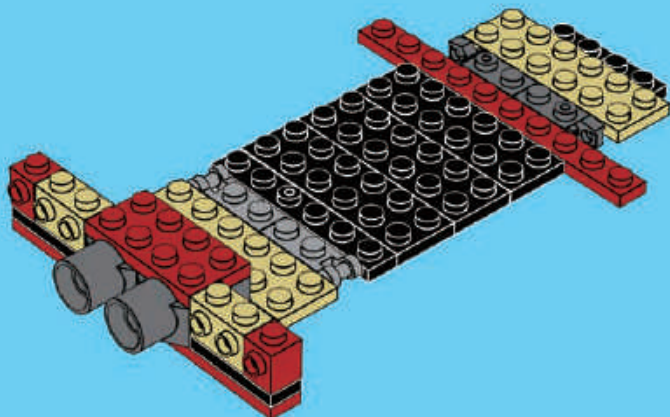



7

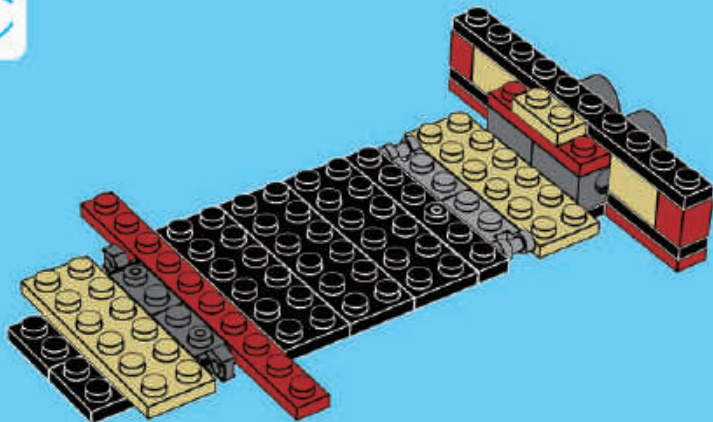



2x



1x



1x



1x

8

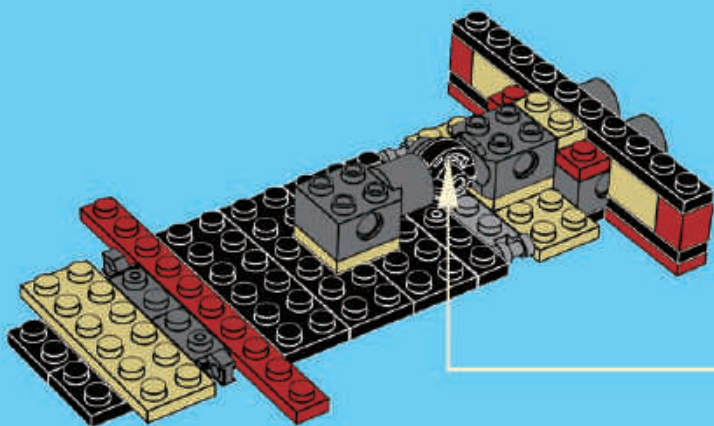

1



2

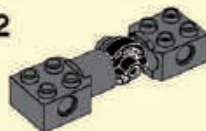

3

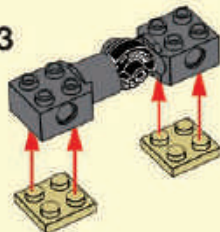

4

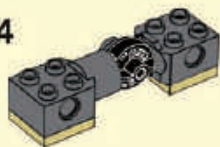



2x



1x



2x

9

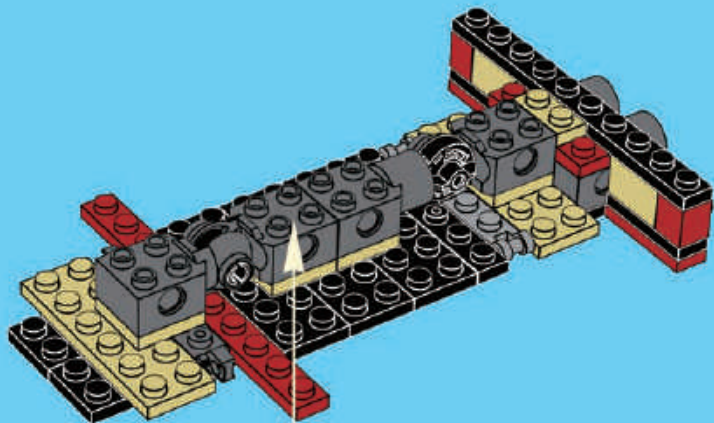

1



2

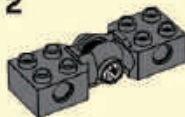

3

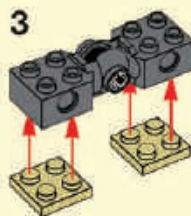

4

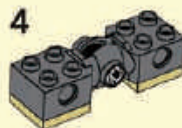

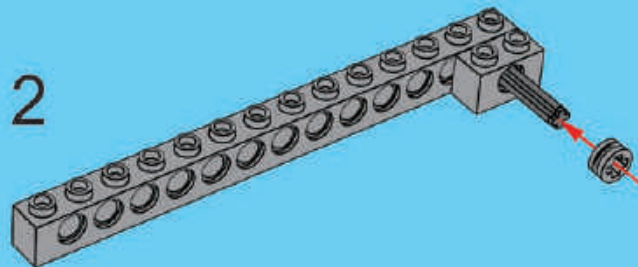
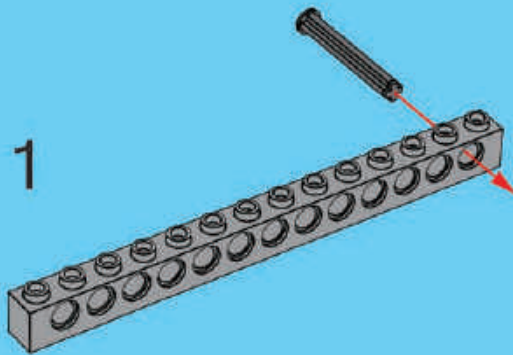
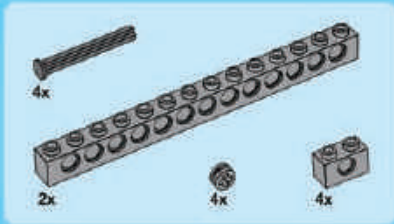

3

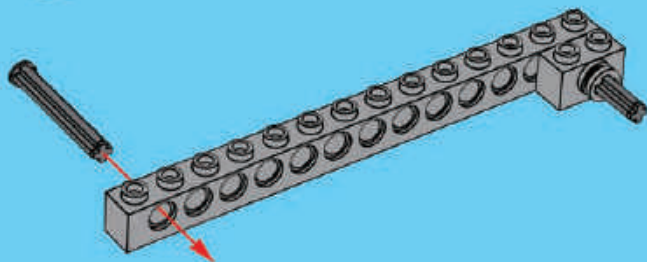

4

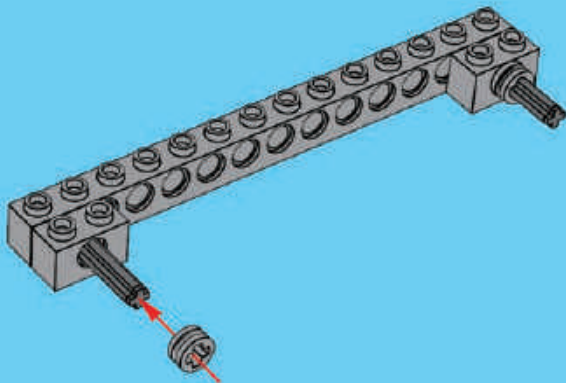

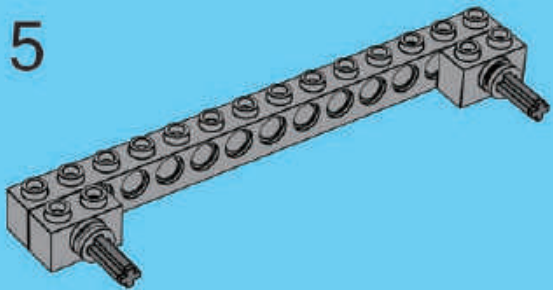

2x

10

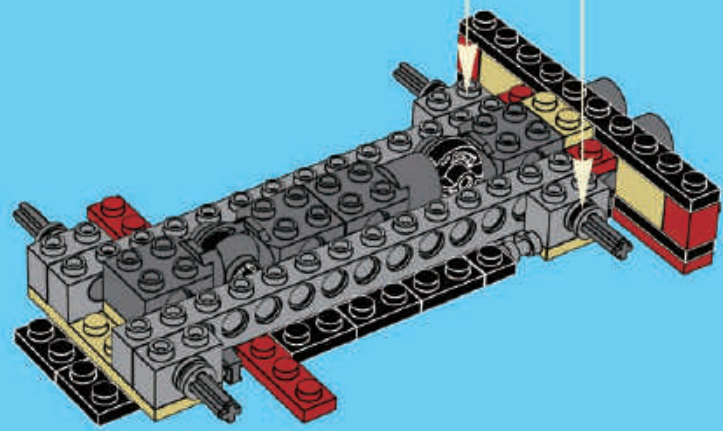



1x

1



1x

2

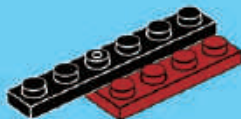

1x

3

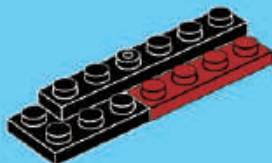

1x



1x

4

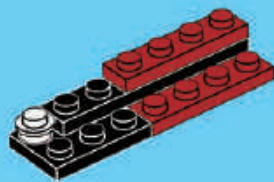

1x



2x

5

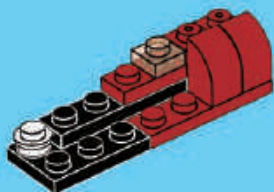



1x



1x

6

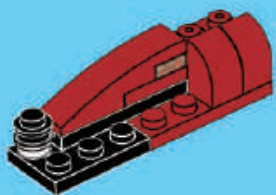

1x

7

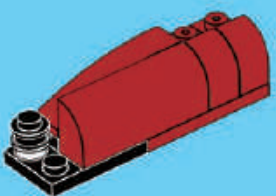

1x

8

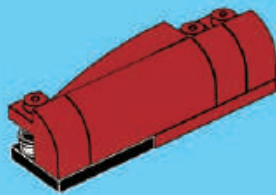

1x



1x

9

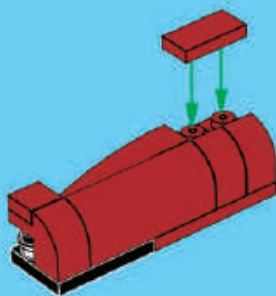

13

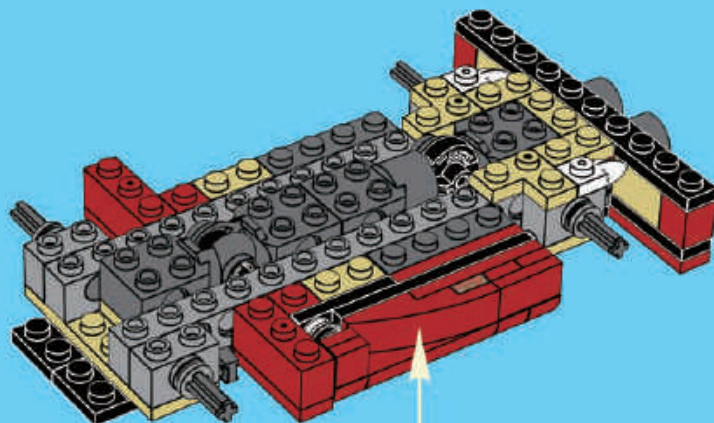



1x

1

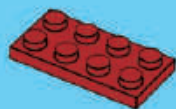

1x

2

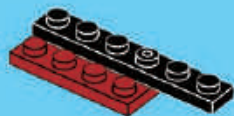

1x

3

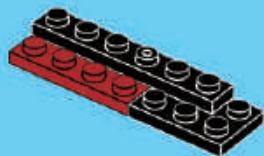

1x



1x

4

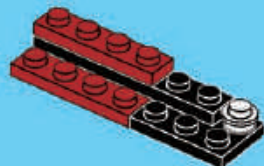

2x



1x

5

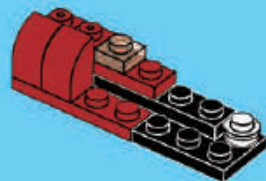

1x

1x

6

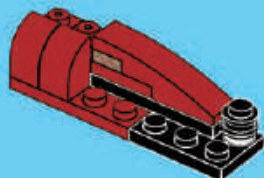

1x

7

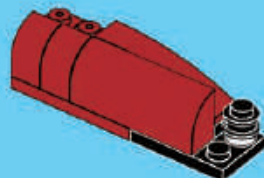

1x

8

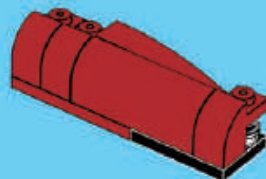

1x



1x

9

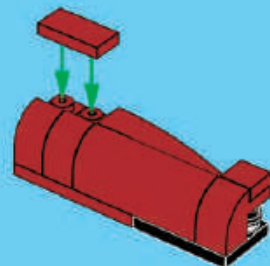

14

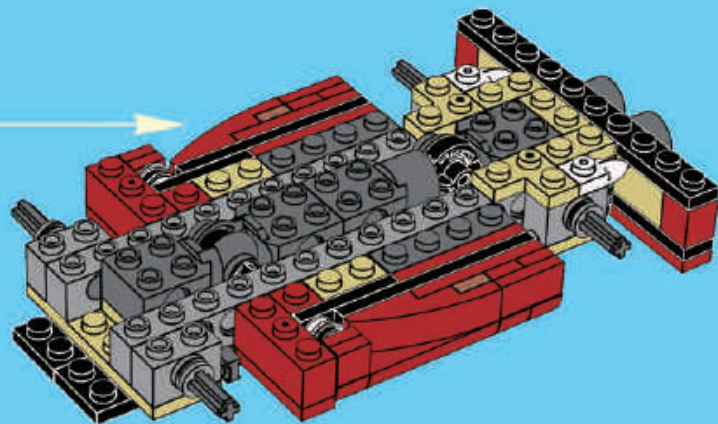

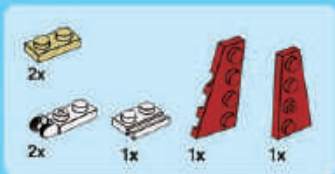

15

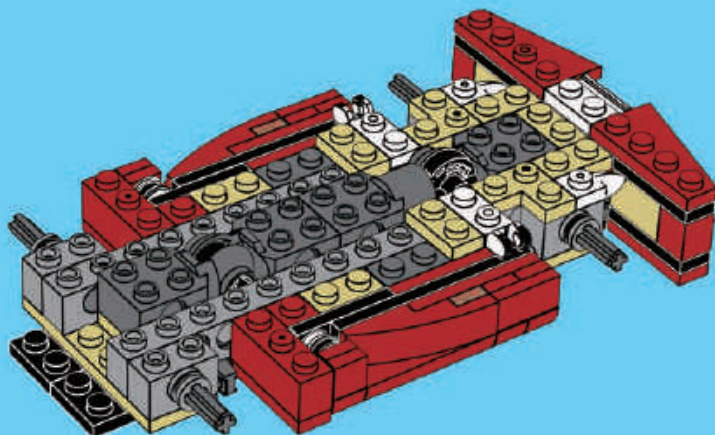

16

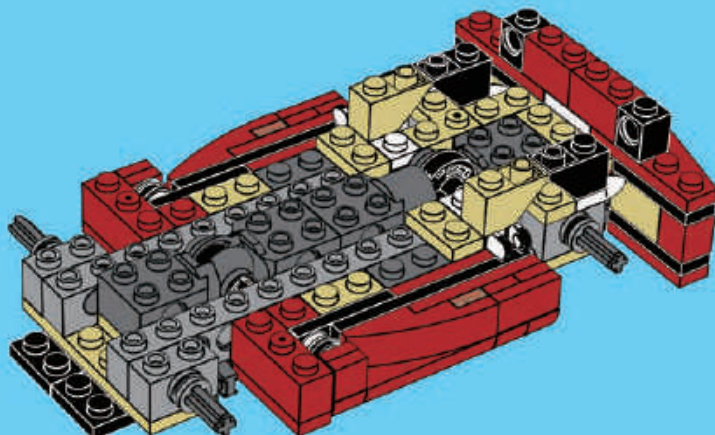



1x



2x

17

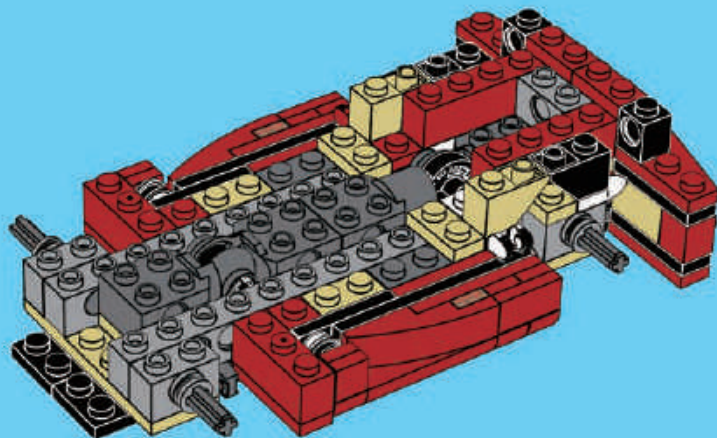

2x

2x



1x

18

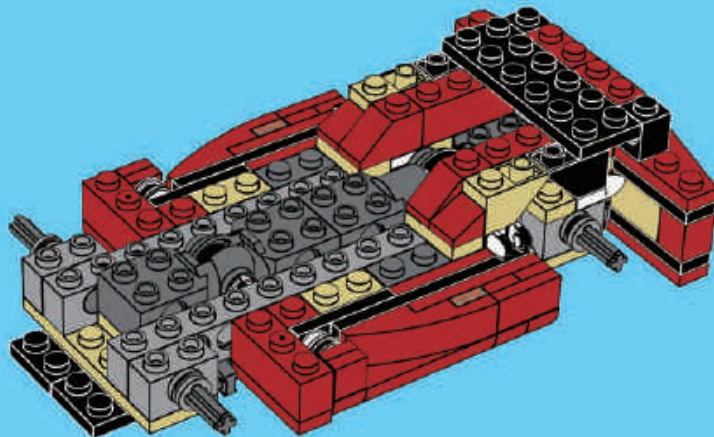



2x



4x



4x

19

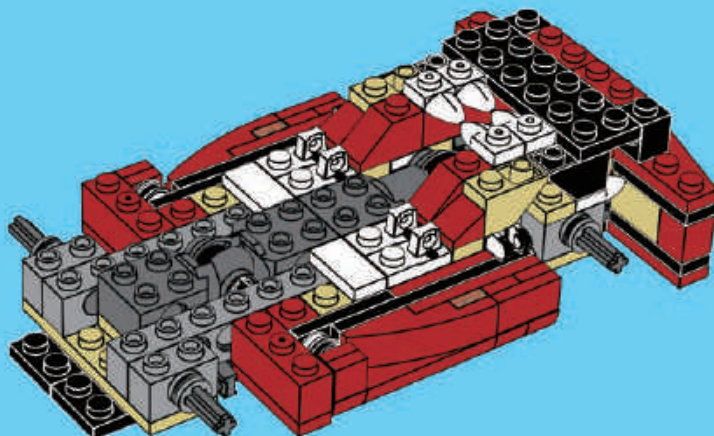

1x



1x



2x

20

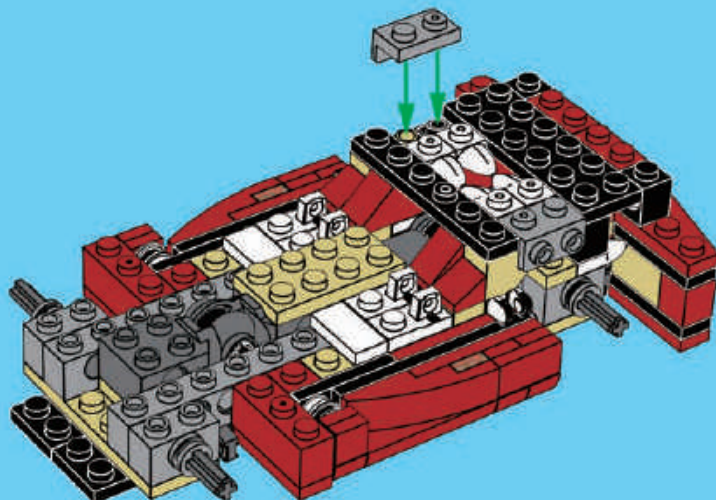



2x



2x

21

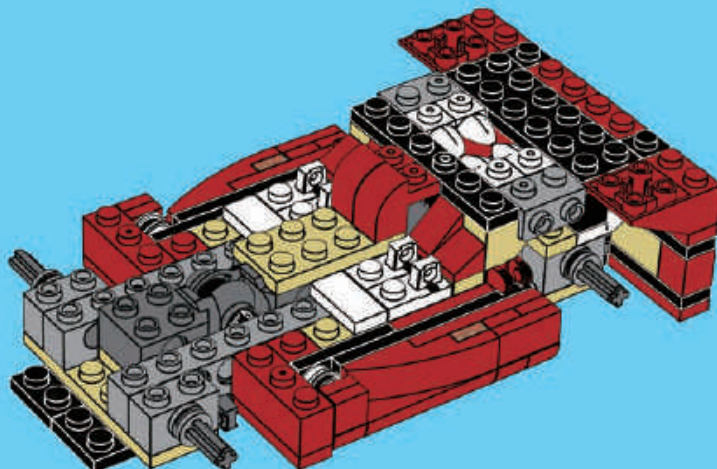

1x



1x

22

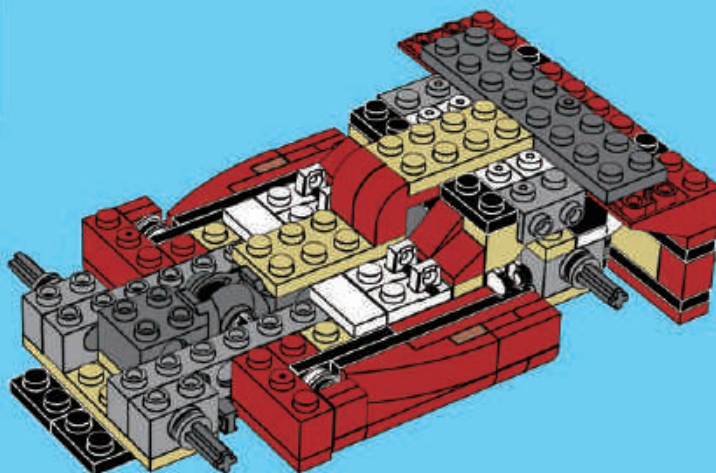



23

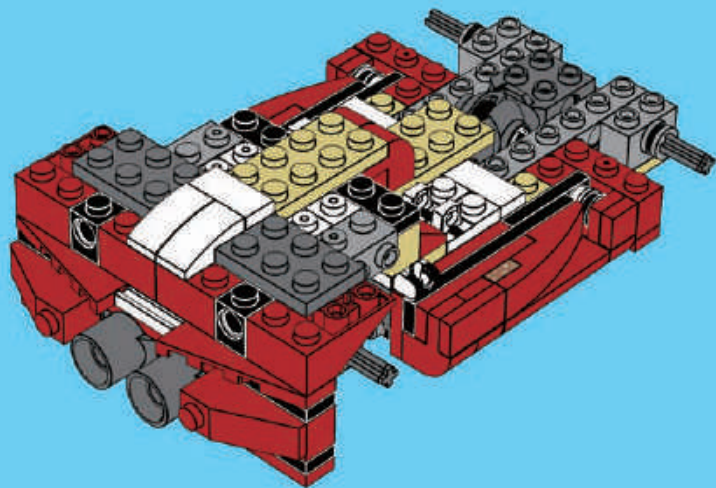

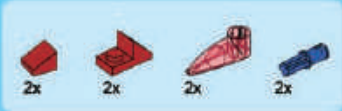

24

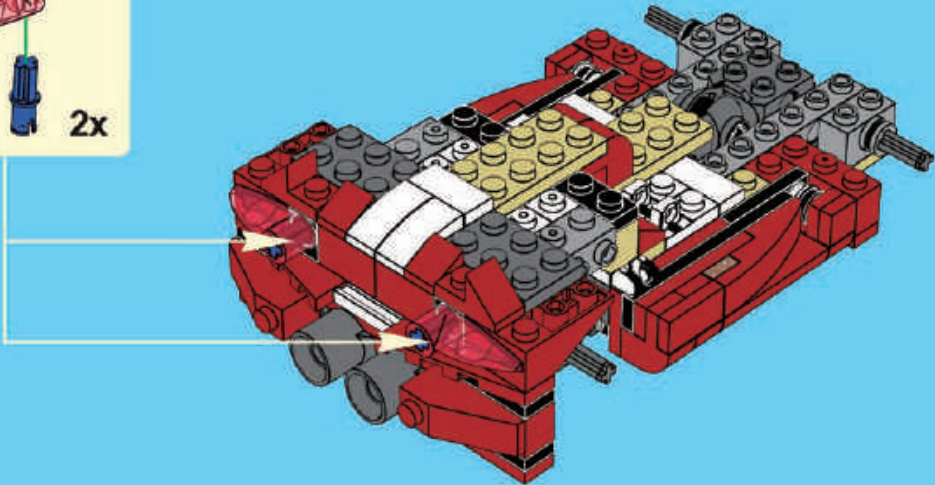



25

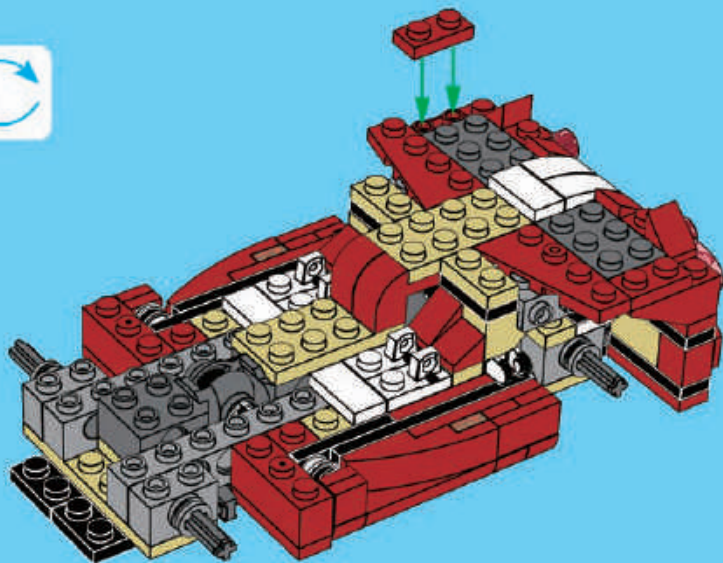



1x



2x

26

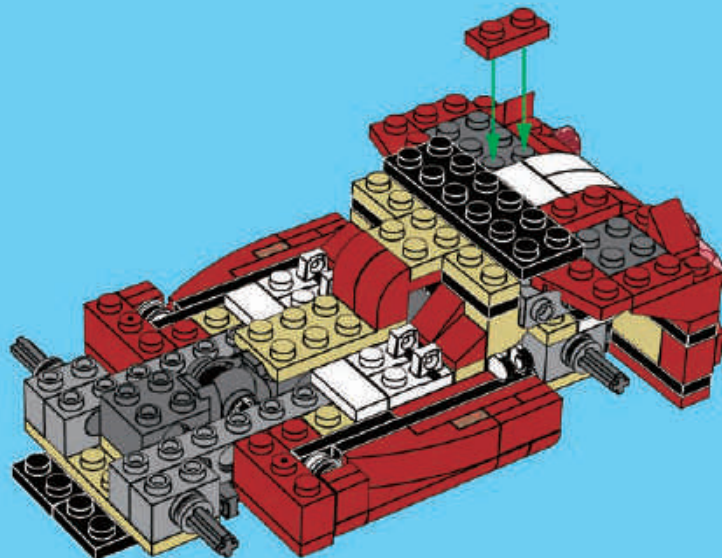

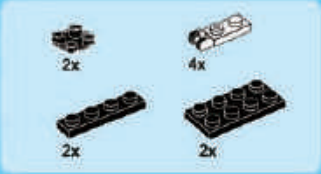

27

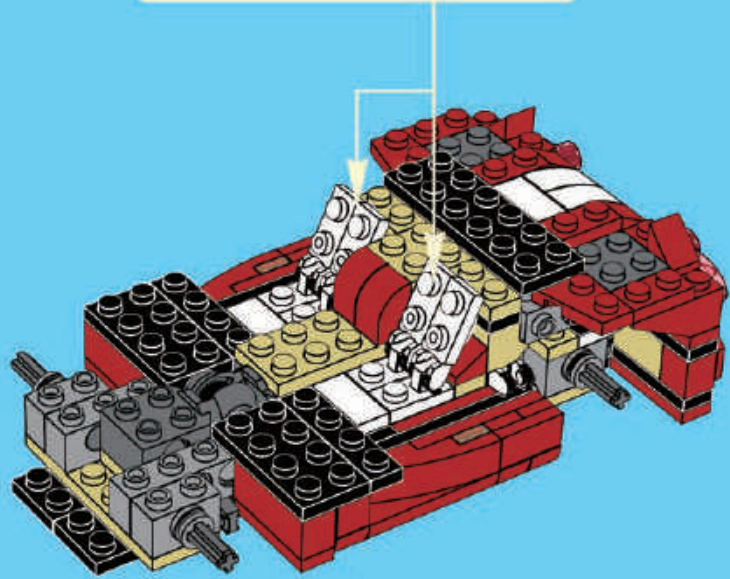
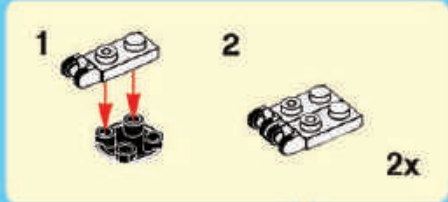



28

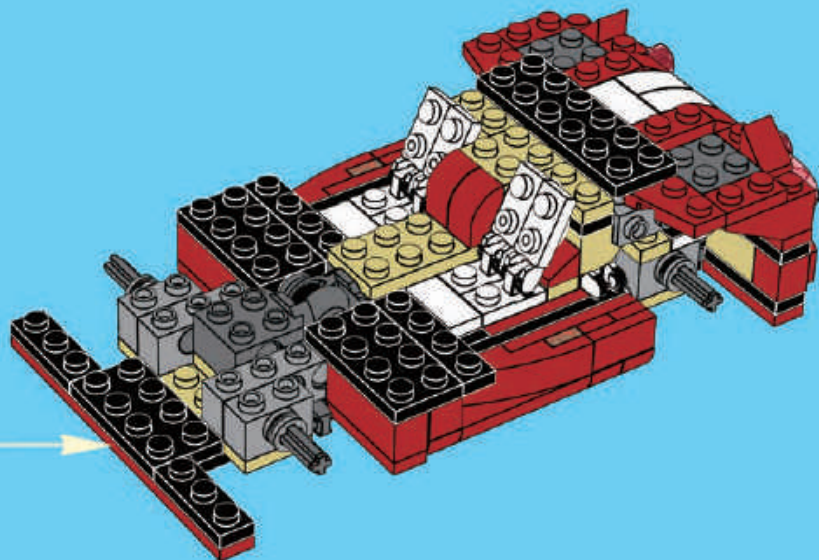
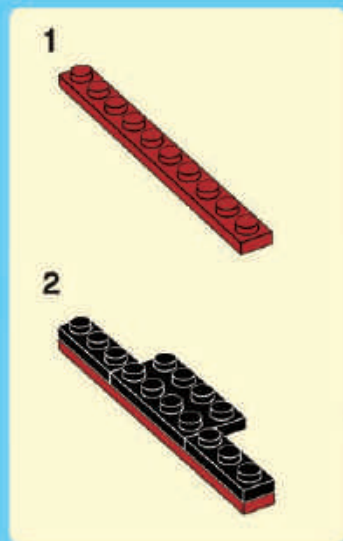



4x



2x



1x

29

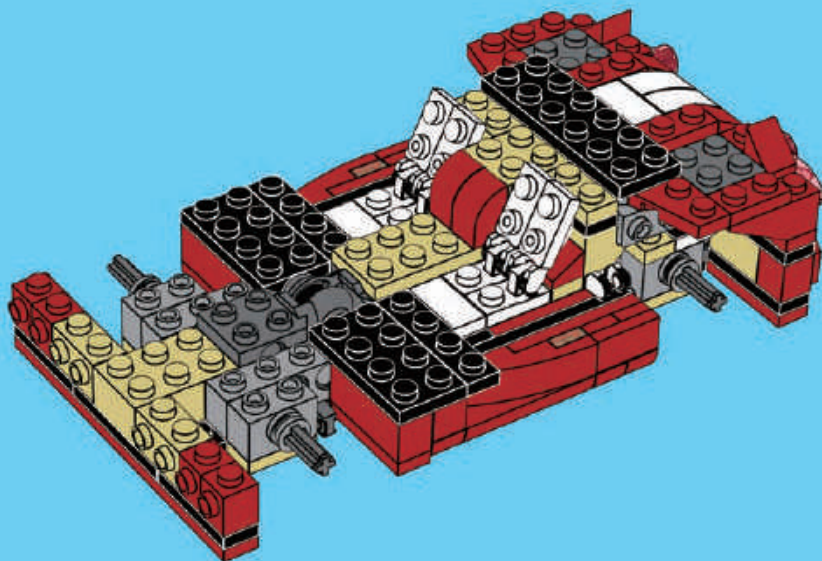



2x



1x



2x

30

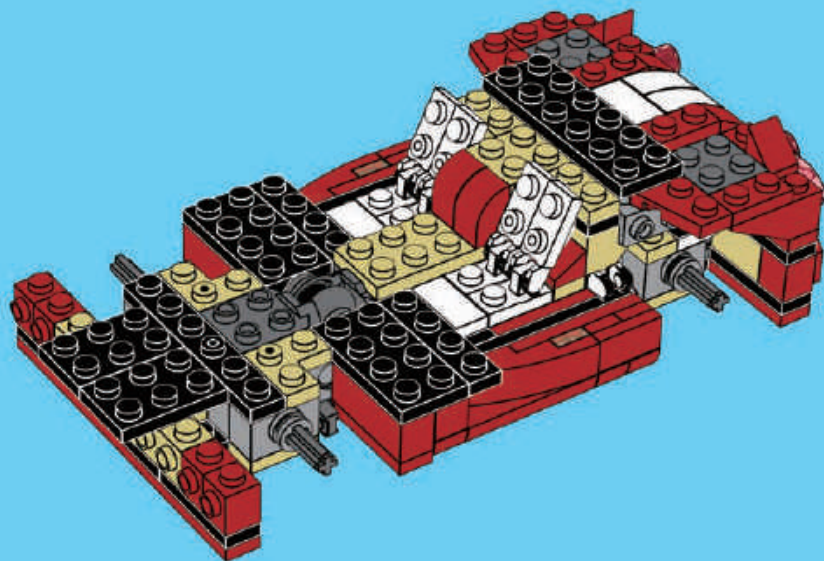

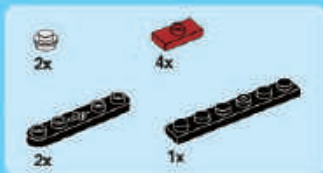

31

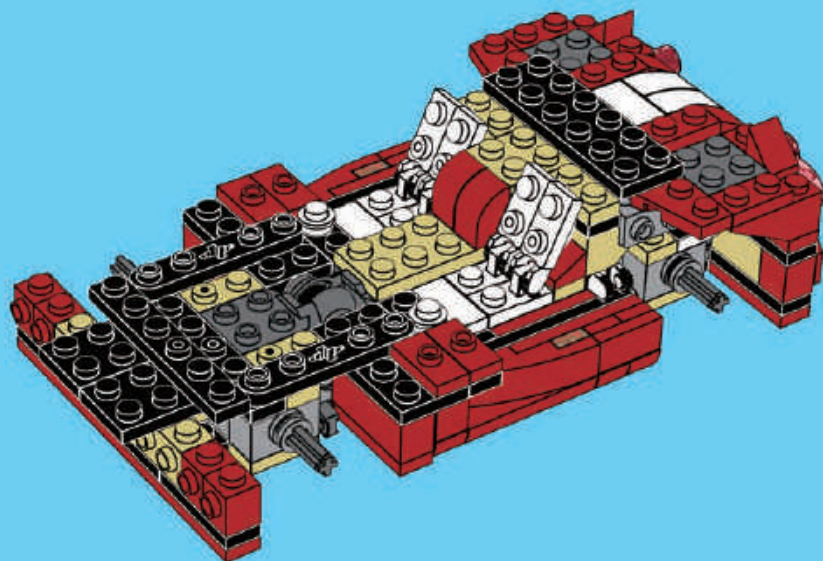

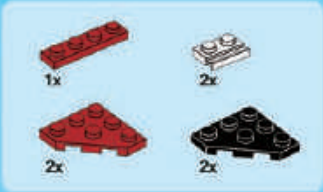

32

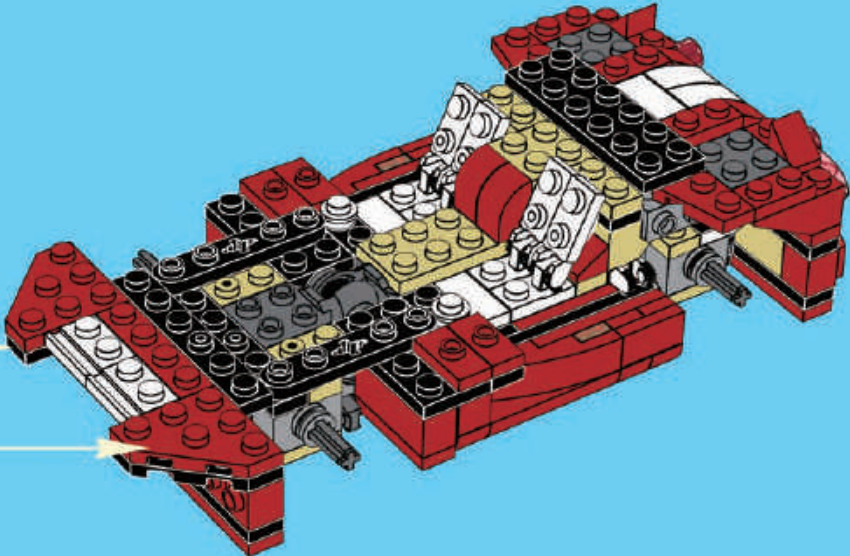
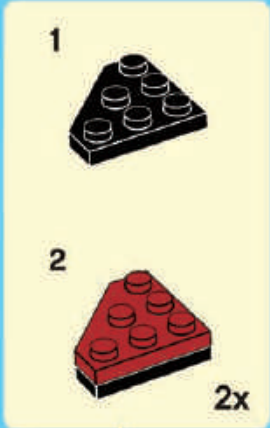

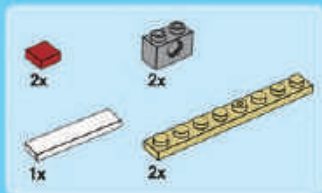

33

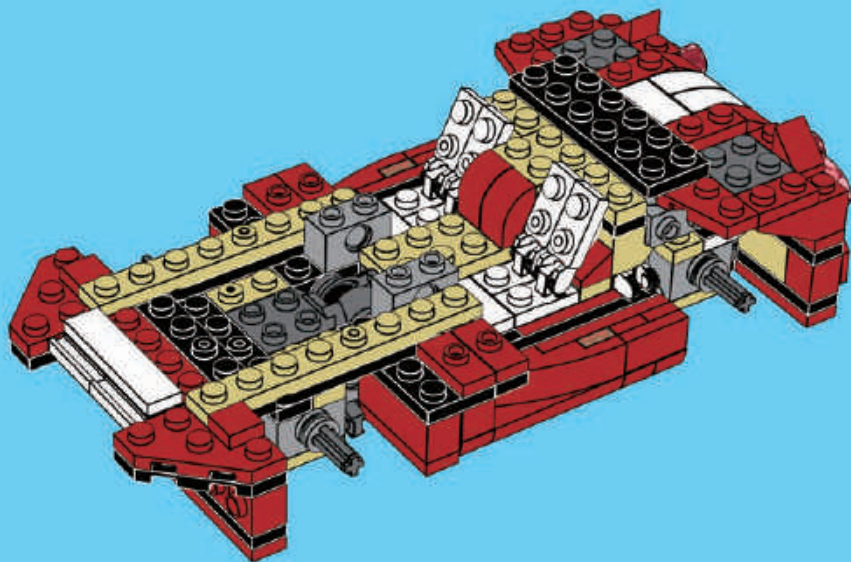



2x

1

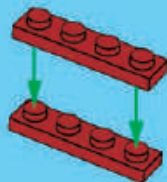

1x



2x

2



1x

3

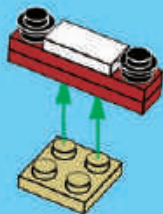

2x

4

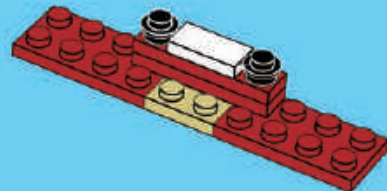

2x

5

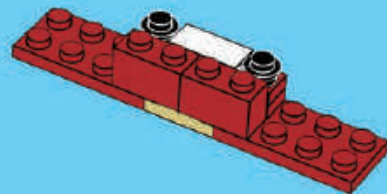



2x



2x

6

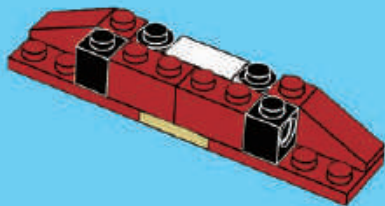

2x



2x



2x

7



2x

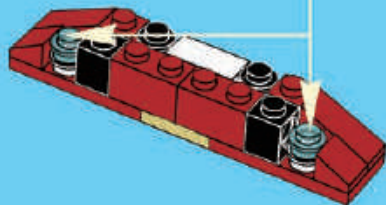

2x



3x

8

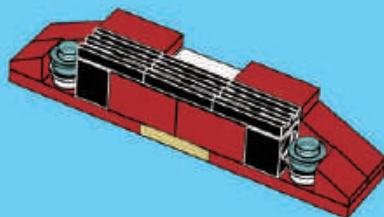

34

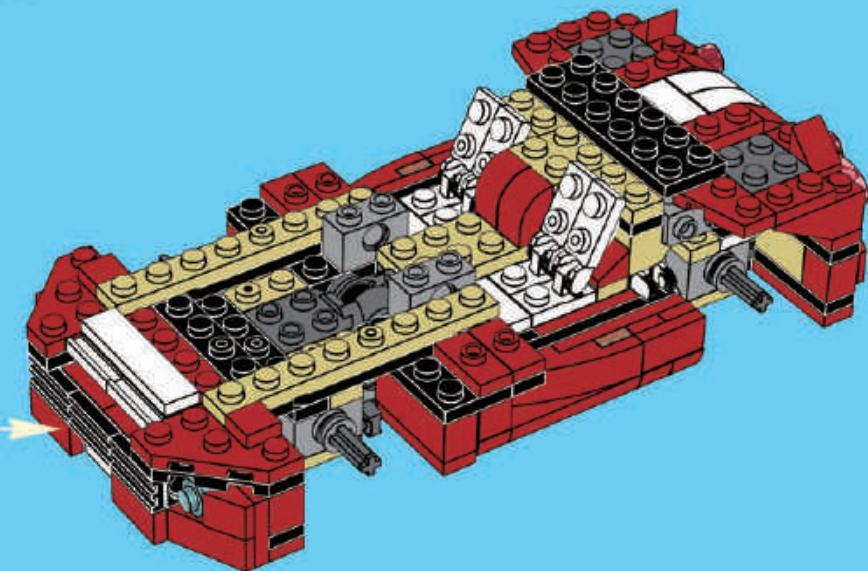



35

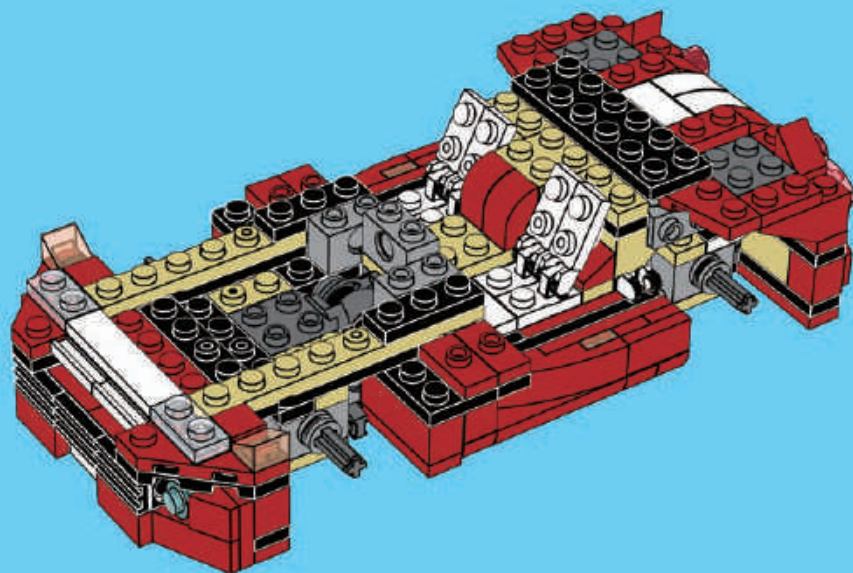



1x



1x



1x



1x

36

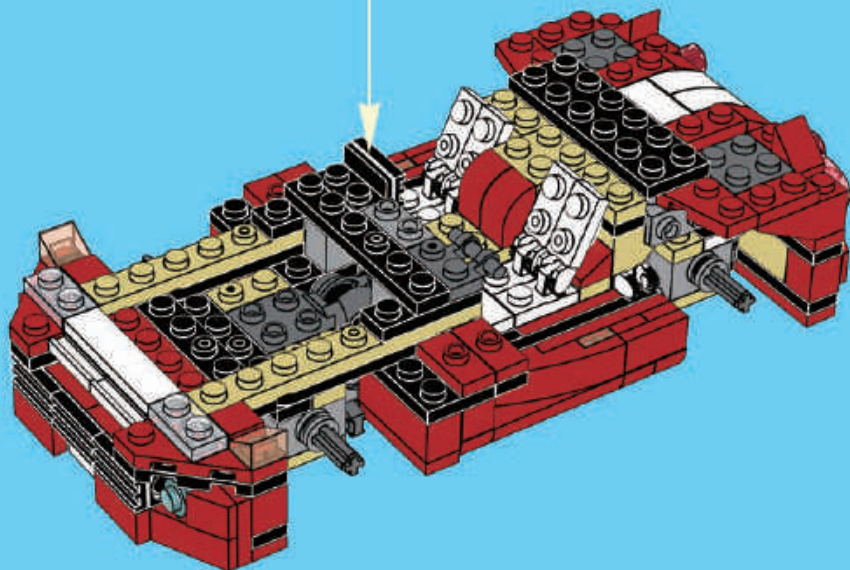



1x

1



1x



1x

2

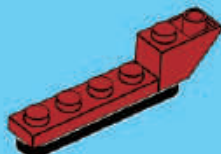

2x

3

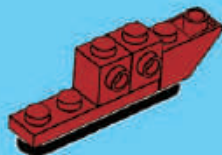

2x

4

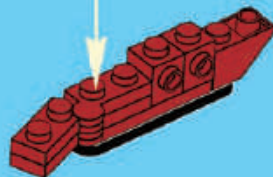
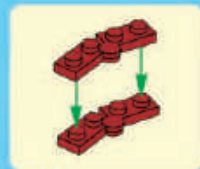

1x



1x

5

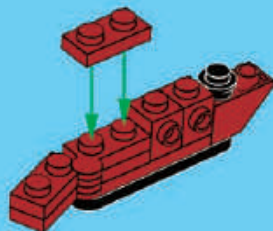



6

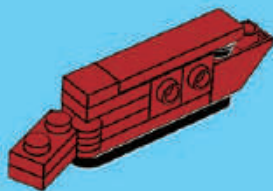

7

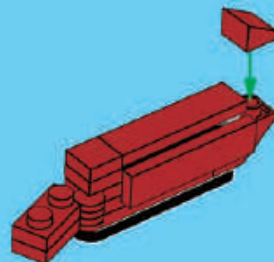

37

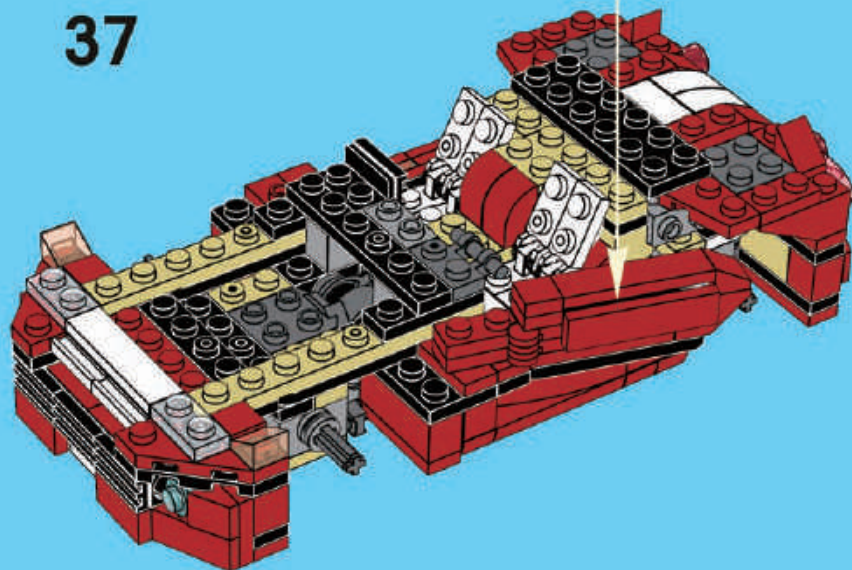



1x

1



1x



1x

2

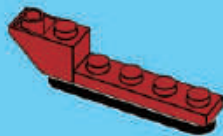

2x

3

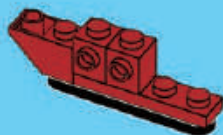

2x

4

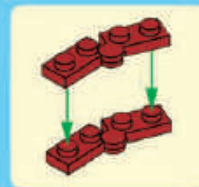

1x



1x

5

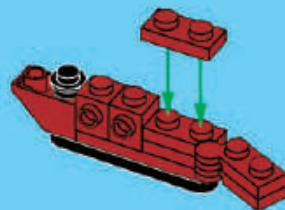



6

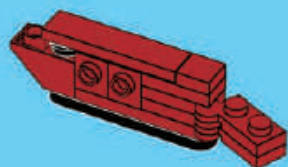

7

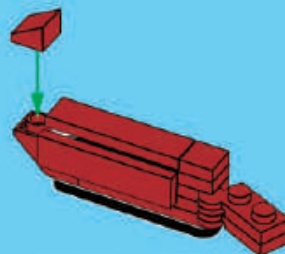

38

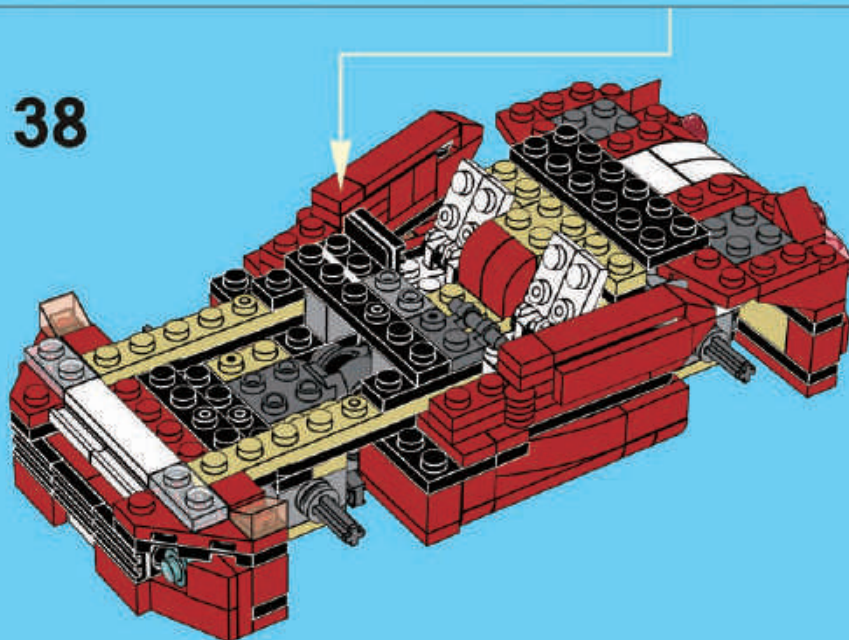



2x



2x



2x



1x

39

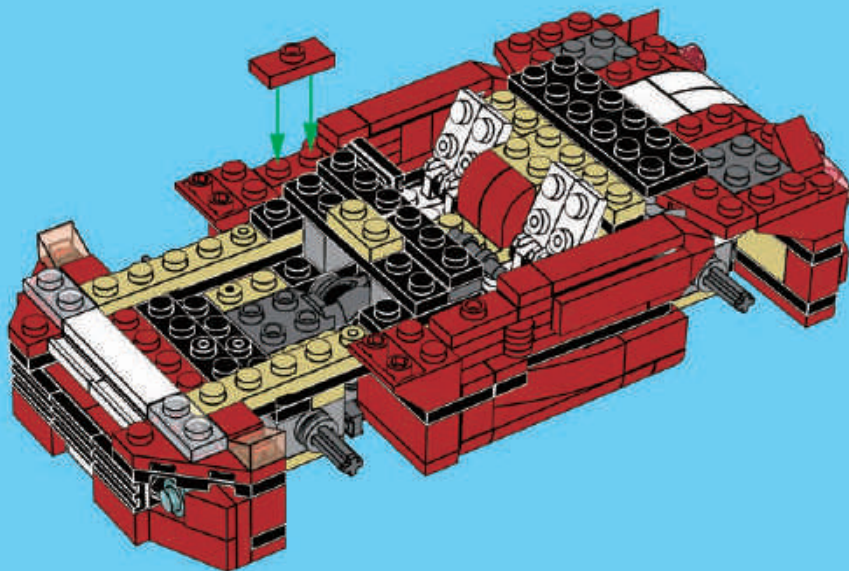



40

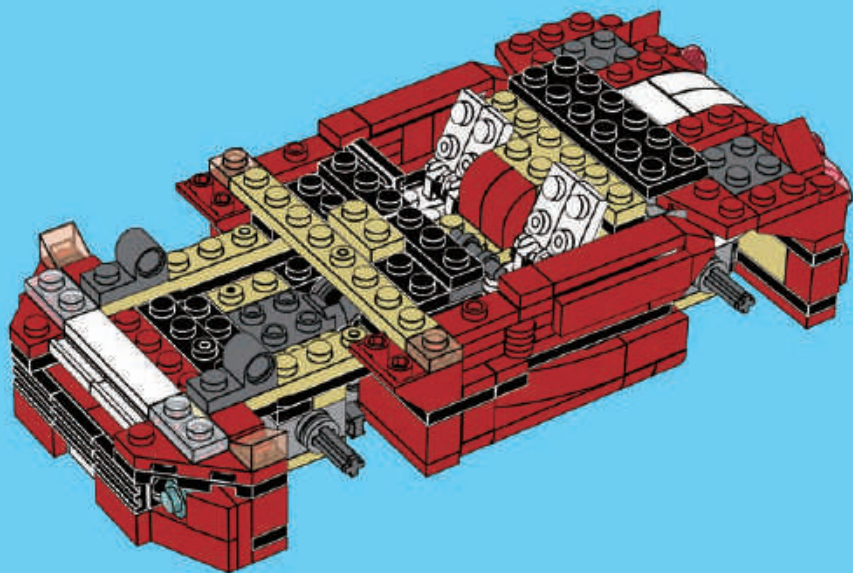



41

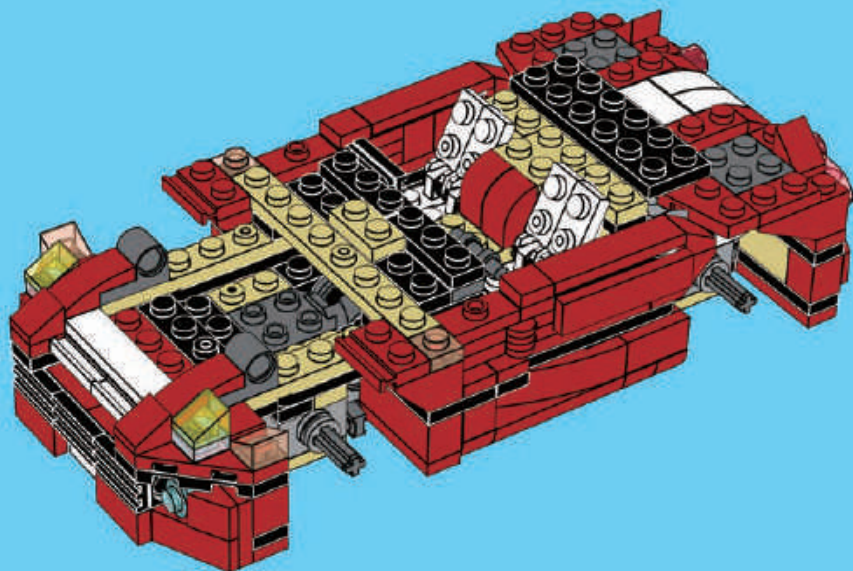



42

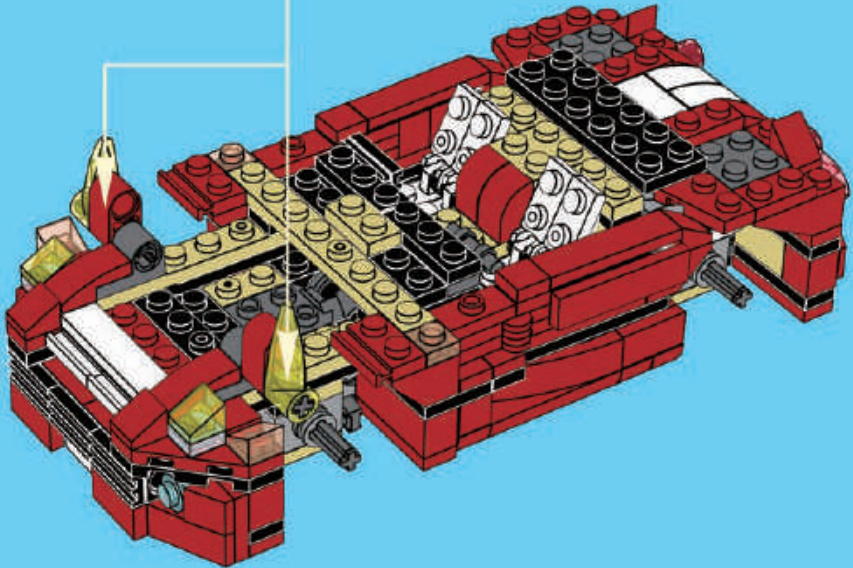
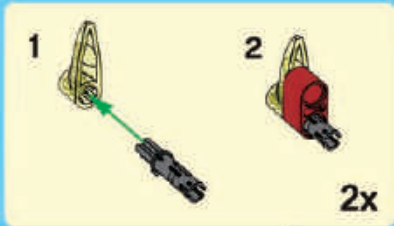



1x



4x

43

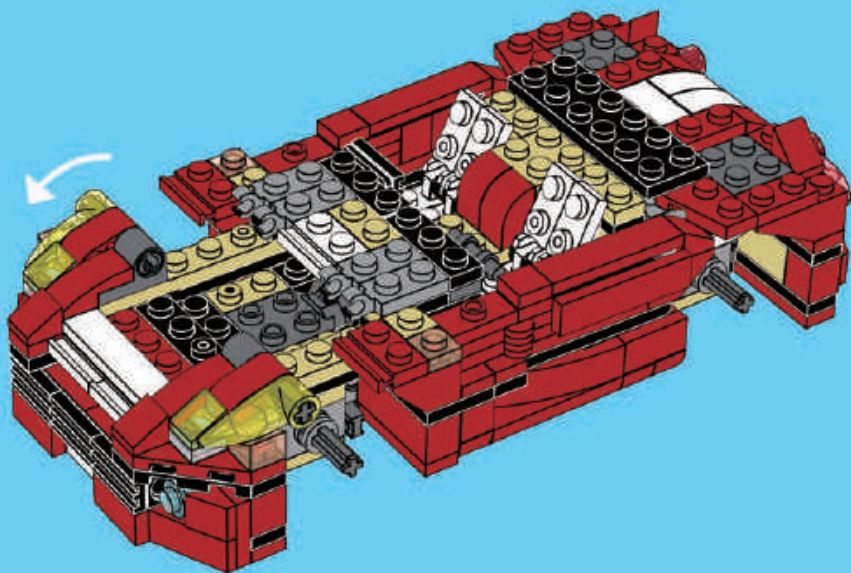



44

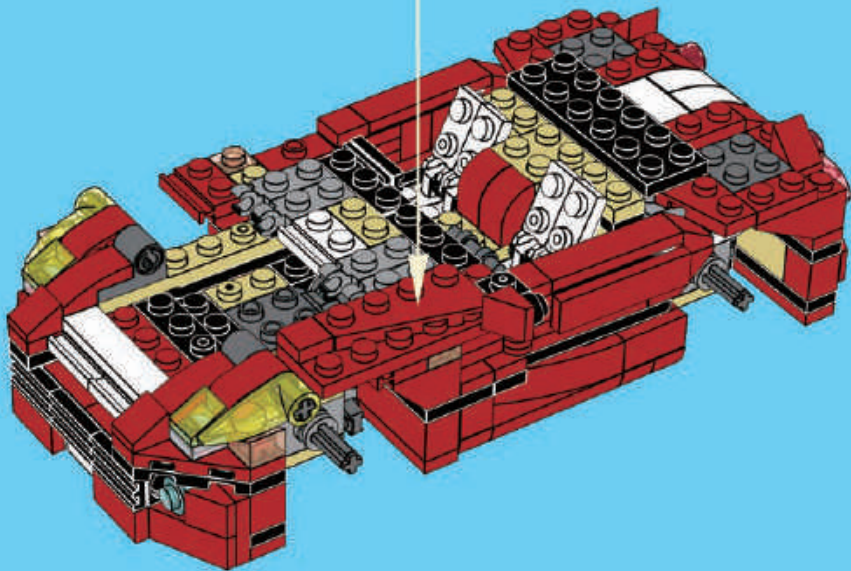
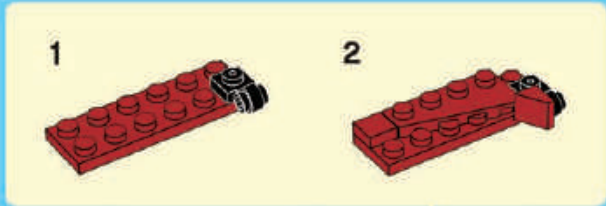



45

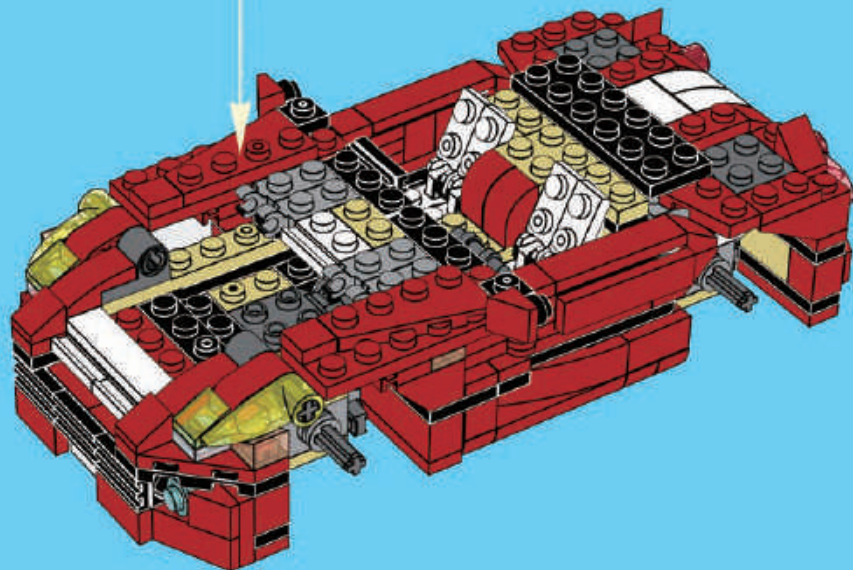
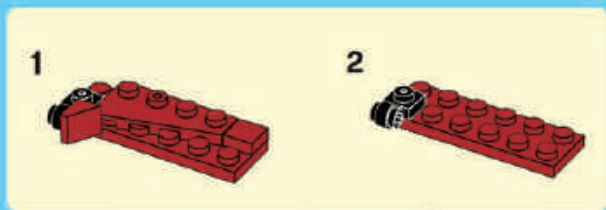

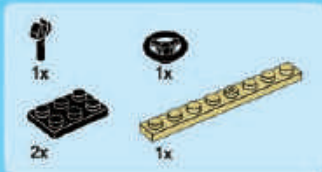

46

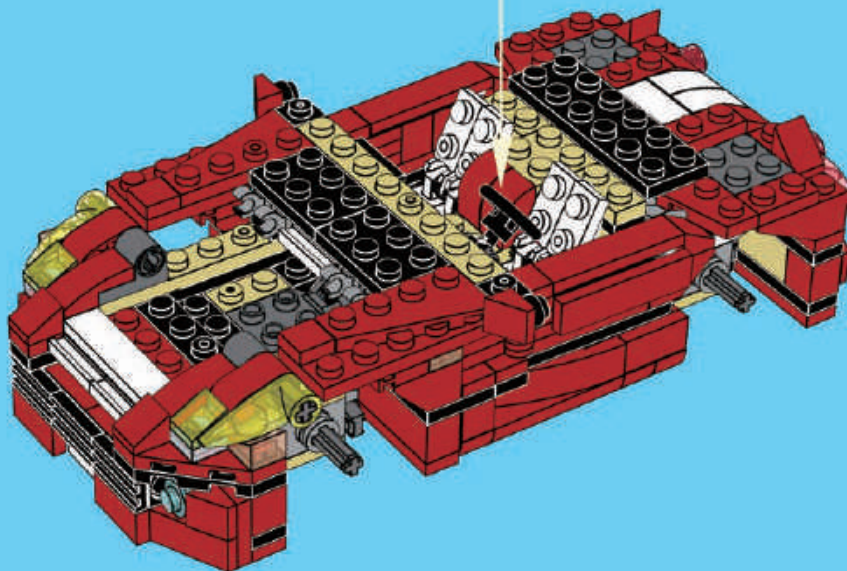



1x

1



1x

2



1x

3



2x



2x

4



2x



2x

5

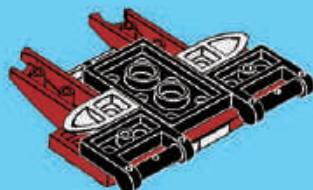



2x

6

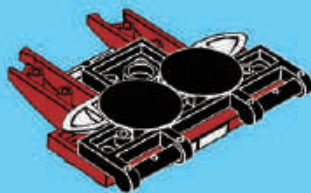

7

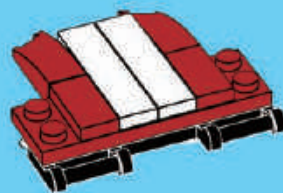

47

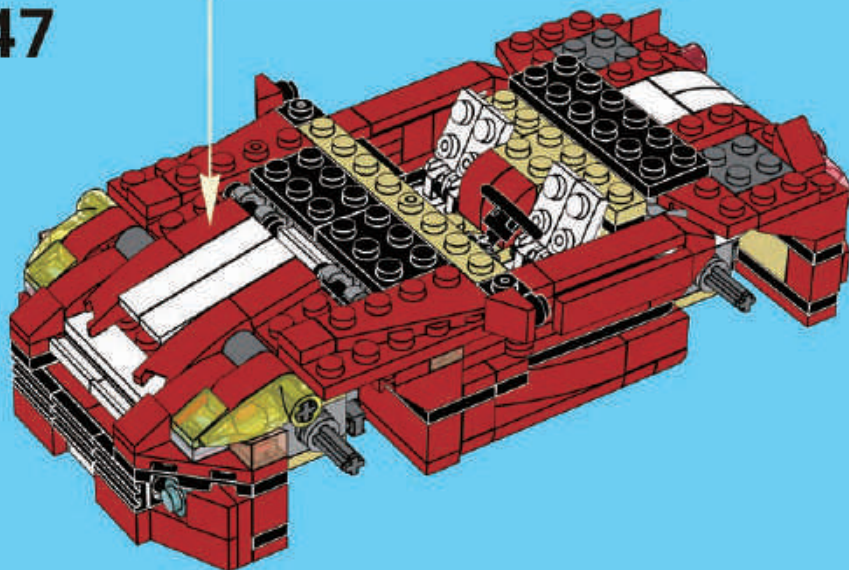

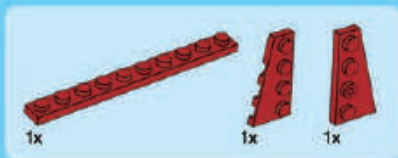

48

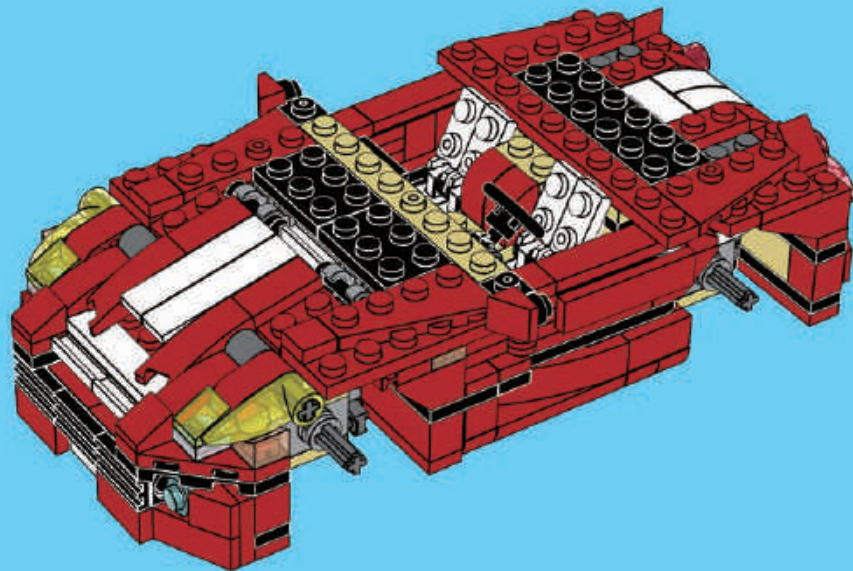



2x



2x

49

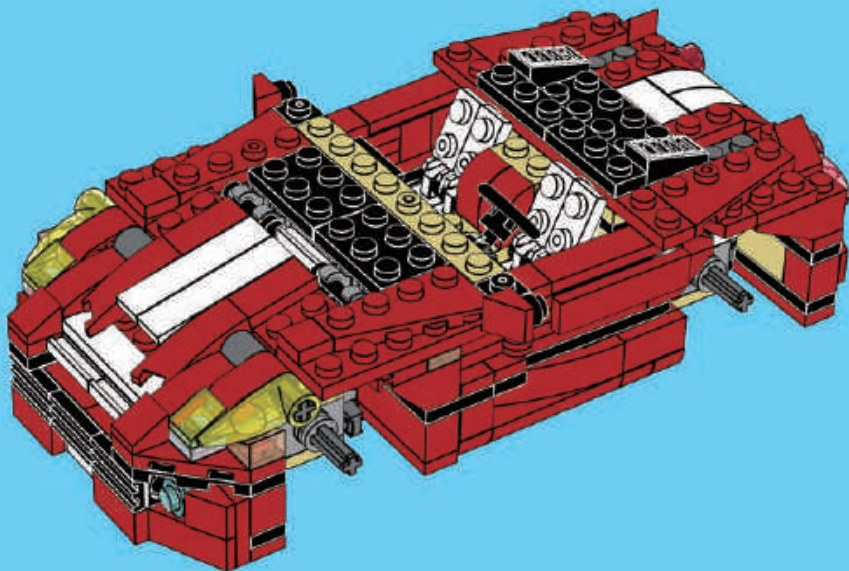

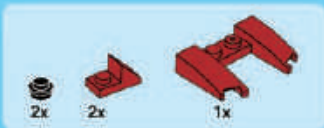

50

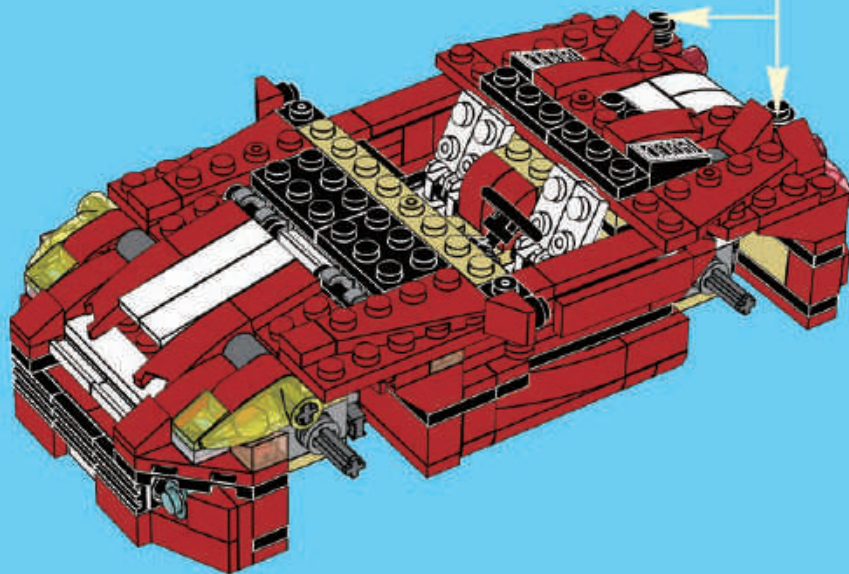



2x



1x

51

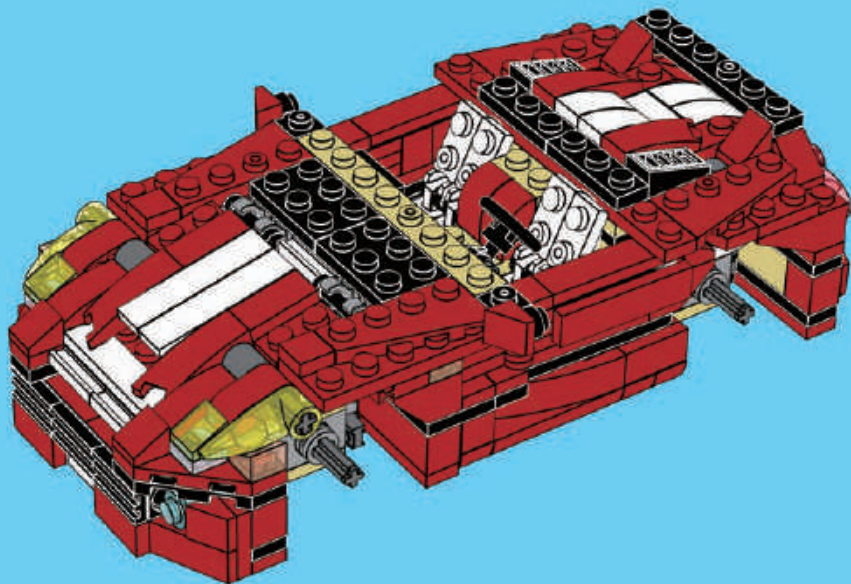

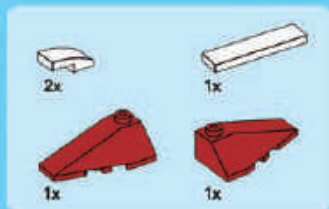

52

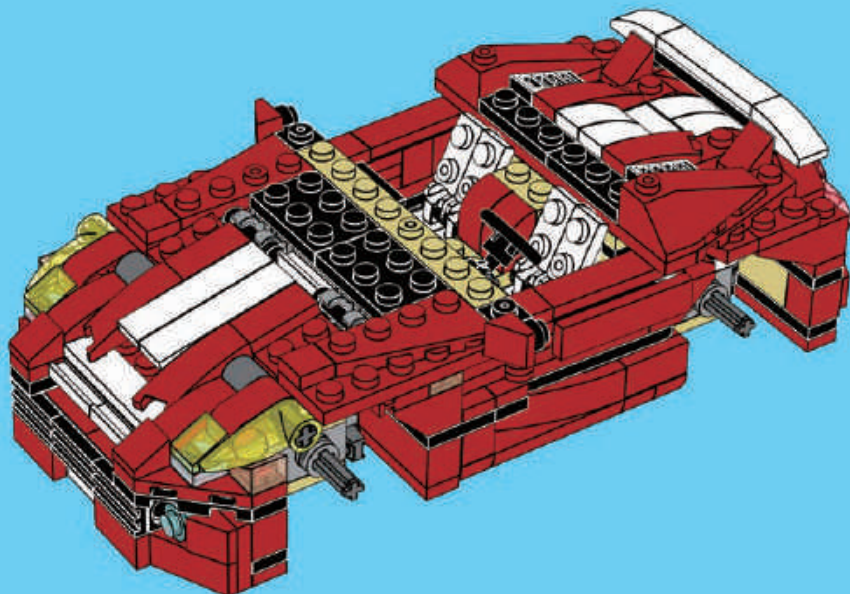

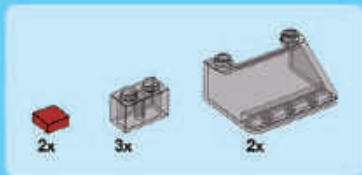

53

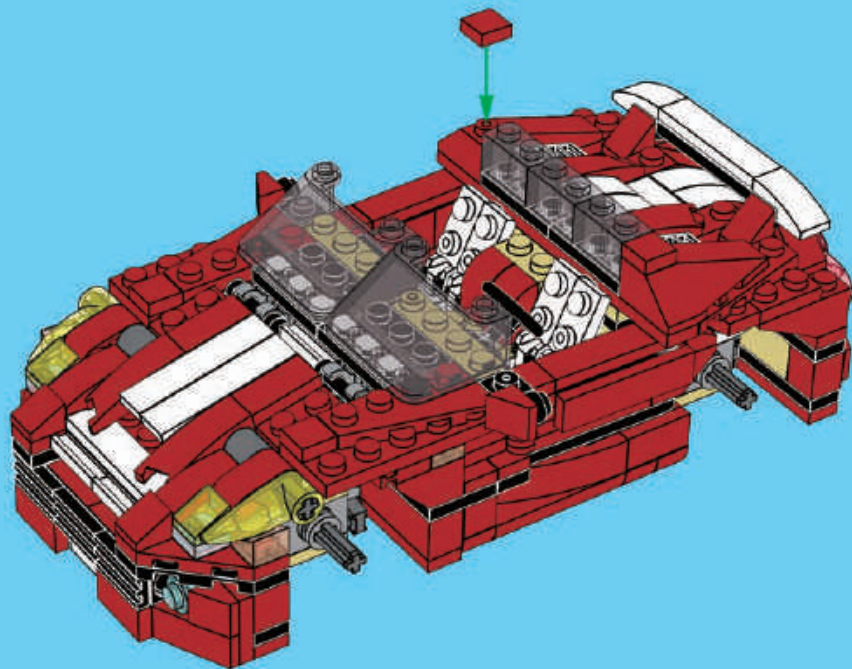



1x

54

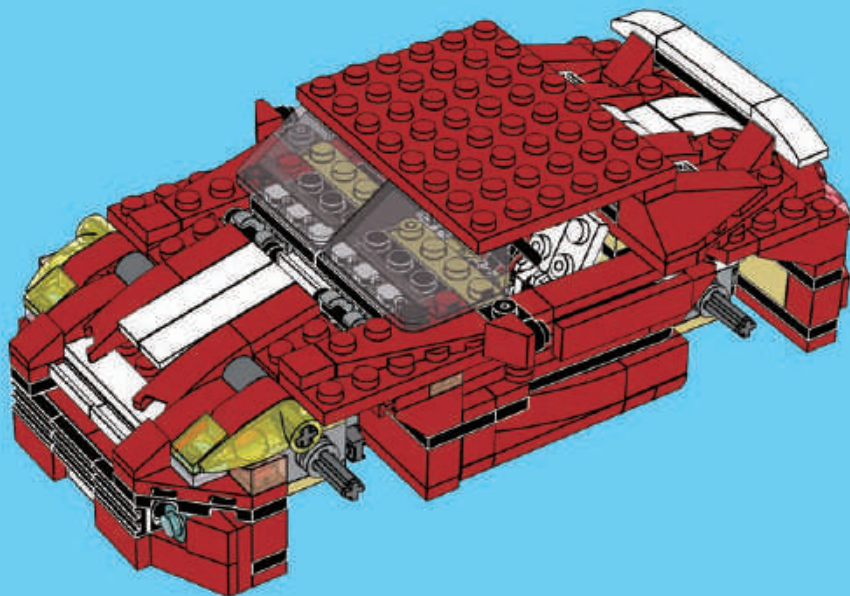



4x



4x

55

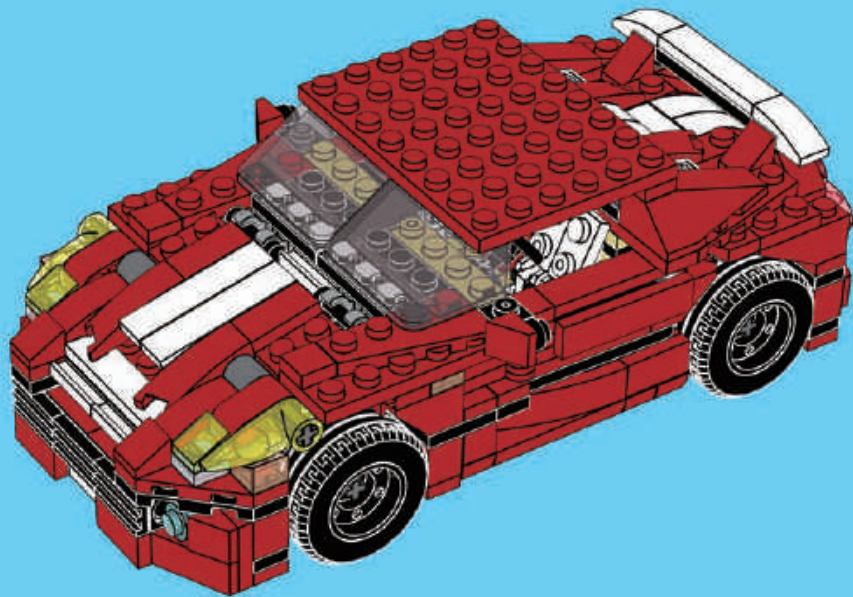



4x



2x

56

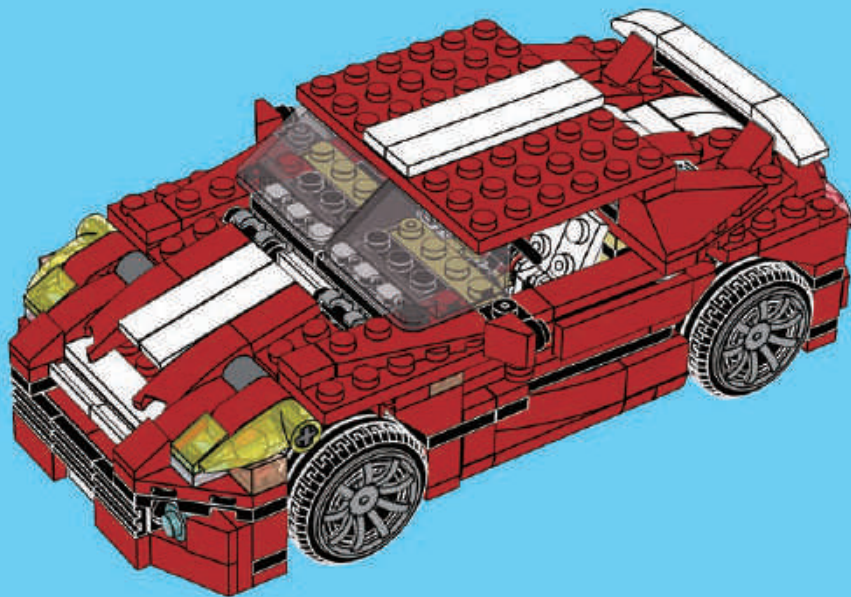



1x



1x

1



2x

2

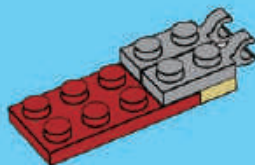

1x



1x

3

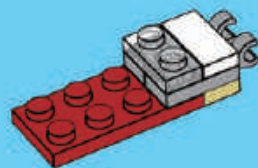

2x

4

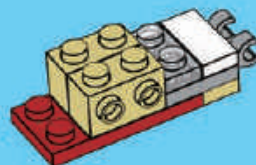

1x



2x

5

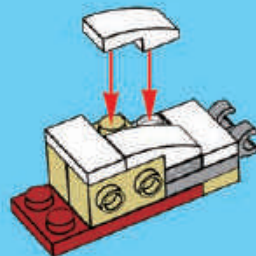



6

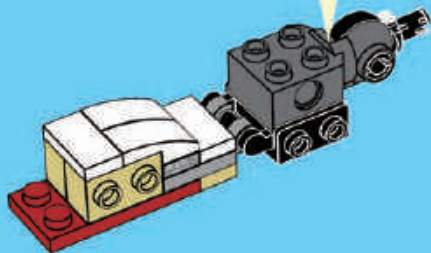
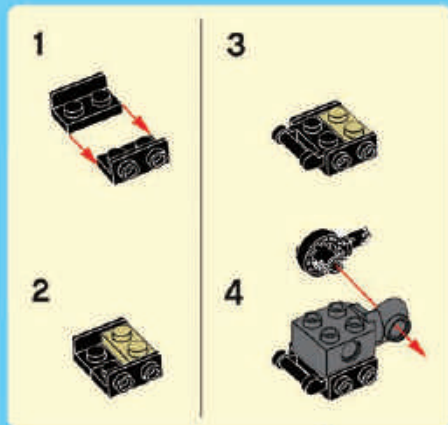

7

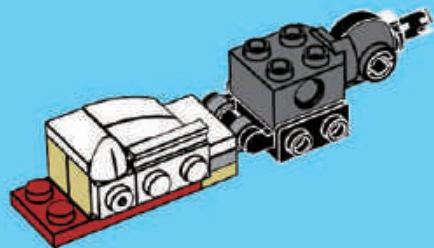

8

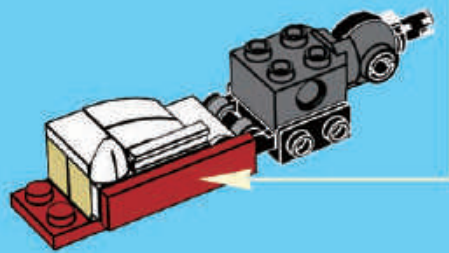



1x



1x

9

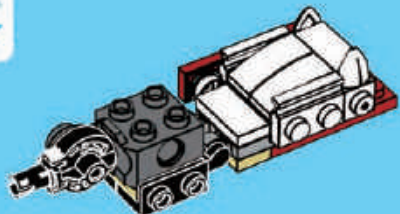

1x



1x

10

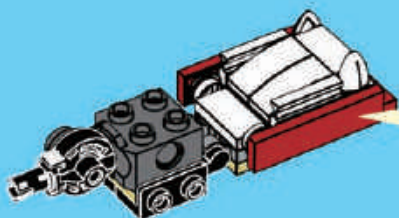
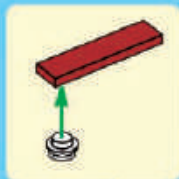

2x

11

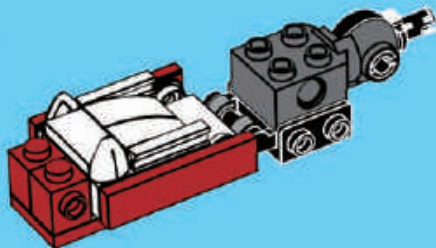

1x



2x

12

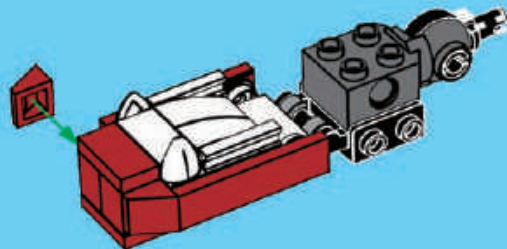



1x

13

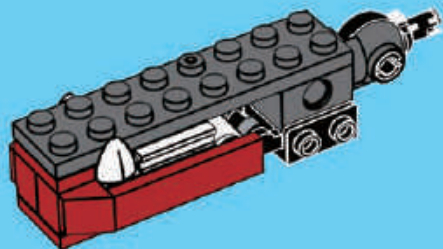

1x



2x

14

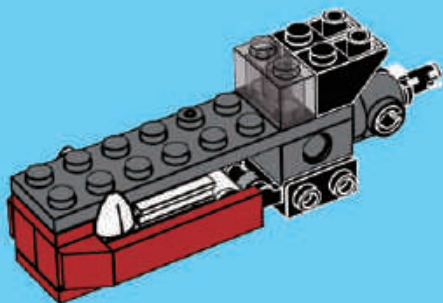

2x

15

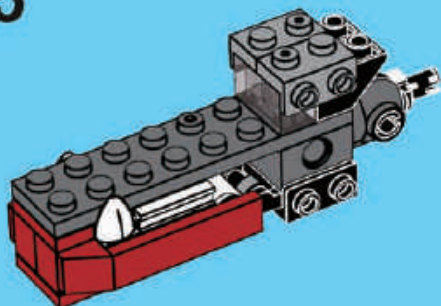

2x



1x

16

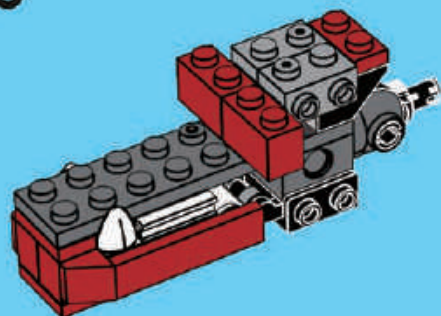



17

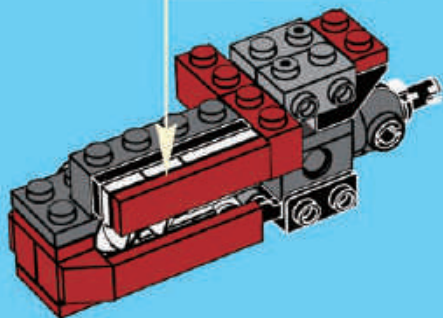

18

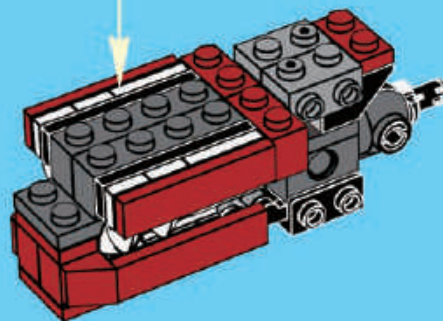
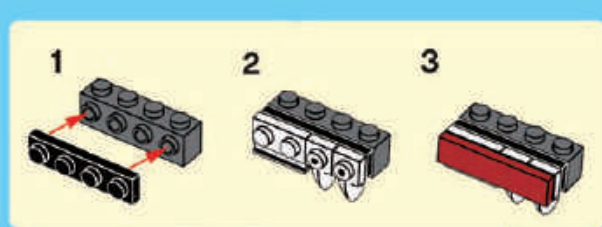



1x

19

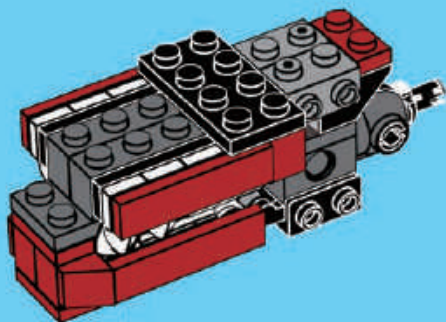

1x



1x



1x

20

1

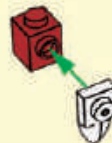

2

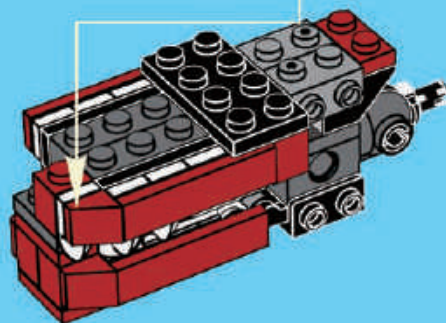



1x



1x



1x

21

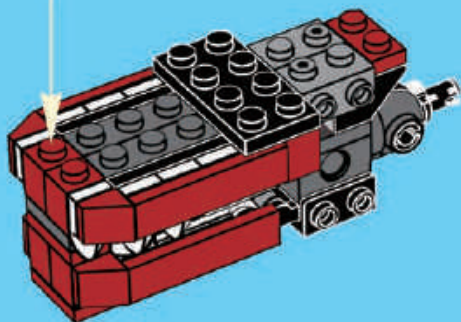
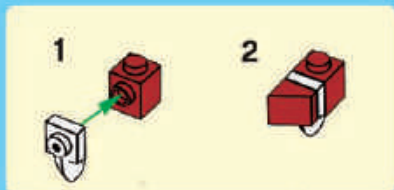

1x



1x



1x

22

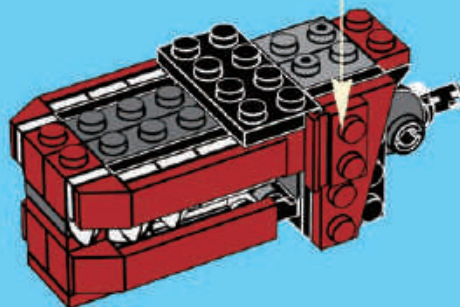



23

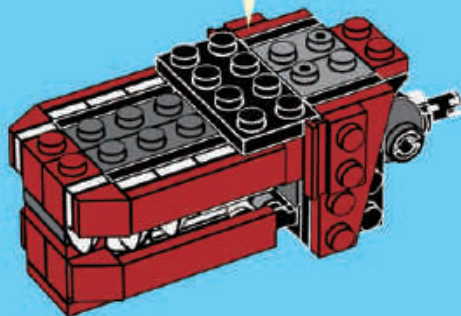

24

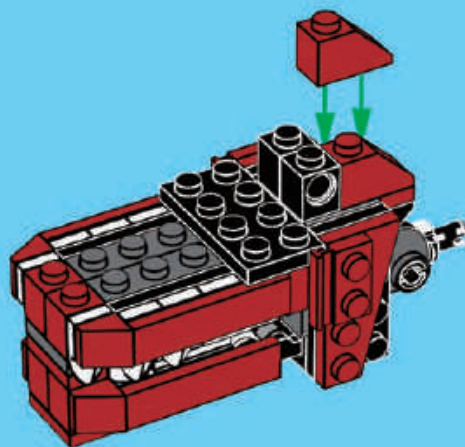

4x



1x

25

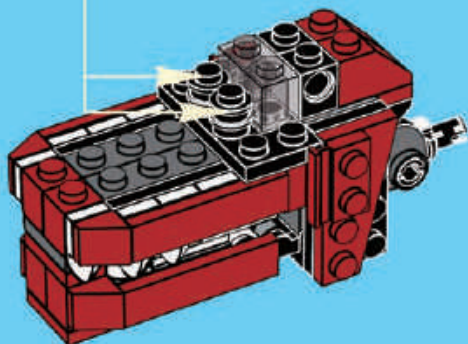

1x



1x

26

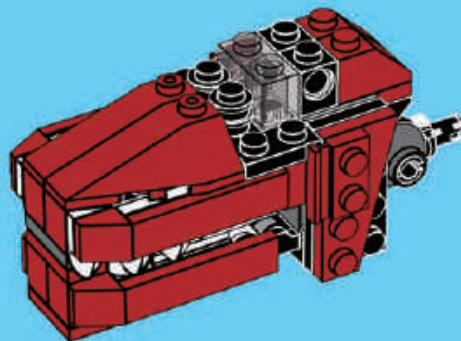



2x



2x



2x

27

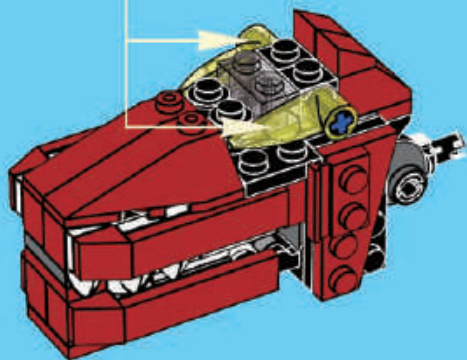

1x

28

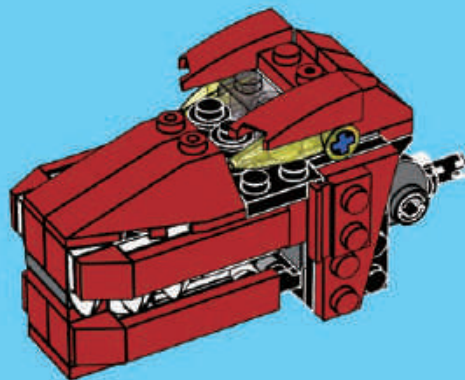



2x

29

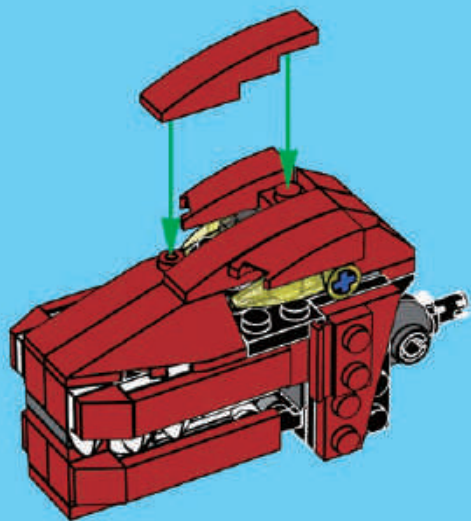

2x

1

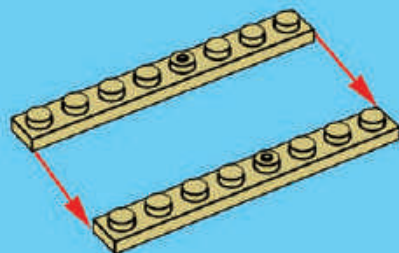

1x

2

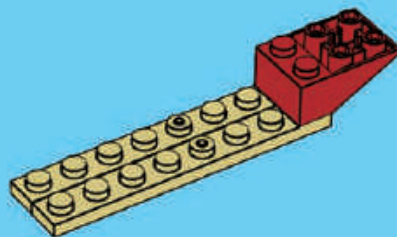



2x

3

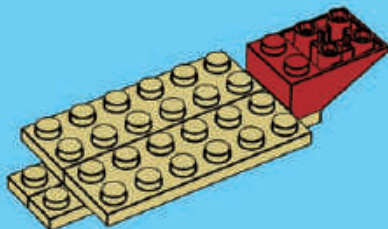

1x



2x

4

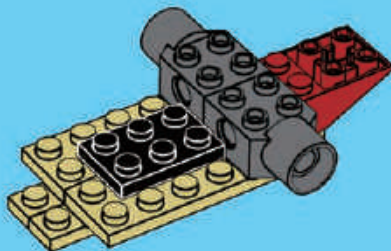

2x



2x

5

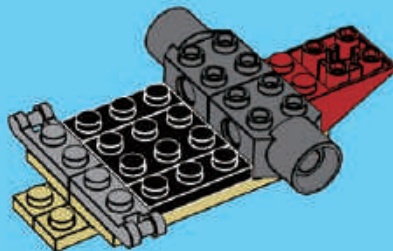

2x



2x

6

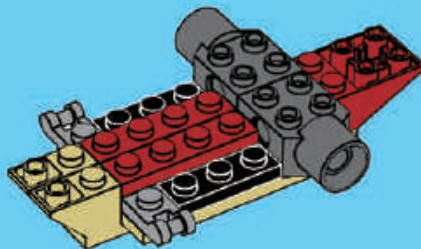



7

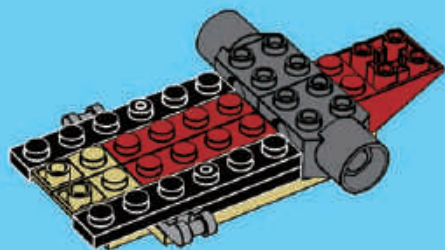

8

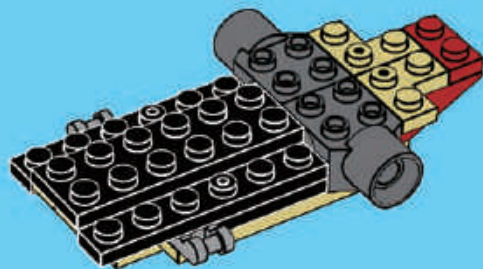

9

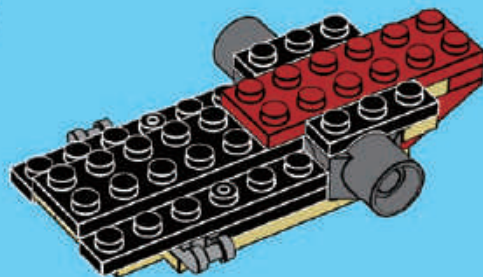

10

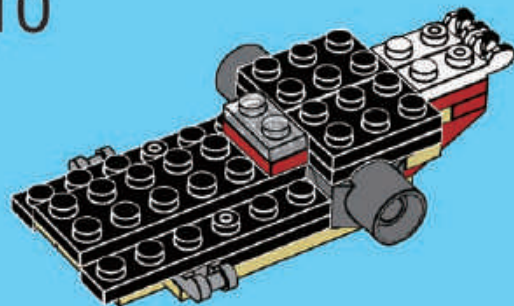



11

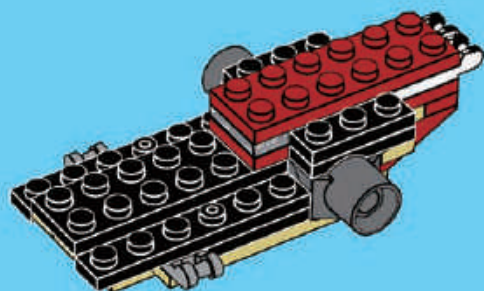

12

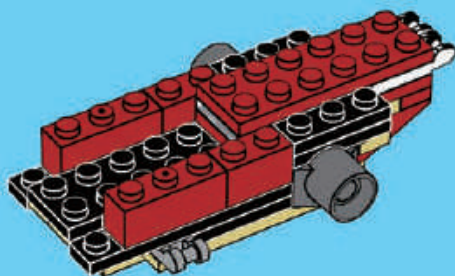



13

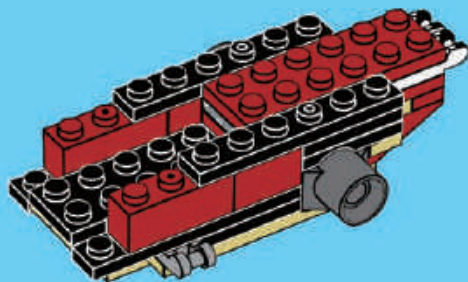

14

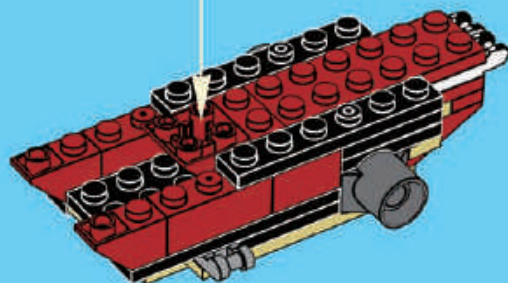



15

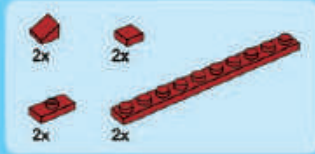
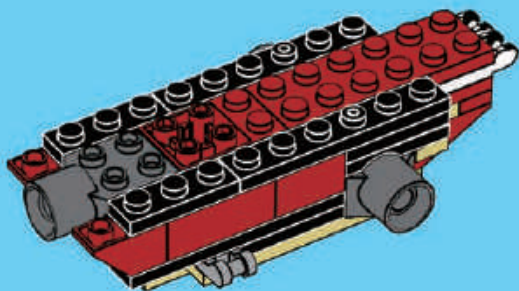

16

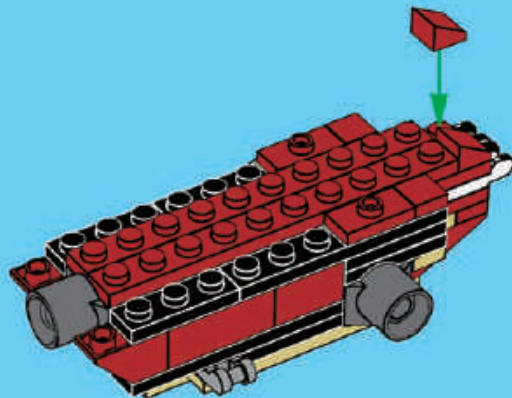



17

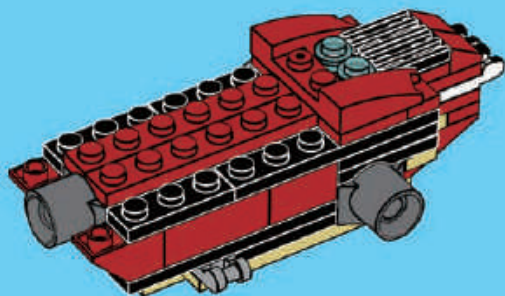

18

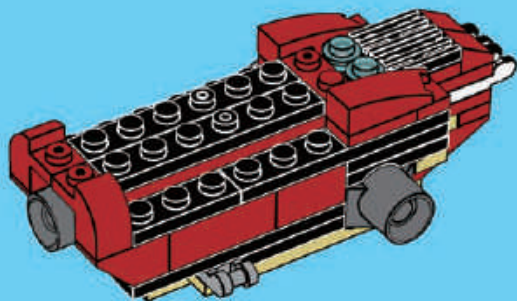



2x



4x

19

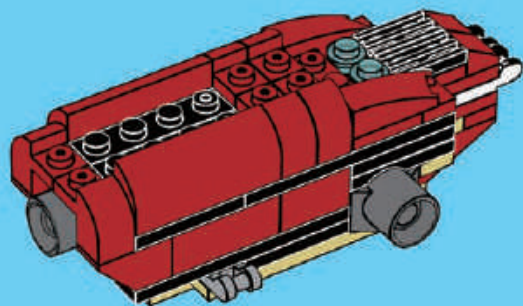

2x



1x

20

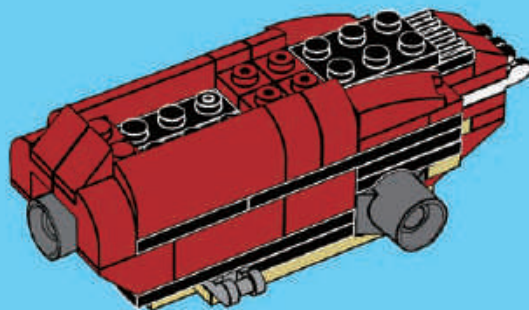



2x



2x

21

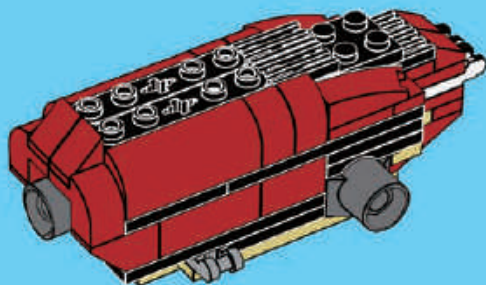

1x

22

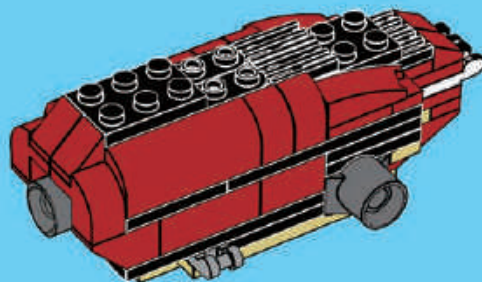



1



2



3

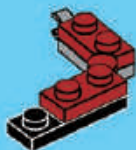

4



5



6

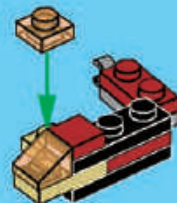

23

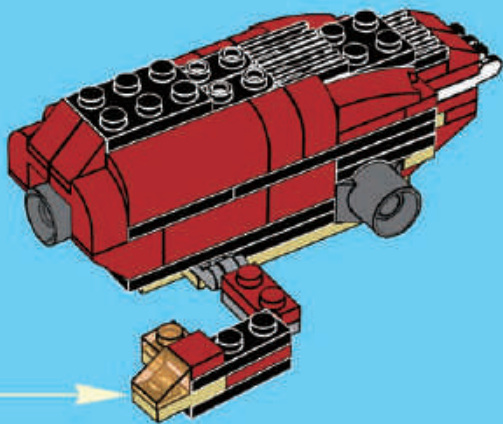

1



2

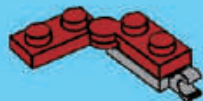

3





1x

4



1x

5



1x



1x



1x

6



24

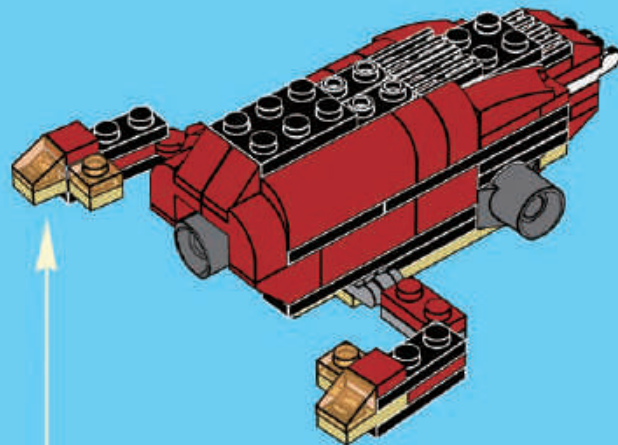

30

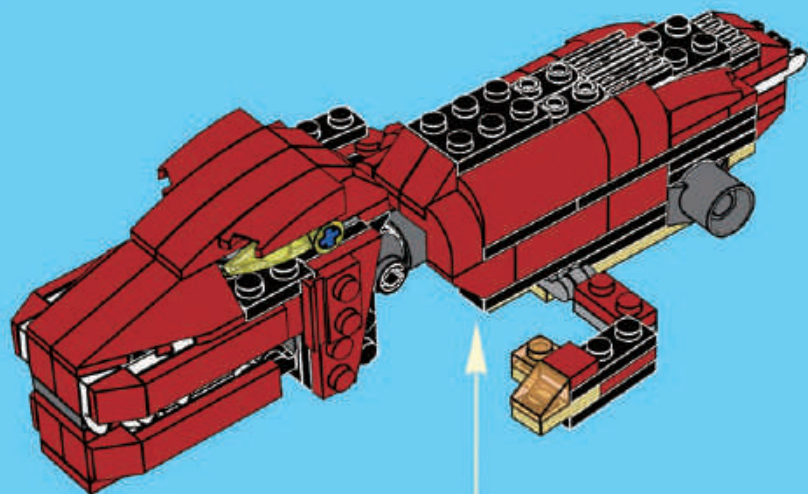



1



2



3



4

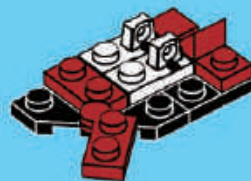



2x

5



2x

6

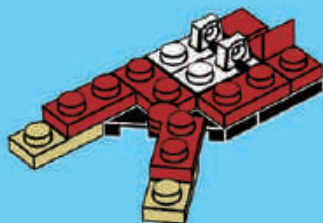

2x

7



1x



1x

8

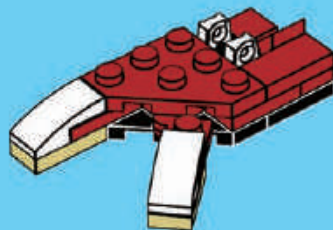



1

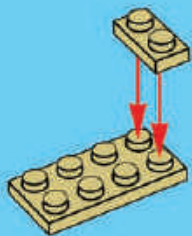

2

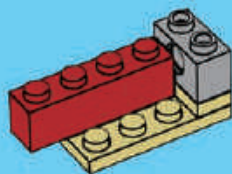

3

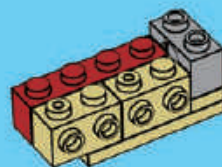

4

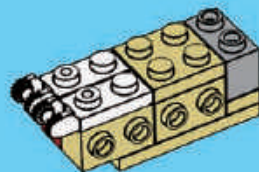



1x

5



1x



1x

6

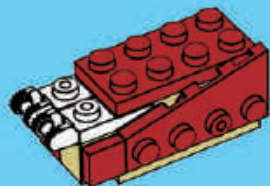

1x



1x



1x

7

1



2

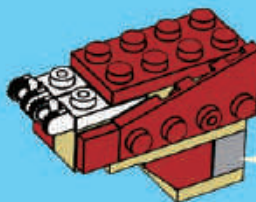

9

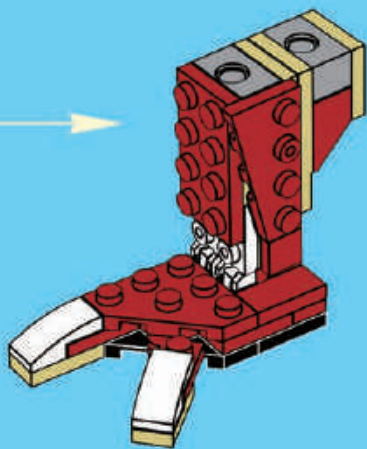

1x



1x

1

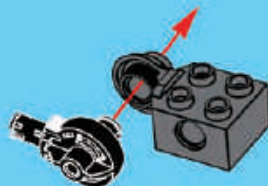

1x

2

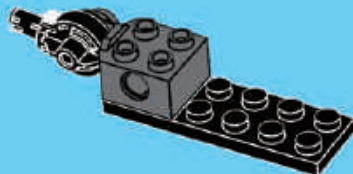



1x



2x

3

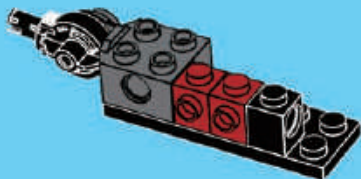

2x



2x



1x

4

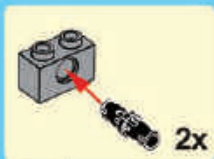

2x

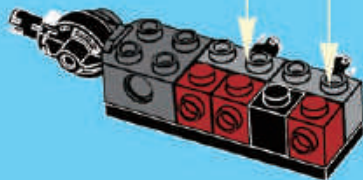

1x

5



1x



1x

6

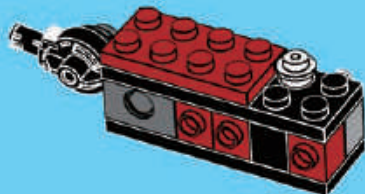

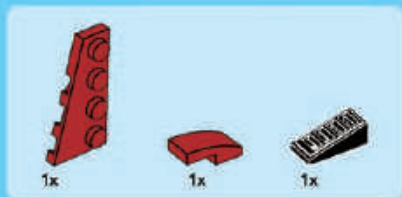

7

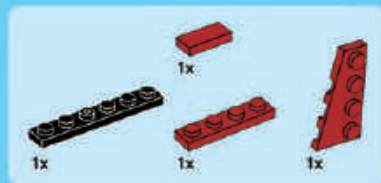

8

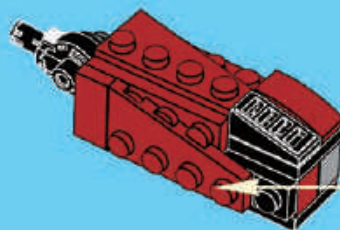
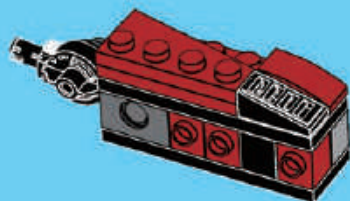
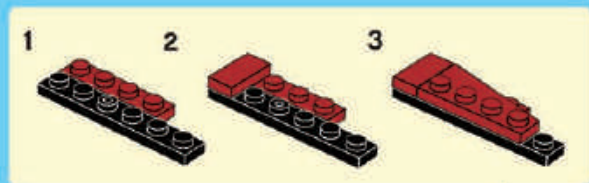

10

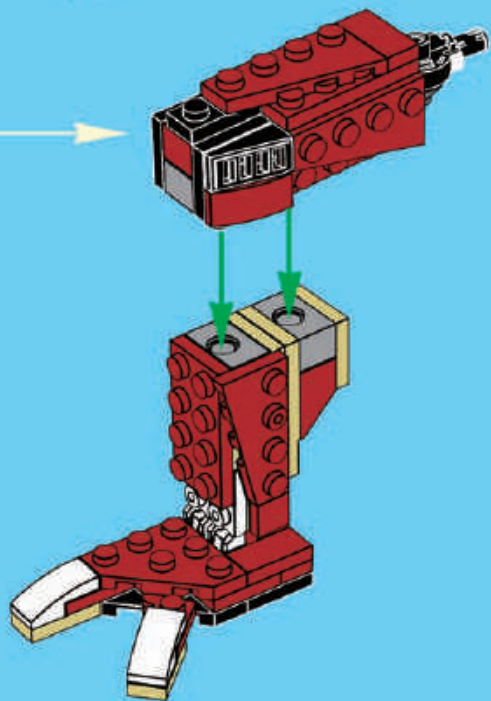

31

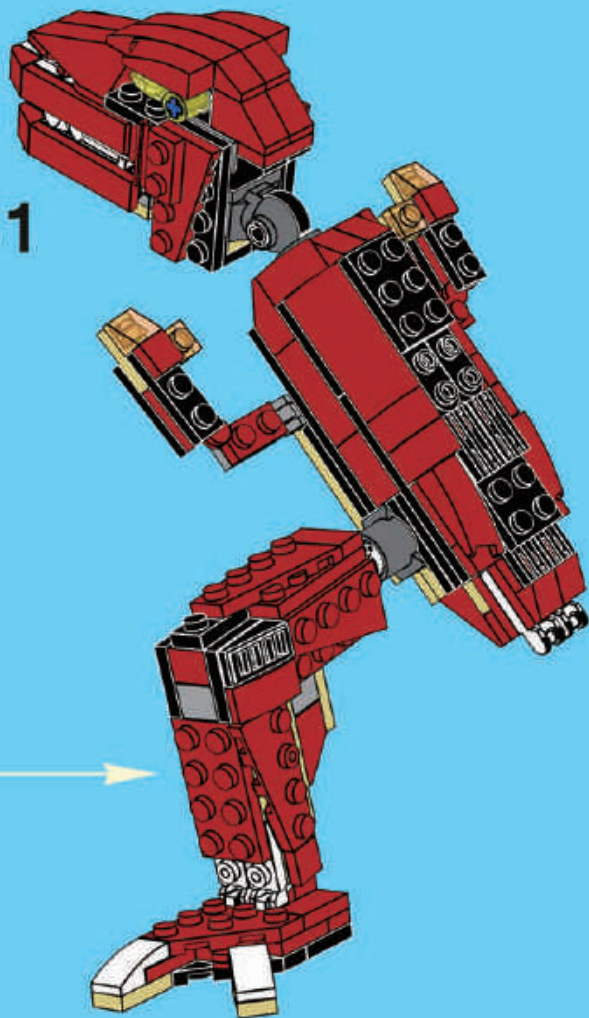



1x



1x

1



1x



2x

2



1x

3



1x

4

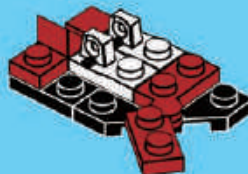



2x

5



2x

6

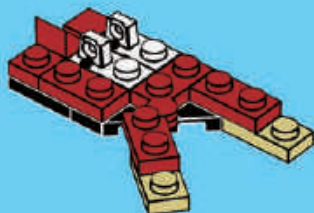

2x

7

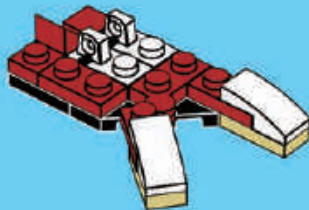

1x



1x

8

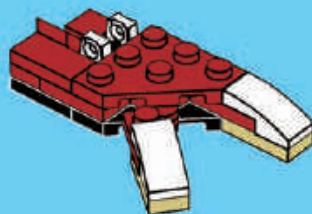



1x

1x

1

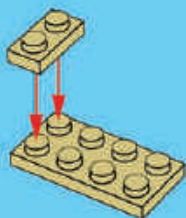

1x

1x

2

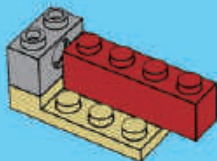

2x

3

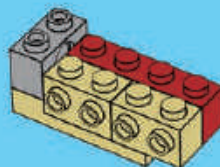

1x

2x

4

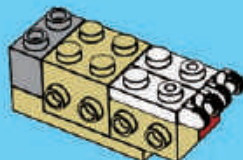



1x

5

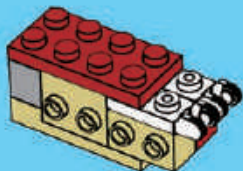

1x



1x

6



1x



1x



1x

7

1



2

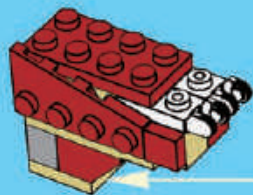

9

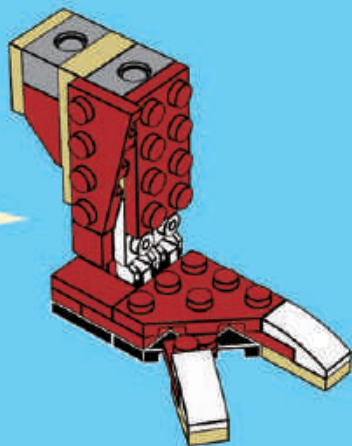

1x



1x

1

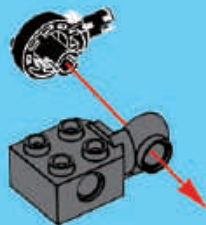

1x

2

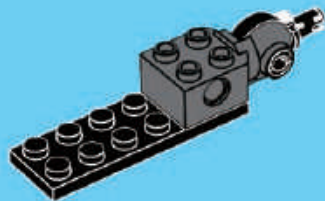



1x



2x

3

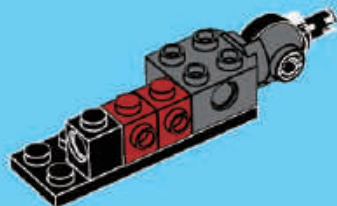

2x



2x



1x

4



2x

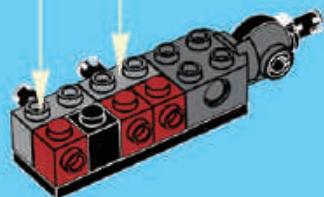

1x

5

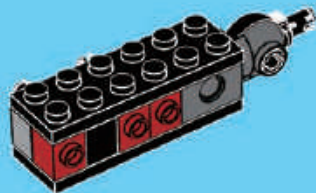

1x



1x

6

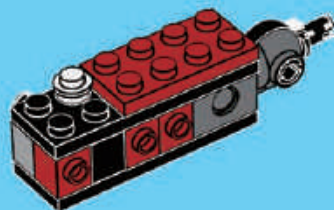



7

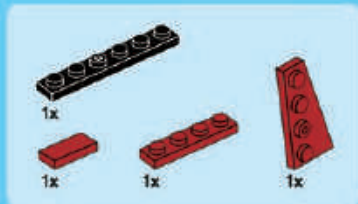

8

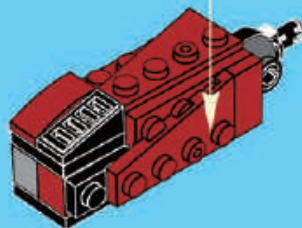
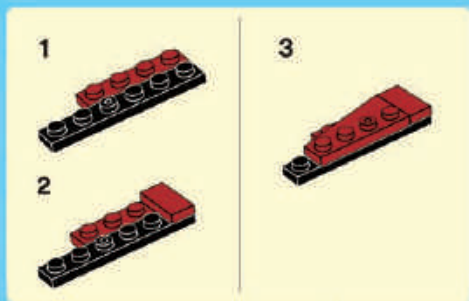
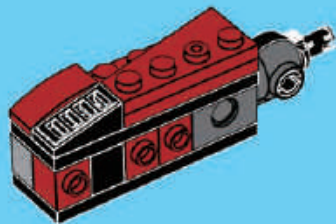

10

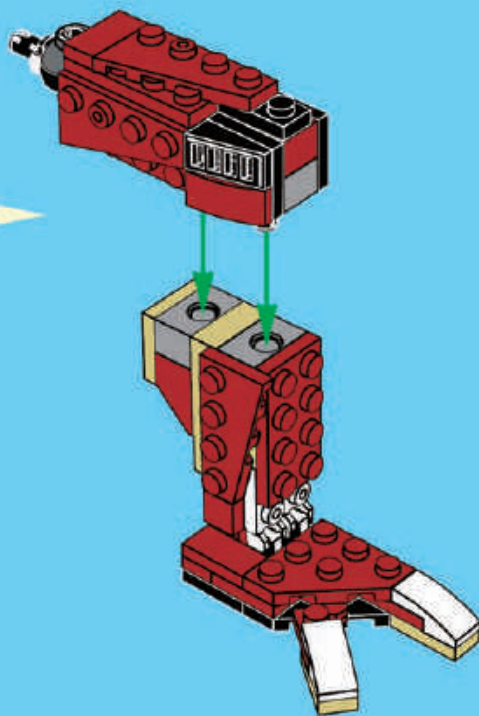

32

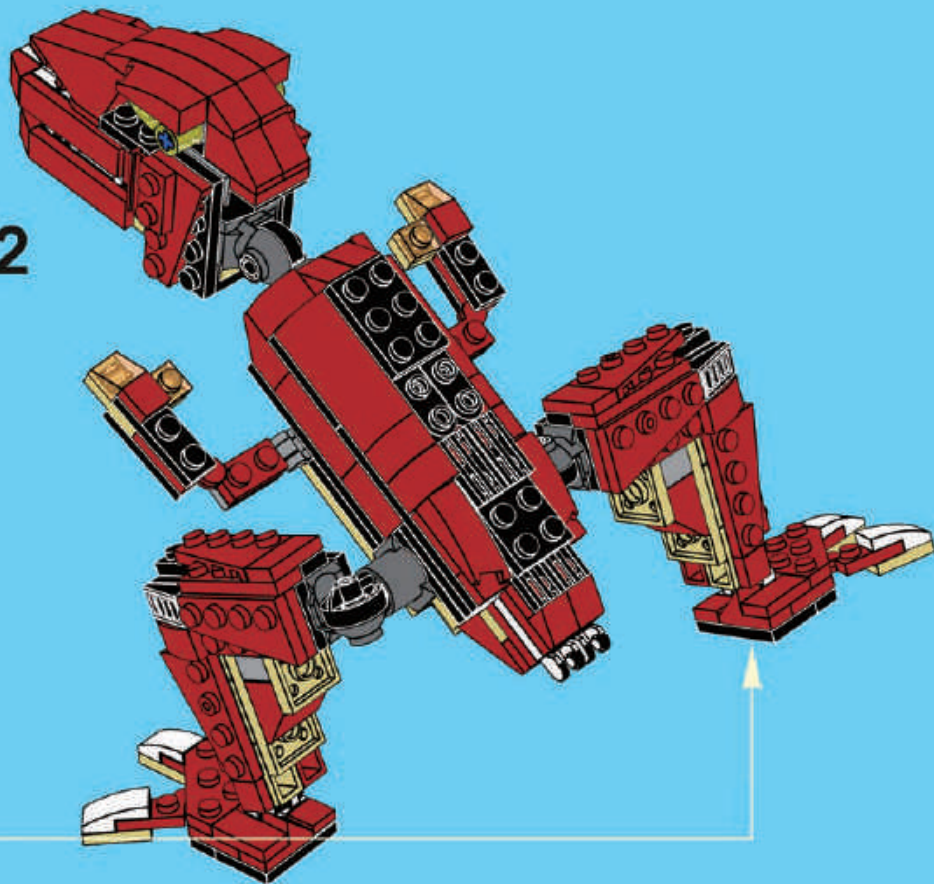



1x



1x

1

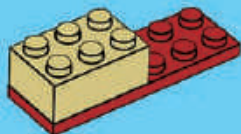

2x

2

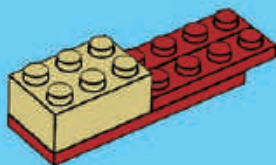

2x



2x

3

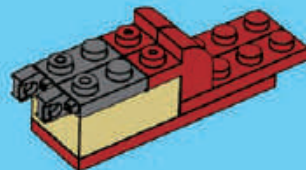

1x



1x

4

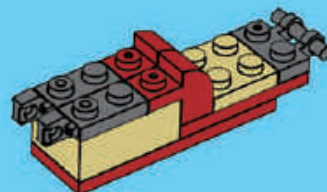



5

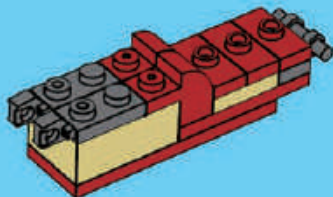

6

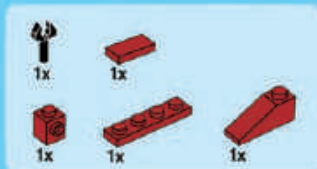
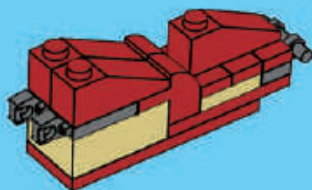

7

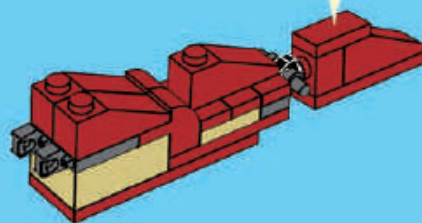

33

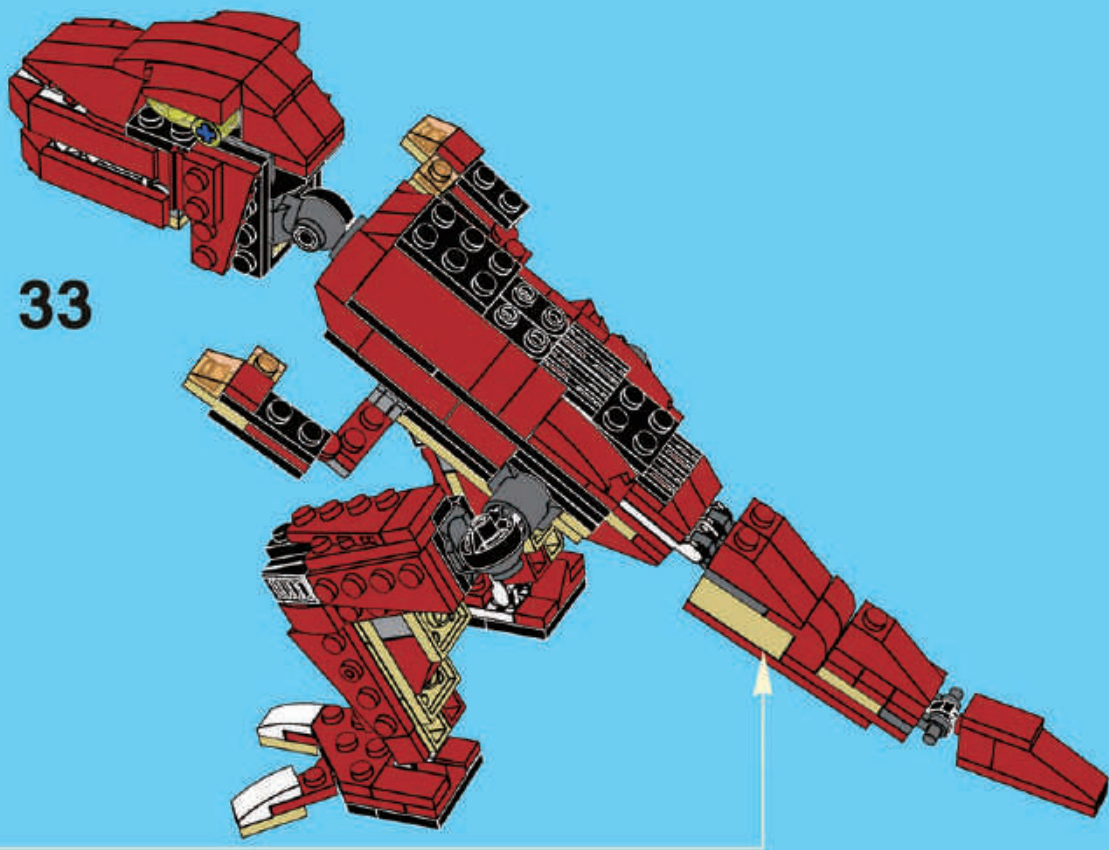

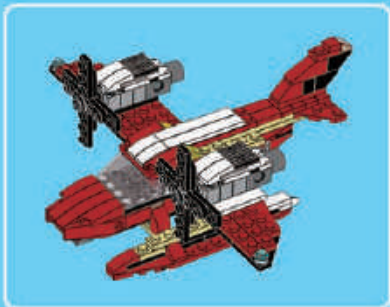

1

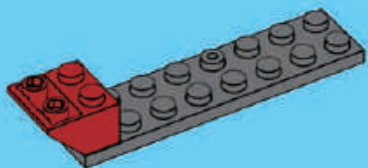

2



3

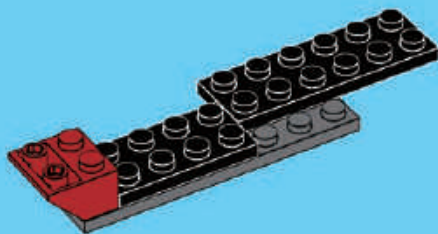



1x

4

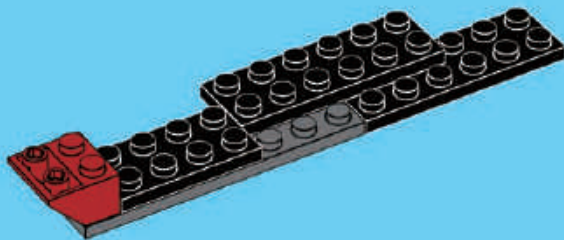

1x



1x

5

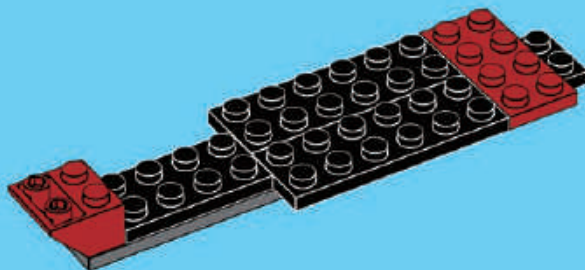



1x



1x

6

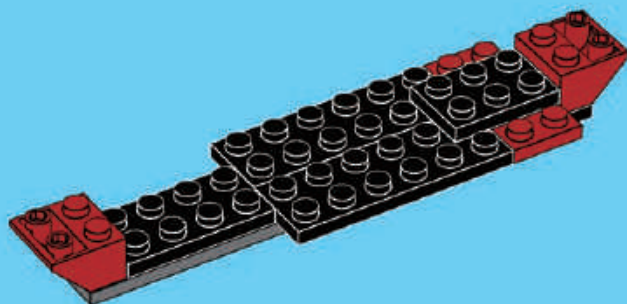

4x

7

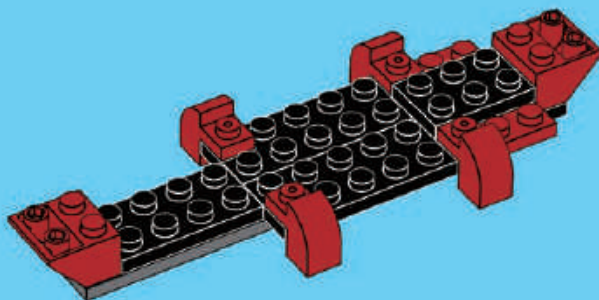



2x



2x



1x

8

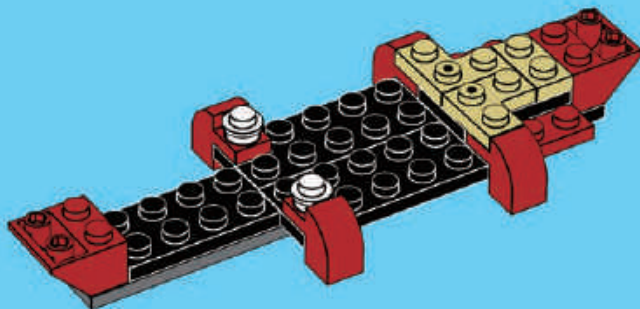

2x



2x

9

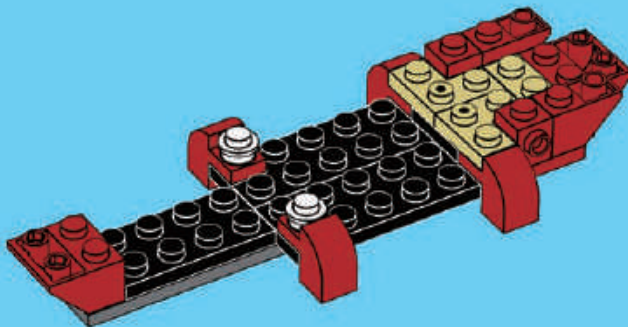



2x



2x

10

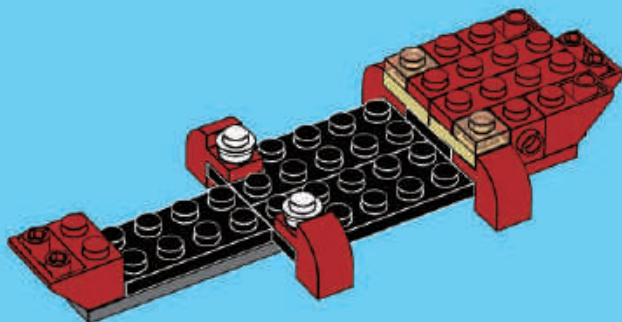

2x



2x



2x



2x

11

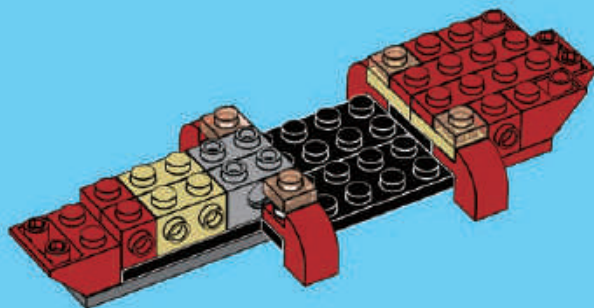



2x

12

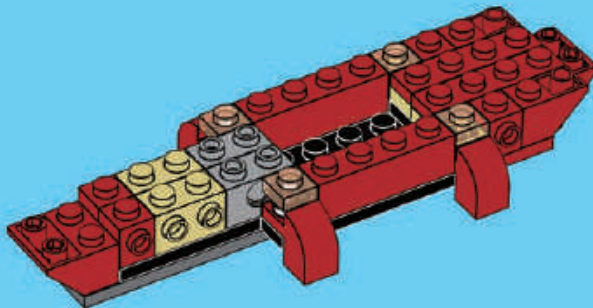

2x



2x



4x

13

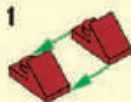

1



2



3

2x

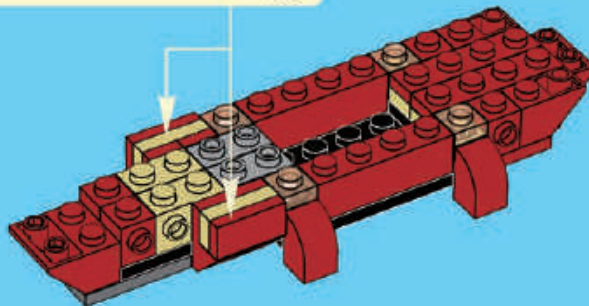

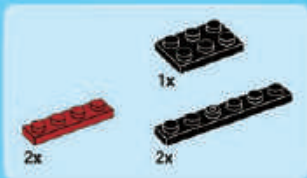

14

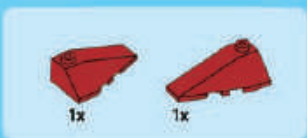
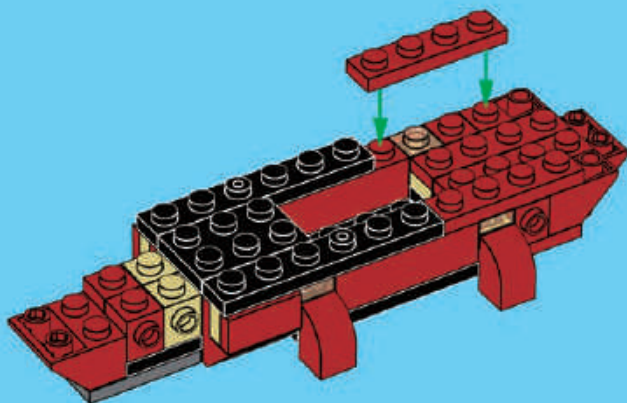

15

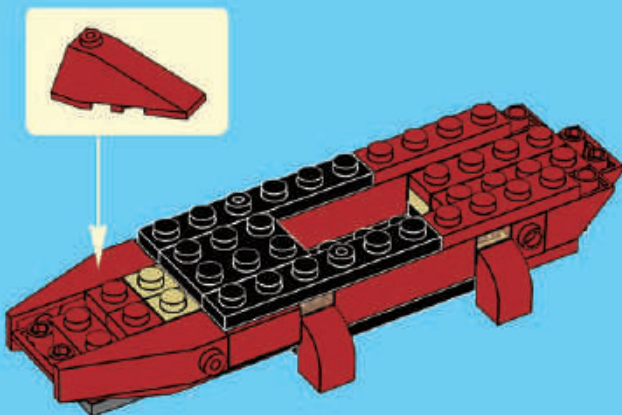



16

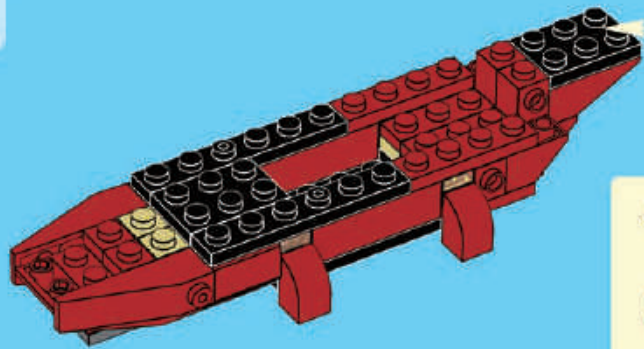

17

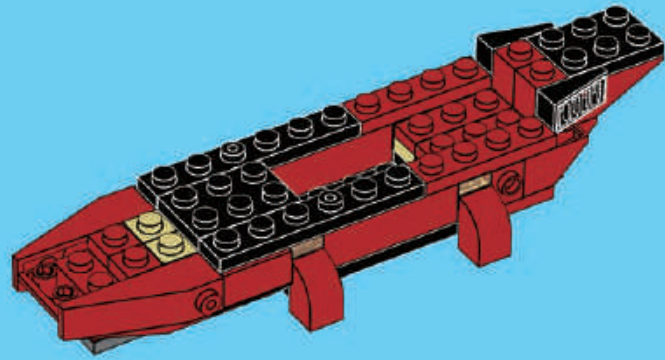

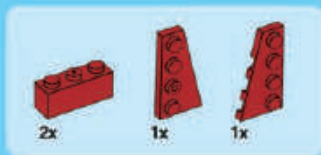

18

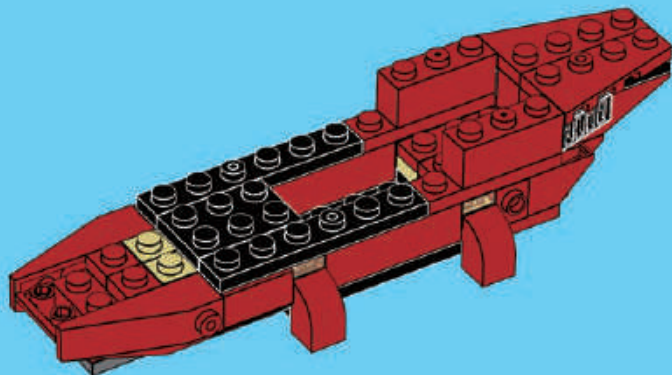



2x

19

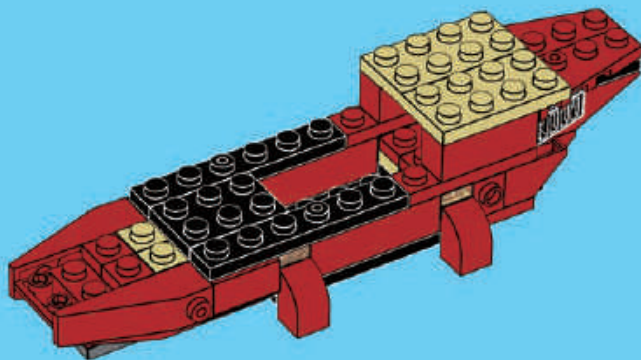



20

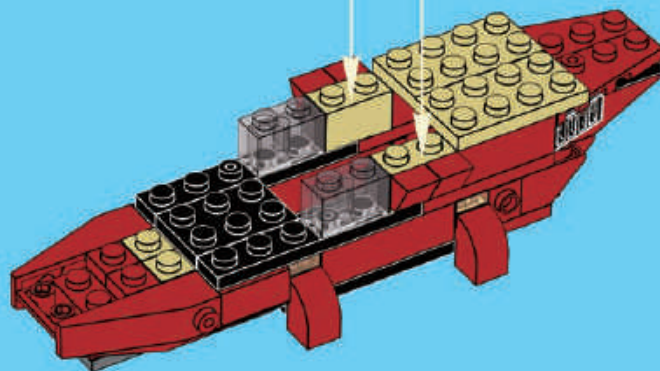
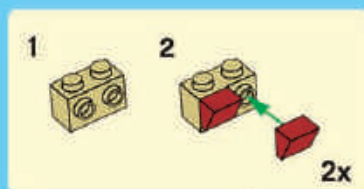



1x

21

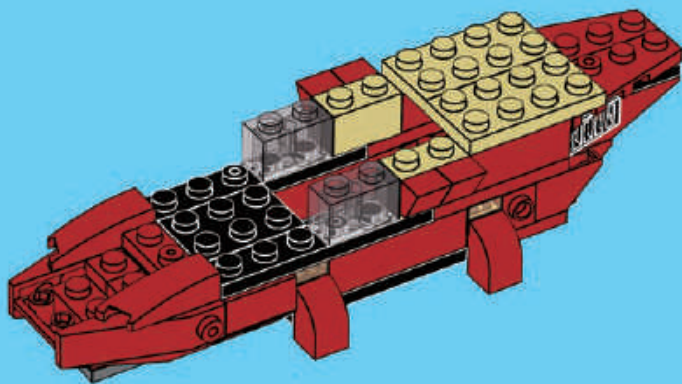



2x

22

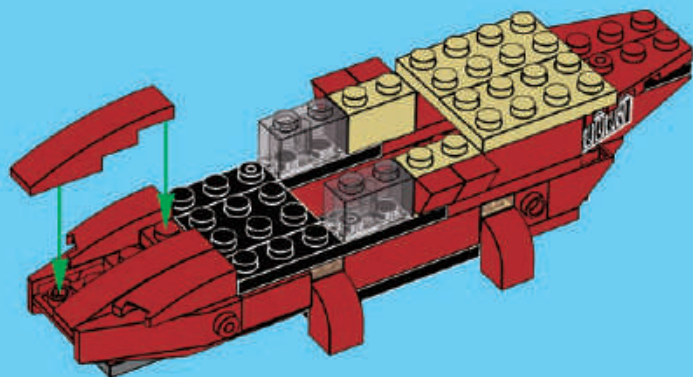



1x



1x

1

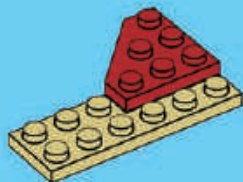

1x

2



1x

3

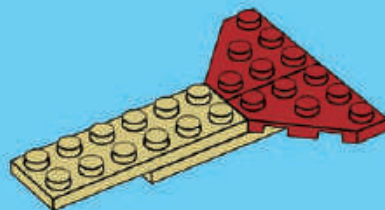

2x



4x

4

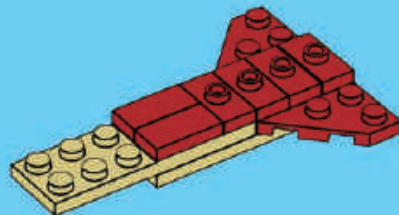



1x

5

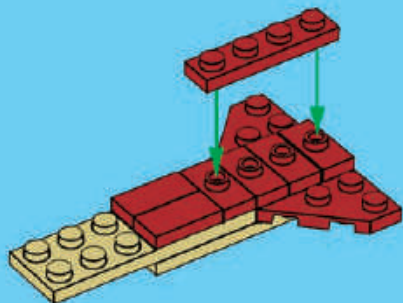

1x



1x



1x

6

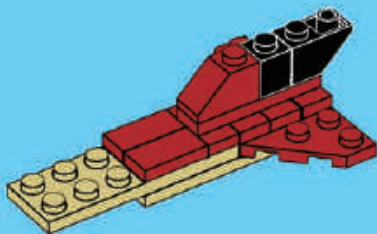

1x



1x

7

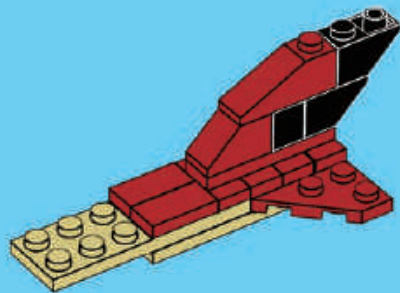



1x

8

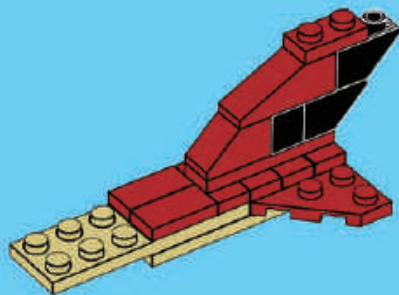

1x



1x

9

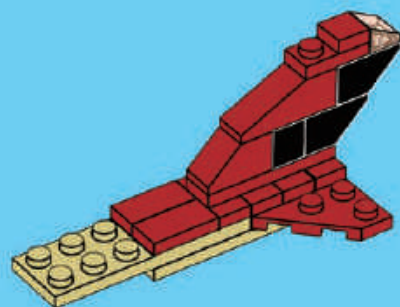

23

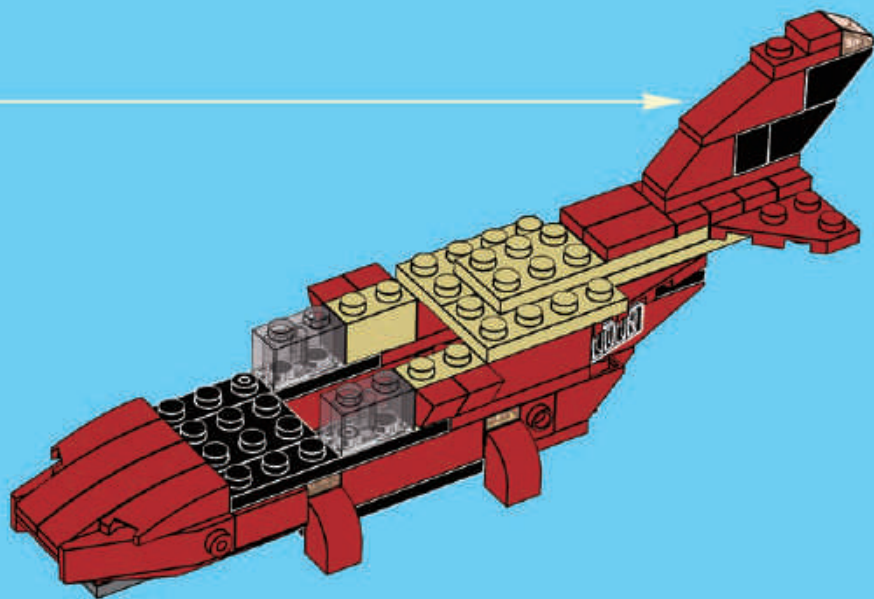



1

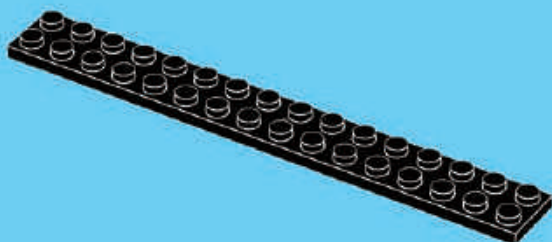

2

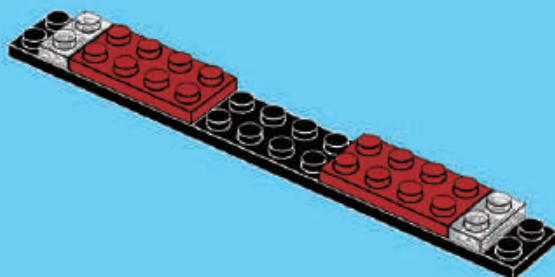



1x

3

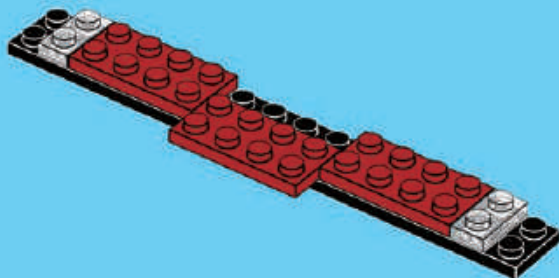

1x

4

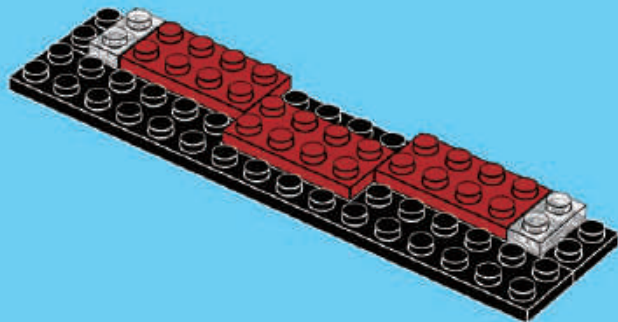



5

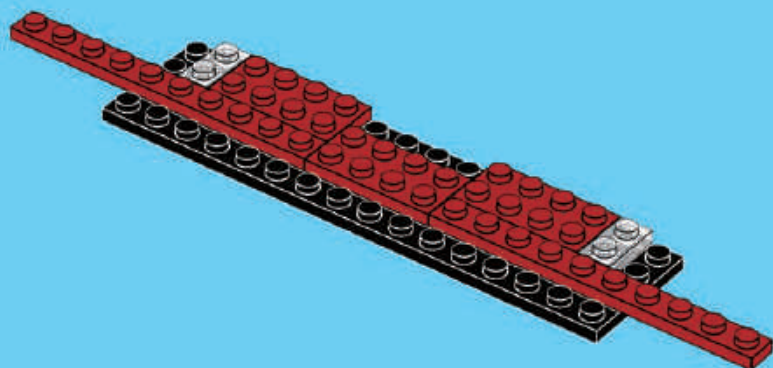



2x

6

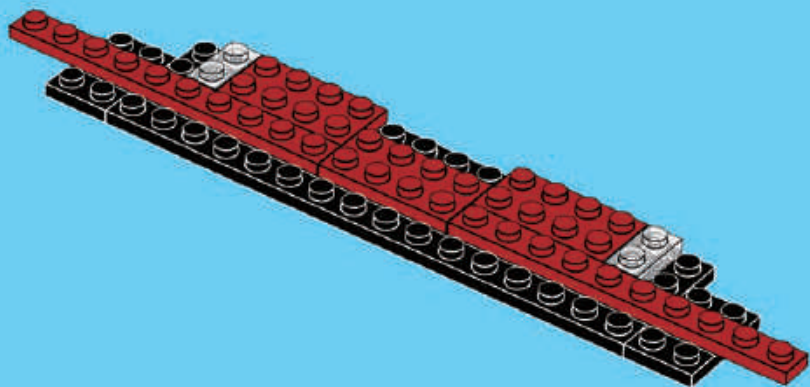



2x

7

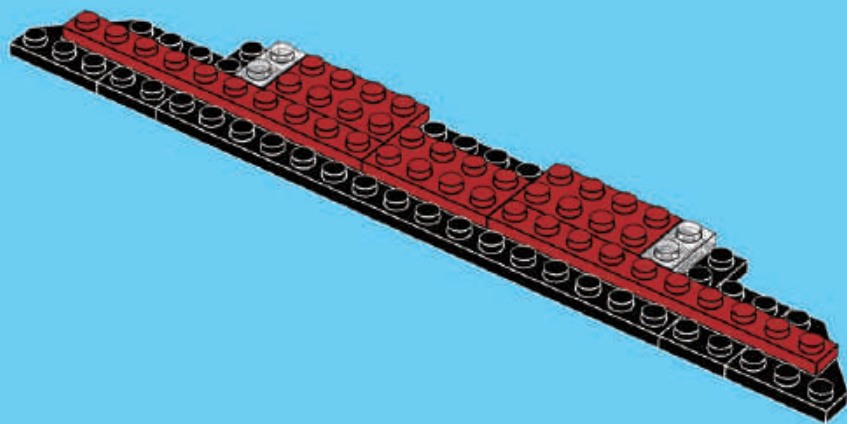



1x



1x

8

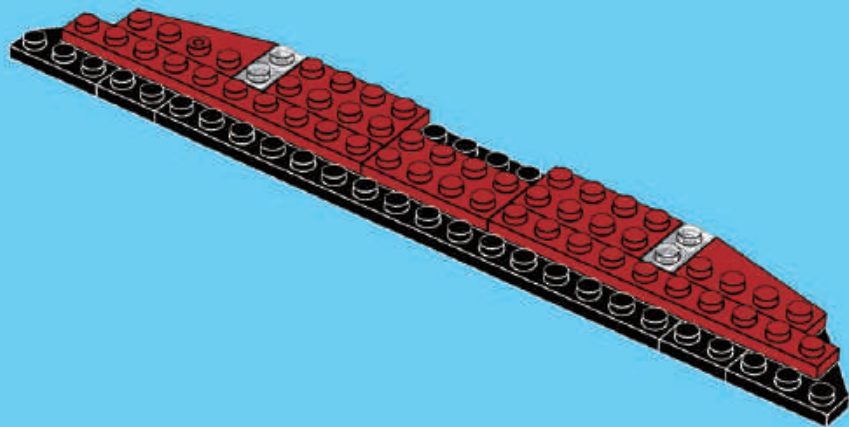



9

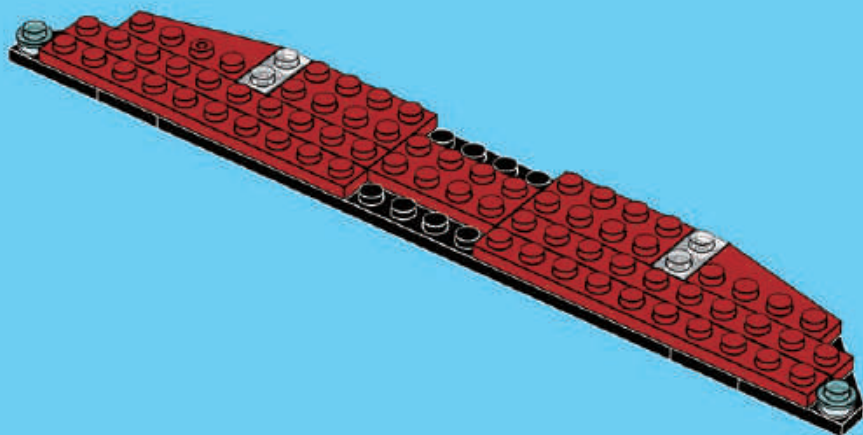



2x

10

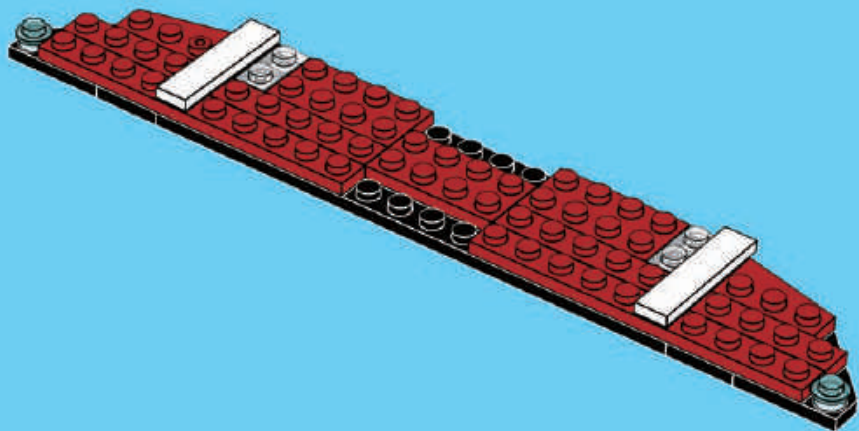

24

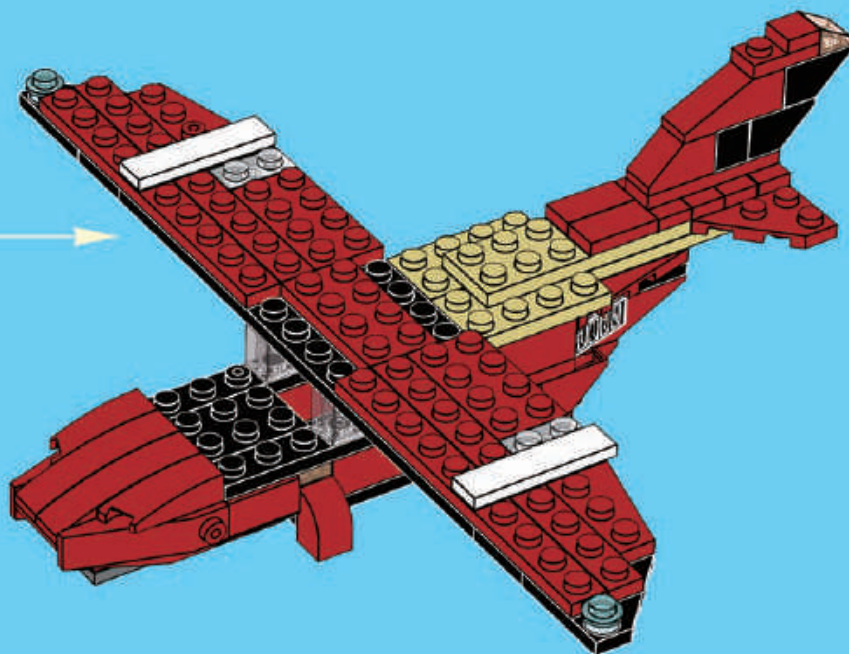



1x

25

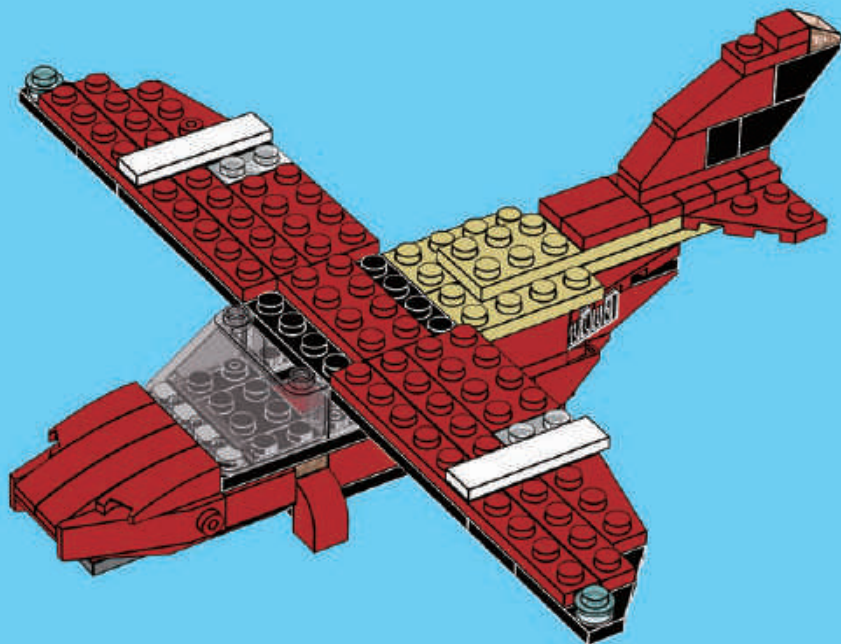



1x



2x

26

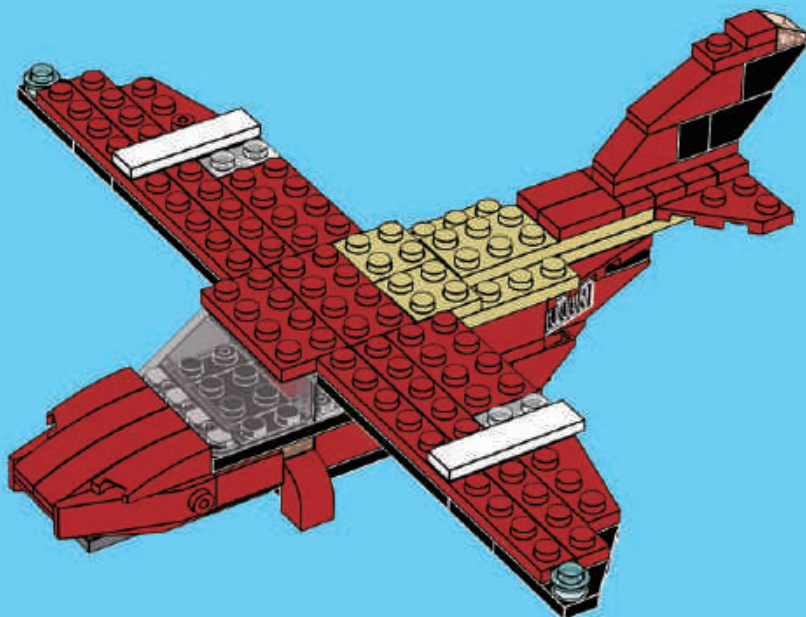



27

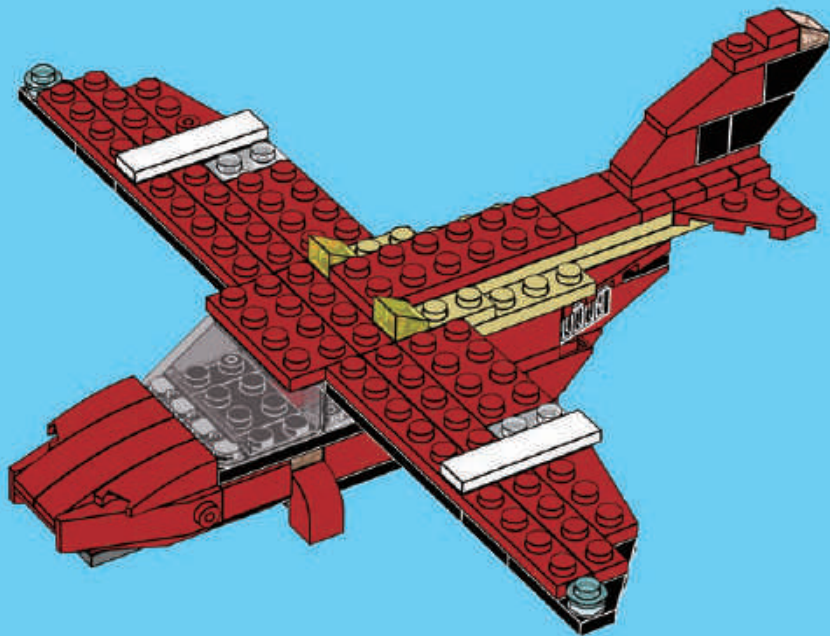



1x



1x

28

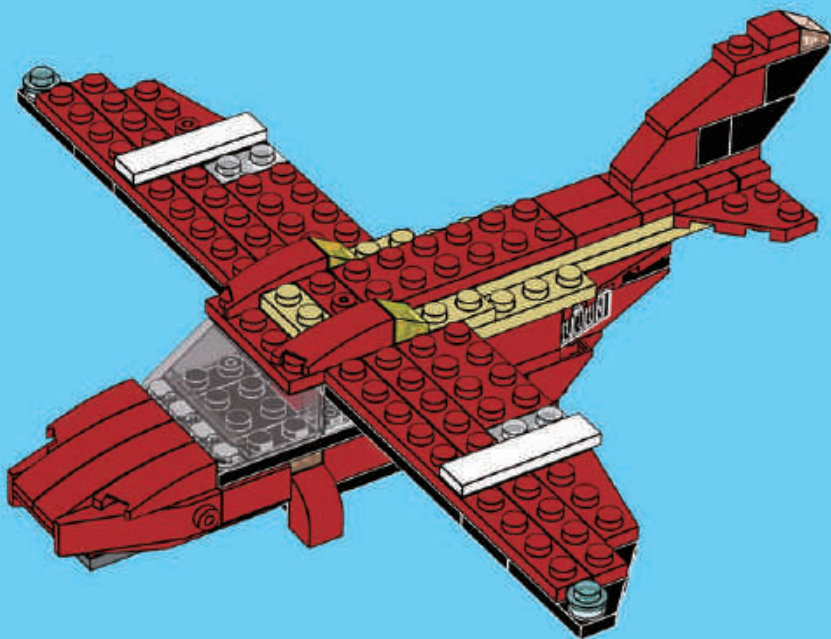

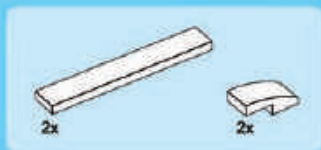

29

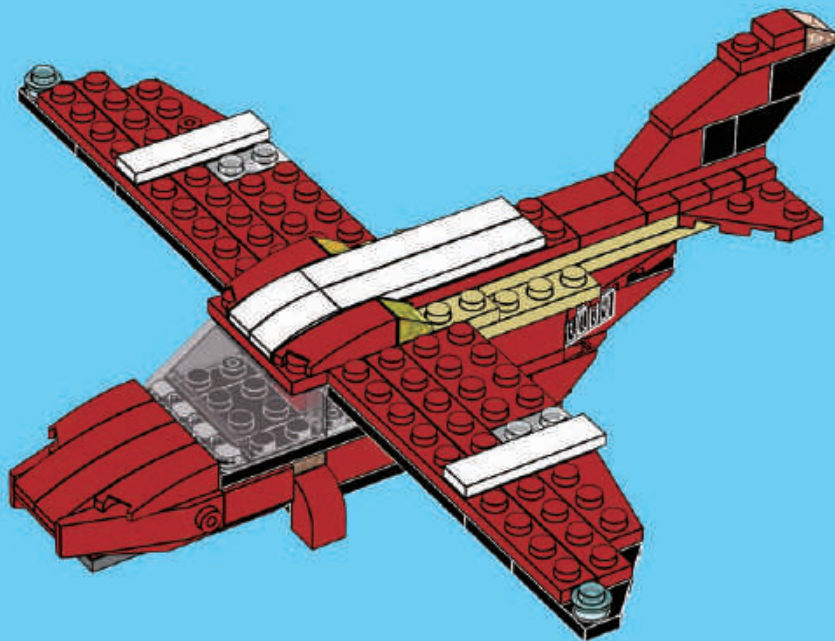



1x



1x

1



1x

2



1x

3

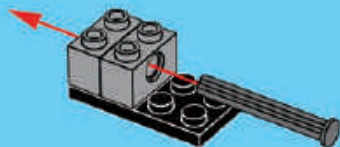

1x

4

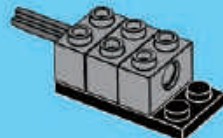

1x



1x

5

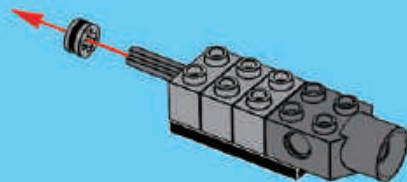

2x



1x

6

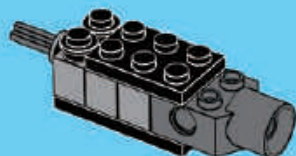

1x

7

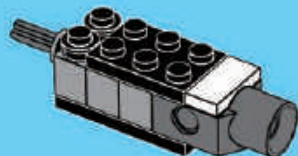

2x



2x

8

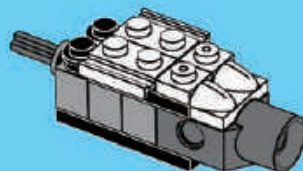

2x



2x

9

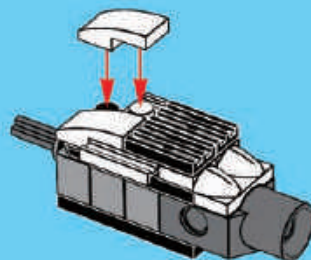

2x

30

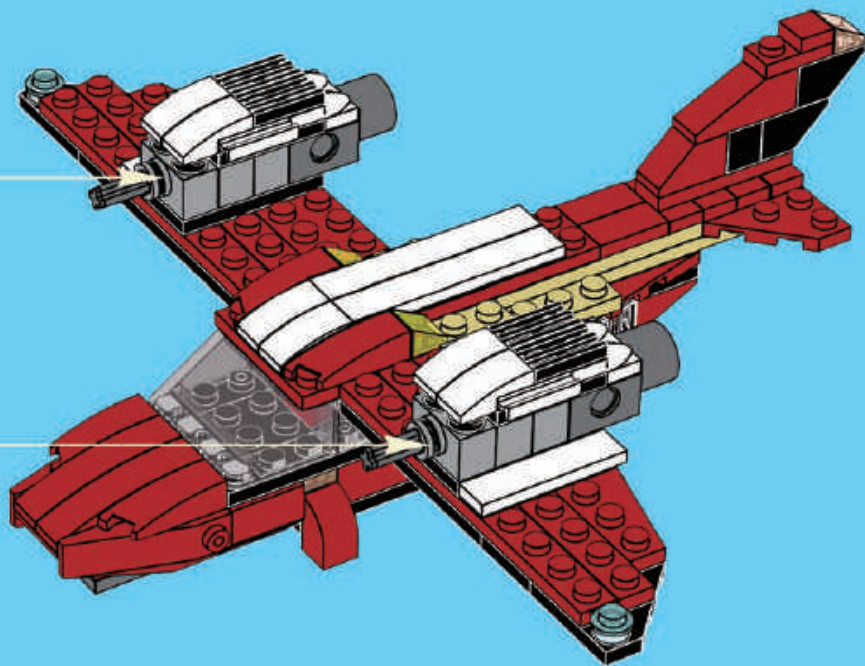



1

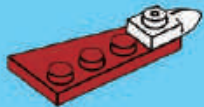

2



3

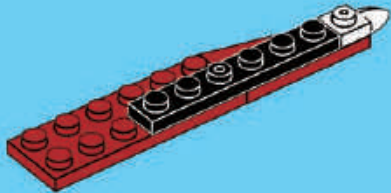

4

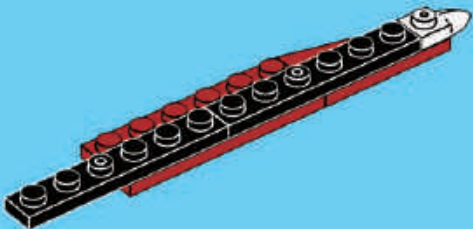



5

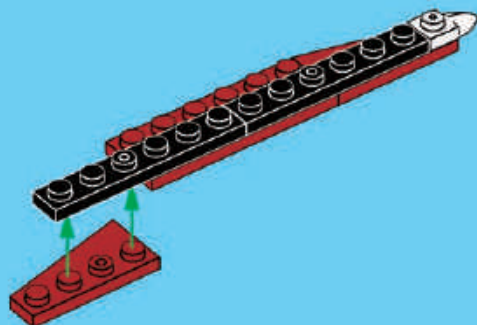

6

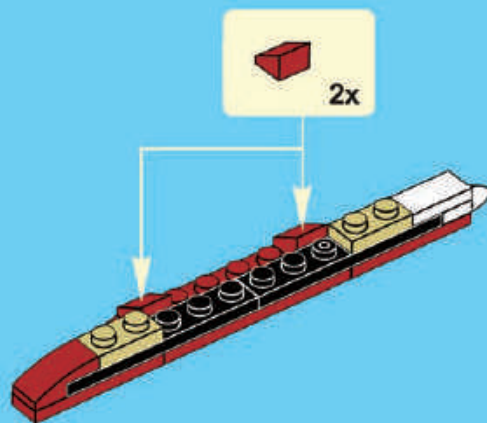



7

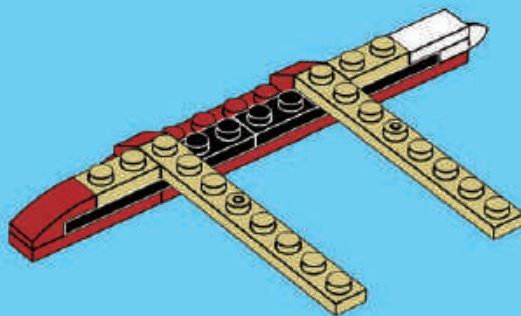



1

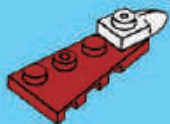

2

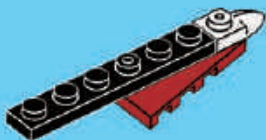

3

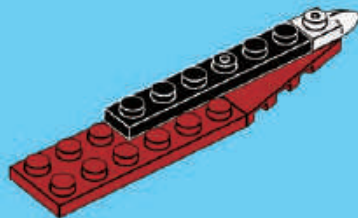

4

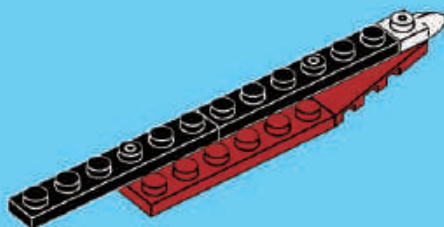



1x

5

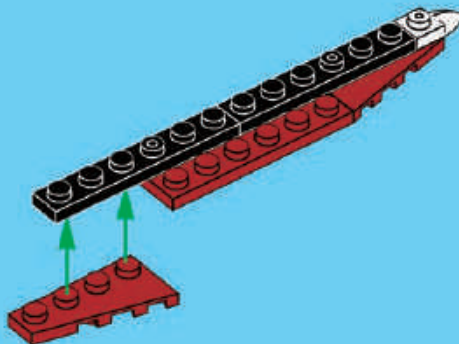

1x



2x



2x



1x

6

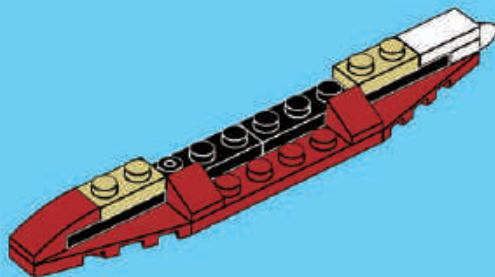

8

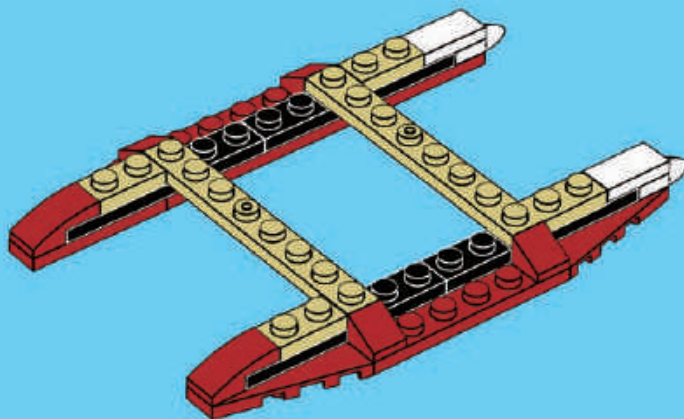



2x

9

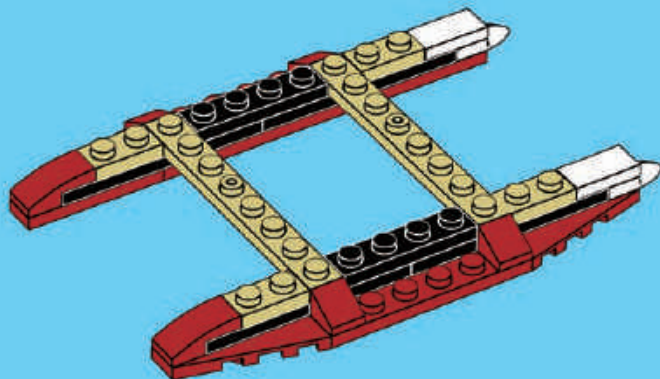



2x

10

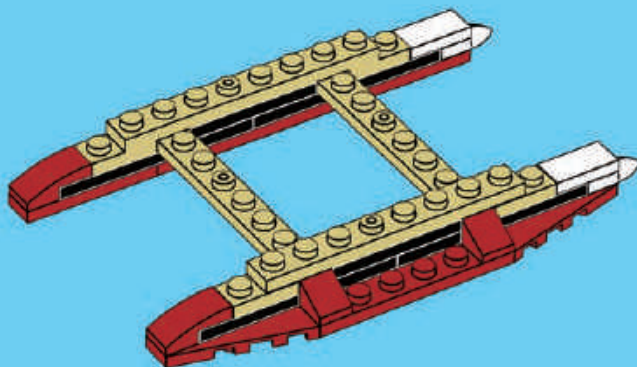



4x

11

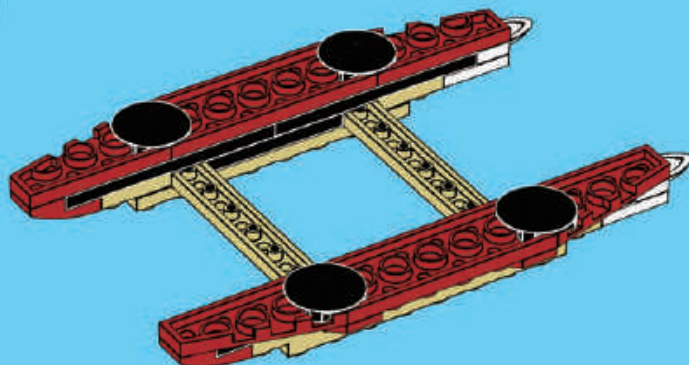

31

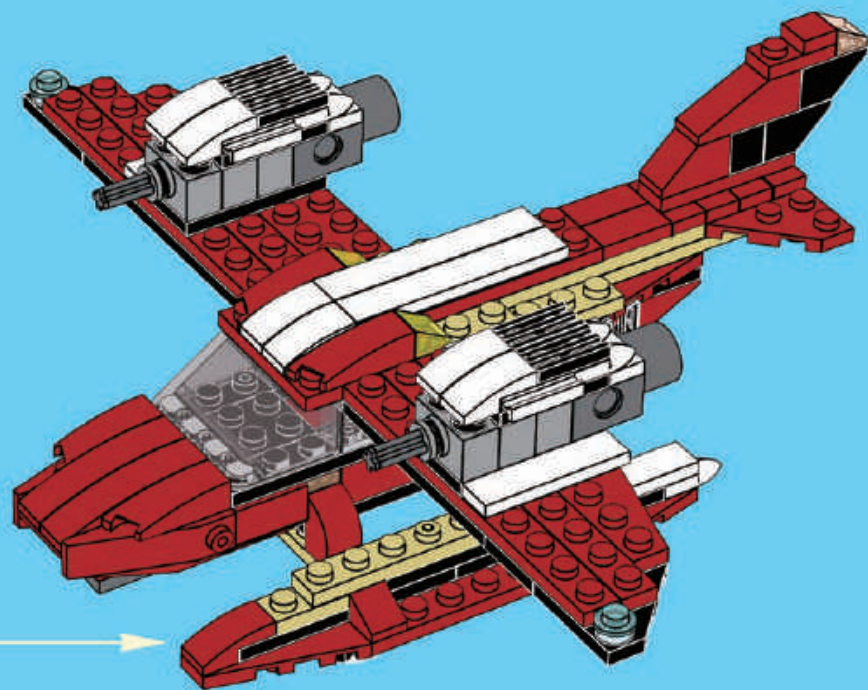



4x



2x

32

1



2



2x

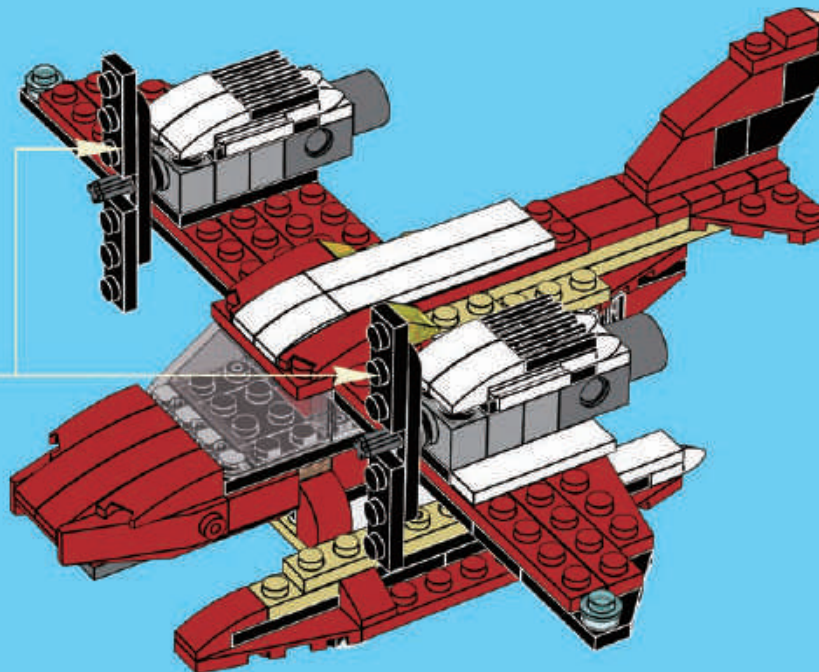



4x



2x

33

1



2



2x

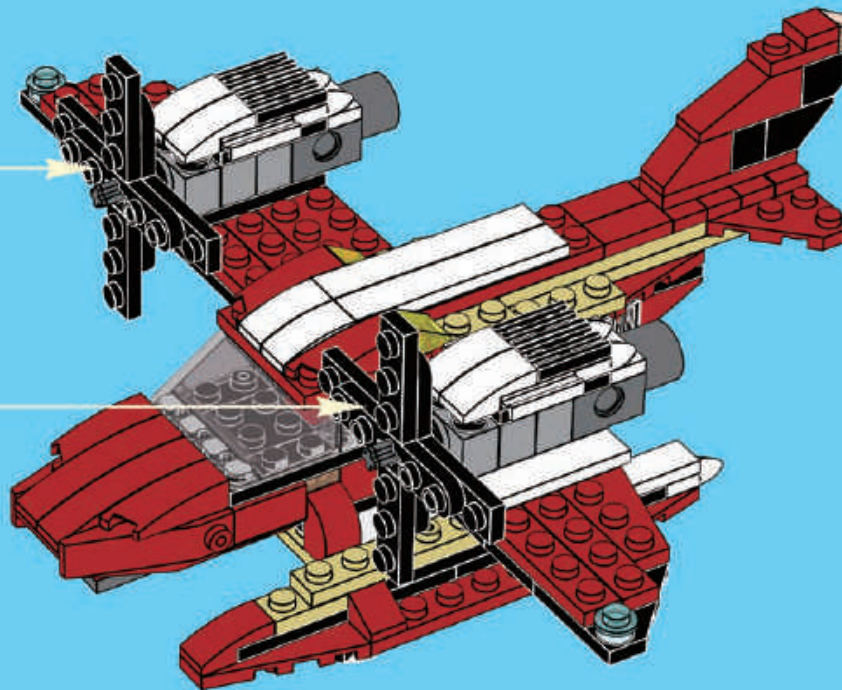



34

