

## V-1 SPARK MACHINE

USER MANUAL

# 1 BEFORE YOU BEGIN

## 1.1 What is Included



V-1 Spark Machine × 1



Power Cord × 1



Warranty Card × 1

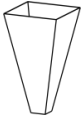

Spark Seed Filling Funnel × 1



Spark Seed Recycling Tube × 1

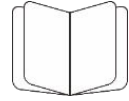



User Manual × 1

## 1.2 Unpacking Instruction

Carefully unpack the product immediately and check the container to make sure all the parts are in the package and are in good condition.

If the box or the contents (the product and included accessories) appear damaged from shipping, or show signs of mishandling, notify the carrier immediately. In addition, keep the box and contents for inspection.

## 1.3 Symbols

Symbol	Meaning
	<b>Caution</b> Critical installation, configuration, or operation information. Not following these instructions may make the product not work, cause damage to the product, or cause harm to the operator.
	<b>Important</b> Important installation or configuration information. Failure to comply with this information may keep the product from working correctly.
	<b>Information</b> Useful information.

## 1.4 Disclaimer

The information and specifications contained in this User Manual are subject to change without notice.

DJPOWER assumes no responsibility or liability for any errors or omissions and reserves the right to revise or to create this manual at any time.

Copyright © 2022 DJPOWER. All rights reserved.

## 1.5 Safety Notes

Please read the following Safety Notes carefully before working with the product. The notes include important safety information about installation, usage, and maintenance.

### 1.5.1 Personal Safety

- Always connect the product to a grounded circuit to avoid the risk of electrocution.
- During heating up and operation, the housing will be scalding hot. Do not touch.
- The product is very hot during operation and it remains hot for a long time after operation has stopped. Do not touch the product's nozzle.
- Keep a minimum distance of 6.6 ft.(2 m) from the machine to the nearest human or flammable material. The output spark from the nozzle must be in the air but not reaching any object. And mind the falling residue after the spark.
- Make sure that children, unauthorised people and animals do not obtain access to the machine.
- The operation noise is lower than 80 dB without harm to ear. No need to wear ear protection when close to the working machine.
- Eye protection is always required when operate the machine closely.

### 1.5.2 Mounting and Rigging

- When using outdoors, for best effects, please place it away from wet ground.
- For safety reasons, we do not recommend mounting the product in any capacity. Operate the product while it is on the ground only.
- The product is for indoor use! To prevent risk of fire or shock, do not expose the product to rain or moisture. Optional waterproof case is available for operating in rain.
- CAUTION: When transferring product from extreme temperature environments,(e.g. cold truck to warm humid ballroom) condensation may form on the internal electronics of the product. To avoid causing a failure, allow product to fully acclimate to the surrounding environment before connecting it to power.
- Do not mount the product on a flammable surface(linoleum, carpet, wood, paper, carton, plastic, etc.).
- Do not use in a confined space. Always install the product in a location with adequate ventilation, at least 20 in(50 cm) from adjacent surfaces.
- Be sure that no ventilation slots on the product's housing are blocked.

### 1.5.3 Power and Wiring

- Always make sure that the voltage of the outlet to which you are connecting the product is within the range stated on the decal or rear panel of the product.
- Make sure the power cord is not crimped or damaged.
- Never connect this product to a dimmer pack or rheostat.
- Never disconnect the product from power cord by pulling or tugging on the cord.
- To eliminate unnecessary wear and improve its lifespan, during periods of non-use completely disconnect the product from power via breaker or by unplugging it.

### 1.5.4 Operation

- Do not operate this product if you see damage to the housing or cables. Have the damaged parts replaced by an authorized technician at once.
- Make sure there are no flammable materials close to this product while it is operating.
- Do not cover or plug the output nozzle during operation.
- Do not use the product as a space heater.
- Never carry the product by the power cord or any moving part. Always use the handles.
- Empty the storage bin before transporting the product.
- The maximum ambient temperature( $T_a$ ) is 104 F(40 °C). Do not operate the product at higher temperatures.
- Always disconnect the product from the power source before cleaning.
- This product contains no user-serviceable parts. Any reference to servicing in this User Manual will only apply to properly trained, certified technicians. Do not open the housing or attempt any repairs which can lead to damage or malfunction.
- In the event of a serious operating problem, stop using the product immediately.
- Use only DJPOWER Spark Seed PRO-K.



**Keep this User Manual for future use. If you sell the product, be sure that the purchaser receives this document.**

## 2 INTRODUCTION

### 2.1 Description

The Spark machine produces a fantastic, non-hazardous effect that look like traditional fireworks or pyrotechnics, adopting brand-new control system and standard DMX Control to realize multiple stage special effects.

It thoroughly changed the drawbacks on traditional cold fireworks such as danger caused by gunpowder, environmental pollution, restricted for use etc.

The duration and height of the effect can be varied throughout a display, with sequences of ' dancing' sparks created to entertain audiences.

### 2.2 Features

- Safety, without gunpowder; Much safer than using traditional pyrotechnics.
- No hazardous materials; Can be used indoor.
- Environmental friendly, no smoke and odor.
- Intelligent and digitalized; Recyclable with low consumption.
- Easy operation and user friendly.
- Up to 15 minutes of effect can be produced from just one-time powder refill.
- Adjustable output height up to 5 meters.

## 2.3 Product Overview

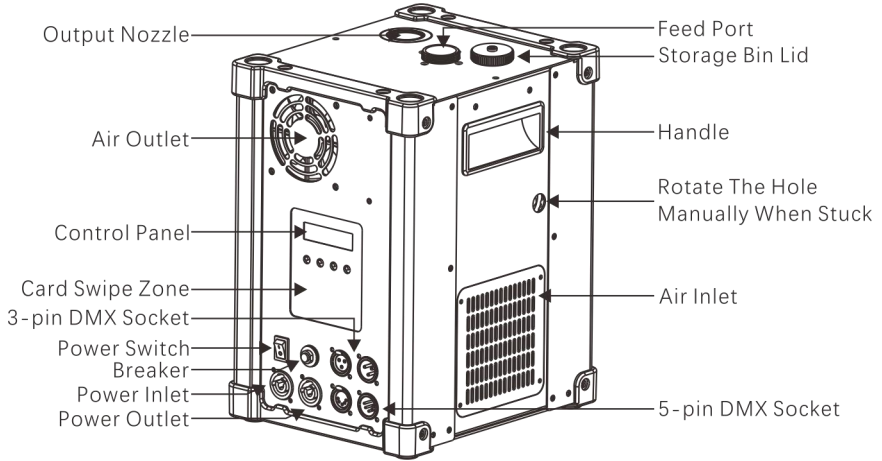

## 2.4 Product Dimensions

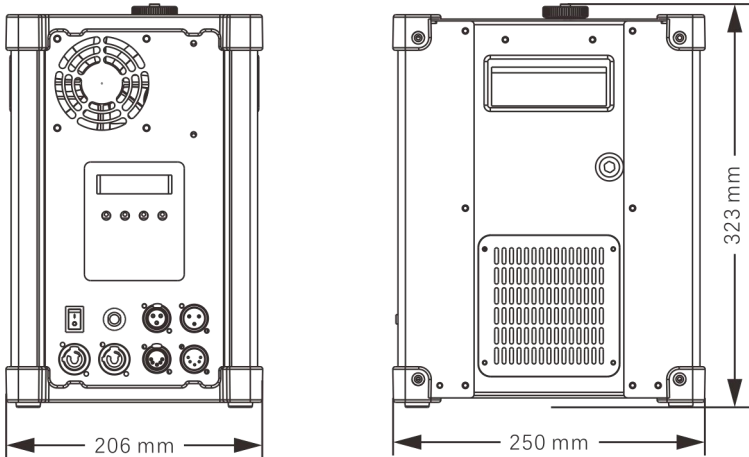

## 3 TECHNICAL SPECIFICATIONS

	Input Voltage & Rate	110-120 V, 50/60 Hz	220-240 V, 50/60 Hz
<b>AC Power</b>	Current Limiter Specifications	8 A, 250 V	5 A, 250 V
	Typical Current	5.8 A	3.0 A
	Current Limiter Type	Breaker	

	Nominal Total Power Consumption	700 W
	Power Input Connector	Lockable PowerCon
	Power Output Connector(Daisy Chained)	Lockable PowerCon
<b>Heating</b>	Heat Up Time	< 3 min
	Re-heat Up Time	0 min
<b>Capacity</b>	Powder Tank Capacity	200 g
<b>Output</b>	Adjustable Output	√
	Adjustment Level/Range	Level 1-10
	Max Output Height	5 m
	Powder Consumption (100% Output)	Approx.14 g/min
	Maximum Continuous Duration(100% Output)	30 s
	Continuous Output	×
	Consumable Type for Standard Output Test	PRO-K
<b>Accessory</b>	Power Cord	√
	Wireless Controller (Controller Model)	×
	Wired Controller(Controller Model)	×
<b>Placement &amp; Mounting</b>	Horizontal	√
	Inclined	√
	Vertical	×
	Hang Upside Down	×
	Rigging & Trussing	×
	Rotating Nozzle	×
	Deflector	×
<b>Features</b>	Operation Noise	1 m, 80 dB
<b>Control</b>	On-device Manual Control	LCD control board
	Wireless Control	×
	Wired Control	×
	Control Protocol	DMX-512
	DMX Channel Range	2
	RFID Card	√
<b>Certification</b>	CE	√
	RoHS	√

	Net Weight	10.0 kg
<b>Weight &amp; Dimensions</b>	Gross Weight	11.5 kg
	Machine Dimensions	206 × 250 × 323 mm
	Packing Dimensions	290 × 335 × 415 mm
<b>Consumable</b>	Consumable	PRO-K

## 4 SETUP

### 4.1 AC Power

The machine has a fixed voltage power supply and can work with an input voltage of AC 110 V-120V,50/60 Hz or AC220 V-240 V,50/60 Hz, depending on the specific model.

To determine the product's power requirements(circuit breaker, power outlet, and wiring), use the current value listed on the label affixed to the product's back panel, or refer to the product's specifications chart. The listed current rating indicates the product's average current draw under normal conditions.



**Always connect the product to a protected circuit(circuit breaker or fuse). Make sure the product has an appropriate electrical ground to avoid the risk of electrocution or fire.**



**Never connect the product to a rheostat(variable resistor) or dimmer circuit, even if the rheostat or dimmer channel serves only as a 0 to 100% switch.**

### 4.2 AC Plug

The Spark Machine V-1 comes with a power input cord terminated with a Seetronic Powerkon connector on one end and an EU plug on the other end(EU & China market). If the power input cord that came with your product has no plug, or if you need the change the plug, use the table below to wire the new plug:

Connection	Wire(U.s.)	Wire(Europe)
<b>AC Live</b>	Black	Brown
<b>AC Neutral</b>	White	Blue
<b>AC Ground</b>	Green/Yellow	Green/Yellow

### 4.3 Resetting the Breaker

This product is equipped with a resettable breaker. If the breaker trips, all sections of this product will lose power.

- Remove the power cord from mains power.
- Allow unit to cool for 15 minutes.
- After 15 minutes, you may attempt to reset the breaker by pressing the button with your finger.
- Plug the product's power cord into the power outlet and continue using as recommended.

## 4.4 DMX Linking

You can link the V-1 to a DMX controller using a 3-or 5-pin DMX connection. If using other DMX-compatible products with this product, you can control each individually with a single DMX controller. Instructions for connecting and configuring this product for DMX operation are in the User Manual.

## 4.5 Mounting

Before mounting the product, read and follow the safety recommendations indicated in the Safety Notes.

### 4.5.1 Orientation

For safety reasons, we do not recommend mounting the product in any capacity. Operate the product while it is on the ground only, and make sure there is adequate room for ventilation, configuration, and maintenance.

### 4.5.2 Rigging

DJPOWER recommends using the following general guidelines when mounting this product.

- Before deciding on a location for the product, make sure there is easy access to the product for maintenance and programming purposes.
- Make sure that the structure or surface onto which you are mounting the product can support the product's weight(see the Technical Specifications).
- When mounting the product on the floor, make sure that the product and cables are away from people and vehicles.

# 5 OPERATION

## 5.1 Preparing for Operation

- After checking that all the parts are intact and complete, position the machine on flat.
- Fill the consumable into feed port when power off.
- Always connect the product to a grounded circuit. Before power on, make sure it is connected with the rated voltage.
- Turn on the machine, it will immediately start heating up.

## 5.2 On-device Control Panel

To access the control panel functions, use the four buttons located underneath the LCD display

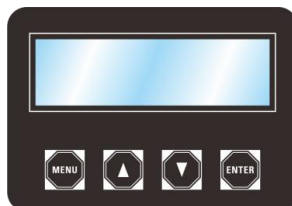



Button	Function
<MENU>	Switch menu pages to select a function
▲	Increases the numeric value of current function
▼	Decreases the numeric value of current function
<ENTER>	Switch between current menu page and Standby Page

## 5.3 On-device Control Mode & Operation



### 5.3.1 Programming

- Refer to the Menu Map to understand the menu options. The menu map shows the main level and a variable number of programming levels for each option.
- To go to the desired main level, press <MENU> repeatedly until the option shows on the display. This will take you to the first programming level for that option.
- To select an option or value within the current programming level, press ▲ or ▼ until the option shows on the display. If there is another programming level, you will see that first option, or you will see the selected value.
- Press <MENU> repeatedly to switch menu pages.
- Press <ENTER> to switch between current menu page and Standby Page at any time

### 5.3.2 Menu Map

	Display	Description	Parameter Range
Preparing Page	Heating Up >>>>>Temp.585	The machine is heating up. The machine could only start working when reach the pre-set target temperature.	530 - 600°C
	Ready to Spark >>>>>Temp.585	Finished heating up, ready to work. Displays current heating system temperature. Press <ENTER> to get back to this page at any time(not DMX mode).	
Manual Mode Pages	Auto Heat-up ON	Press ▲ or ▼ to switch ON/OFF Auto Heat-up function.	ON/OFF
	Manual Spark OFF	Press ▲ or ▼ to trigger spark output manually	ON/OFF

 The default setting of Auto Heat-up is ON. The Heat-up starts when the machine is powered on. LCD will keep showing "Heating Up" until the heating system reaches pre-set target temperature. When the LCD reads "Ready to Spark", the machine is available for spark effect at the moment.

Display	Description	Parameter Range	
<div style="border: 1px solid black; padding: 5px; width: fit-content;">           Spark ON            &gt;&gt;&gt;&gt;&gt;Temp.585         </div>	<p>The machine is outputting spark.</p> <p>The LCD will automatically switch to this page after Manual Spark is on for 5 seconds.</p> <p>Press any button, the LCD will go back to previous page "Manual Spark ON", and press ▲ or ▼ again to switch OFF Manual Spark.</p>		
<p> <b>The longest duration of single time of Manual Spark output is 30 seconds when machine works properly. The machine will automatically stop after 30 seconds continuous output with LCD showing "Manual Spark OFF". For longer output, just turn on Manual Spark again.</b></p>			
<div style="border: 1px solid black; padding: 5px; width: fit-content;">           Spark Height  <span style="float: right;">10</span> </div>	<p>Press ▲ or ▼ to set the Spark height of Manual Spark from level 1 (minimum) to 10(maximum).</p>	1-10	
<b>DMX Configuration Page</b>	<div style="border: 1px solid black; padding: 5px; width: fit-content;">           DMX Address  <span style="float: right;">512</span> </div>	<p>Press ▲ or ▼ to set the DMX starting address</p>	1-512
	<div style="border: 1px solid black; padding: 5px; width: fit-content;">           Remaining Time            0 Min 21 Sec         </div>	<p>Check remaining run-time</p>	
<b>Status Pages</b>	<div style="border: 1px solid black; padding: 5px; width: fit-content;">           Device Error  <span style="float: right;">E0</span> </div>	<p>Errors happen when this page shows.</p> <p>Different codes "E#"represent different errors.</p>	
	<p> <b>Refer to "General Troubleshooting"chapter to for a brief description of each error code.</b></p>		
<div style="border: 1px solid black; padding: 5px; width: fit-content;">           Time is Up  <span style="float: right;">E5</span> </div>	<p>There's no remaining run-time for machine to continue output when this page shows.</p> <p>Swipe a new card to top up run-time.</p>		
<p> <b>Refer to "Identify &amp; Activate Spark Seed"chapter to for more information.</b></p>			

## 5.4 DMX Mode & Operation

The Spark Machine V-1 works with a DMX controller.

- Connect the product to a suitable power outlet.
- Turn the product on.
- Connect a DMX cable from the DMX output of the DMX controller to the DMX input socket on the product.



Set the Spark Machine V-1 starting address in the 001-512 DMX range. This enables control of up to 256 products in the 2-channel personality.

### 5.4.1 Starting Address

When selecting a starting DMX address, always consider the number of DMX channels. If you choose a starting address that is too high, you could restrict the access to some of the product's channels.



**DJPOWER@ V-1 DMX uses only 2 DMX channels, which defines the highest configurable address to 511 to have all channels controllable.**



Connect a DMX cable from the DMX output of the DMX controller to the DMX input socket on the product, or press repeatedly "MENU" button until the LCD shows "DMX Address". Press "▲" or "▼" to set desired DMX starting address.

### 5.4.2 DMX Mode Menu Map

	Display	Description	Adjustable Range
Preparing Page		The selected DMX starting address is 1.	1 - 512
		The machine is heating up.	
Standby Page		The selected DMX starting address is 1.	1 - 512
		Finished heating up, ready to work.	
Operation Page		The selected DMX starting address is 1.	1 - 512
		The machine is outputting spark.	
		<b>The longest duration of single time of spark output is 30 seconds when machine works properly. The machine will automatically stop after 30 seconds continuous output with LCD showing "Spark OFF". For longer output, just turn on spark again via DMX controller.</b>	
Status Pages		The selected DMX starting address is 1.	1 - 512
		The machine is having error. Error code is E0.	
		<b>Refer to "General Troubleshooting" chapter to for a brief description of each error code.</b>	
Status Pages		The selected DMX starting address is 1.	1 - 512
		There's no remaining run-time for machine to continue output when this page shows. Swipe a new card to top up run-time.	
		<b>Refer to "Identify &amp; Activate Spark Seed" chapter to for more information.</b>	

### 5.4.3 DMX Channel Assignments and Values

Channel	Function	Value	Description
1	Spark Height	000 - 009	Spark OFF
		010 - 035	Spark height level 1
		036 - 060	Spark height level 2
		061 - 085	Spark height level 3
		086 - 110	Spark height level 4
		111 - 135	Spark height level 5
		136 - 160	Spark height level 6
		161 - 185	Spark height level 7
		186 - 210	Spark height level 8
		211 - 235	Spark height level 9
		236 - 255	Spark height level 10
2	Safety Channel	0 - 9	Device enabled
		10 - 60	Consumable cleaning up
		61 - 120	Emergency stop/Device disabled
		121 - 182	Auto Heat-up OFF,spark output(channel 1) disabled
		183 - 255	Auto Heat-up ON,spark output(channel 1) disabled

### 5.5 Correspondence of Spark Height & Spark Density

Spark Height	Spark Density
Height level 1(Minimum)	Density level 1(Minimum)
Height level 2	Density level 2
Height level 3	Density level 3
Height level 4	Density level 4
Height level 5	Density level 5
Height level 6	Density level 6
Height level 7	Density level 7
Height level 8	Density level 8
Height level 9	Density level 9
Height level 10(Maximum)	Density level 10(Maximum)



The internal temperature increases dramatically after continuous high-level output, which might cause clogging and failure.

## 5.6 Run-Time

### 5.6.1 Check Remaining Time

In, on-device control mode, press <MENU> repeatedly until the following page shows on the display to check the remaining run-time.

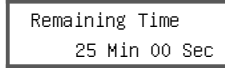

### 5.6.2 Run-Time is Up

There's no remaining run-time for machine to continue output when this page shows. Swipe a new card to top up run-time.

On-device Control Mode

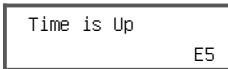

DMX Mode

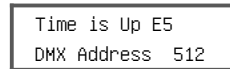

## 5.7 Advanced Settings Interface

### 5.7.1 Enter And Exit Advanced Settings Interface

Press <ENTER>for 3s to enter Advanced Settings Interface. Press <MENU>repeatedly until the option shows on the display. To select an option or value, press ▲ or ▼ until the option shows on the display.

### 5.7.2 Menu Map of Advanced Settings Interface

	Display	Description	Adjustable Range
		<b>Temperature set</b>	
	<p>Temperature Set [ 500 ] 585</p>	Press ▲ or ▼ to adjust the temperature according to the effect of spark. The default temperature is 585°C.  Left is current temperature, right is adjustable target temperature.	530 - 600°C
Advanced Settings	<p>Display Dimmer 10</p>	Press ▲ or ▼ to adjust display brightness.	1-10
	<p>Keypad Tone ON</p>	Press ▲ or ▼ to turn ON/OFF keypad tone.	ON/OFF
	<p>Press ENTER to Exit Settings</p>	Press <ENTER>to exit Advanced Settings Interface.	

## 6 SPARK SEED

Spark Seed is the consumable specially designed for DJPOWER Spark Machine, to create light golden color cold firework for stage effect.

### 6.1 Identify & Activate Spark Seed

- Swipe the Consumable ID card that come with the Spark Seed to identify the consumables about to be filled into the fixture.

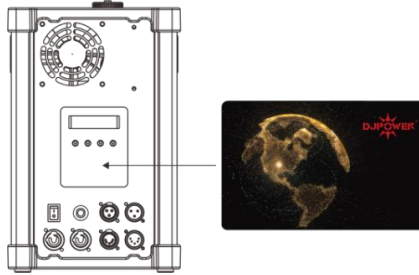

- When the LCD on the fixture shows the information of the Spark Seed after successfully swiping card, the identified Spark Seed could be filled into the fixture.

CardID : 12345678
Top-up : 25 Min

- Please properly keep the Spark Seed ID Card and corresponding Spark Seed before swiping, and properly dispose of the invalid card after swiping and identifying.



**Every Spark Seed ID Card, which is attached to the Spark Seed pouch, stores corresponding run-time information. The run-time for 200g pouch card is 25 minutes.**

**Every 200g Spark Seed could output 12-15 minutes Spark at highest output level(Spark height level 10).**

**When swiping multiple cards at one time, or swipe a new card before the machine runs out of run-time, the run-time will be cumulative.**

### 6.2 Fillin Spark Seed

Tear open the vacuum resealable foil pouch, and fill in the Spark Seed through the feed port on the top of the fixture depending on the dosage needed.



#### **Consumable Feed Port & Storage Bin**

##### **(Filling & Refilling Procedures)**

- **Open the magnetic hinged lid.**
- **Fill the consumable into the feed port, NOT into the output nozzle when power off.**
- **Close the lid securely after filling.**
- **The capacity of storage bin is 200g.**
- **Only use DJPOWER consumable.**

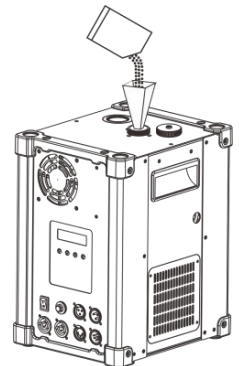

### 6.3 Step of cleaning powder stuck

When the machine is stuck, you can follow the prompts on the front of the machine to clean up the powder stuck.



#### Step of cleaning powder stuck

- When the machine is stuck, please use the manual rotation port for sticking and rotate it in the direction shown in the figure to clear the powder stuck.

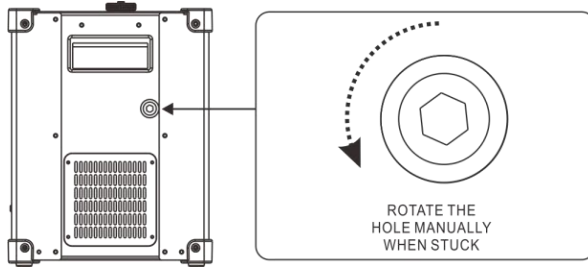

### 6.4 Precaution for use

- The Spark Seed could be only filled in and used for the DJPOWER Spark Machine after successfully identified by swiping Consumable ID card.
- Make sure to fill the Spark Seed through the feed port on the top of the fixture and when power supply is off.
- Use Dry Chemical Extinguishers once lighting a fire. DO NOT use Water-Type Extinguishers, Foam Extinguishers or Carbon Dioxide Extinguishers.

## 7 TECHNICAL INFORMATION

### 7.1 Maintenance

The V-1 requires minimal upkeep in order to maintain optimum performance. However, some steps are needed in order to clean and maintain the product for maximum usage. The recommended procedure is as follows:

- After a period of using, check if there is any consumable tuberculation inside the nozzle. Do necessary cleaning up if there has some, or it may affect spark performance, even damage the machine.



**Test-run your DJPOWER® V-1 on a monthly basis to achieve the best performance.**

### 7.2 Storage

#### 7.2.1 Machine Storage

Before storing the machine, empty the storage bin, clean it as described in the "Maintenance" section. And keep the machine in dry cool place.



### Empty the storage bin:

- Remove the power cord from mains power, and allow unit to cool down. Empty the storage bin through feed port by inverting the machine.
- Run the machine to generate Spark till out of Spark Seed, or run Consumable Cleaning Up procedure (Safety channel, channel 2) to completely clear remaining Spark Seed inside the nozzle.



Refer to "DMX Channel Assignments and Values" chapter to for more information.



Spark Seed would easily get damp in the open air and deliver poor spark effect. Storing damp Spark Seed in the machine storage bin will do harm to machine and cause clogging. Please empty the storage bin after each use.

## 7.2.2 Spark Seed Storage & Recycling

### 7.2.2.1 Sealed Spark Seed Storage

Spark Seed should be stored in a cool, dry place, vacuum packed in resealable foil bags, and protected from moisture, heat, hot surface, open fire and other ignition sources.

### 7.2.2.2 Spark Seed Recycling

Store the unfinished Spark Seed in the Recycling Tube with the Funnel. Keep it sealed and away from moisture.



## 7.3 General Troubleshooting

### 7.3.1 Device Error Description

When error happens, device will stop working and heating system shuts off automatically. LCD shows corresponding error code.

### 7.3.2 Device Error Menu Map

Errors	Display	Possible Cause
Over heat shutdown	Device Error E0	The heating system temperature is higher than 700°C over 30 seconds.
Heating up failed	Device Error E1	Heating system cannot reach pre-set target temperature after 10-min heat-up



<b>Errors</b>	<b>Display</b>	<b>Possible Cause</b>
<b>Over current protection for motor</b>	Device Error E2	Consumable feeding motor failed
<b>Thermocouple failed</b>	Device Error E3	Short circuit or wrong connection of thermocouple
<b>Thermocouple tripped off</b>	Device Error E4	Open circuit or no connection of thermocouple
<b>No remaining run-time</b>	Device Error E5	No remaining run-time
<b>Internal temperature too high</b>	Device Error E6	The internal temperature is higher than 60°
<b>Motor error</b>	Device Error E7	Stepper motor cannot be reset.
<b>Power line frequency abnormal</b>	Device Error E8	Power input frequency is abnormal.

