

MASTECH®

MS2028A

AC DIGITAL CLAMP METER

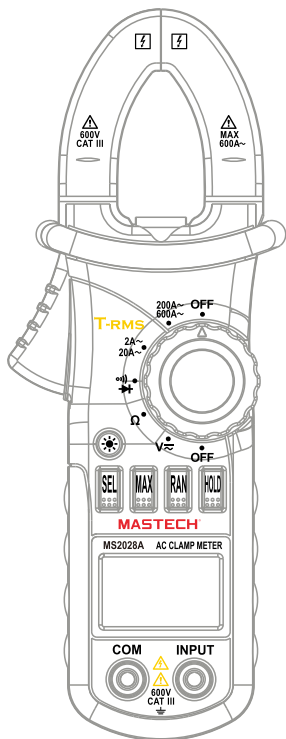

MASTECH®

CONTENTS

1. SAFETY INFORMATION	4
1.1 PRELIMINARY	4
1.2 DURING USE	4
1.3 SYMBOLS	5
1.4 MAINTENANCE	6
2. DESCRIPTION	6
2.1 NAMES OF COMPONENTS	8
2.2 SWITCH, BUTTONS AND INPUT JACKS	8
2.3 LCD (Liquid-crystal display)	9
3. SPECIFICATIONS	10
3.1 GENERAL SPECIFICATIONS	10
3.2 ELECTRICAL SPECIFICATIONS	10
4. OPERATION INSTRUCTIONS	13
4.1 HOLD READINGS	13
4.2 SWITCHING RANGES	13
4.3 MAXIMUM VALUE	13
4.4 SWITCHING FUNCTIONS	13
4.5 BACK LIGHT	13
4.6 AUTO POWER OFF	14

CONTENTS

4.7 PREPARING FOR MEASUREMENT	14
4.8 MEASURING AC CURRENT	15
4.9 MEASURING AC VOLTAGE	17
4.10 MEASURING DC VOLTAGE	19
4.11 MEASURING RESISTANCE	21
4.12 TESTING DIODES	23
4.13 TESTING CONTINUITY	25
5. MAINTENANCE	27
5.1 REPLACING THE BATTERIES	27
5.2 REPLACING TEST LEADS	27
6. ACCESSORIES	28

1. SAFETY INFORMATION



WARNING

Be extremely careful when using this meter. Improper use of this device can result in electric shock or destruction of the meter. Take all normal safety precautions and follow the safeguards suggested in this manual. To exploit full functionality of the meter and ensure safe operation, please read carefully and follow the directions in this manual. If the equipment is used in a manner not specified by the manufacturer, the protection provided by the equipment may be impaired.

This meter is designed and manufactured according to safety requirements of EN 61010-1, EN 61010-2-032, EN 61010-2-033 concerning electronic measuring instruments with a measurement CAT III 600V and pollution degree 2 and safety requirements for hand-held clamps for electrical measurement and test.

1.1 PRELIMINARY

- 1.1.1 When using the meter, the user must observe all normal safety rules concerning:
 - General protection against electric shock
 - Protection of the meter against misuse
- 1.1.2 When the meter is delivered, check whether it has been damaged in transit.
- 1.1.3 After being stored under harsh conditions, the meter should be checked and confirmed for any damages that may have occurred.
- 1.1.4 Test leads must be kept in good condition. Before using, check whether the insulation on test leads has been damaged and any wire has been exposed.
- 1.1.5 Use the test leads supplied to ensure operational safety. If required, they must be replaced with test leads of the same model or class.









1.2 DURING USE

- 1.2.1 Do not take measurements that exceed the protection limit values indicated in the specifications.
- 1.2.2 Do not touch the metal tips of the test leads when the meter is connected to the circuit being measured.
- 1.2.3 Keep your fingers behind the probe barriers when taking measurements with an effective voltage above 60V DC or 30VAC rms.

MASTECH®

- 1.2.4 Do not take voltage measurements if the value between the terminals and earth ground exceeds 600V.
- 1.2.5 Select the highest range if the value to be measured is unknown.
- 1.2.6 Disconnect the test leads from the circuit under test before turning the rotary selector to change functions.
- 1.2.7 Do not measure the resistance, diode or continuity of live circuits.
- 1.2.8 Do not connect the meter to any voltage source while the rotary selector is in the current, resistance, diode or continuity range.
- 1.2.9 Do not use the meter near explosive gases, steam or dirt.
- 1.2.10 Stop using the meter if any abnormalities or faults are observed.
- 1.2.11 Do not use the meter unless its rear case and battery cover is securely fastened in its original position.
- 1.2.12 Do not store or use the meter in areas exposed to direct sunlight, at high temperatures or with high relative humidity.

1.3 SYMBOLS

	Note-Important safety information, refer to the instruction manual.
	Application around and removal from UNINSULATED HAZARDOUS LIVE conductors is permitted.
	Caution, possibility of electric shock
	Equipment protected throughout by double insulation or reinforced insulation.
	Conforms to UL STD. 61010-1, 61010-2-032, 61010-2-033; Certified to CSA STD C22.2 NO. 61010-1, 61010-2-032, 61010-2-033
	Complies with European (EU) safety standards
	Earth (ground) TERMINAL
	Direct current
	Alternating current

CAT III: MEASUREMENT CATEGORY III is applicable to test and measuring circuits connected to the distribution part of the building's low-voltage MAINS installation.

MASTECH®

1.4 MAINTENANCE

1. Do not attempt to remove the rear case to adjust or repair the meter. Such actions should only be performed by a technician who fully understands the meter and the danger involved.
2. Before opening the case and battery cover of the meter, always disconnect the test leads from all sources of electric current.
3. To avoid any electric shock caused by incorrect readings, replace the batteries immediately when the  symbol appears on the display.
4. Use a damp cloth and mild detergent to clean the meter; do not use abrasives or solvents.
5. Turn the rotary selector to OFF position to switch off the power when the meter is not in use.
6. Remove the batteries to avoid damage to the meter if it will not be used for a long time.

2. DESCRIPTION

- This meter is a portable professional measuring instrument with an LCD with backlight for easy reading. The 'single-hand operation' design of the range switch makes measurement simple and easy. Overload protection and low battery indication are provided. It is an ideal multi-function Instrument with lots of practical applications for professional, workshop, school, hobby and home use.
- The meter can perform measurements of AC current, AC/DC voltage, resistance, continuity and diodes.
- Both auto-range and manual ranges are available.
- This meter is equipped with a reading hold function.
- This meter is equipped with a maximum measured value function.
- This meter has an auto power off feature.
- The normal function of the product may be disturbed by strong Electro-Magnetic interference. If so, simply reset the product to resume normal operation by following the instruction manual. In case the function could not resume, please use the product in other location.

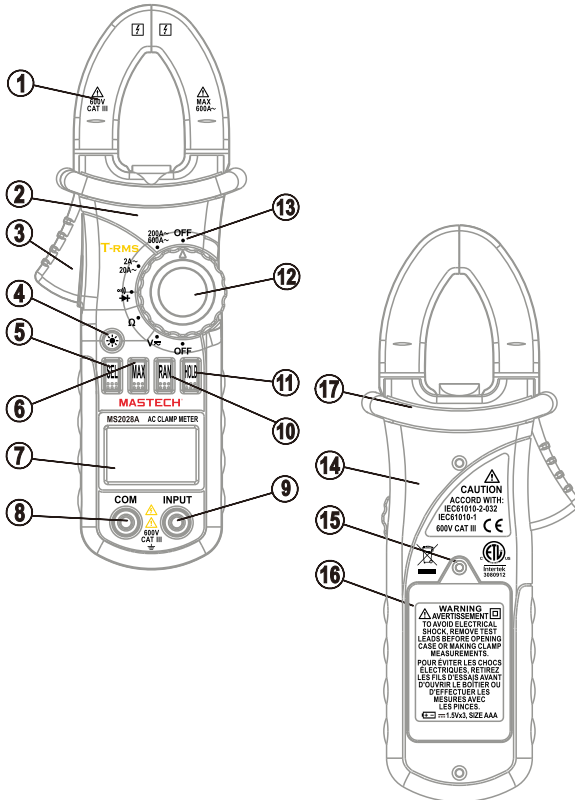

2.1 NAMES OF COMPONENTS

- ① Current Clamp
- ② Panel
- ③ Trigger
- ④ Back Light Button (☼)
- ⑤ Function Switch Button (SEL)
- ⑥ MAX Button (MAX)
- ⑦ Liquid Crystal Display (LCD)
- ⑧ COM Jack
- ⑨ Input Jack
- ⑩ Range Button (RAN)
- ⑪ Reading Hold Button (HOLD)
- ⑫ Rotary selector
- ⑬ OFF - power switch
- ⑭ Rear Case
- ⑮ Battery Cover Screw
- ⑯ Battery Cover
- ⑰ Protective Barrier (to warn the operator of the limit of safe access)

2.2 SWITCH, BUTTONS AND INPUT JACKS

- ☼ Button - Turns backlight on/off
- SEL Button - Switches between functions
- MAX Button - Displays maximum measured value
- RAN Button - Switches to manual range.
- HOLD Button - For holding the reading on the display
- INPUT Jack - Positive input connection for measuring voltage, resistance, diode and continuity.
- COM Jack - Common input connection for voltage, resistance, diode and continuity measurements.
- OFF Position - For turning off the power.
- Rotary Selector - For selecting functions and ranges.
- Clamp - For measuring current

2.3 LCD (Liquid-crystal display)

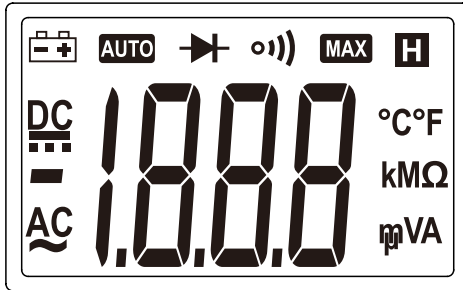

	Alternating current
	Direct current
	Diode test
	Continuity buzzer
AUTO	Auto range mode
MAX	Maximum value
	Low battery
H	Data hold
mV, V	Millivolts, Volts (Voltage)
A	Amperes (Current)
Ω, kΩ, MΩ	Ohms, Kilohms, Megaohms (Resistance)

3. SPECIFICATIONS

Calibration is required once a year, to be carried out at a temperature between 18°C and 28 °C (64°F to 82°F) and relative humidity below 75%.

3.1 GENERAL SPECIFICATIONS

1. Auto range and manual range options are available.
2. Overrange protection is provided for all ranges.
3. Maximum voltage between terminals and earth ground: 600V DC or True RMS AC
4. Operating altitude: max. 2000 meters (7000 ft.)
5. Display: LCD
6. Maximum display value: 1999 digits
7. Polarity indication: '-' for negative polarity.
8. Overrange indication: 'OL' or '-OL'
9. Sampling Time: approx. 0.4 second per sample
10. Unit indication: function and unit.
11. Auto power off time: 15 min.
12. Operating power : 1.5V×3 AAA batteries
13. Low battery indication: '

3.2 ELECTRICAL SPECIFICATIONS

Ambient temperature: 23±5°C Relative humidity: < 75%

3.2.1 AC Current

Range	Resolution	Accuracy
2A	0.001A	±(3.5% of rdg + 20 digits)
20A	0.01A	±(3.0% of rdg + 10 digits)
200A	0.1A	±(1.5% of rdg + 5 digits)
600A	1A	±(1.5% of rdg + 5 digits)

MASTECH®

Max. input current: 600A
Frequency range: 40 to 400Hz
Response: True RMS

3.2.2 AC Voltage

Range	Resolution	Accuracy
2V	0.001V	±(1.0% of rdg + 5 digits)
20V	0.01V	
200V	0.1V	
600V	1V	±(1.2% of rdg + 5 digits)

Input impedance: 10MΩ
Max. input voltage: 600V True RMS AC
Frequency range: 40 to 400Hz
Response: True RMS

NOTE:

At small voltage ranges, unsteady readings will appear before the test leads contact the circuit; this is normal because the meter is highly sensitive. When the test leads contact the circuit, the true reading will be shown.

3.2.3 DC Voltage

Range	Resolution	Accuracy
2V	0.001V	±(0.8% of rdg + 2 digits)
20V	0.01V	
200V	0.1V	
600V	1V	±(1.0% of rdg + 2 digits)

Input impedance: 10MΩ
Max. input voltage: 600V DC

NOTE:

At small voltage ranges, unsteady readings will appear before the test leads contact the circuit; this is normal because the meter is highly sensitive. When the test leads contact the circuit, the true reading will be shown.

MASTECH®

3.2.4 Resistance

Range	Resolution	Accuracy
200Ω	0.1Ω	±(1.2% of rdg + 2 digits)
2kΩ	0.001kΩ	
20kΩ	0.01kΩ	
200kΩ	0.1kΩ	
2MΩ	0.001MΩ	
20MΩ	0.01MΩ	±(2.0% of rdg + 5 digits)

Open circuit voltage: 0.5V

3.2.5 Diode

Range	Resolution	Function
	0.001V	Displays approximate forward voltage of diode

Forward DC current ~ 1mA
Reversed DC voltage ~ 2V

3.2.6 Continuity

Range	Resolution	Function
	0.1Ω	Built-in buzzer will sound if resistance is less than <math><50\Omega\pm 20\Omega</math>

Open circuit voltage ~ 1V

4. OPERATION INSTRUCTIONS

4.1 HOLD READINGS

1. Press the "HOLD" button to hold the current reading on the display.
2. Press the "HOLD" button again to release the hold.

4.2 SWITCHING RANGES

1. The meter's default range is "AUTO" for current, voltage, resistance, capacitance and frequency modes.
2. Press the "RAN" button for manual range mode. Each press of the button will increase the range and will return to the lowest range if the button is pressed at the highest range.
3. Hold down the "RAN" button for 2 seconds to return the meter to auto range.

4.3 MAXIMUM VALUE

1. In voltage and current modes press the "MAX" button to display the maximum measured value.
2. Press the "MAX" button again to return the meter to normal

4.4 SWITCHING FUNCTIONS

1. Press the "SEL" button to switch between AC and DC measurements in voltage mode.
2. Press the "SEL" button to switch between diode and continuity modes.

4.5 BACK LIGHT

1. Hold the '☀️' button to turn on the back light. The light will remain on for 15 seconds before automatically turning off.
2. To manually turn off the back light, hold down the '☀️' button.

NOTE:

LEDs, which require a large working current, are the source of the back light. Although the meter is equipped with a timer that will turn off the back light after 15 seconds, frequent use of the back light will shorten the life of the batteries. Therefore, do not use the back light unless necessary.

When the battery voltage is $\leq 3.6V$, the "🔋" symbol (low battery) will appear on the display. When the back light is on, even if the battery is $\geq 3.6V$, the "🔋" may appear because of the back light's large working current which will cause the voltage to drop. (The accuracy of the measurement cannot be assured when the "🔋" symbol appears.) If so, you need not replace the batteries. The batteries will be good until the "🔋" symbol appears when the back light is not being used.

4.6 AUTO POWER OFF

1. If the meter is not used for a period of 15 minutes, the meter will power itself off.
2. Turn the rotary selector or press any button to resume operation of the meter.

4.7 PREPARING FOR MEASUREMENT

1. Switch on the power by turning the rotary selector. If the battery voltage is less than 3.6V, the "🔋" symbol will appear and the batteries should be replaced.
2. The "⚠️" symbol shows that the input voltage or current should not exceed the specified value in order to protect the internal circuitry from damage.
3. Turn the rotary selector to the required function and range to be measured. Choose the highest range when the value to be measured is unknown.
4. Connect the common test lead first and then the charged test leads when making connection. Remove the charged test lead first when disconnecting.

4.8 MEASURING AC CURRENT

⚠ WARNING

Beware of Electrocutation.
Ensure that the test leads are disconnected from the meter before making current measurements.

1. Set the rotary selector to the appropriate **A~** position.
2. If need be, press the **"RAN"** button to choose manual range mode.
3. Press the trigger to open jaw and fully enclose only one conductor.
4. Read the current value on the display.

NOTE:

- 1) Do not enclose more than one conductor in the jaw.
- 2) For optimum results, center the conductor inside the clamp.
- 3) In manual range mode, when 'OL' is shown on the display it means the measurement has exceeded the range. A higher range should be selected.
- 4) In manual range mode, when the scale to be measured is unknown, set the range to the highest setting.
- 5) "⚠" means the maximum input current is 600A rms AC.

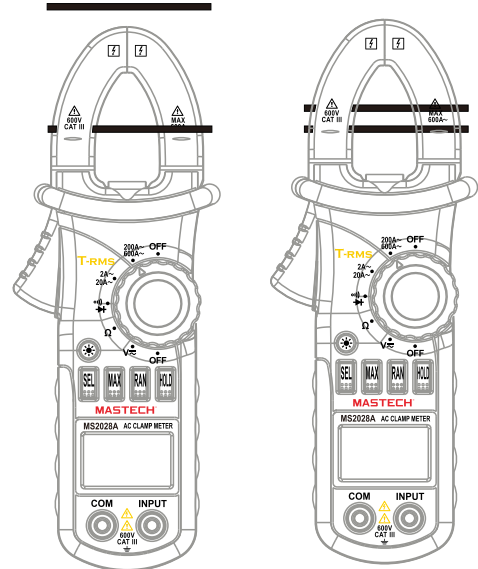

Correct

Incorrect

4.9 MEASURING AC VOLTAGE

⚠ WARNING

Beware of Electrocutation.

Pay special attention to avoid electric shock when measuring high voltages.

Do not measure voltages that may exceed 600V rms AC.

1. Plug the black test lead into the **COM** jack and the red test lead into the **INPUT** jack.
2. Set the rotary selector to the **V_~** position. The meter's default mode is AC voltage.
3. If necessary, press the **"RAN"** button to choose manual range mode.
4. Connect the test leads to the voltage source or load terminals for measurement.
5. Read the voltage value on the display.

NOTE:

- 1) At small voltage ranges, unsteady readings may appear before the test leads contact the circuit. This is normal because the meter is highly sensitive. When the test leads contact the circuit, the true reading will be shown.
- 2) In manual range mode, when 'OL' is shown on the display it means the measurement has exceeded the range. A higher range should be selected.
- 3) In manual range mode, when the value to be measured is unknown beforehand, select the highest range first and lower the range accordingly.
- 4) "⚠" means the maximum input voltage is 600V rms AC.

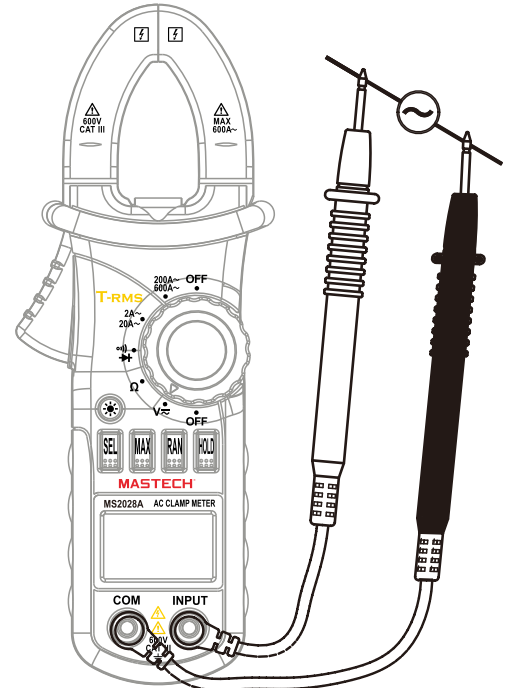

4.10 MEASURING DC VOLTAGE

WARNING

Beware of Electrocutation.

Pay special attention to avoid electric shock when measuring high voltages.

Do not measure voltages that may exceed 600V DC.

1. Plug the black test lead into the **COM** jack and the red test lead into the **INPUT** jack.
2. Set the rotary selector to the **V $\overline{\sim}$** position.
3. Press the "**SEL**" button to switch to DCV measurement.
4. Connect the test leads to the voltage source or load terminals for measurement.
5. Read the voltage value on the display. The polarity symbol denotes the polarity of the red test lead.

NOTE:

- 1) At small voltage ranges, unsteady readings will appear before the test leads contact the circuit. This is normal because the meter is highly sensitive. When the test leads contact the circuit, the true reading will be shown.
- 2) In manual range mode, when 'OL' or '-OL' is shown on the display it means the measurement has exceeded the range. A higher range should be selected.
- 3) In manual range mode, when the scale to be measured is unknown beforehand, select the highest range first and lower the range accordingly.
- 4) "" means the maximum input voltage is 600V DC.

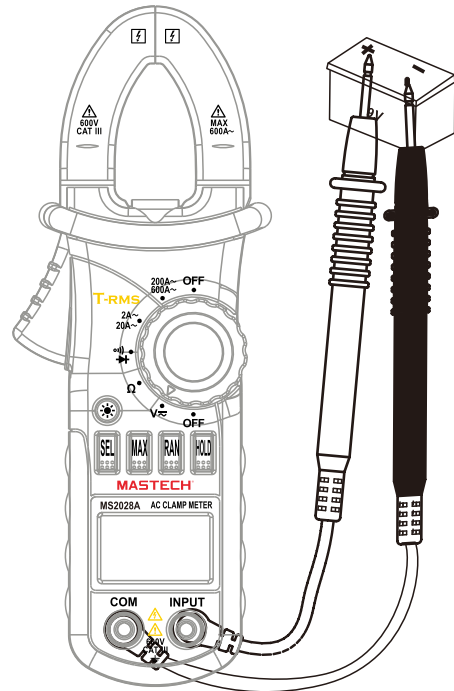

4.11 MEASURING RESISTANCE

WARNING

Beware of Electrocutation.

When measuring in-circuit resistance, make sure that the power of the circuit under test has been turned off and that all capacitors have been fully discharged.

1. Plug the black test lead into the **COM** jack and the red test lead into the **INPUT** jack.
2. Set the rotary selector to the Ω position.
3. If need be, press the "**RAN**" button to choose manual range mode.
4. Connect the test leads to the ends of the resistor or circuit for measurement.
5. Read the resistance value on the display.

NOTE:

- 1) In manual range mode, when 'OL' or '-OL' is shown on the display it means the measurement has exceeded the range. A higher range should be selected.
- 2) When the input is open, 'OL' will appear on the display to indicate that the range has been exceeded.
- 3) For measuring resistances above $1M\Omega$, it may take a few seconds to get a steady reading. This is normal for high resistance measurements.

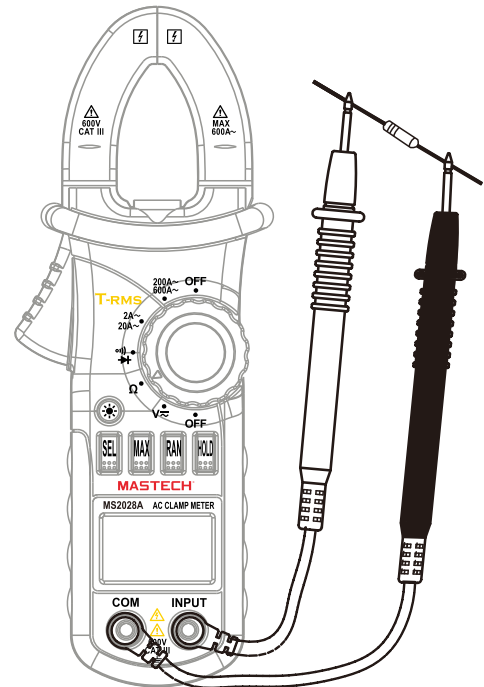

4.12 TESTING DIODES

1. Plug the black test lead into the COM jack and the red test lead into the INPUT jack.
2. Set the rotary selector to the \rightarrow position.
3. Connect the red test lead to the anode (+) and the black test lead to the cathode (-) of the diode.
4. Read the voltage drop value on the display.

NOTE:

- 1) The meter will show the approximate forward voltage drop of the diode.
- 2) When the test leads have been reversed or open, 'OL' will appear on the display.

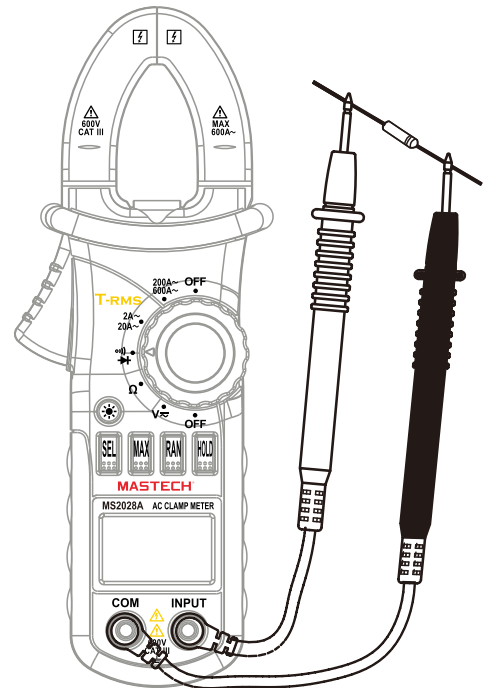



4.13 TESTING CONTINUITY

WARNING

Beware of Electrocutation.

Make sure that the power of the circuit has been turned off and the capacitors have been fully discharged before testing the continuity of a circuit.

1. Plug the black test lead into the COM jack and the red test lead into the INPUT jack.
2. Set the rotary selector to the   position.
3. Press the "SEL" button to switch to  continuity test.
4. Connect the test leads to the two ends of the circuit for measurement.
5. If the resistance of the circuit being tested is less than $<50\Omega \pm 20\Omega$, the built-in buzzer will sound.
6. Read the resistance value on the display.

NOTE:

If the test leads are open or the resistance of the circuit is over 200Ω , "OL" will appear on the display.

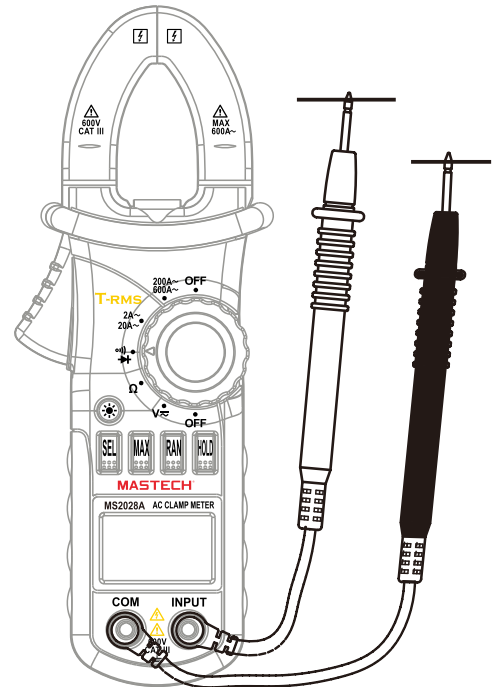

5. MAINTENANCE

5.1 REPLACING THE BATTERIES

⚠ WARNING

To avoid electric shock, make sure that the test leads have been clearly move away from the circuit under measurement before opening the battery cover.

⚠ WARNING

Do not mix old and new batteries. Do not mix alkaline, standard (carbon-zinc), or rechargeable (ni-cad, ni-mh, etc) batteries.

1. If the symbol “” appears, it means that the batteries should be replaced.
2. Loosen the screw of the battery cover and remove it.
3. Replace the used batteries with new ones.
4. Return the battery cover and tighten the screw.

NOTE:

Do not reverse the polarity of the batteries.

5.2 REPLACING TEST LEADS

Replace test leads if leads become damaged or worn.

⚠ WARNING

Use meet EN 61010-031 standard, rated CAT III 600V, or better test leads.

⚠ WARNING

To avoid electric shock, make sure the probes are disconnected from the measured circuit before removing the rear cover. Make sure the rear cover is tightly screwed before using the instrument.

6. ACCESSORIES

1)	Test Leads	1 pair
2)	Operating Manual	1 piece
3)	1.5V AAA Battery	3 pieces
4)	Case	1 piece

