



Architecture

21042

Statue of Liberty La statue de la Liberté Estatua de la Libertad

New York, USA

New York, États-Unis

Nueva York (EE. UU.)



[LEGO.com/architecture/booklet](https://www.lego.com/architecture/booklet)

Liberty

The Statue of Liberty was a gift of friendship from the people of France to the United States, and has since become a universal symbol of freedom and democracy throughout the world. Dedicated on the 28th of October 1886, she was often the first thing people saw as they sailed into New York's harbor to start a new life in America.



A photograph of the Statue of Liberty in New York Harbor, silhouetted against a dramatic sunset sky with dark, heavy clouds. The water in the foreground is dark and textured. The overall mood is somber and contemplative.

*"Thou warden of the western gate, above Manhattan Bay,
The fogs of doubt that hid thy face are driven clean away:
Thine eyes at last look far and clear, thou liftest high thy hand
To spread the light of liberty world-wide for every land."*

Henry van Dyke
Liberty Enlightening the World
1917

The Gift

Édouard de Labouaye was a prominent French political thinker and a strong supporter of President Abraham Lincoln during the American Civil War. In 1865, he proposed creating a monument that would be gifted to the United States by the people of France in celebration of the recent Union victory in the Civil War and the abolition of slavery.

Ten years later, with the help of the sculptor Frédéric-Auguste Bartholdi, Labouaye turned his proposal into reality and founded the Franco-American Union to raise funds for the project. It was hoped that the French people would finance the proposed Statue, now entitled “Liberty Enlightening the World,” while the American people would pay for its pedestal.

On one of his trips to the U.S. to help raise funds, the sculptor Bartholdi realized that New York was the gateway to America and spotted the perfect location for the Statue to stand.



Bedloe's Island was visible to every ship entering or leaving the city's harbor and Bartholdi envisioned his statue rising out of the star-shaped Fort Wood that already stood on the island.

The project soon caught the imagination of many on both sides of the Atlantic, and when the French had raised 400,000 francs the construction of the Statue finally began.

*"...a stream of light shall pierce the darkness
...until Liberty enlightens the world"*

President Grover Cleveland
Dedication speech for the Statue of Liberty
October 28, 1886







From Dream to Reality

In 1876, French craftsmen began forging the individual elements of the Statue. While the outer design and materials were given, the real challenge lay in the Statue's internal construction.

Bartholdi turned to the French architect and structural engineer, Gustave Eiffel, and he proposed creating a 92 ft. (28 m) skeletal central pylon upon which asymmetrical girders could be attached. Flat metal bars were then bolted to the girders to hold the copper skin of the Statue in place. Eiffel would go on to use the same pylon construction method in his famous Eiffel Tower, which was completed in 1889.

The entire Statue was completed in Paris between 1881 and 1884. It arrived amid great fanfare in New York aboard the French Navy ship *Isère* on the 17th of June 1885. Once the pedestal was completed in 1886, the 151 ft. (46 m) tall statue was quickly assembled. The last section to be completed was the Statue of Liberty's face, which remained covered until the official dedication on the 28th of October 1886. Rain and foggy weather did not stop over one million New Yorkers from turning out to cheer the unveiling of the new Statue.

*"Keep, ancient lands, your storied pomp!" cries she
With silent lips. "Give me your tired, your poor,
Your huddled masses yearning to breathe free,
The wretched refuse of your teeming shore.
Send these, the homeless, tempest-tost to me,
I lift my lamp beside the golden door!"*

Emma Lazarus
The New Colossus
1883

A Universal Icon

The Statue of Liberty was intended to be seen as a universal symbol of enlightenment and freedom. The robed female figure itself represents Libertas, the Roman goddess of freedom, and although you cannot see her feet clearly she stands among a broken shackle and chains, with her right foot raised, depicting her moving away from oppression and slavery. The seven spikes on the crown represent the seven oceans and the seven continents of the world, reinforcing the universal concept of liberty.

Over time, the Statue would also emerge as a welcoming symbol of hope to different generations of immigrants to the U.S. Between 1886 and 1924, almost 14 million immigrants

entered the United States through New York. The Statue of Liberty was often the first thing they saw as they arrived by ship in their new homeland.

The American National Park Service took over responsibility for the island in 1937, and set about transforming the area around the Statue into a park. Bedloe's Island was renamed Liberty Island in 1957 to commemorate the completion of this work. The Statue was designated a UNESCO World Heritage Site in 1984 and continues to attract around 4 million visitors each year.







Facts & Figures

Style	Neoclassical Sculpture
Materials	Statue: Copper & Iron Pedestal: Stone
Height	Statue: 151 ft. (46 m) Including Pedestal: 305 ft. (93 m)
Weight	224.9 short tons (204 metric tons)
Dedicated	October 28, 1886

Liberté

La statue de la Liberté a été offerte aux États-Unis par le peuple français, en signe d'amitié. Elle est depuis devenue un symbole de liberté et de démocratie dans le monde entier. Inaugurée le 28 octobre 1886, elle a longtemps été la première chose que les gens apercevaient à leur arrivée dans le port de New York, alors qu'ils s'apprêtaient à refaire leur vie aux États-Unis.



A photograph of the Statue of Liberty in New York Harbor, silhouetted against a dramatic sunset sky with dark, heavy clouds. The water in the foreground is dark and textured. The overall mood is somber yet hopeful, reflecting the text's message of hope and freedom.

*« Toi, gardienne de l'Occident,
surplombant Manhattan et sa baie, Les brumes du doute
qui cachait ton visage sont maintenant dissipées :
Ton regard se porte au loin, ta main est fièrement dressée
Pour éclairer de liberté les pays du monde entier. »*

Henry van Dyke
La Liberté éclairant le monde
1917

Le cadeau

Édouard de Laboulaye était un célèbre homme politique français et un grand admirateur du président américain Abraham Lincoln au cours de la guerre de Sécession. En 1865, il propose la création d'un monument qui serait offert aux États-Unis par le peuple français pour célébrer la récente victoire de l'Union et l'abolition de l'esclavage.

Dix ans plus tard, avec l'aide du sculpteur Frédéric Auguste Bartholdi, Laboulaye concrétise sa vision et fonde l'Union franco-américaine afin de recueillir des fonds pour la réalisation du projet. On espère alors que le peuple français assumera les coûts de la statue, nommée « La Liberté éclairant le monde », et que le peuple américain paiera pour son piédestal.

Lors d'un voyage aux États-Unis visant à amasser des fonds, Bartholdi réalise que New York est la porte de l'Amérique. Il repère alors l'endroit idéal pour ériger sa statue. Bedloe's



Island était visible de tous les navires entrant ou sortant du port de la ville. Bartholdi imagine sa statue s'élevant au-dessus de Fort Wood, un fort en forme d'étoile construit sur l'île.

Le projet frappe rapidement l'imagination des deux côtés de l'Atlantique. Les Français ayant amassé 400 000 francs, on commence enfin à bâtir la statue.

*« [...] un rai de lumière percera les ténèbres
[...] jusqu'à ce que la Liberté éclaire le monde »*

Grover Cleveland, président américain
Discours lors de l'inauguration de la statue de la Liberté
28 octobre 1886







Du rêve à la réalité

En 1876, des artisans français commencent à fabriquer les pièces de la statue. L'aspect extérieur et les matériaux ayant été choisis, le véritable défi réside dans la structure interne.

Bartholdi fait appel à l'architecte et ingénieur en structures français Gustave Eiffel et lui propose de bâtir un pylône central de 28 m sur lequel seraient fixées des poutres asymétriques. Des bandes métalliques plates seraient ensuite vissées aux poutres pour retenir les plaques de cuivre formant la surface. Eiffel a par la suite utilisé la même méthode de construction pour sa célèbre tour Eiffel, achevée en 1889.

Les différentes pièces sont assemblées à Paris de 1881 à 1884. Le 17 juin 1885, la statue fait son arrivée à New York en grande pompe à bord de l'Isère, un navire de la marine française. Une fois la construction du piédestal terminée en 1886, la statue, qui s'élève à 46 m, est rapidement réassemblée. La dernière section achevée est le visage, qui reste caché jusqu'à l'inauguration officielle, le 28 octobre 1886. Malgré la pluie et le brouillard, plus d'un million de New-Yorkais se rassemblent pour assister au dévoilement sous les cris et les applaudissements.

*« Garde, Vieux Monde, tes fastes d'un autre âge », proclame-t-elle
De ses lèvres closes. « Donne-moi tes pauvres, tes exténués,
Qui en rangs pressés aspirent à vivre libres,
Le rebut de tes rivages surpeuplés,
Envoie-les-moi, les déshérités, que la tempête me les rapporte
De ma lumière, j'éclaire la Porte d'Or ! »*

Emma Lazarus
Le Nouveau Colosse
1883

Une icône universelle

La statue de la Liberté devait être un symbole universel de sagesse et de liberté. La figure féminine vêtue d'une toge représente Libertas, déesse romaine de la liberté. Ses pieds ne sont pas nettement visibles, mais elle se dresse parmi des chaînes et des fers brisés, son pied droit levé pour indiquer qu'elle laisse derrière elle l'oppression et l'esclavage. Les sept pointes de sa couronne représentent les sept océans et les sept continents du monde, renforçant l'idée de liberté pour tous.

Avec le temps, la statue est aussi devenue une figure d'accueil et d'espoir pour les nombreuses générations d'immigrants aux États-Unis. Entre 1886 et 1924, près de

14 millions d'immigrants sont entrés aux États-Unis en passant par New York. La statue de la Liberté était souvent leur première vision de leur nouvelle patrie, alors que le bateau arrivait au port.

L'American National Park Service prend à sa charge l'administration de l'île en 1937 et entreprend de transformer en parc l'espace entourant la statue. Bedloe's Island est renommée Liberty Island en 1957 pour commémorer la fin des travaux. La statue est inscrite au patrimoine mondial de l'UNESCO en 1984 et attire quelque 4 millions de visiteurs chaque année.







Faits et chiffres

Style	Sculpture néoclassique
Matériaux	Statue : cuivre et fer Piédestal : pierre
Hauteur	Statue : 46 m Avec le piédestal : 93 m
Poids	204 t
Inauguration	28 octobre 1886

Libertad

La Estatua de la Libertad fue un regalo del pueblo de Francia a los Estados Unidos en señal de amistad y se ha convertido en un símbolo universal de la libertad y la democracia en todo el mundo. Inaugurada el 28 de octubre de 1886, a menudo era la primera cosa que veía la gente a su llegada en barco al puerto de Nueva York para iniciar una nueva vida en América.

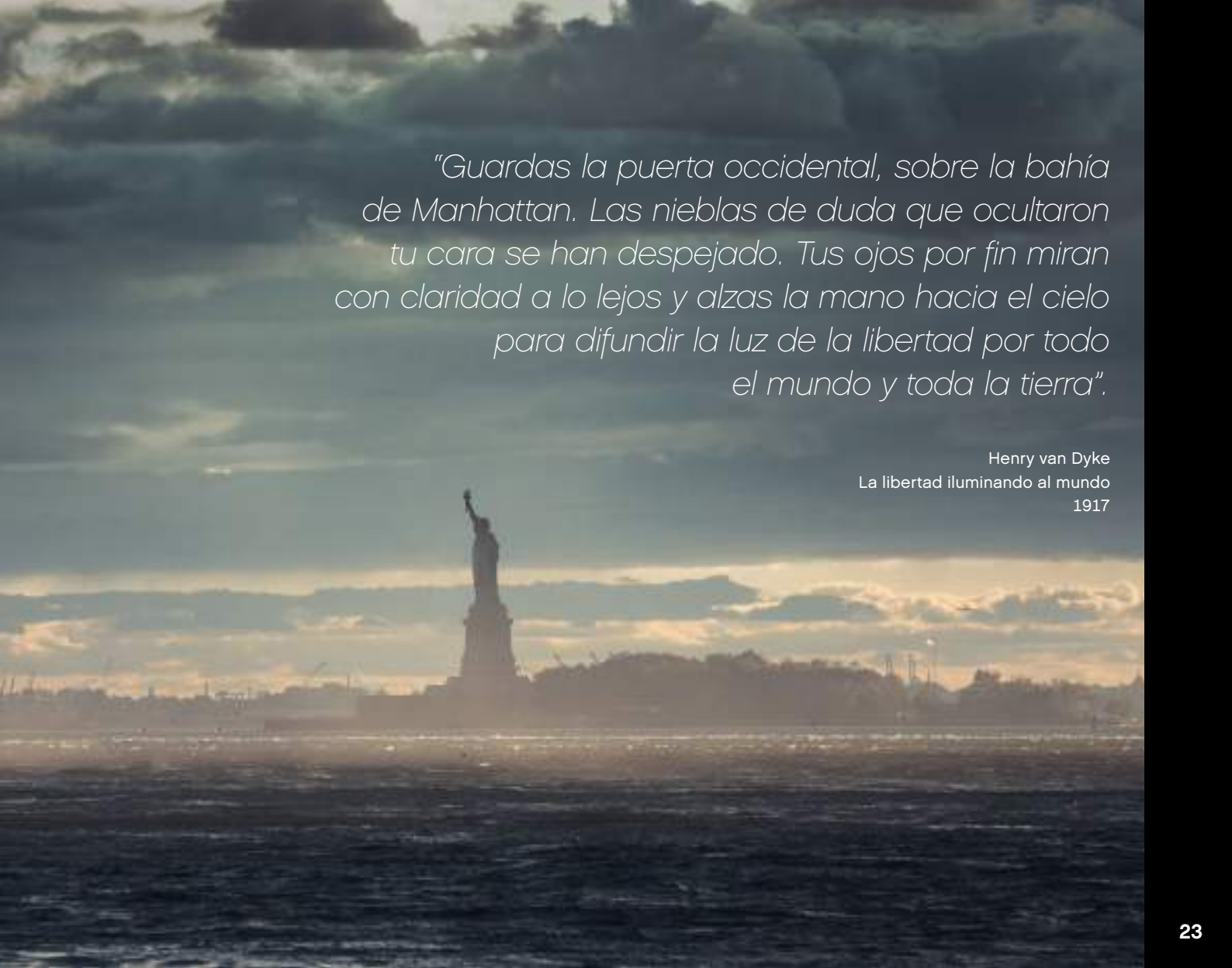

A photograph of the Statue of Liberty in New York Harbor, silhouetted against a dramatic sunset sky with dark, heavy clouds. The water in the foreground is dark and textured. The overall mood is contemplative and powerful.

“Guardas la puerta occidental, sobre la bahía de Manhattan. Las nieblas de duda que ocultaron tu cara se han despejado. Tus ojos por fin miran con claridad a lo lejos y alzas la mano hacia el cielo para difundir la luz de la libertad por todo el mundo y toda la tierra”.

Henry van Dyke
La libertad iluminando al mundo
1917

El regalo

Édouard de Labouaye fue un destacado pensador político francés y un sólido partidario del presidente Abraham Lincoln durante la Guerra Civil Americana. En 1865, propuso crear un monumento para que el pueblo de Francia se lo regalara a los Estados Unidos con motivo de la reciente victoria de la Unión en la Guerra Civil y la abolición de la esclavitud.

Diez años más tarde, con ayuda del escultor Frédéric-Auguste Bartholdi, Labouaye hizo realidad su propuesta y fundó la Unión Francoamericana para recaudar los fondos necesarios para el proyecto. Se esperaba que el pueblo francés financiara la estatua propuesta, hoy llamada “La libertad iluminando al mundo”, y que el pueblo americano pagara el pedestal.

En uno de sus viajes a los Estados Unidos para contribuir a la recaudación de fondos, el escultor Bartholdi se



dio cuenta de que Nueva York era la puerta de entrada a América y divisó un lugar perfecto para la estatua. La isla de Bedloe se podía ver desde todos los buques que llegaban al puerto de la ciudad o partían de él, y Bartholdi imaginó su estatua sobre el fuerte Wood, que ya estaba construido en la isla.

El proyecto pronto capturó la imaginación de muchos a ambos lados del Atlántico y, cuando los franceses recaudaron sus 400,000 francos, comenzó por fin la construcción de la estatua.

*"[...] un manantial de luz perforará la oscuridad
[...] hasta que Libertad ilumine al mundo".*

Presidente Grover Cleveland
Discurso de inauguración de la Estatua de la Libertad
28 de octubre de 1886







Del sueño a la realidad

En 1876, artesanos franceses comenzaron a forjar los diferentes elementos de la estatua. Aunque el diseño exterior y los materiales estaban decididos, el verdadero desafío residía en la estructura interna.

Bartholdi recurrió al arquitecto e ingeniero estructural francés Gustave Eiffel, quien propuso la creación de un pilón central de 28 m al que podrían conectarse vigas asimétricas. Después podrían atornillarse barras planas de metal a las vigas para sostener la piel de cobre de la estatua. Eiffel se decidiría por el mismo método de construcción alrededor de un pilón que usó para su famosa Torre Eiffel, completada en 1889.

La estatua entera se fabricó en París entre 1881 y 1884. Llegó a Nueva York con bombos y platillos a bordo del barco francés *Isère* el 17 de junio de 1885. Una vez completado el pedestal en 1886, ensamblar la estatua, de 46 m de altura, fue bastante rápido. La última sección fue el rostro de la Estatua de la Libertad, que permaneció cubierto hasta la inauguración oficial, el 28 de octubre de 1886. Ni la lluvia ni la niebla impidieron que más de un millón de neoyorquinos presenciaran con júbilo la presentación de la nueva estatua.

“¡Guárdense, antiguas tierras, su ilustre pompa!”, grita con sus silenciosos labios. “Denme a sus rendidos, a sus pobres, a sus masas hacinadas anhelando respirar en libertad. El miserable rechazo de sus orillas repletas. Envíenme a los que no tienen techo y a los que arrojó la tempestad. ¡Levanto mi lámpara junto a la puerta dorada!”

Emma Lazarus
El nuevo coloso
1883

Un icono universal

La Estatua de la Libertad estaba destinada a convertirse en un símbolo universal de iluminación y libertad. La figura femenina de la túnica representa a Libertas, la diosa romana de la libertad, y aunque no se le ven claramente los pies, se encuentra entre un grillete roto y una cadena, con el pie derecho levantado, como alejándose de la opresión y la esclavitud. Las siete puntas de la corona representan los siete océanos y los siete continentes del mundo, respaldando con ello el concepto universal de libertad.

Con el tiempo, la estatua se convertiría también en un cálido símbolo de esperanza para las diferentes generaciones de inmigrantes que llegaron a los Estados Unidos. Entre 1886

y 1924, casi 14 millones de inmigrantes entraron en los Estados Unidos por Nueva York. A menudo, la Estatua de la Libertad era la primera cosa que veían al llegar en barco a su nuevo hogar.

El Servicio de Parques Nacionales de América se hizo cargo de la isla en 1937 y decidió transformar el área que rodea la estatua en un parque. La isla de Bedloe cambió su nombre por el de isla Libertad en 1957 para conmemorar la finalización de la obra. La estatua fue declarada Patrimonio de la Humanidad por la UNESCO en 1984 y sigue atrayendo unos 4 millones de visitantes al año.







Datos y cifras

Estilo	Escultura neoclásica
Materiales	Estatua: cobre y hierro Pedestal: piedra
Altura	Estatua: 46 m Con pedestal: 93 m
Peso	204 toneladas métricas
Inauguración	28 de octubre de 1886



LEGO.com/brickseparator

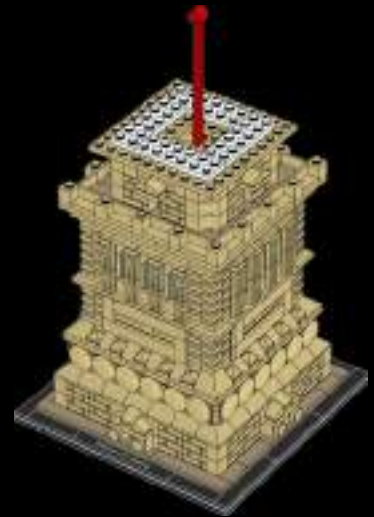
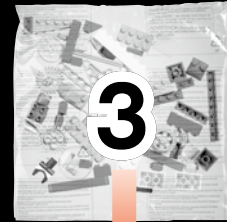
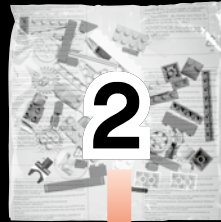
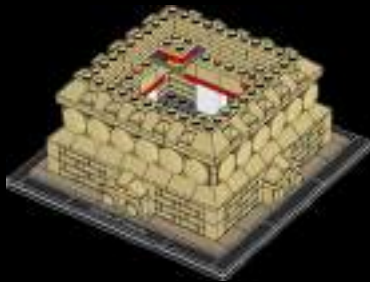

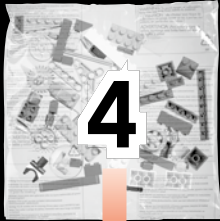

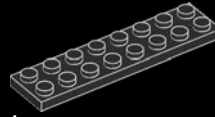
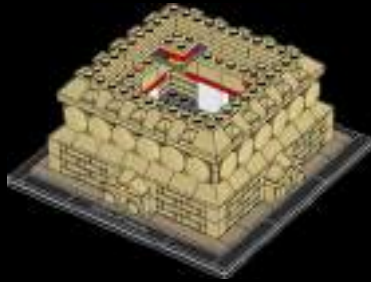

1x

1

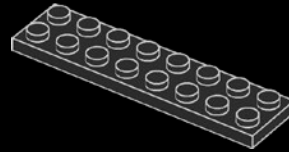

1x



1x

2

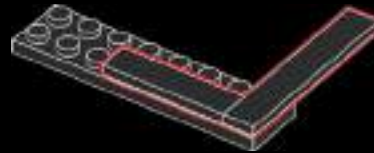

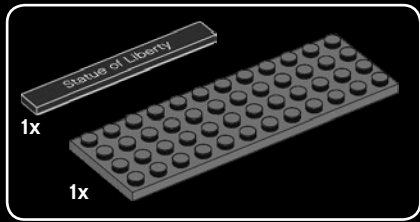

3

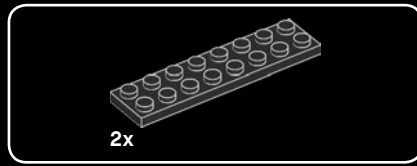
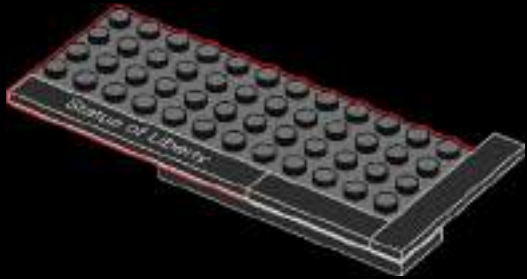

4

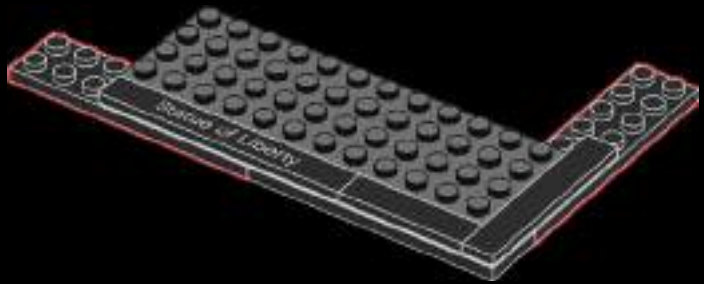

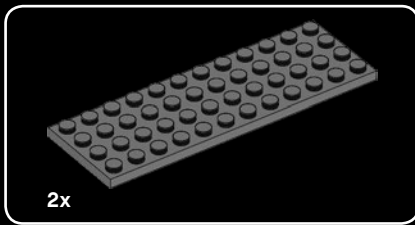

5

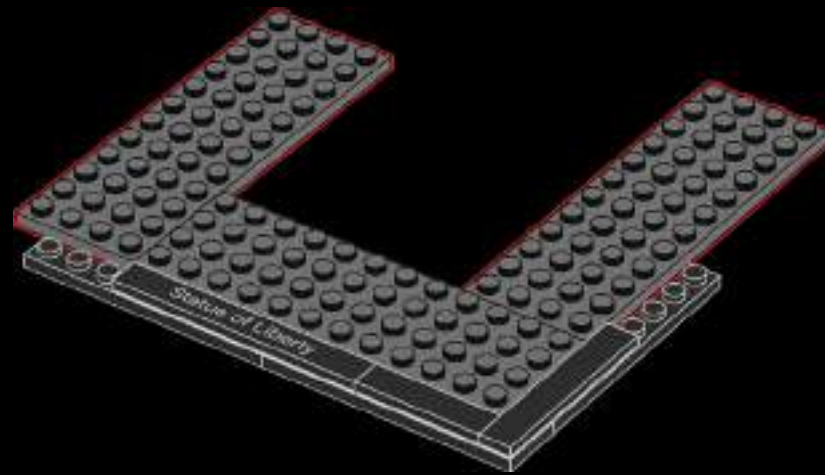

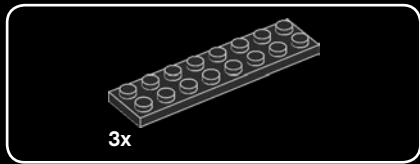

6

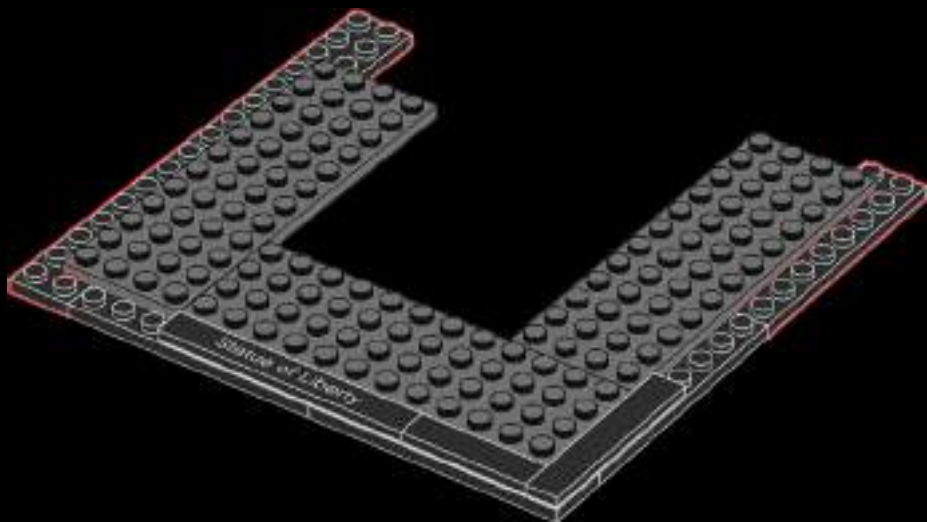

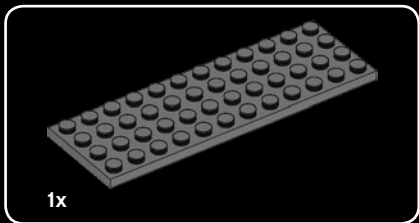

7

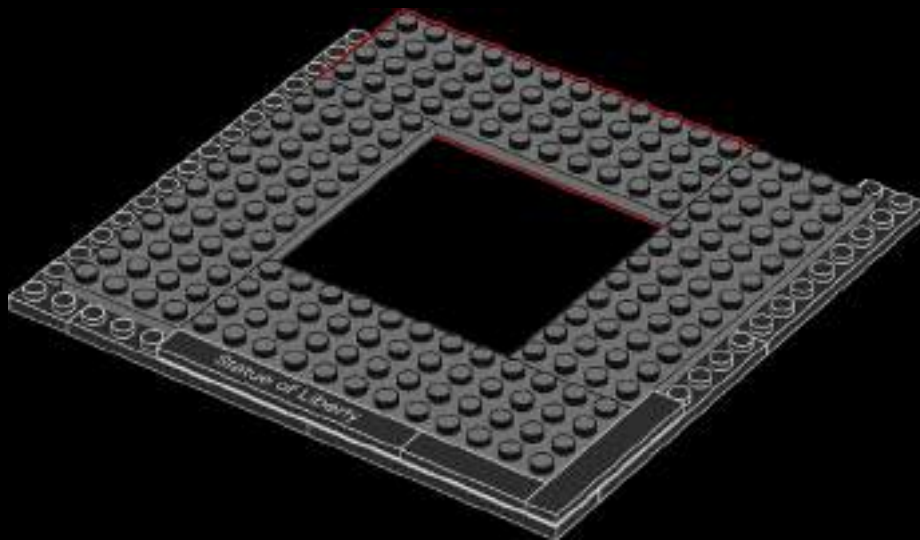

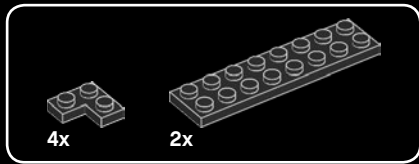

8

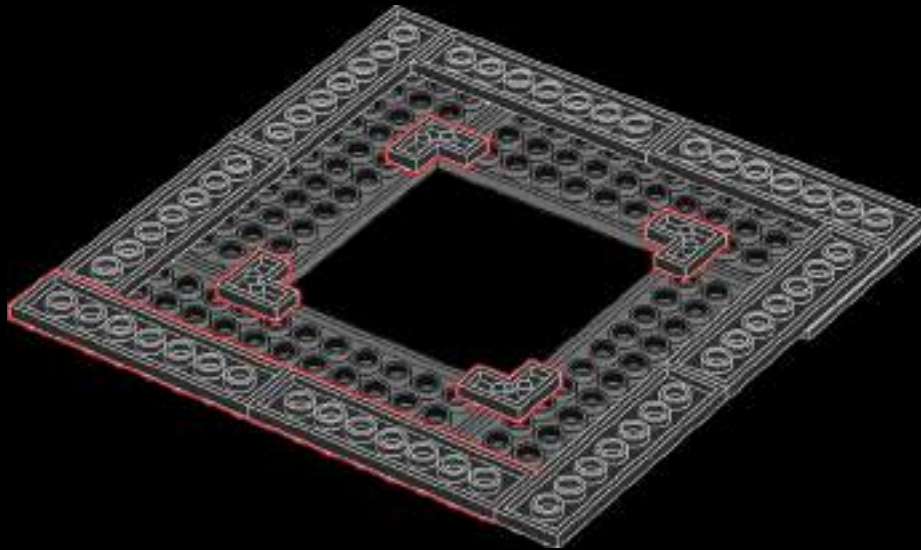
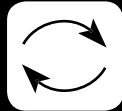

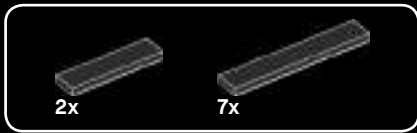

9

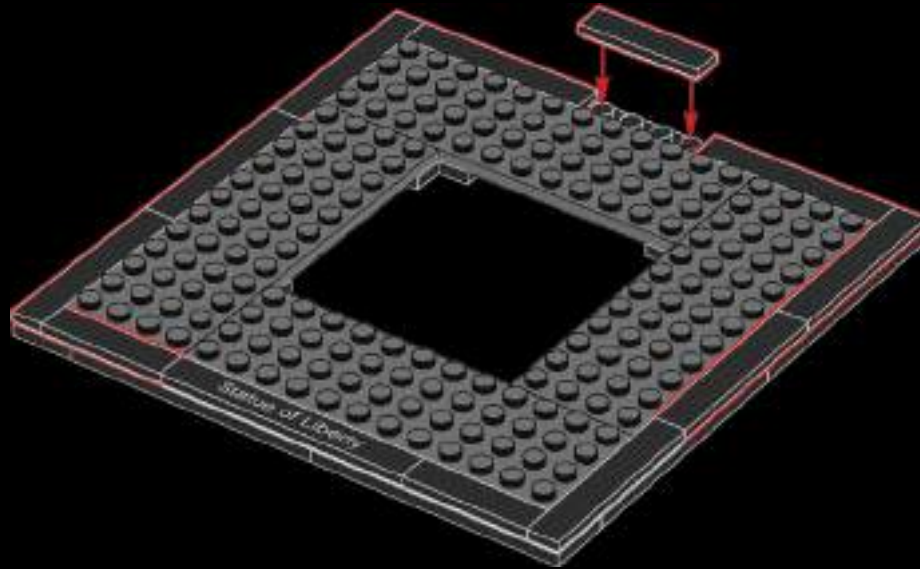
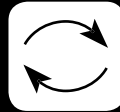

The Statue is thought to be hit by around 600 bolts of lightning every year.
On estime que la statue de la Liberté est frappée par environ 600 éclairs chaque année.
Se cree que la estatua es alcanzada por unos 600 rayos cada año.



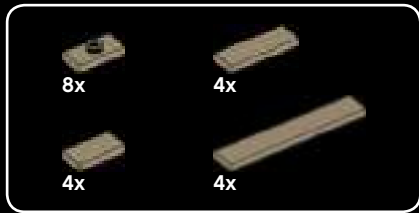

10

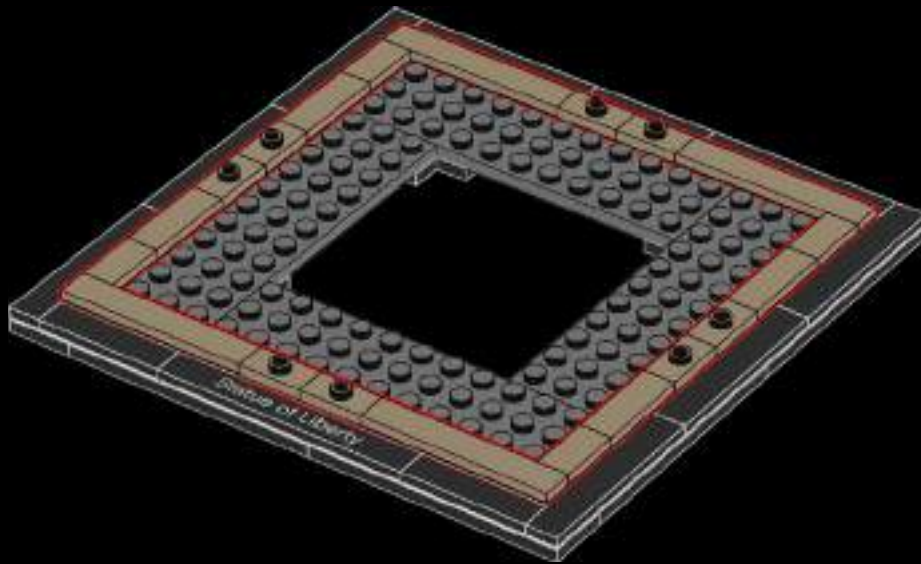

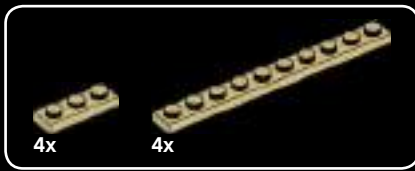

11

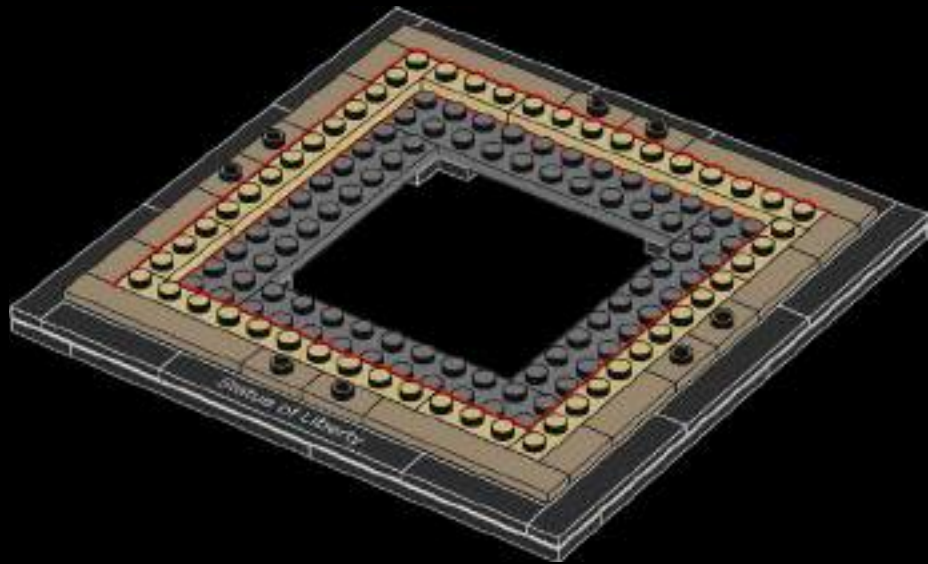



12x



16x

12

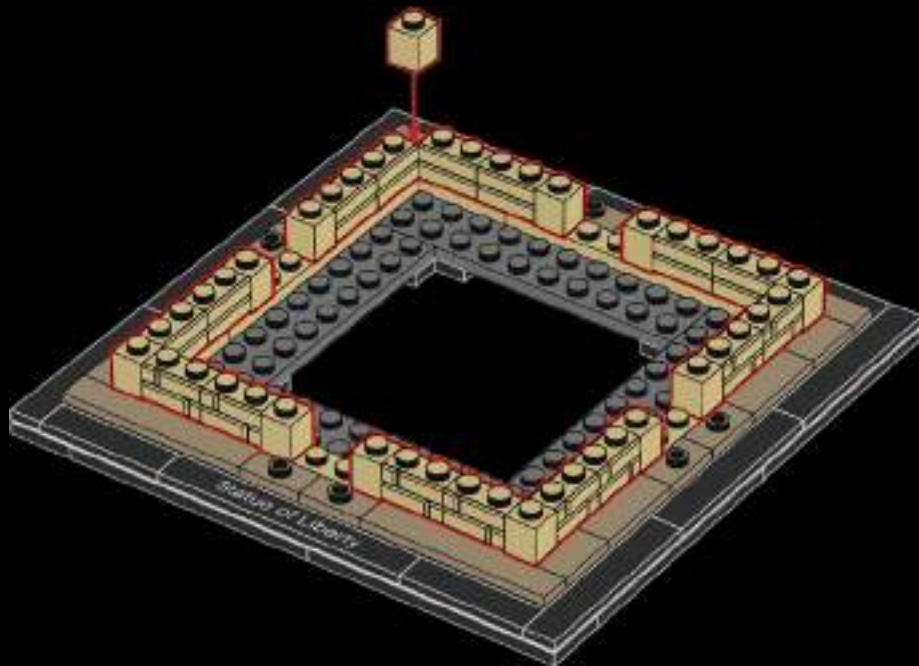

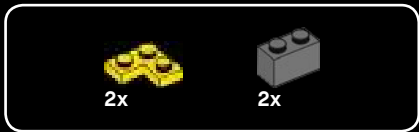

13

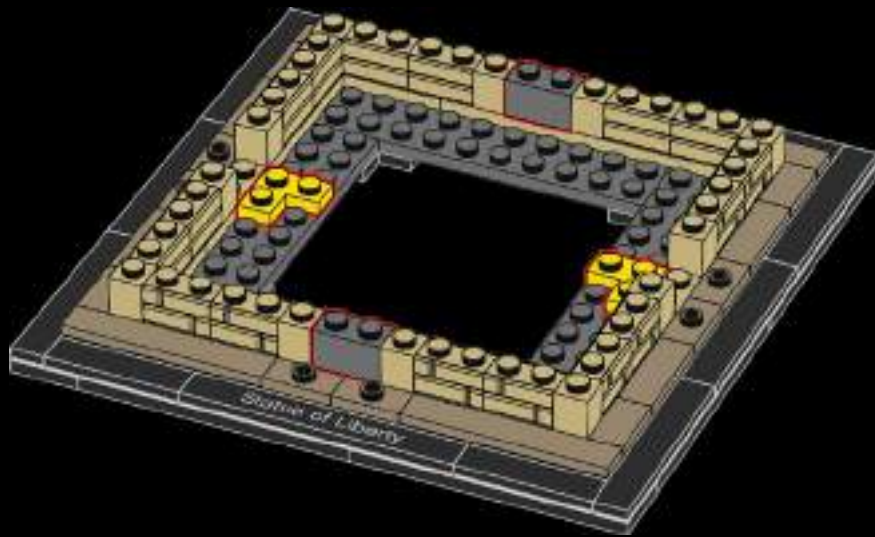

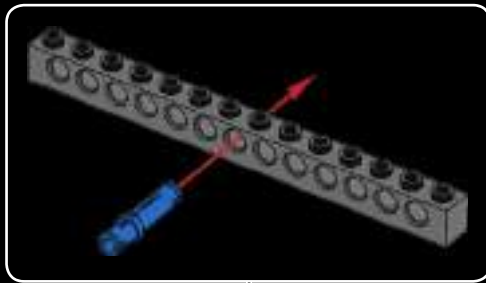
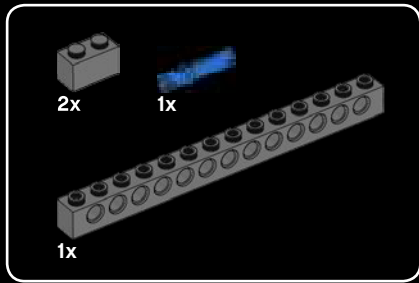

14

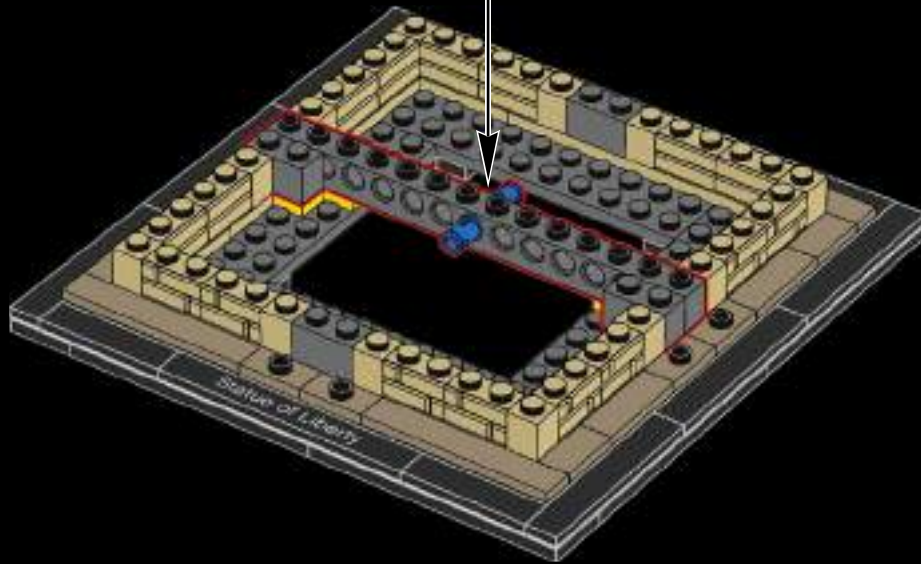

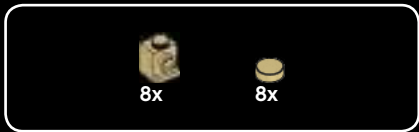

15

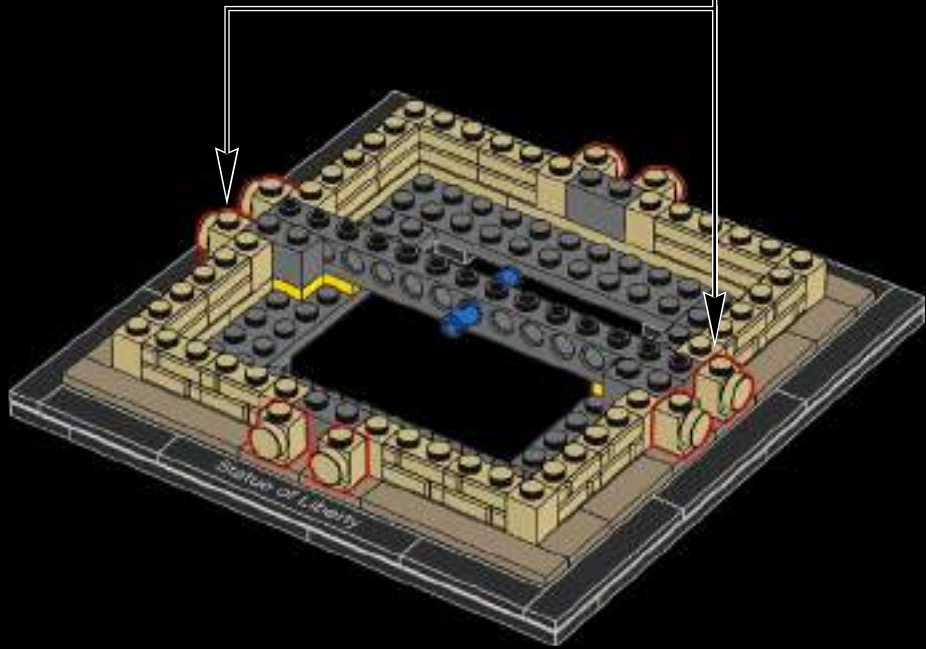
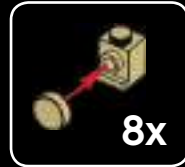

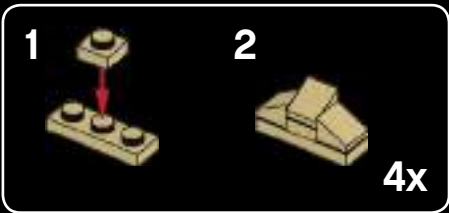

16

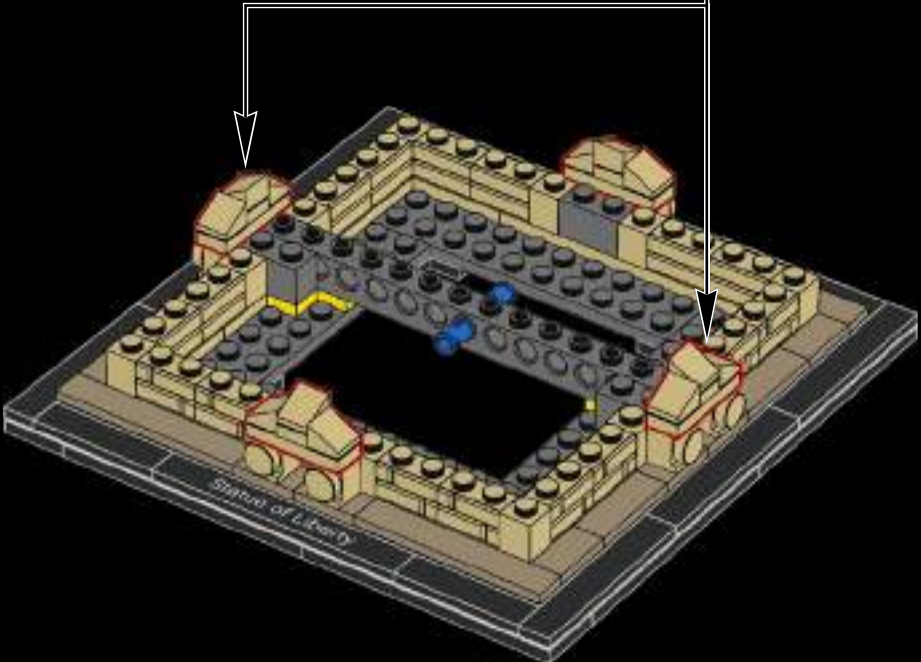

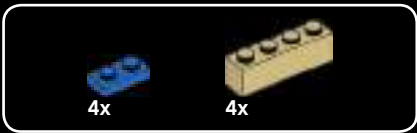

17

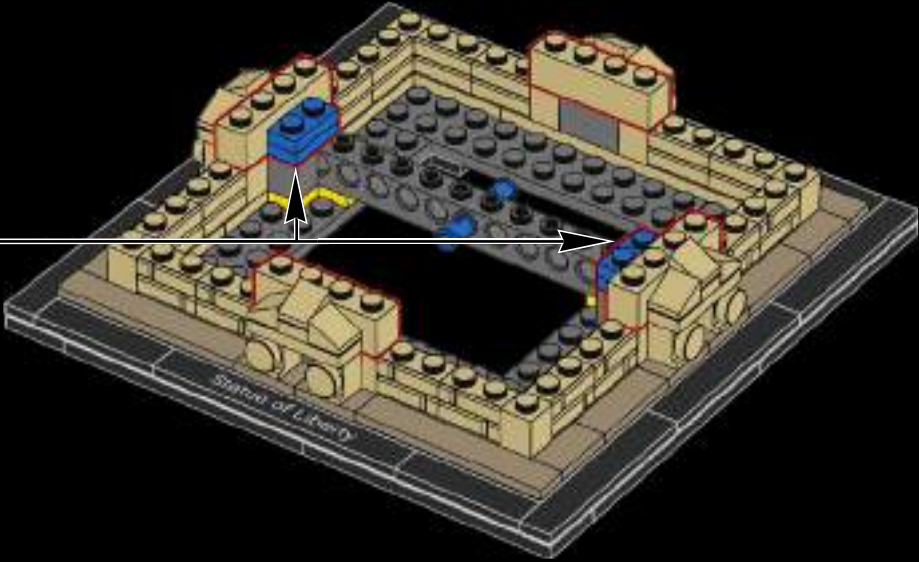
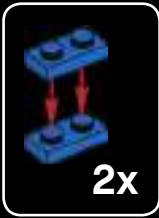



4x



16x

18

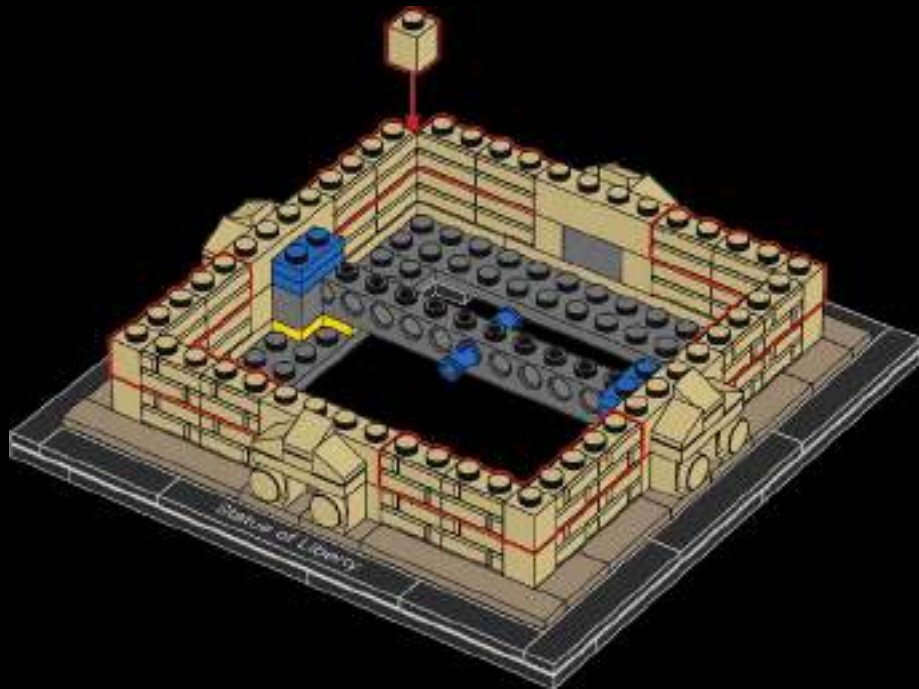



19

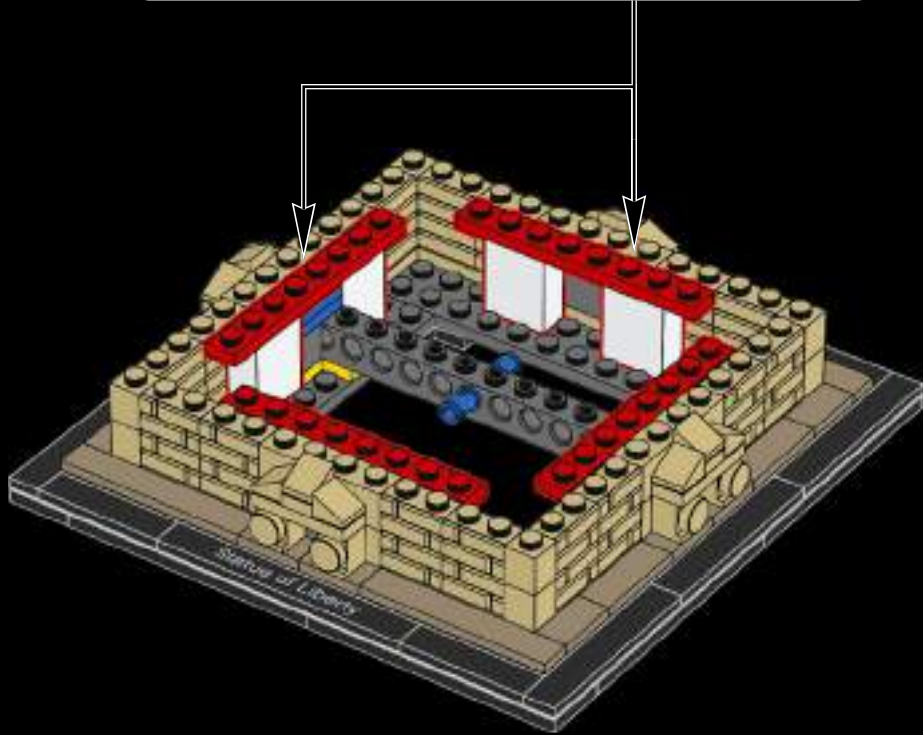
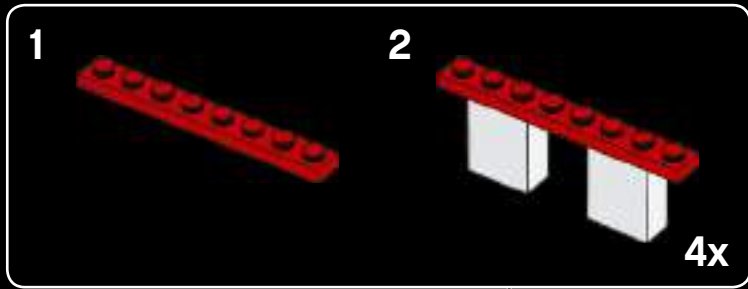



20

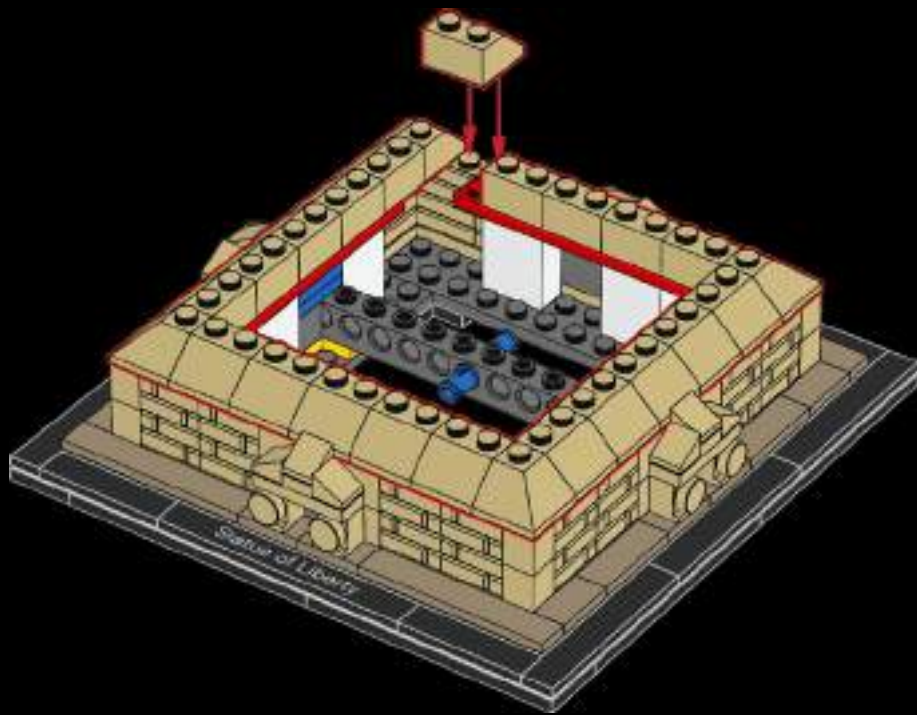



21

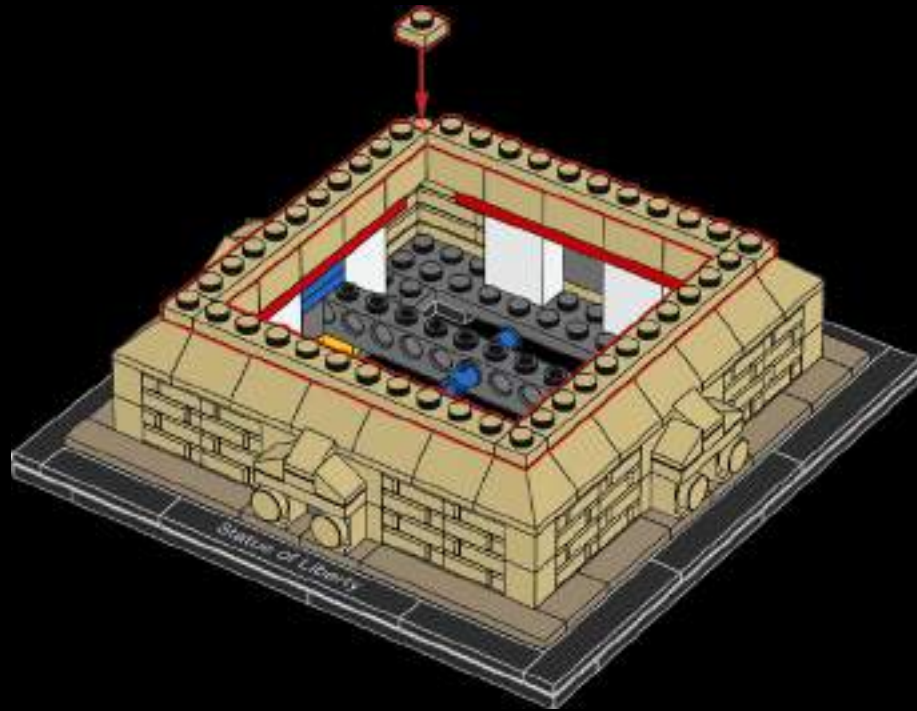

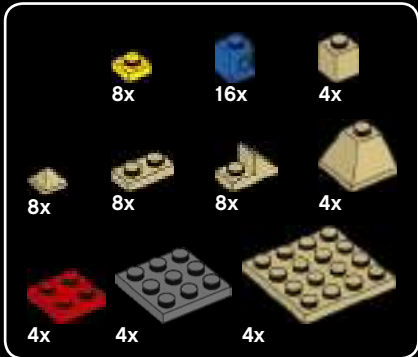

22

1



2

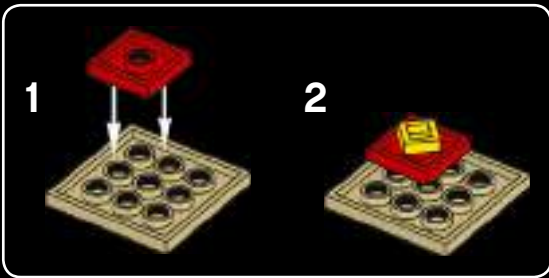

3



4



5

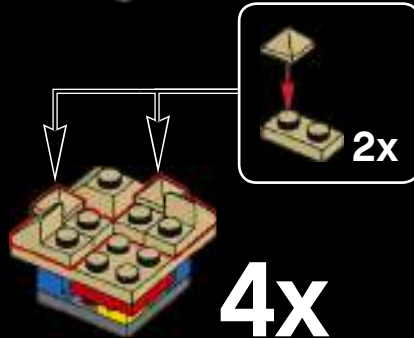

4x

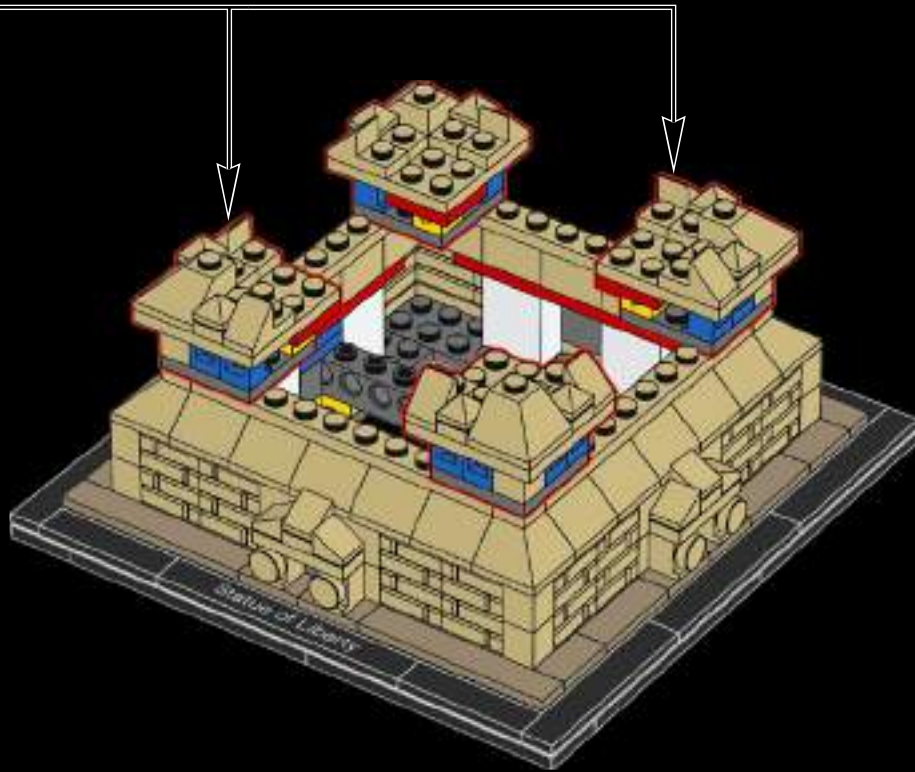

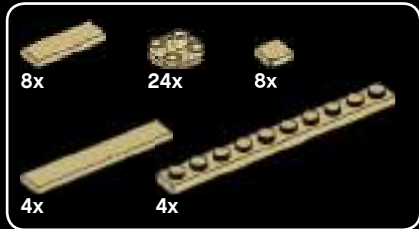

23

1



2



3



4



4x

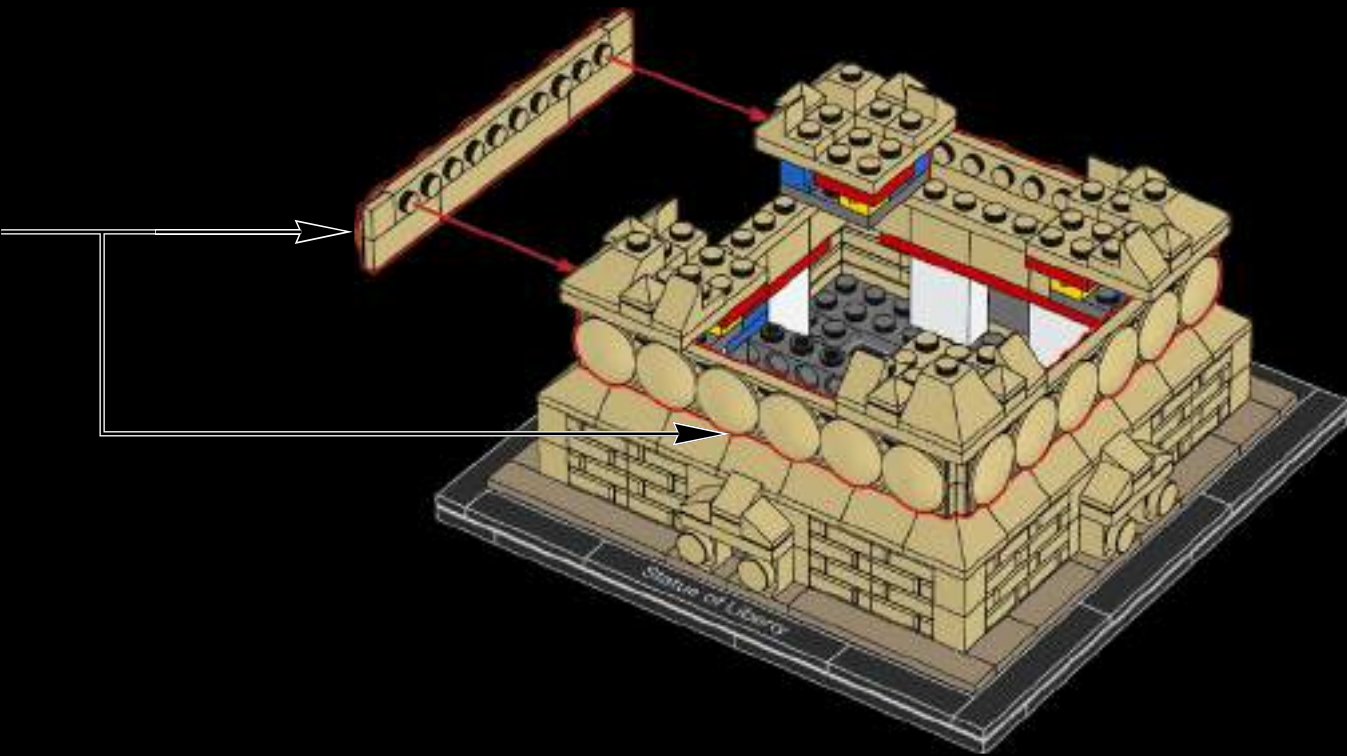

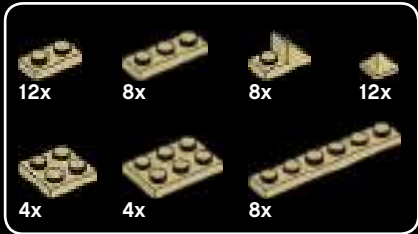

24

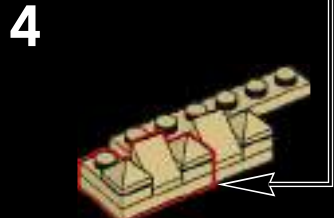
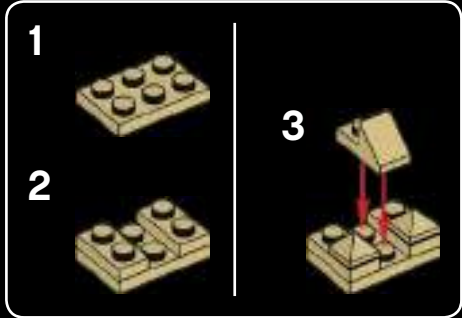

5



6

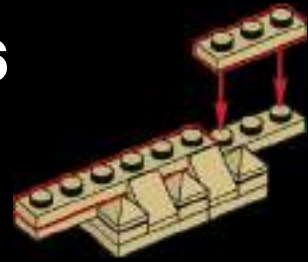

4x

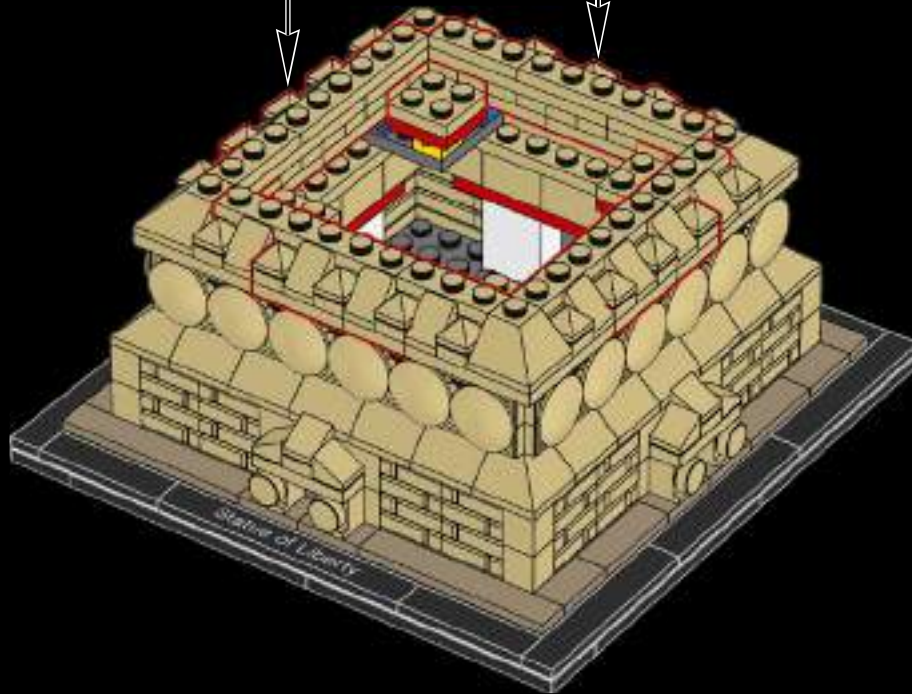

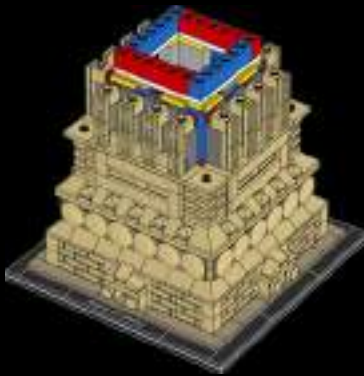
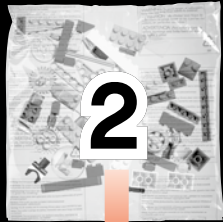

4x



8x



16x



4x



8x



4x



8x



8x



8x

25

1

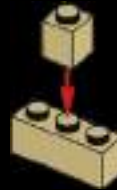

2

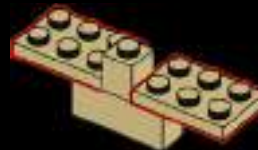

3

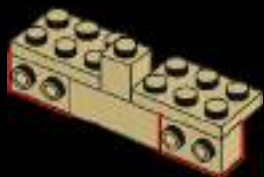

4

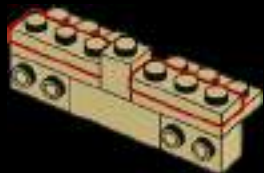

5

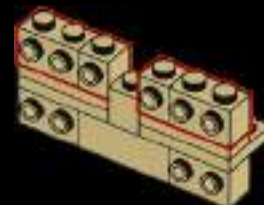

6

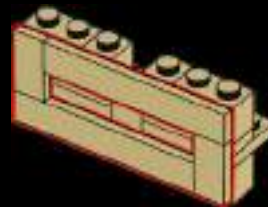

4x
61

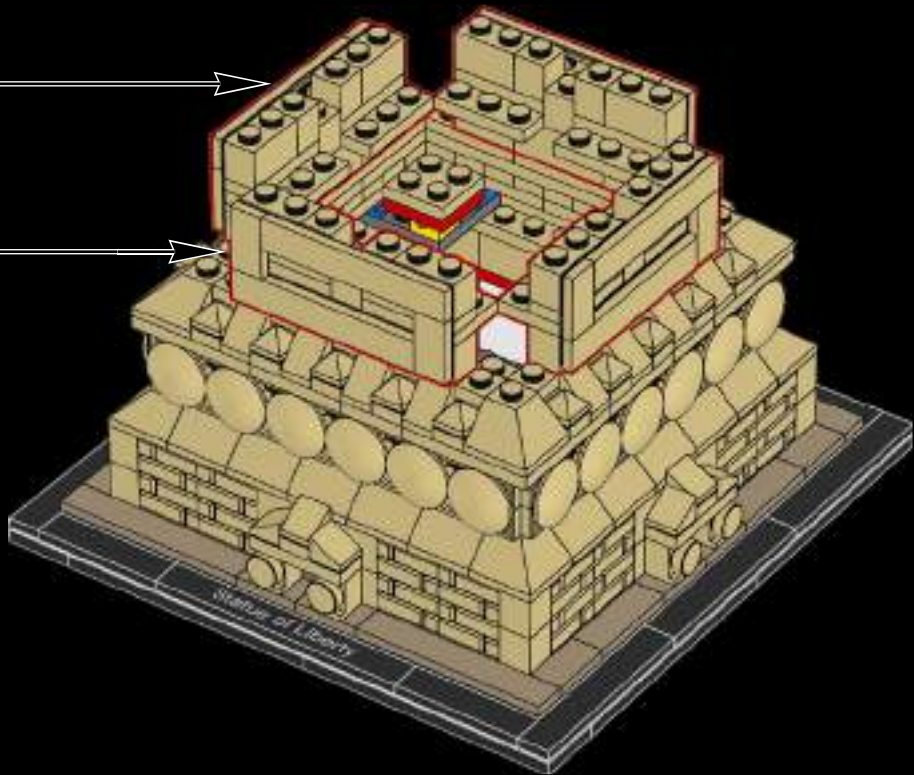

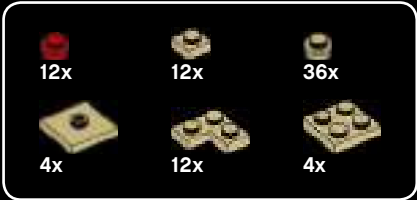

26

1



2



3



4



4x

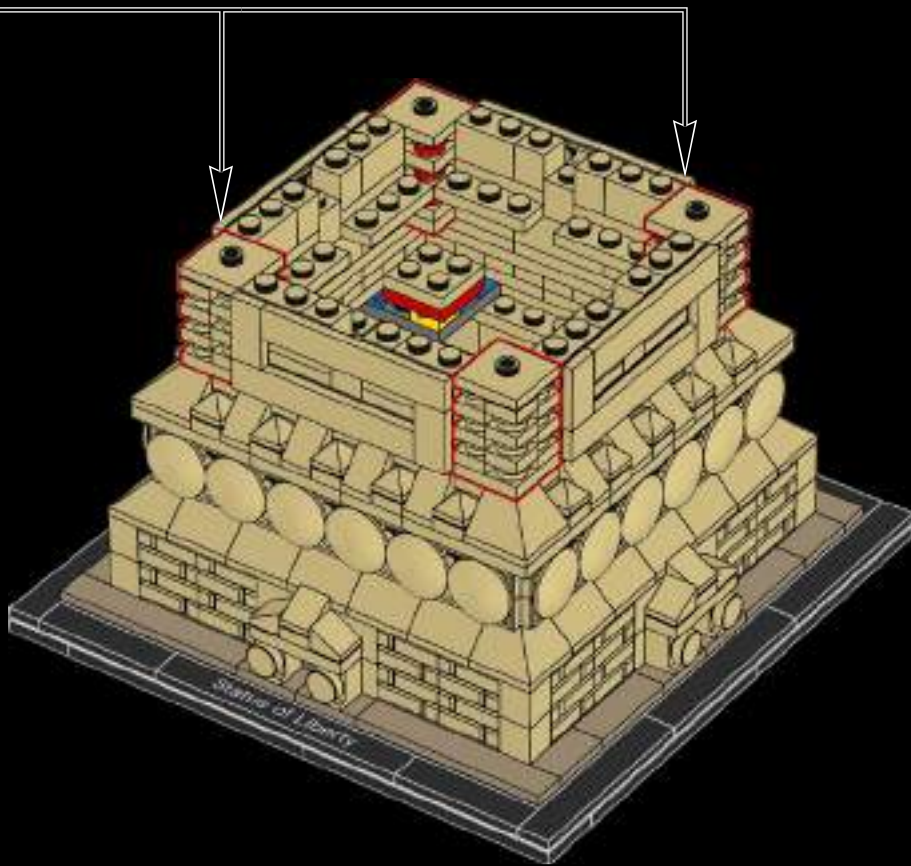



27

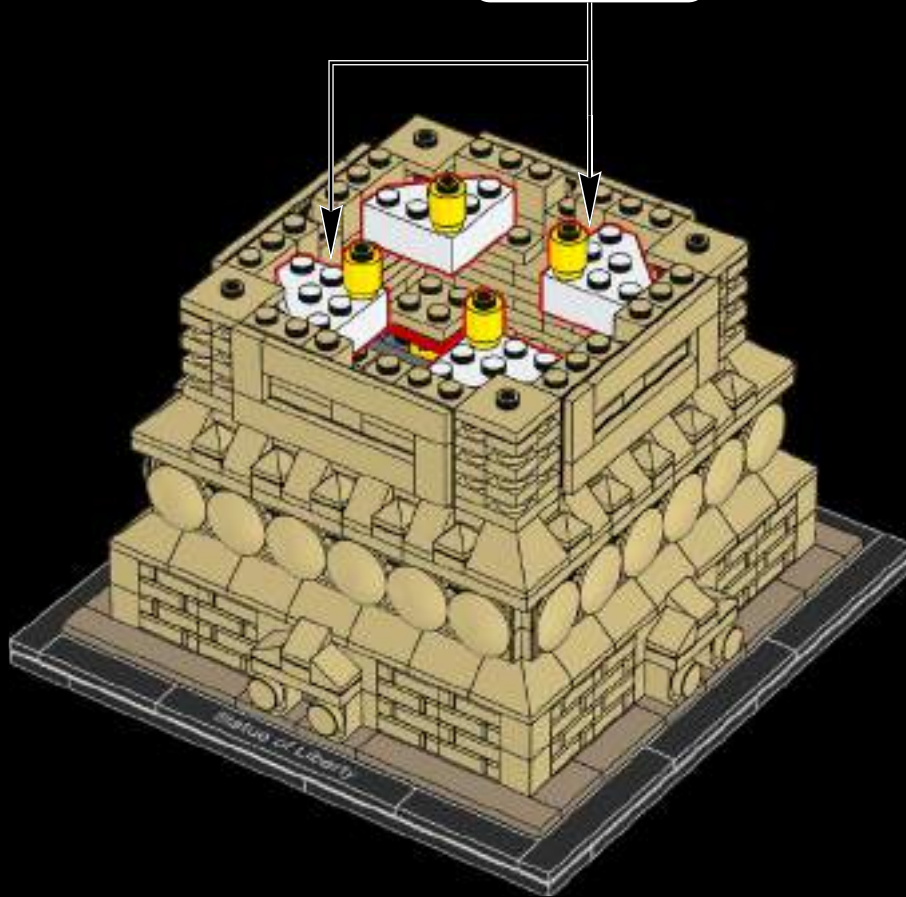
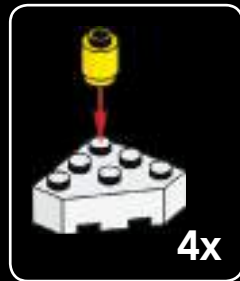

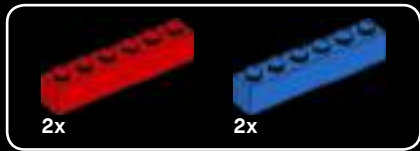

28





29

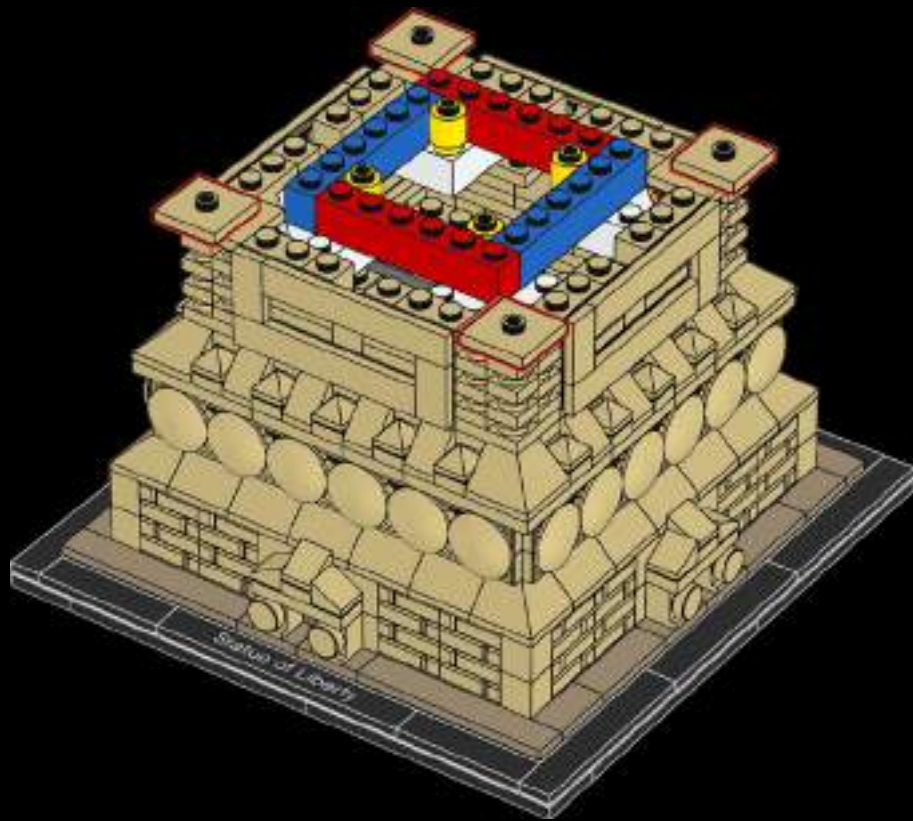



8x

30

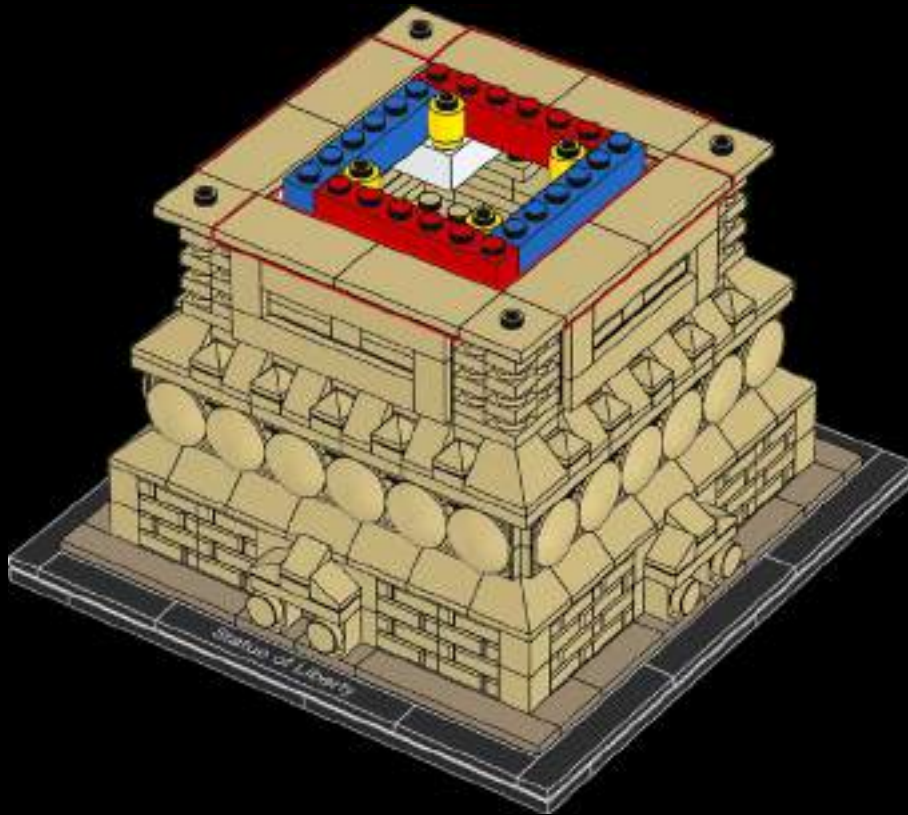

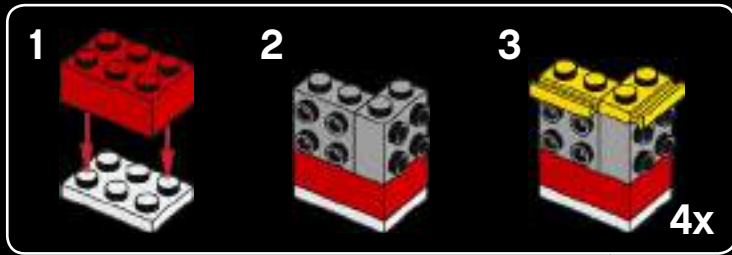
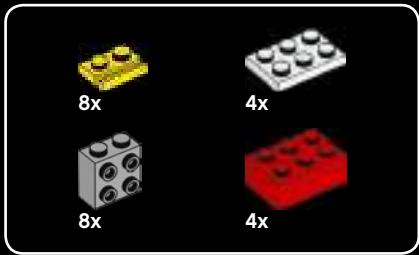

31

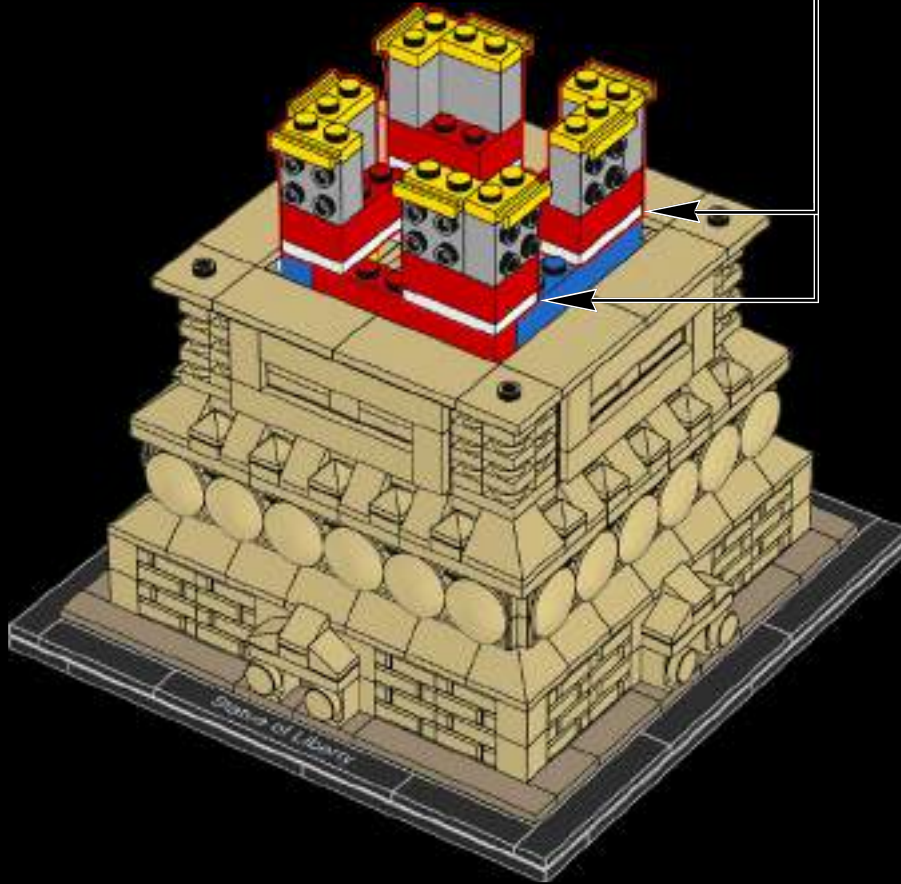



4x

32





33

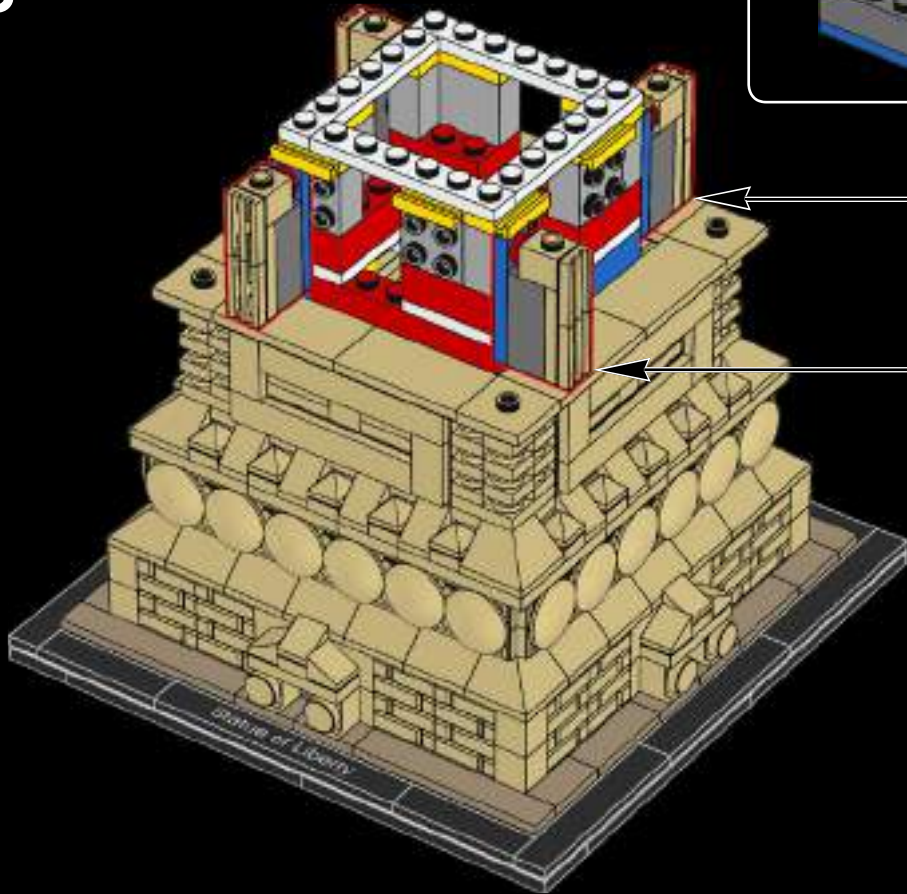
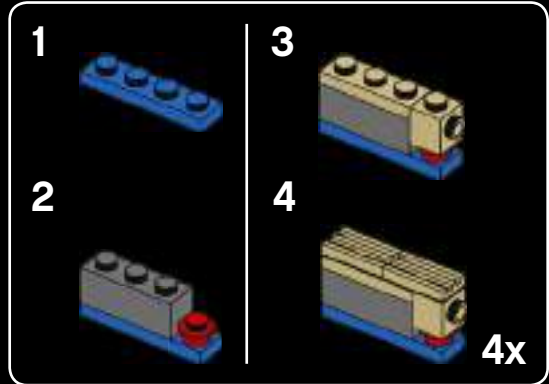

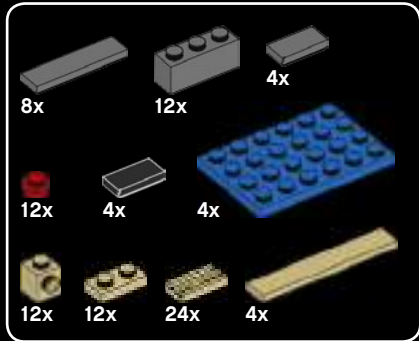

34

1



2

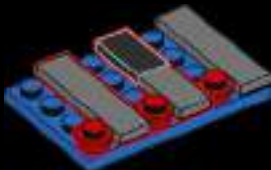

3

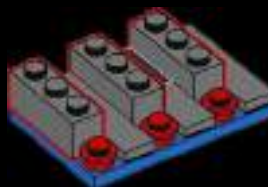

4

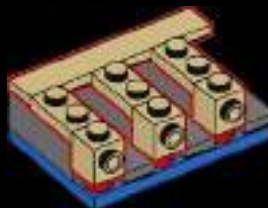

5

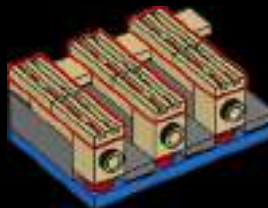

4x

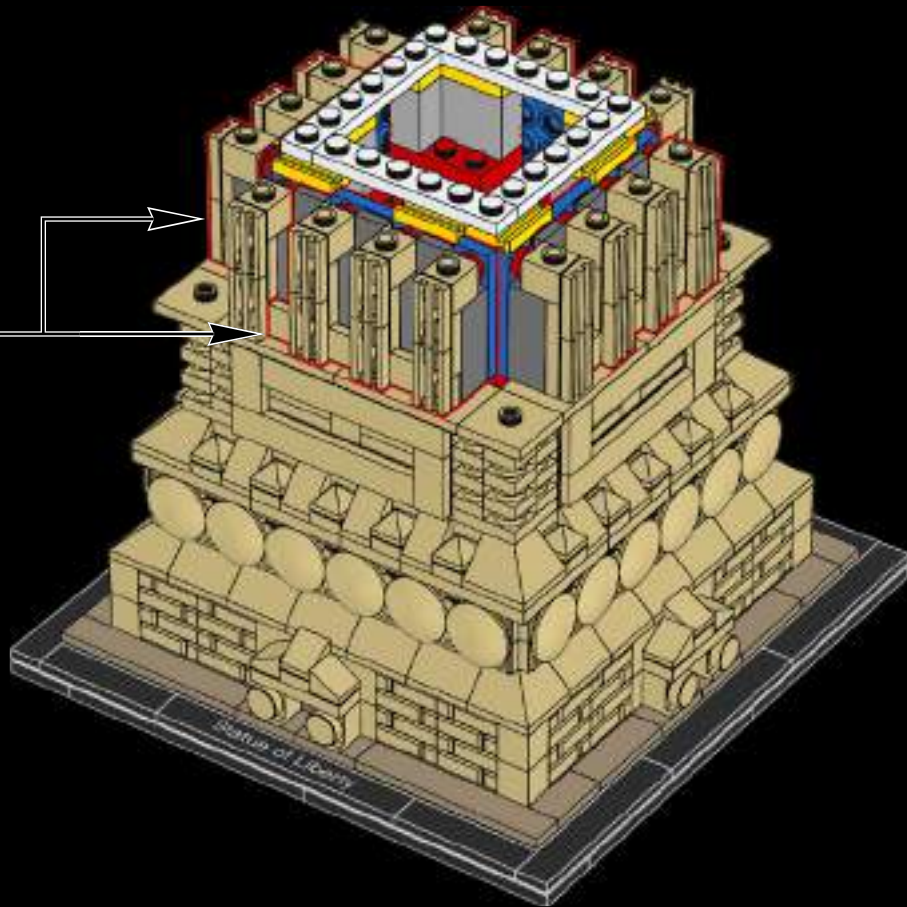

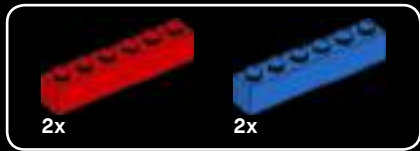

35

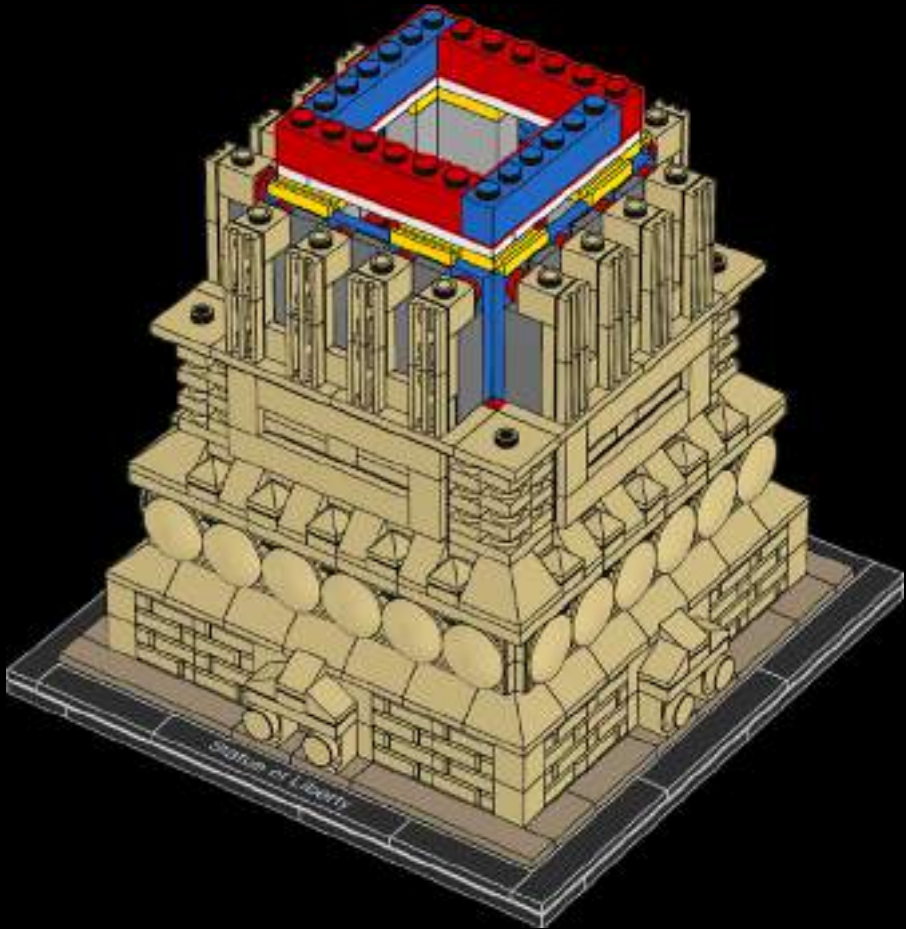

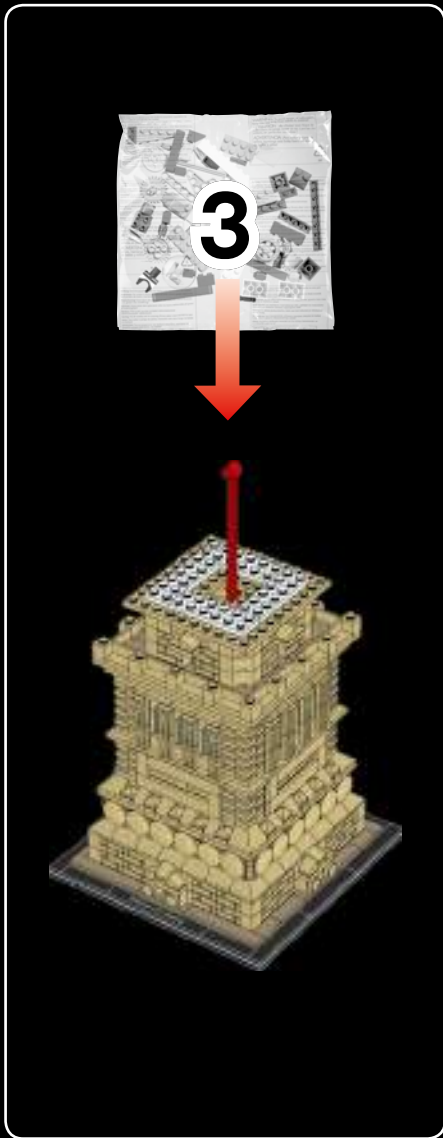

36

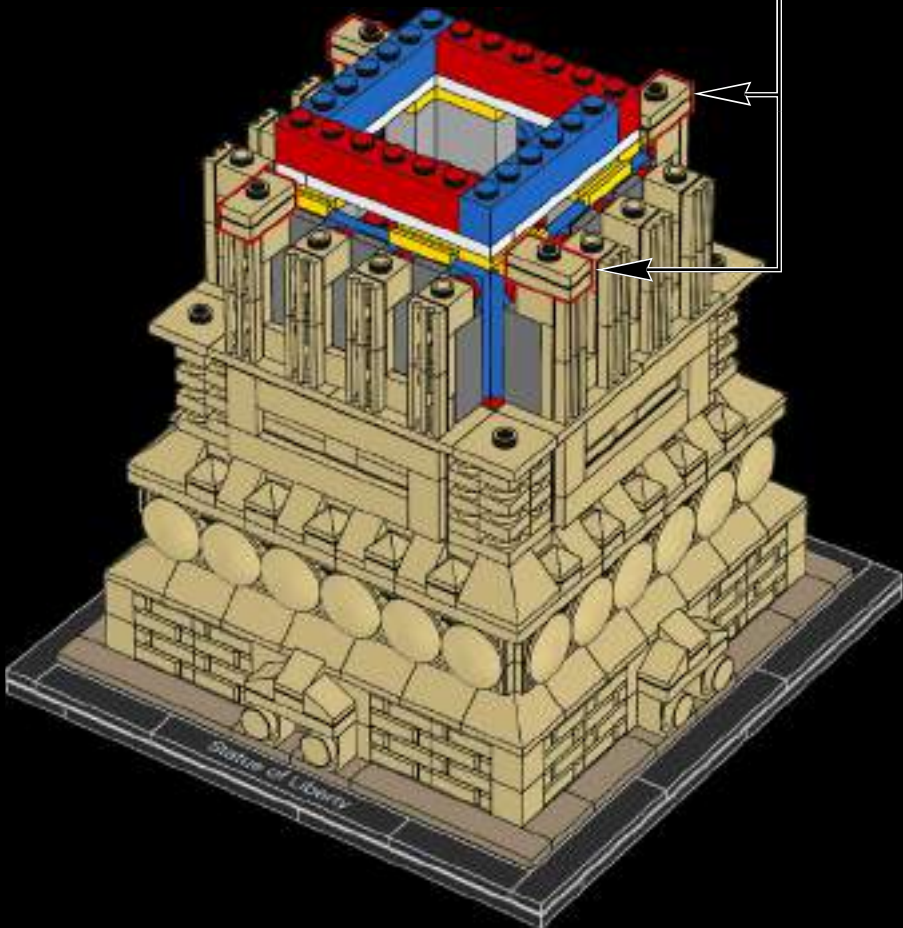
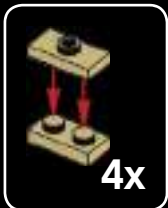



37

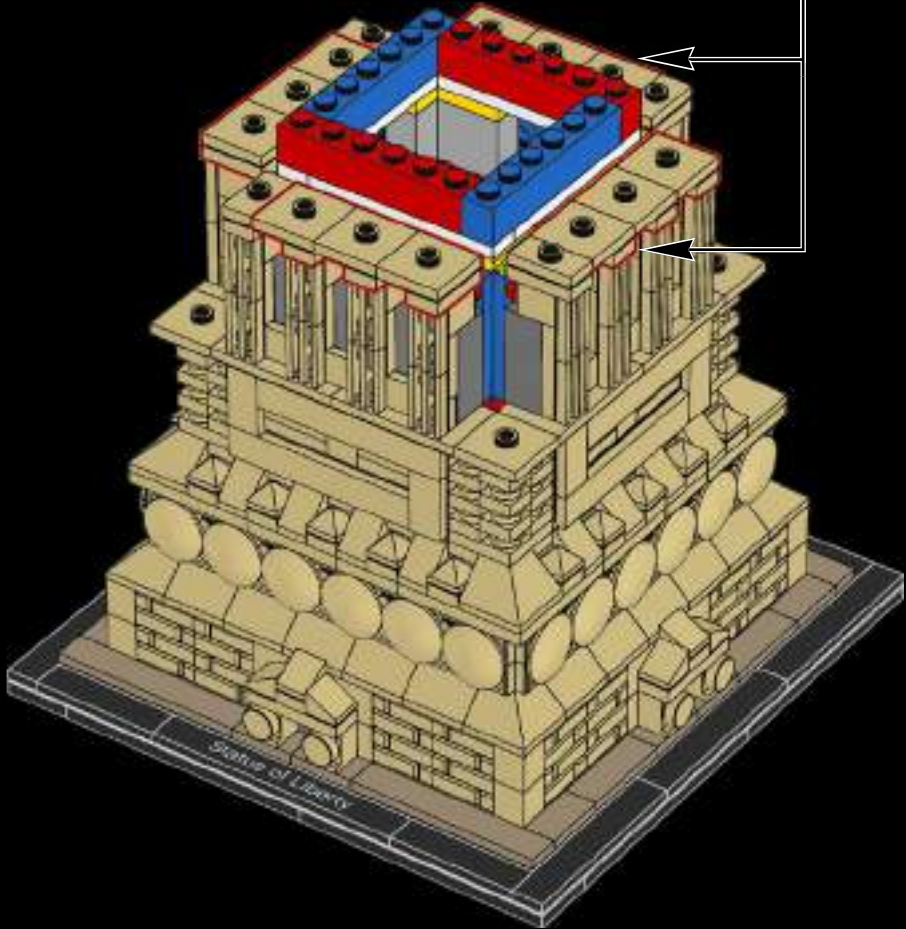



38

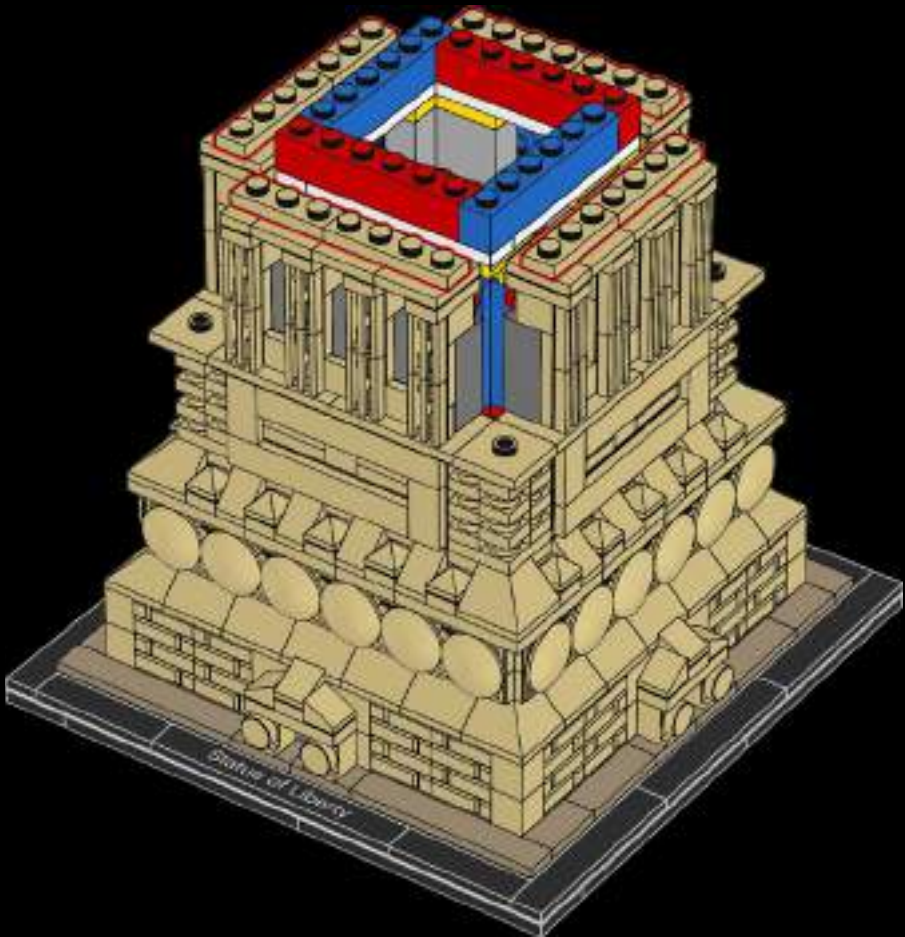

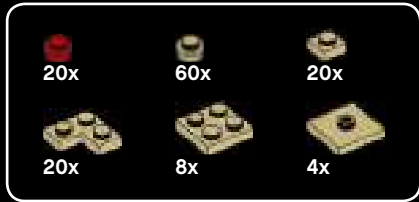

39

1



2



3



4



4x

In high winds of 50 mph (80 kph) or more, the Statue can sway by up to 3 in. (7.6 cm).
Par vents forts de 80 km/h ou plus, la statue peut osciller jusqu'à 7,6 cm.
Con vientos fuertes de 80 km/h o más, la estatua puede oscilar hasta 7,6 cm.

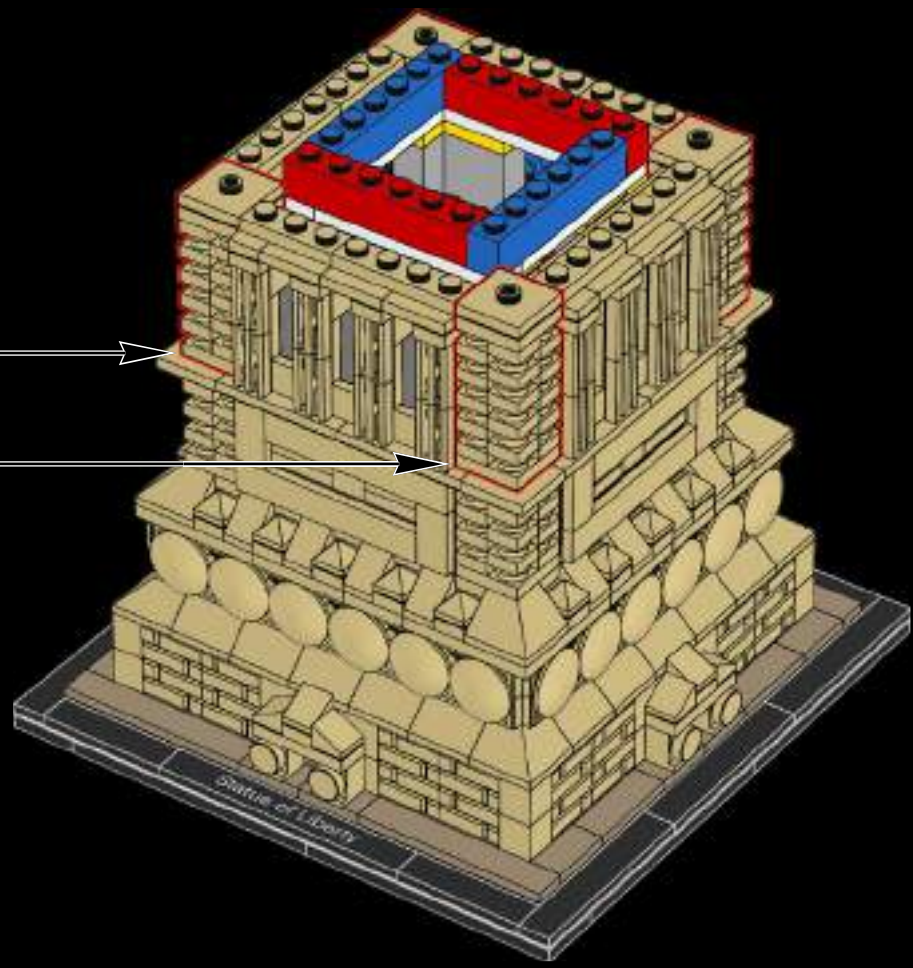

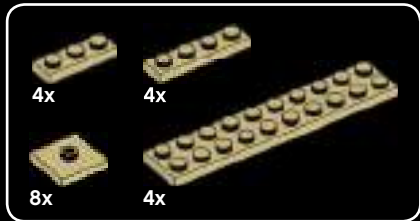
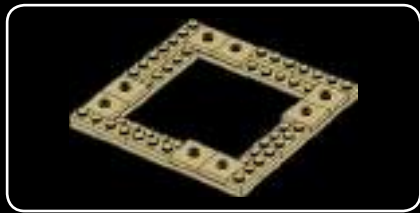

40

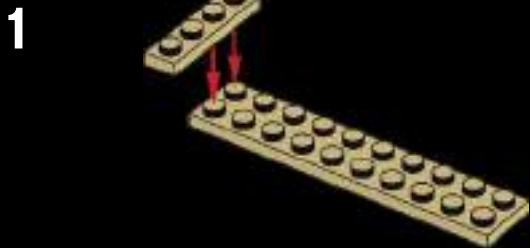

2



3

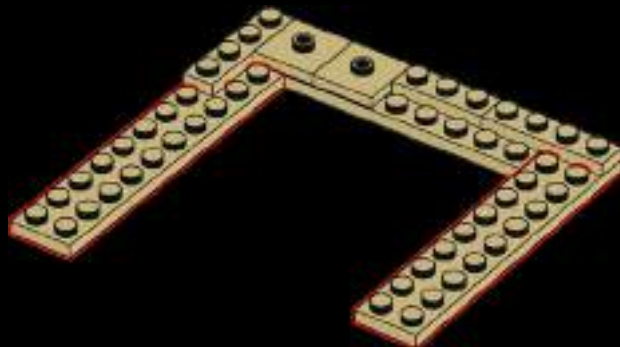

4

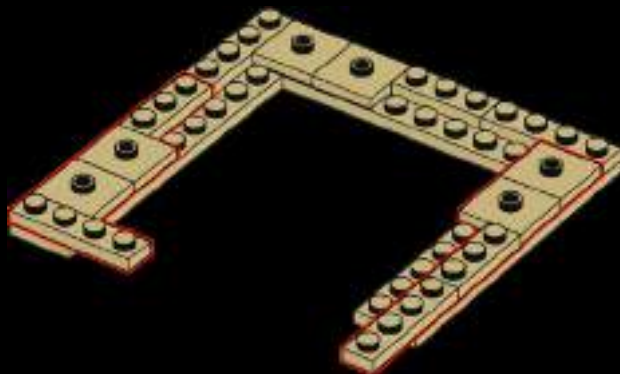

1



2



5

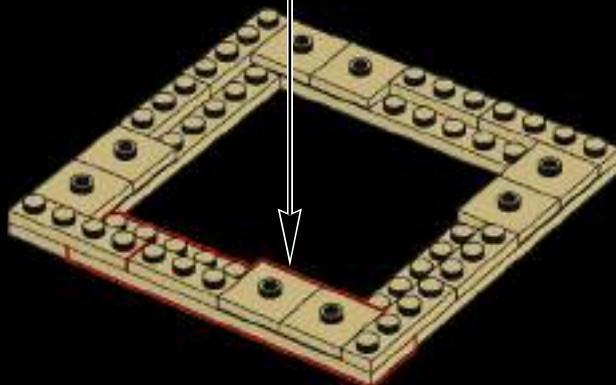

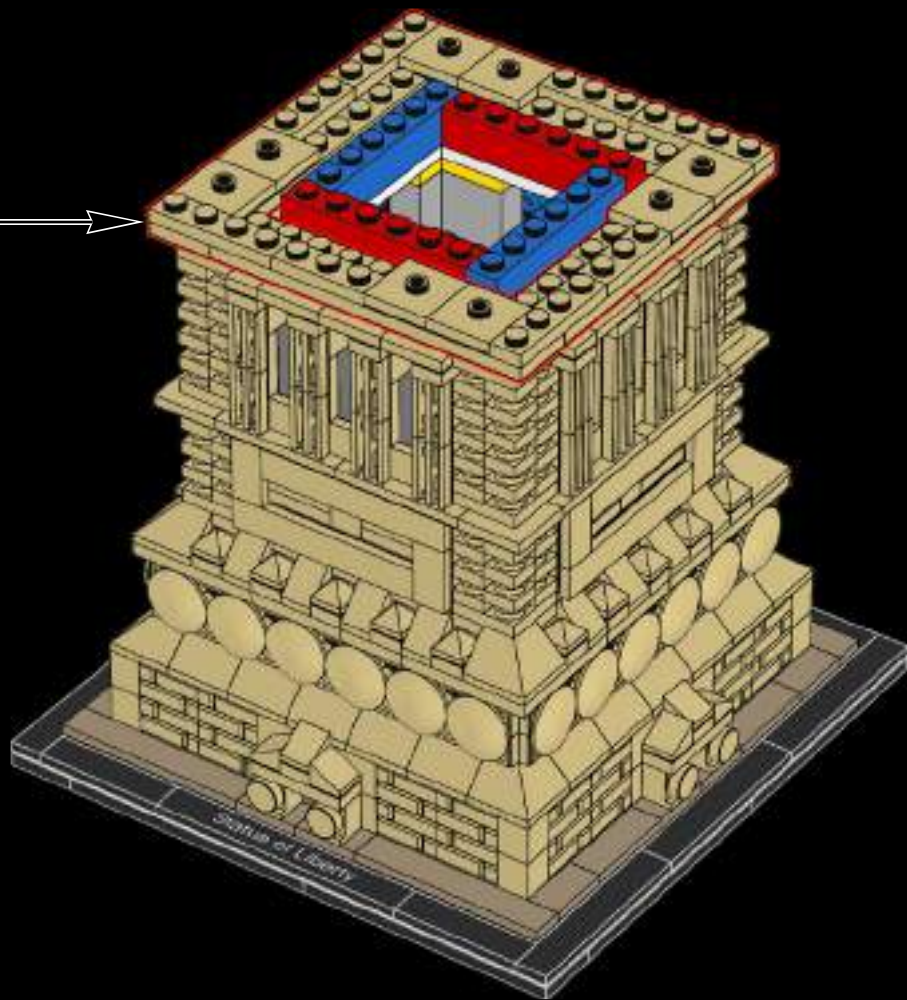



41

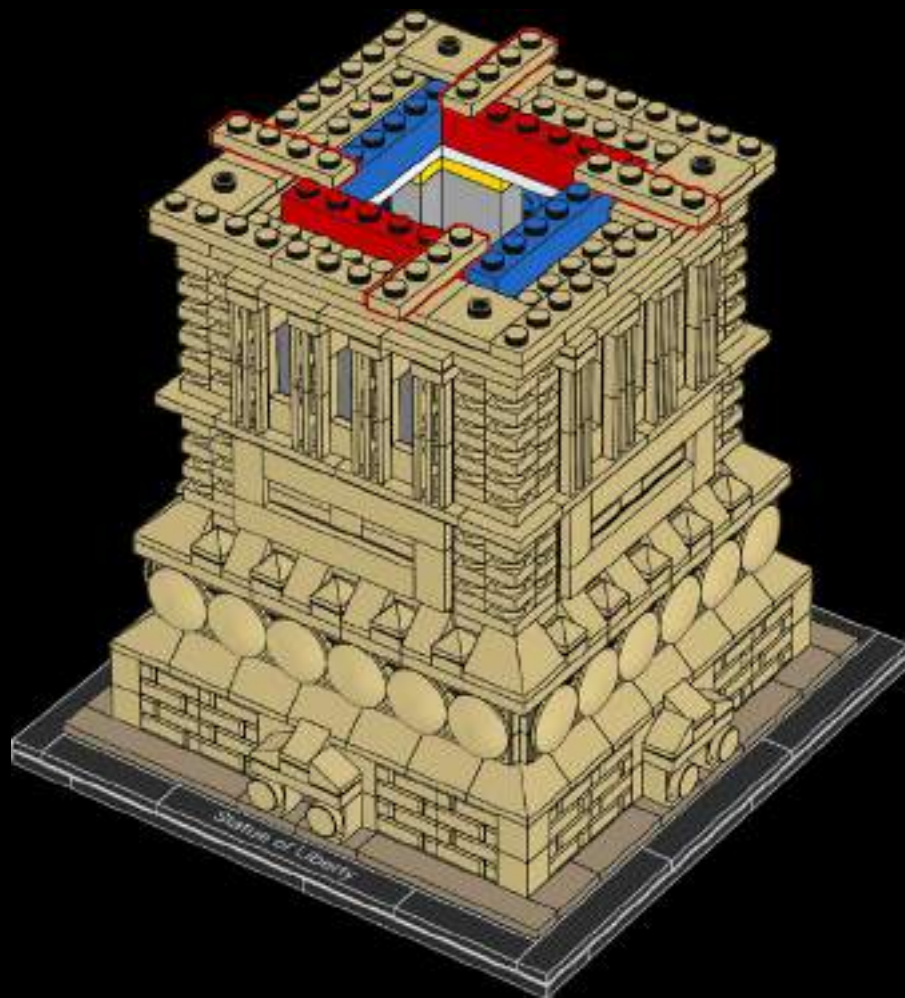



42

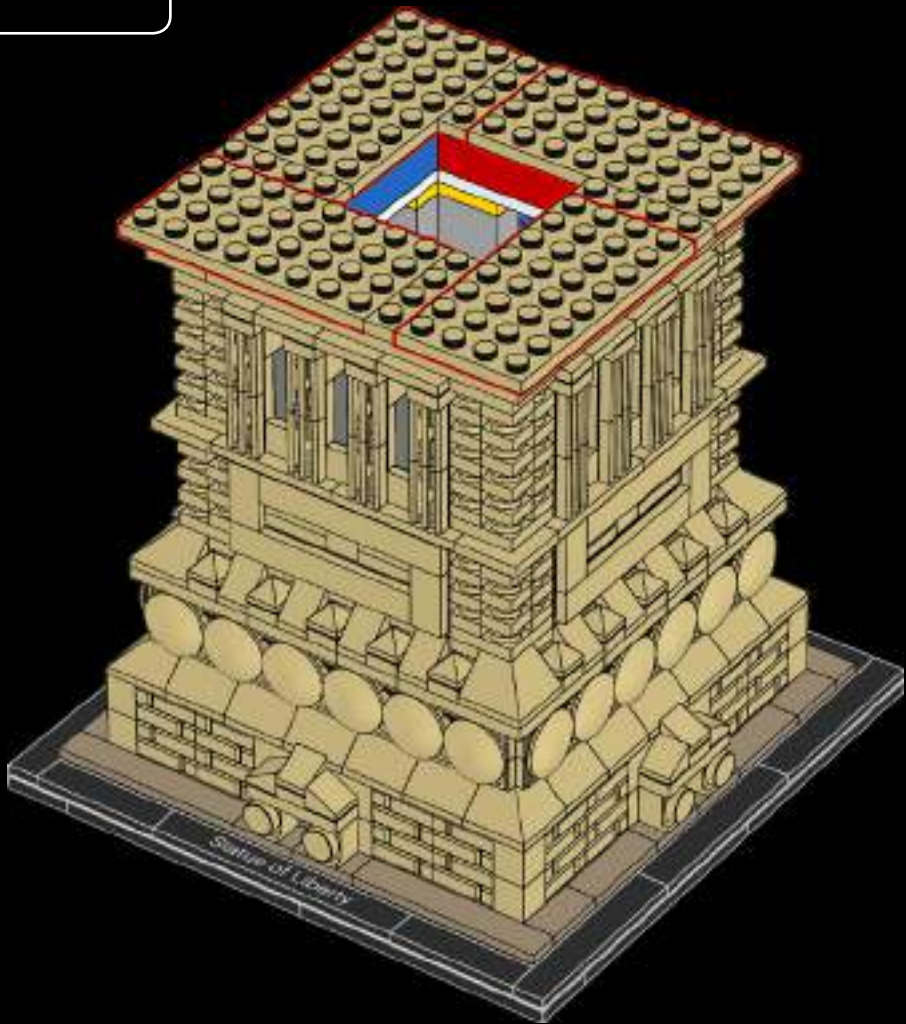



43





16x



16x

44

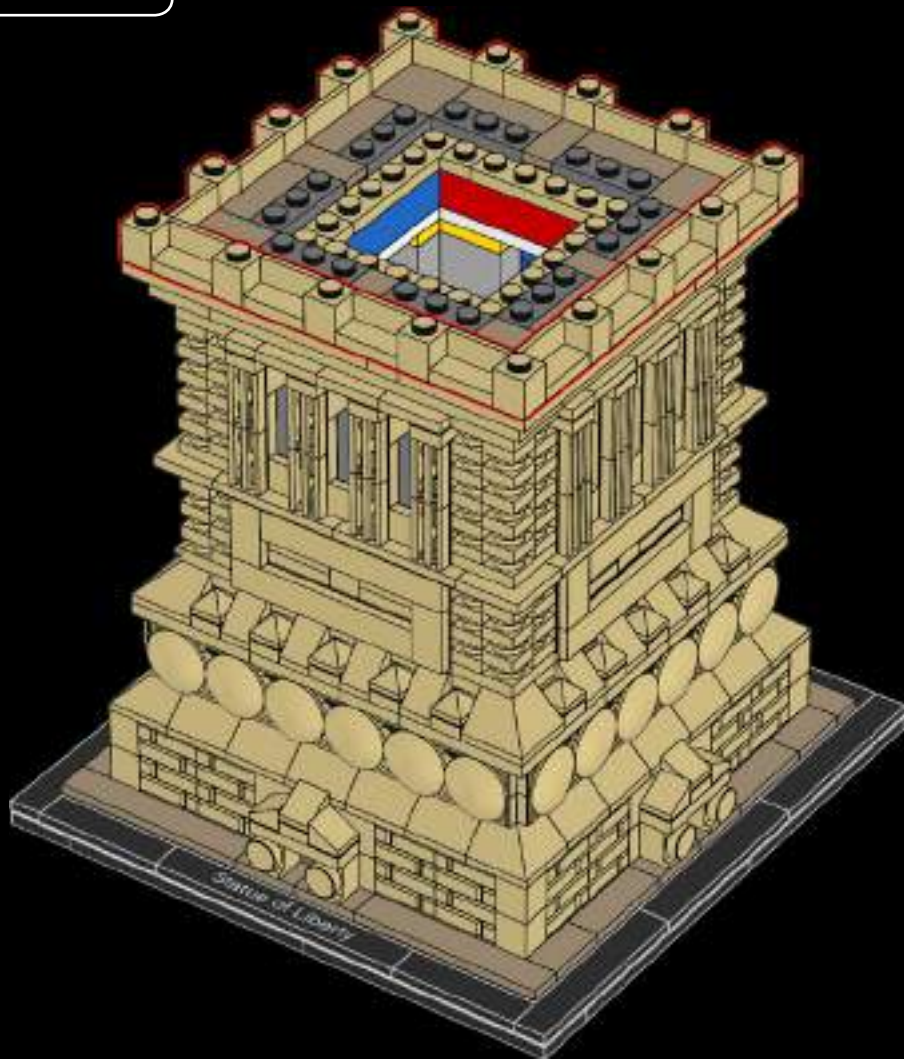

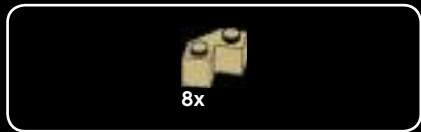

45





16x

46



8x

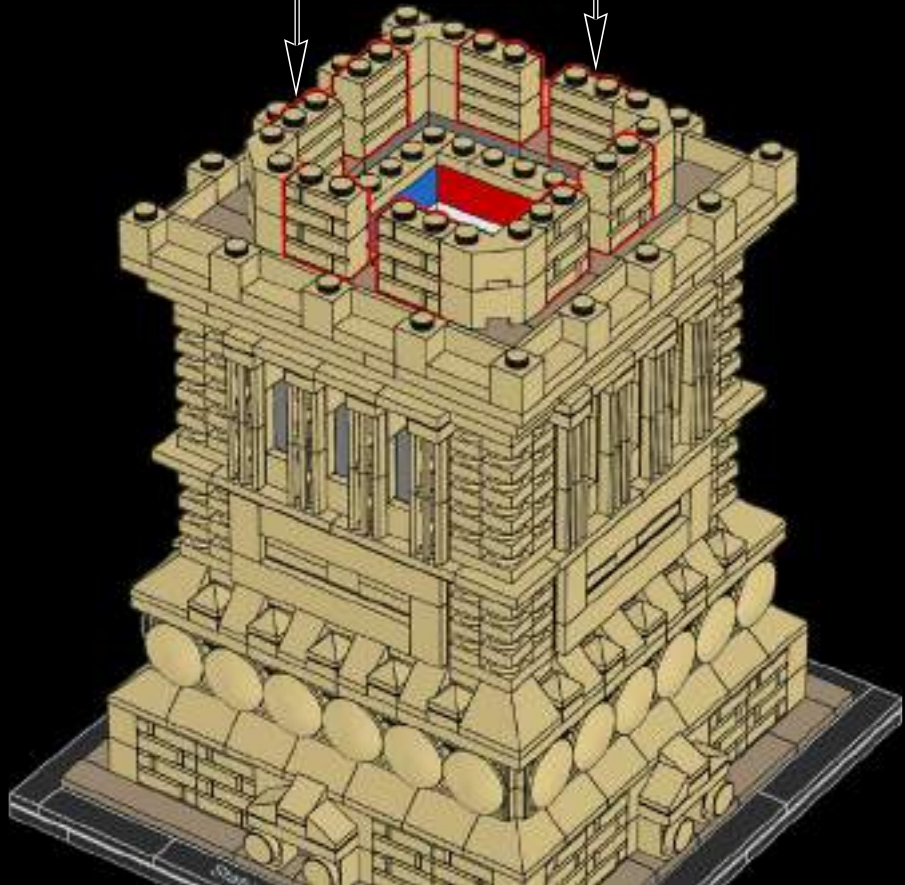

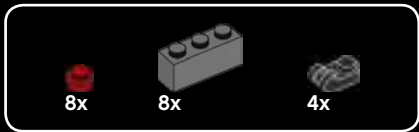

47

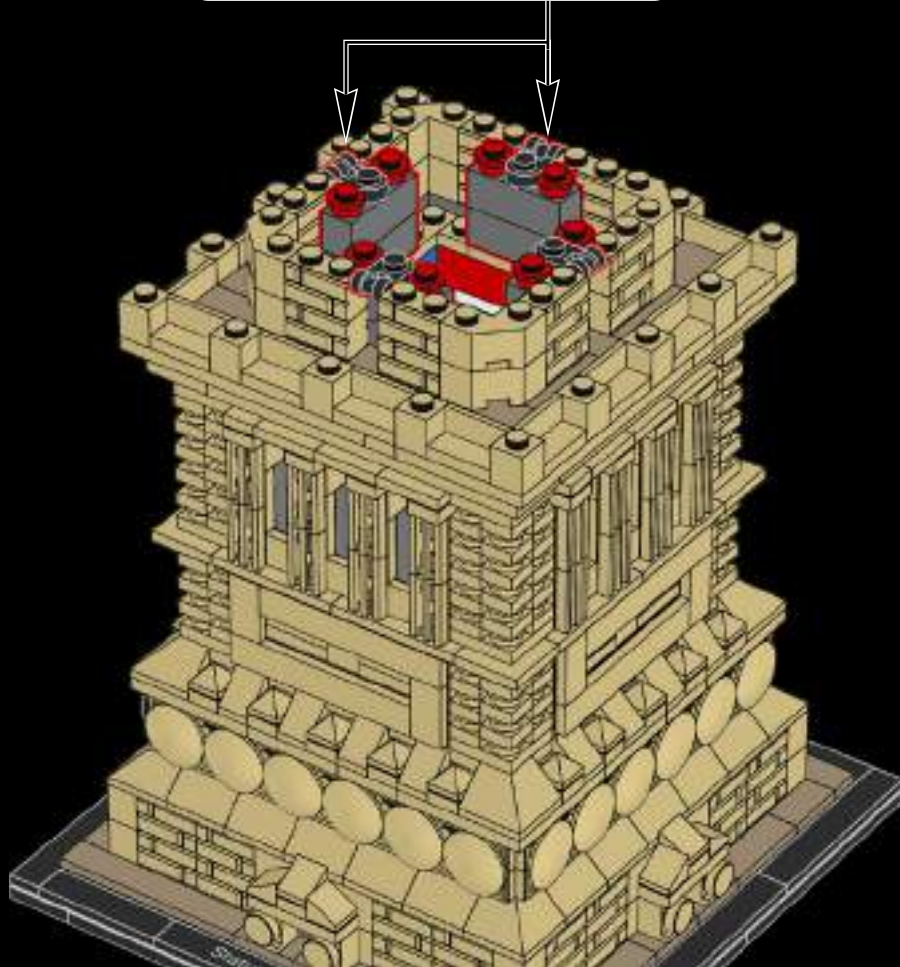
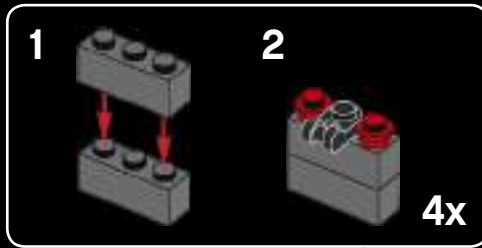

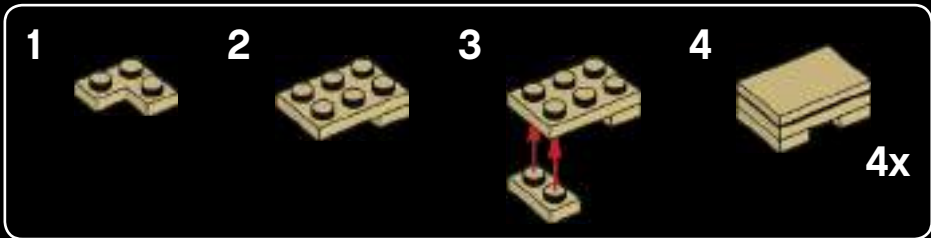
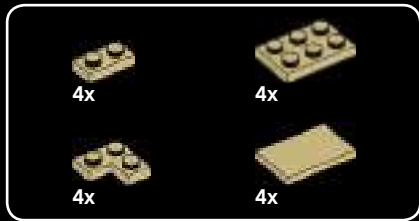

48

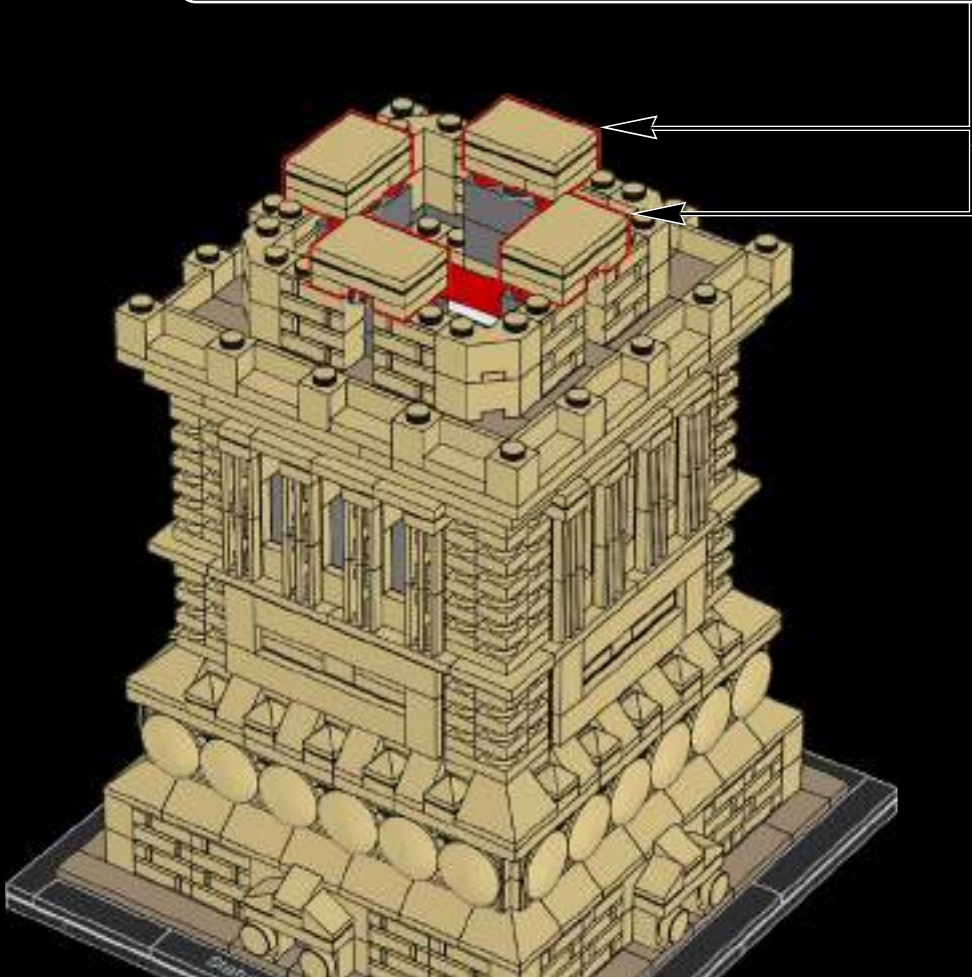

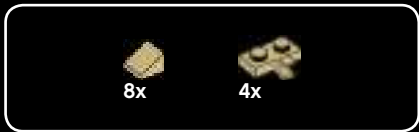

49

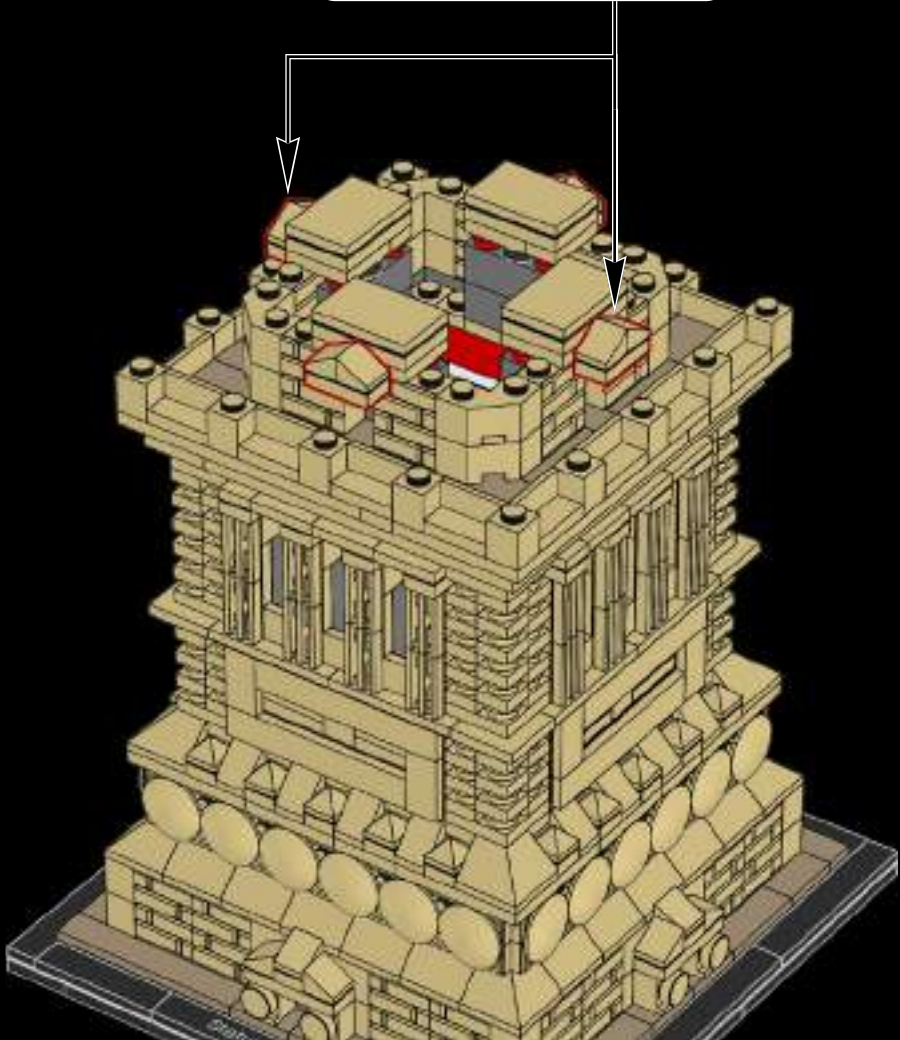



8x



4x

50

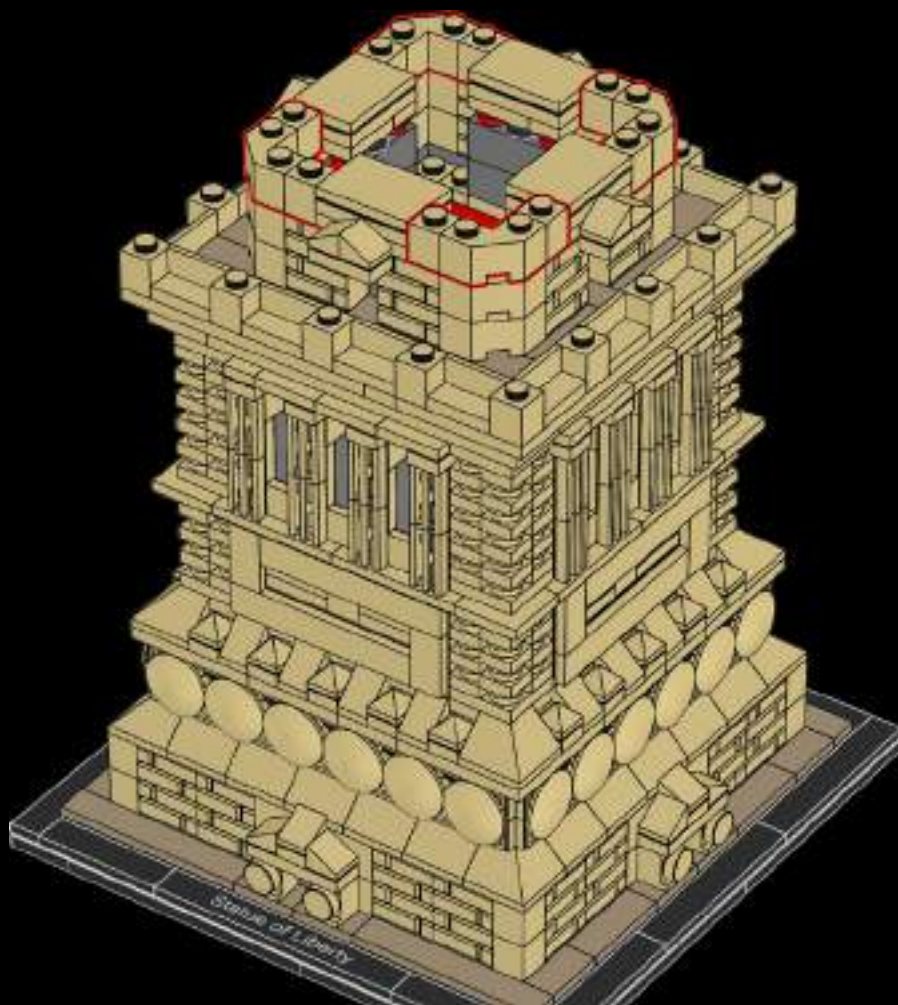



51

1



2



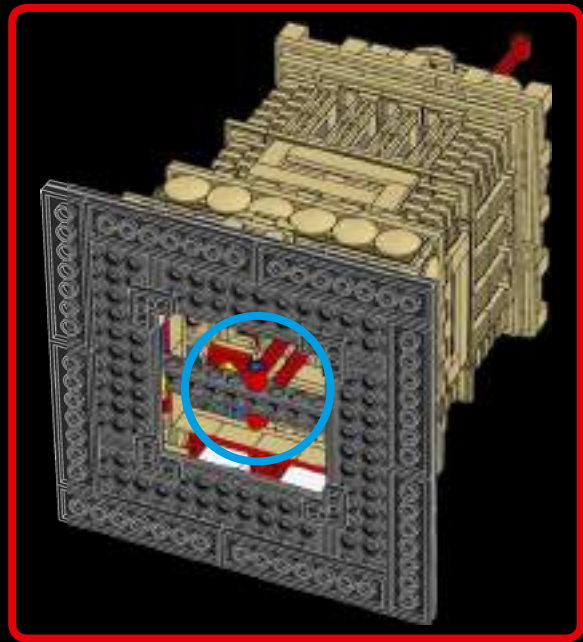
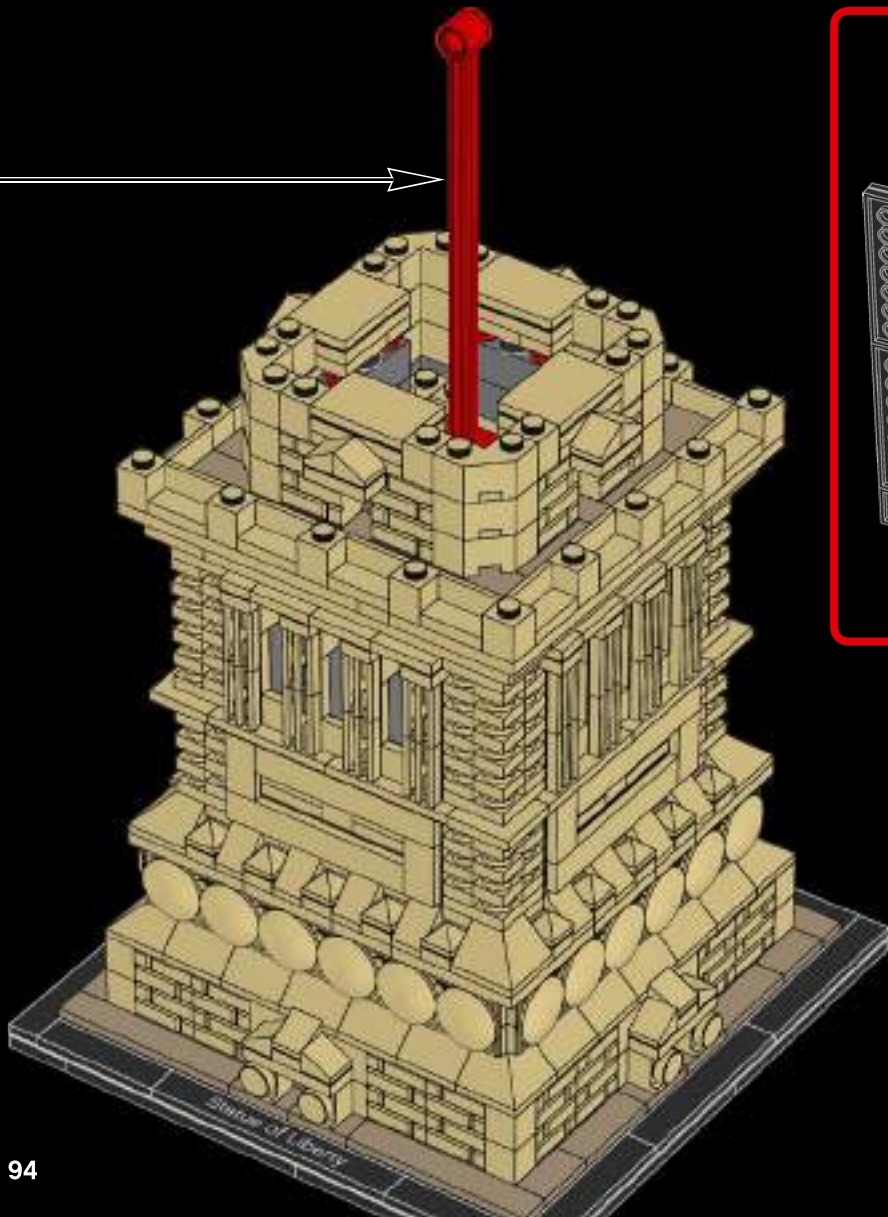

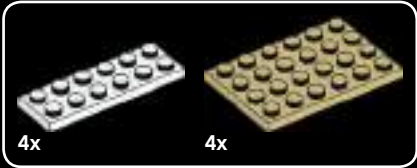

52

1



2



3

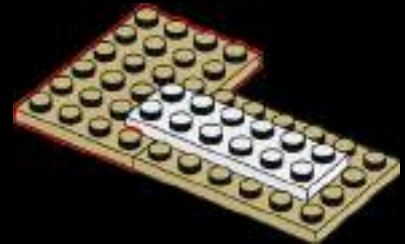

4

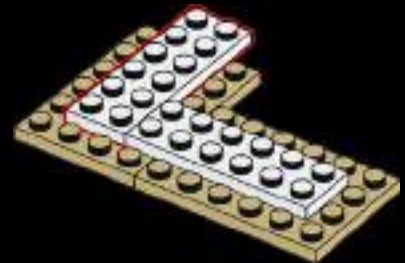

5

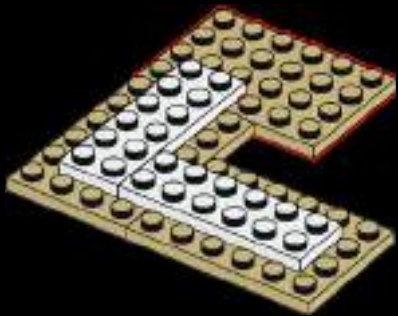

6

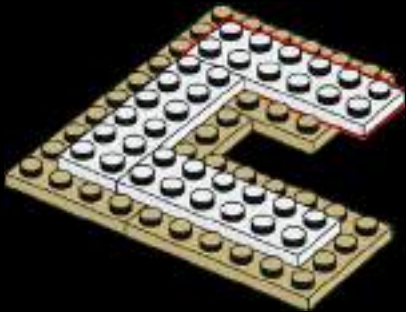

7



8

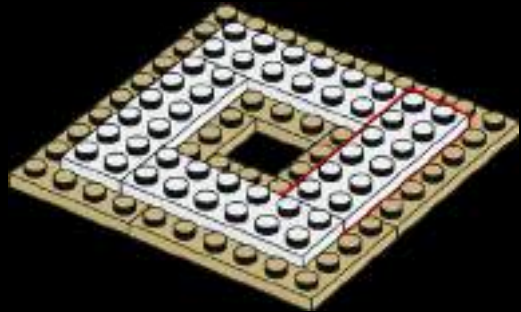

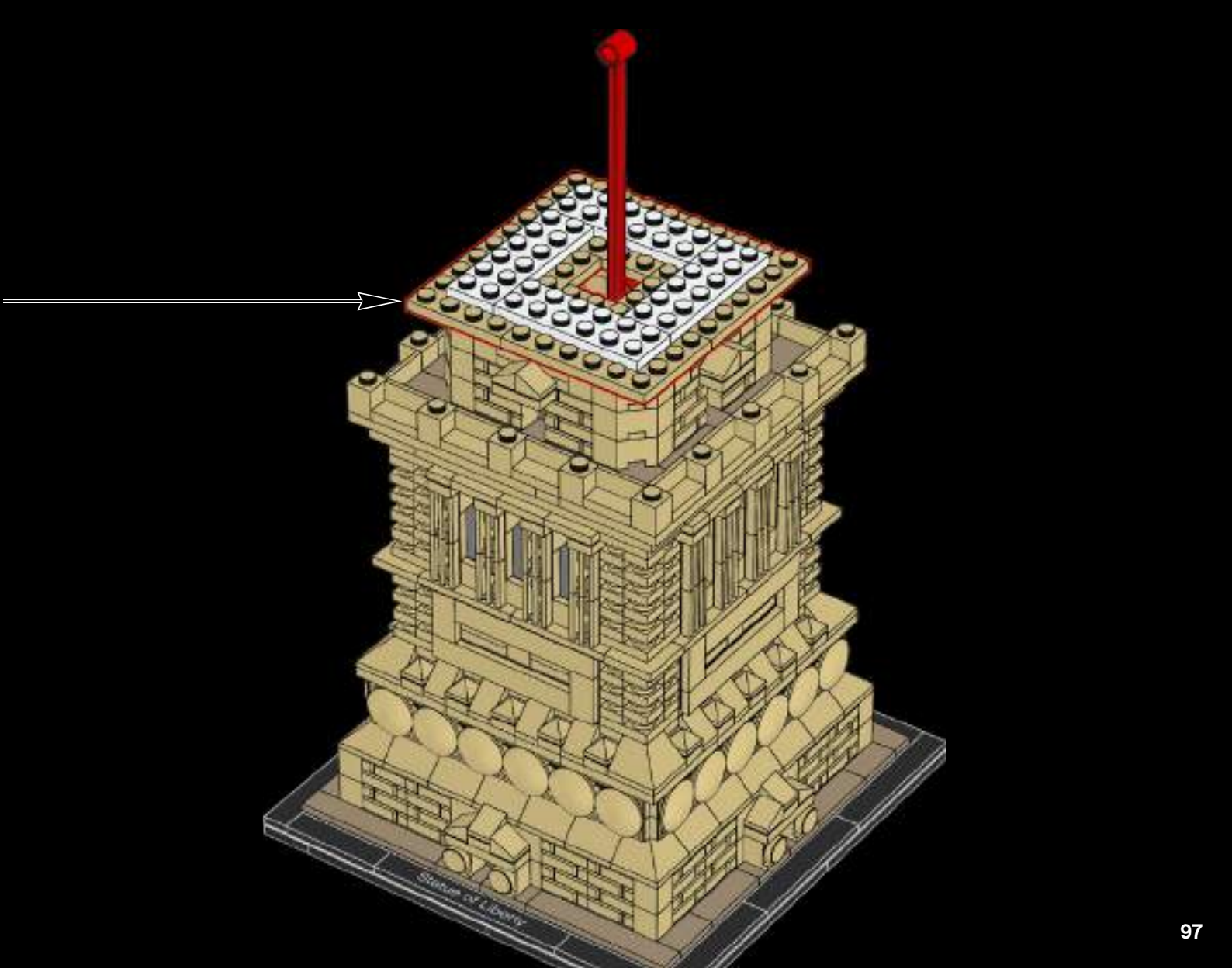

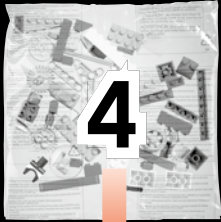

53

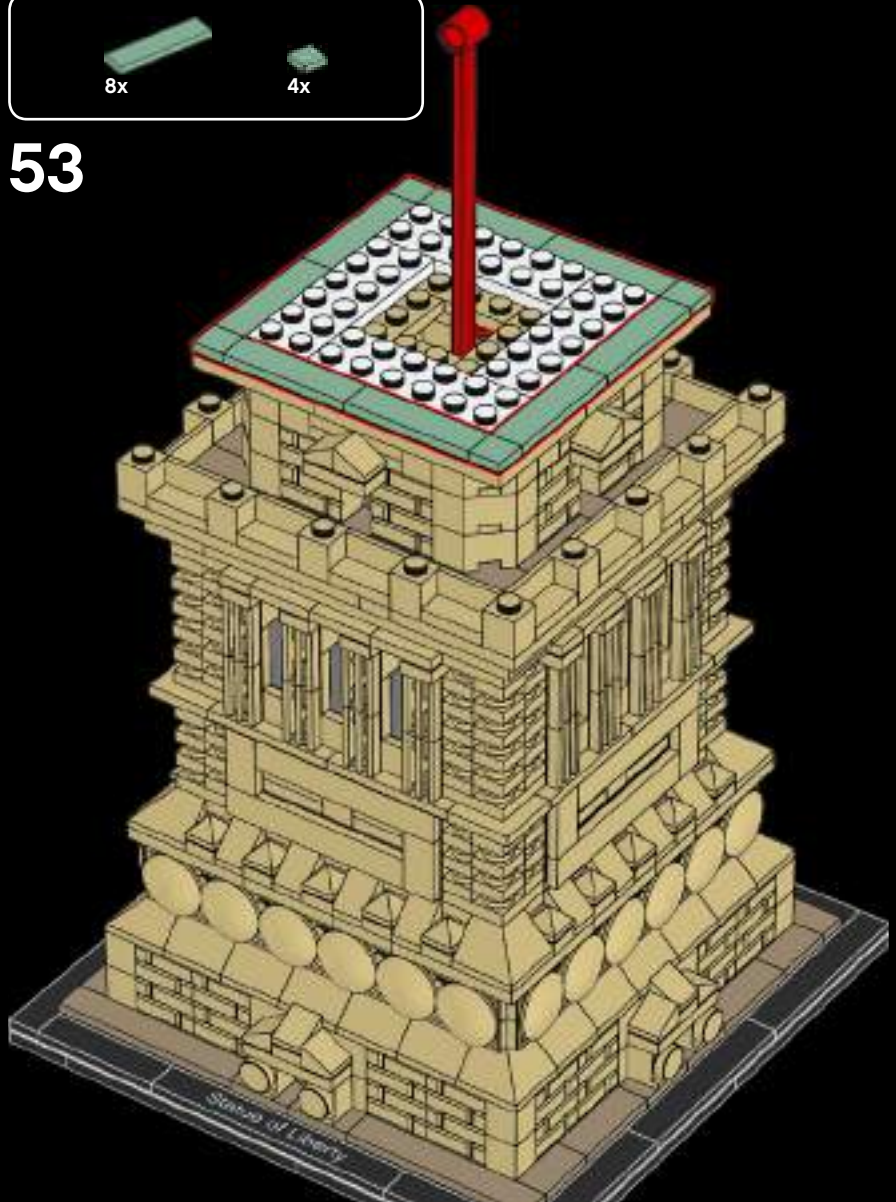



54

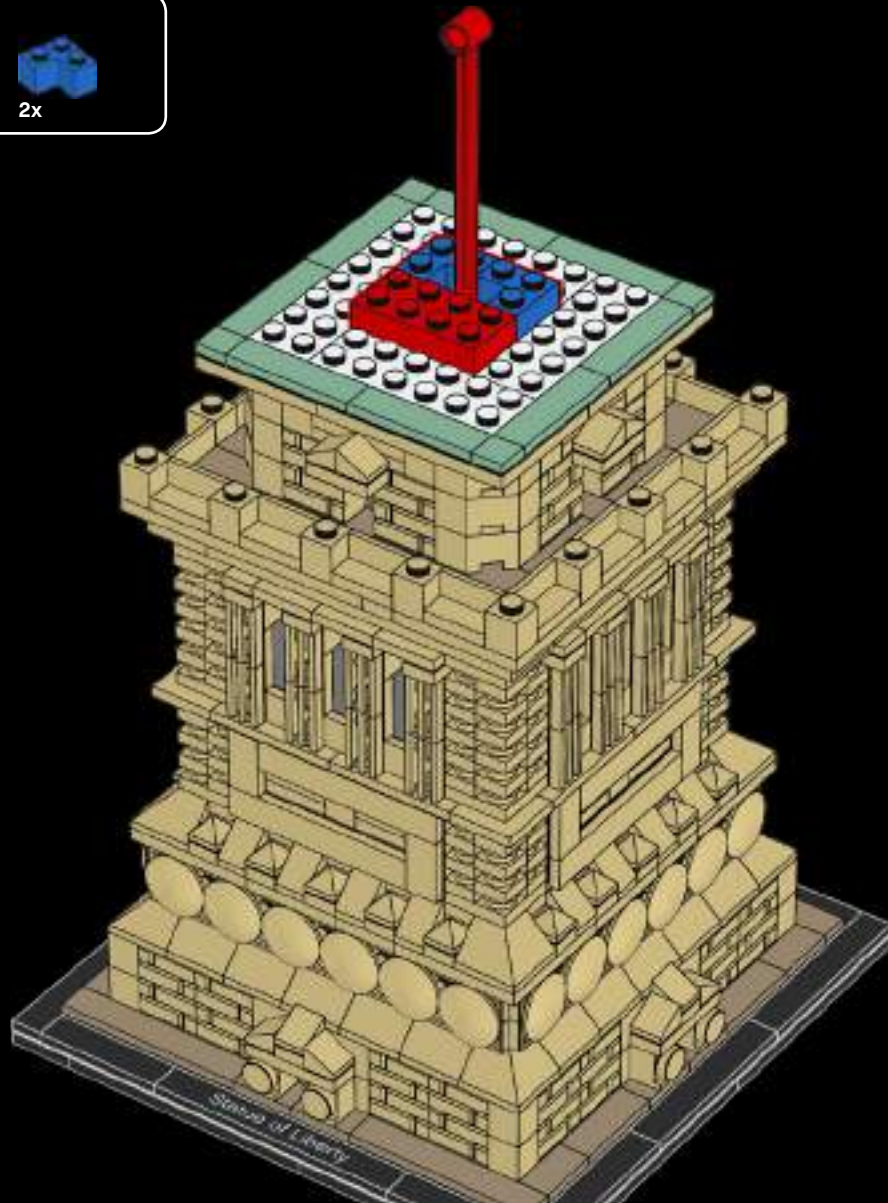



55

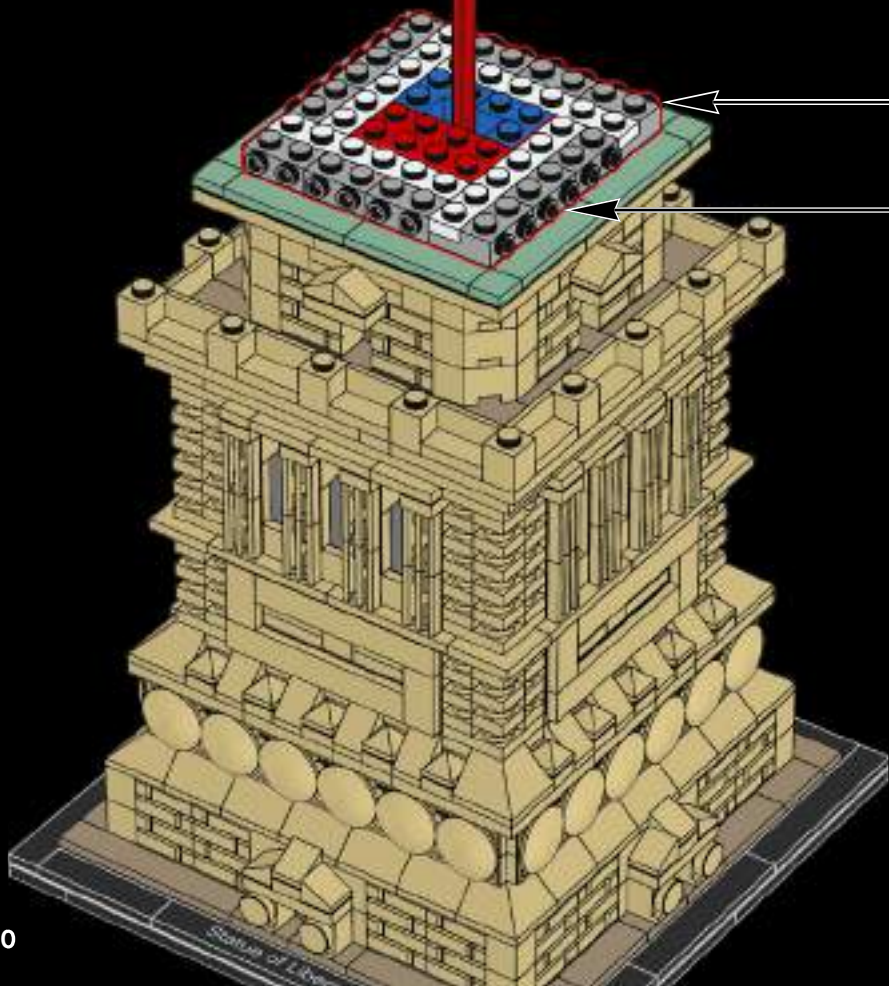
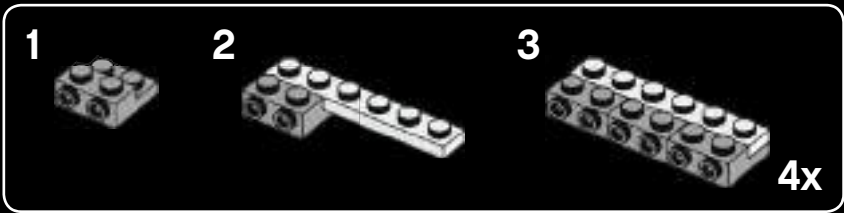



56

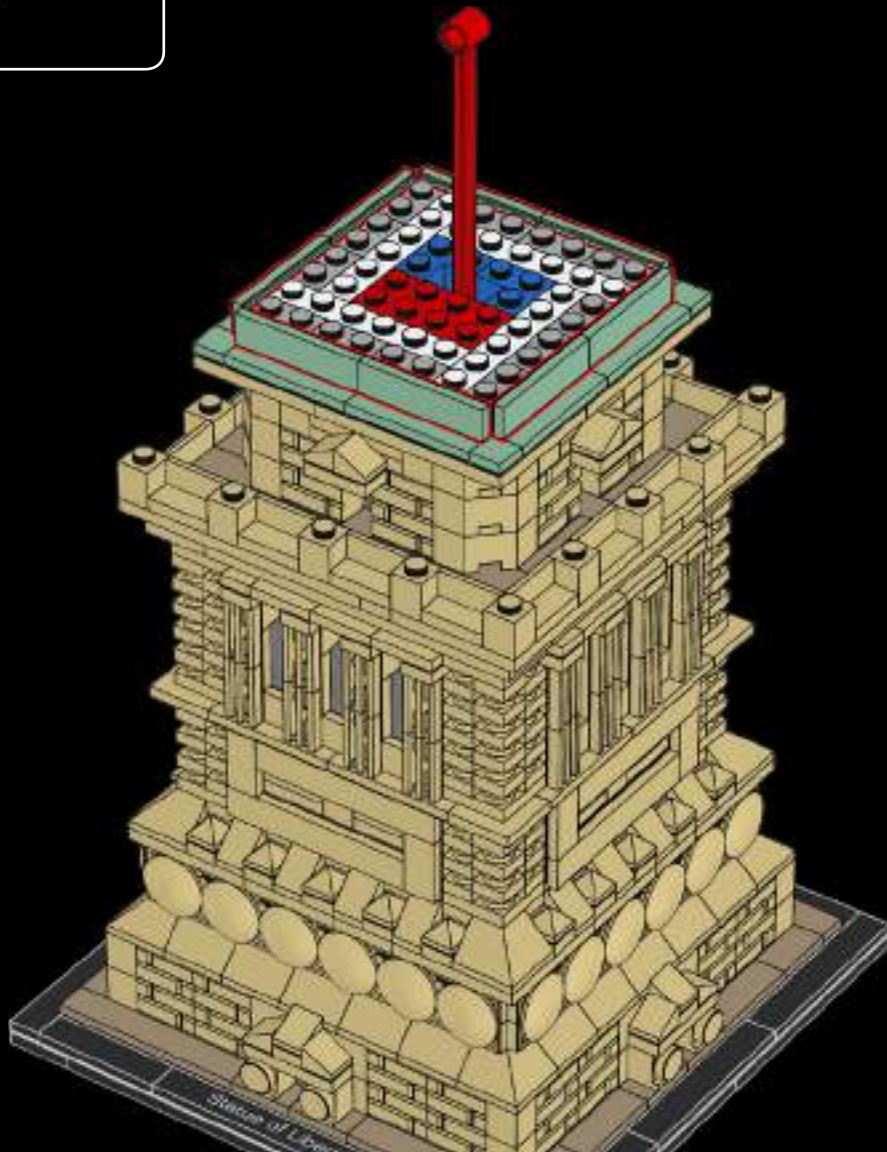



57

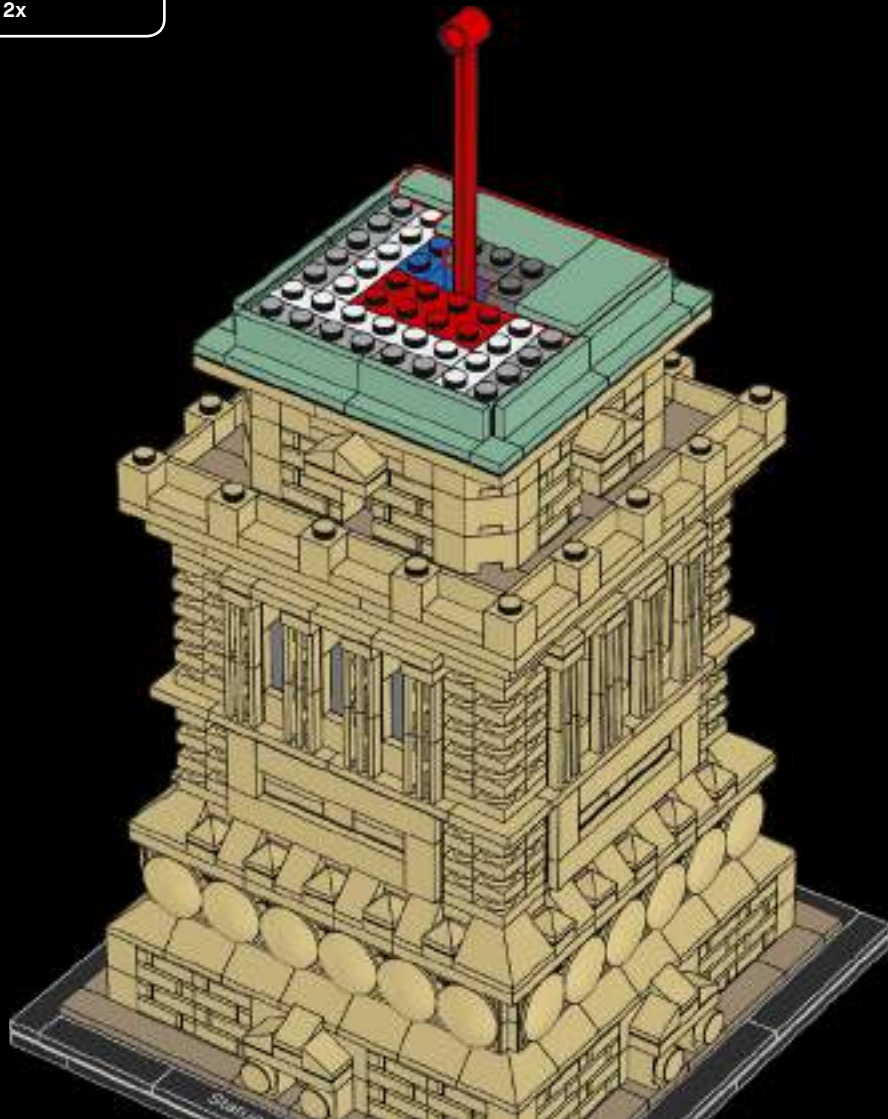



58

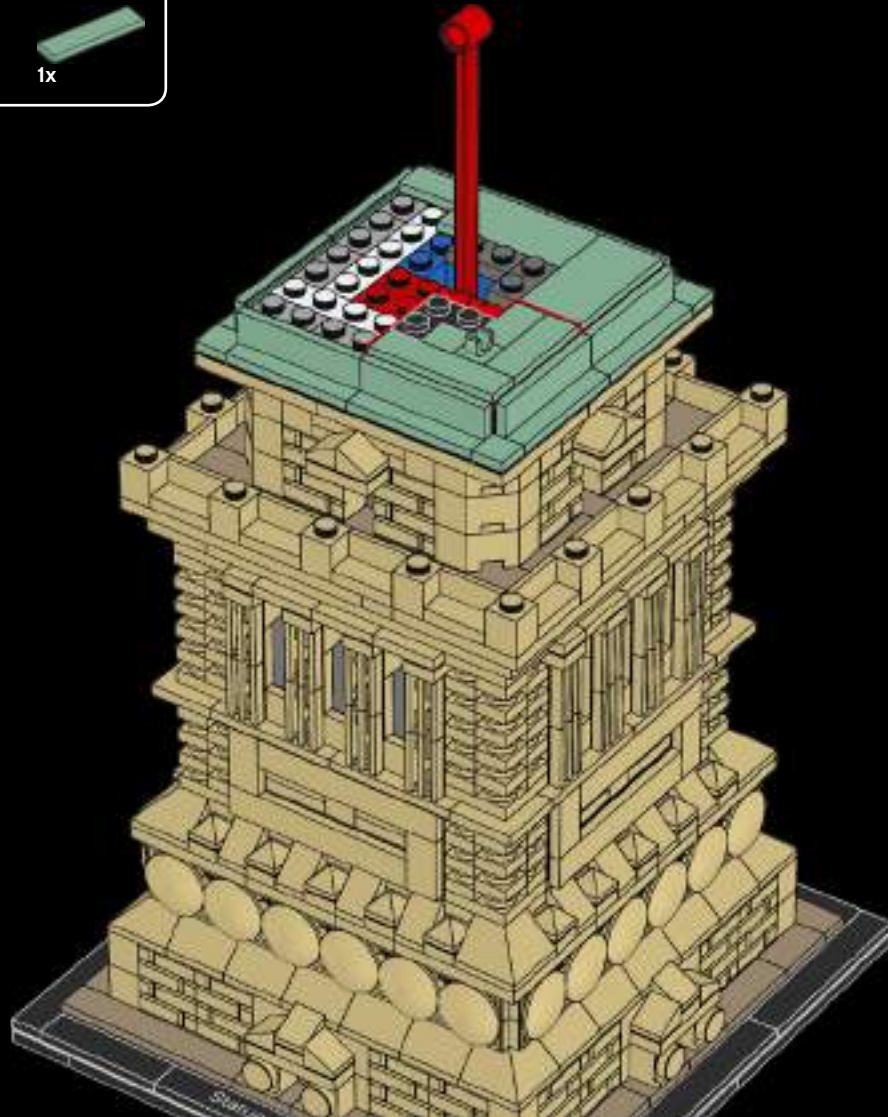

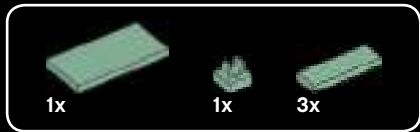

59

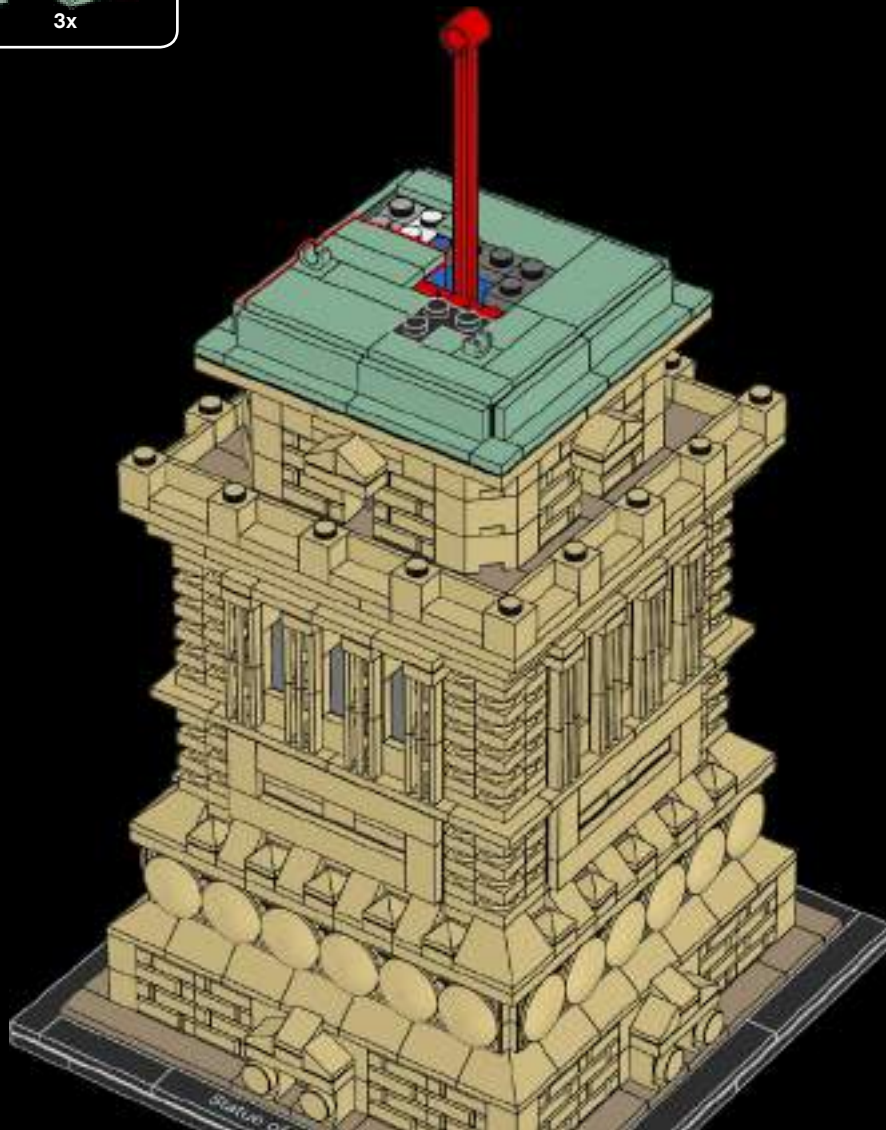

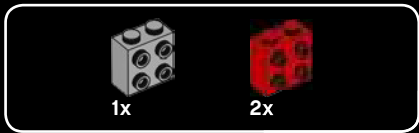

60

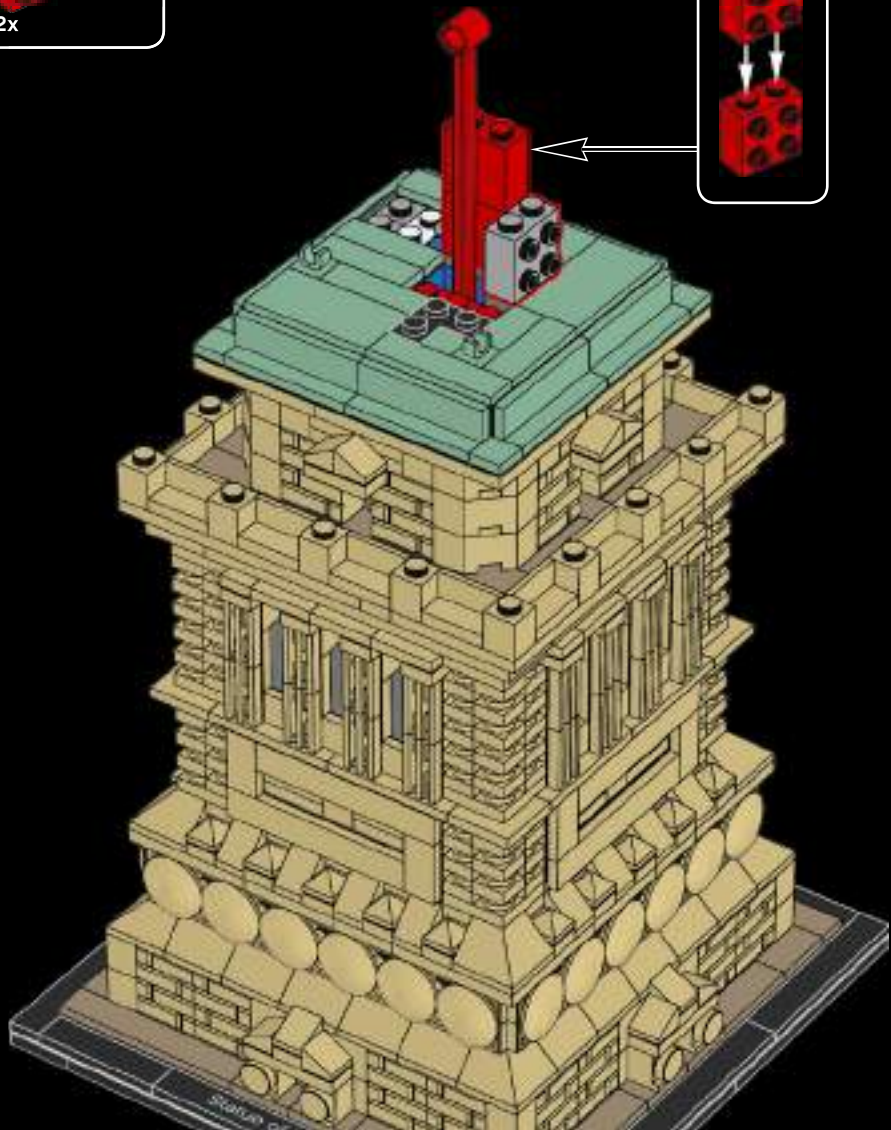
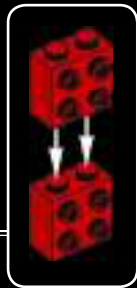

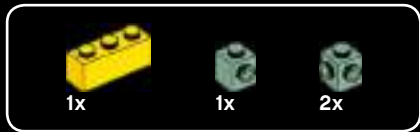

61



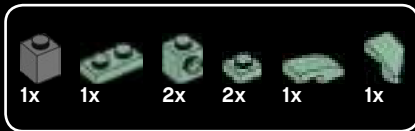

62

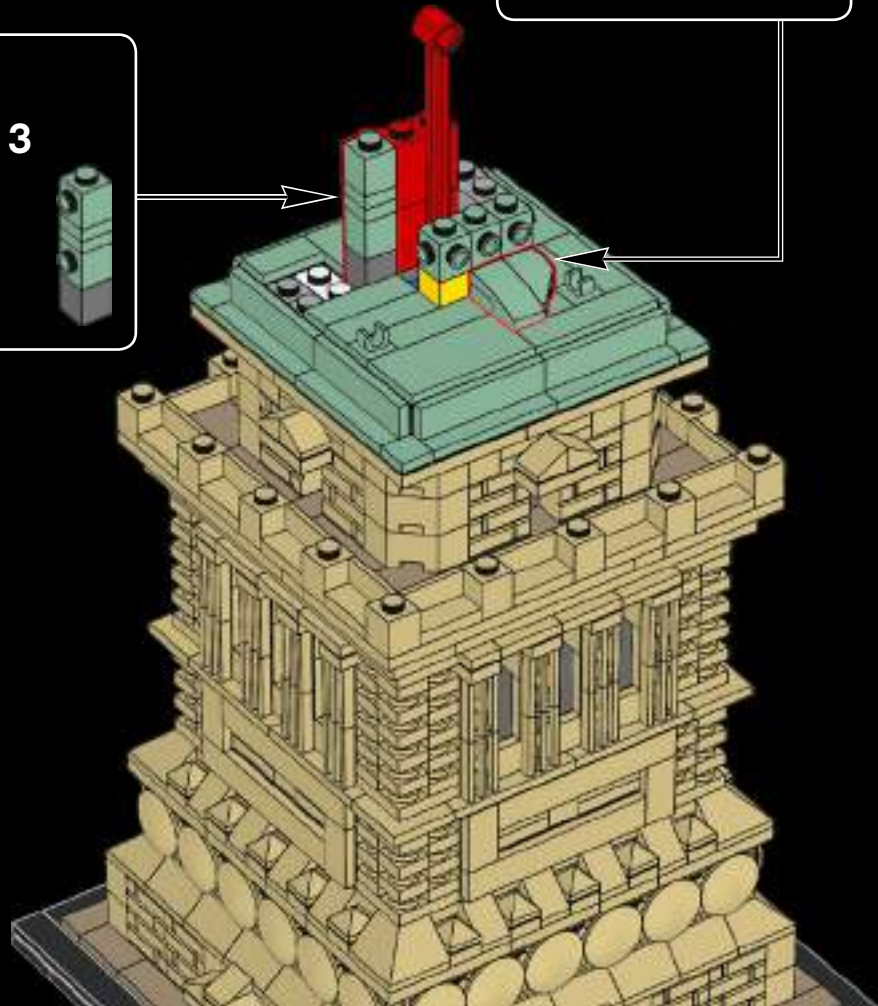
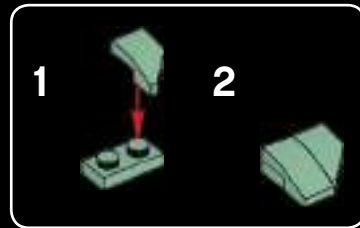
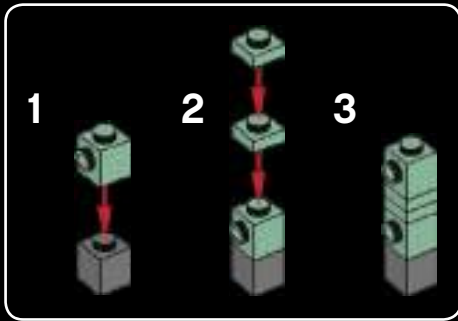



63

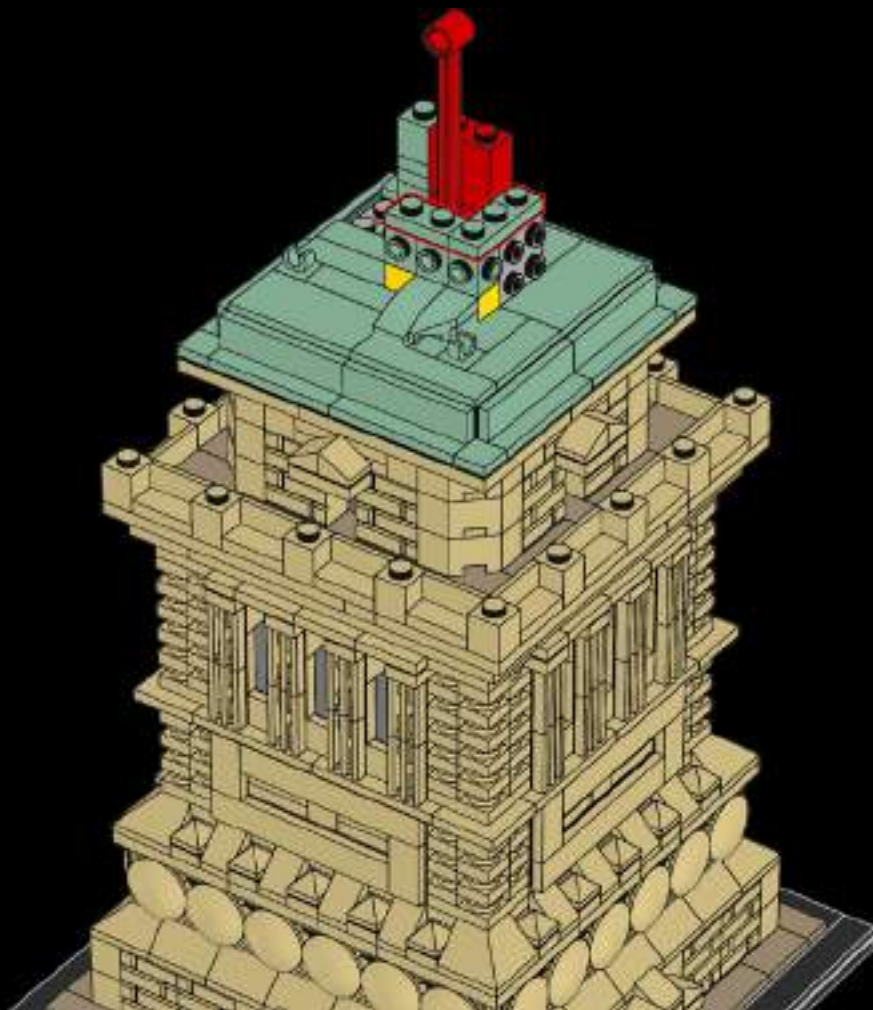



64

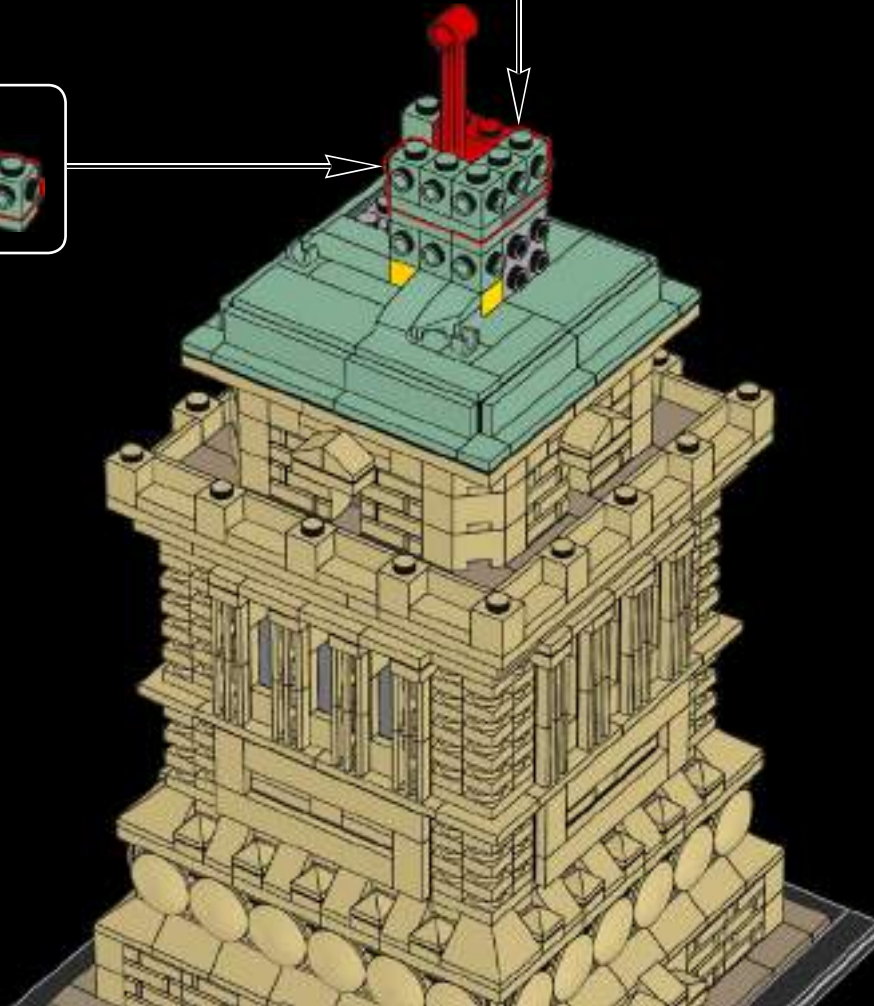
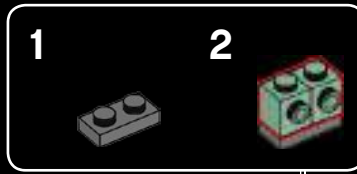



2x



1x

65

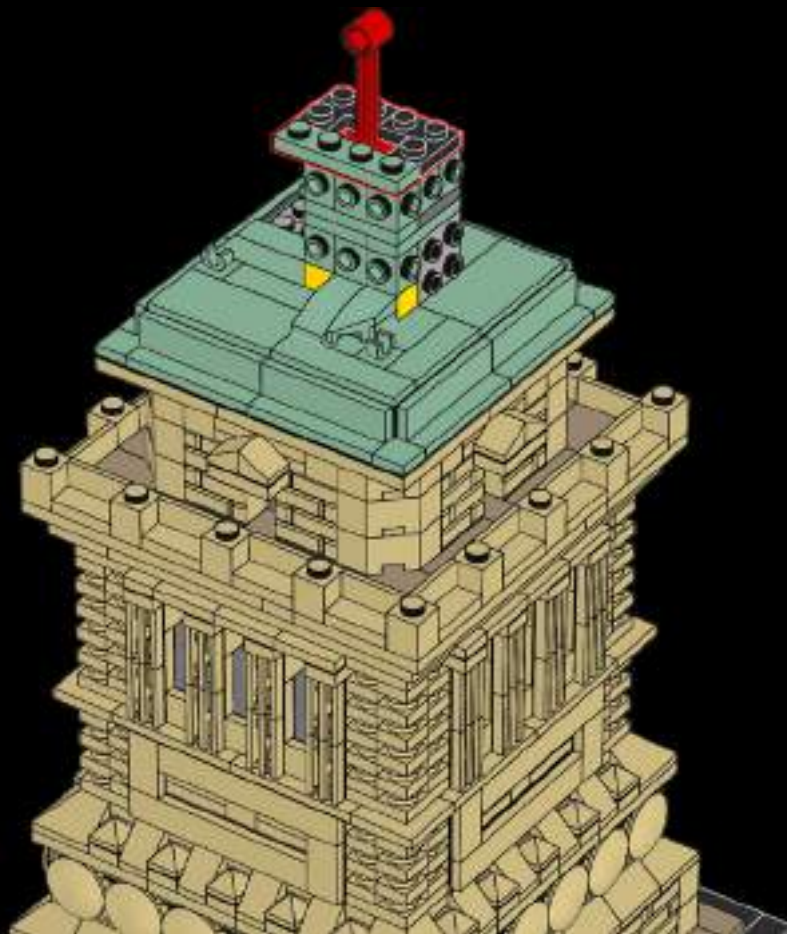



66

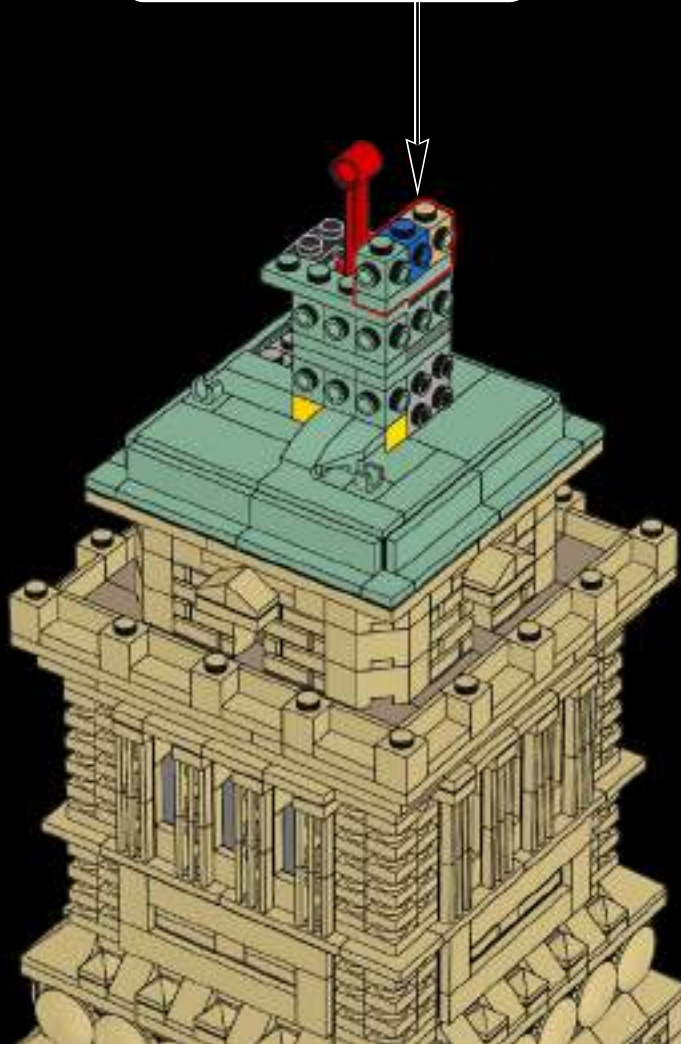



67

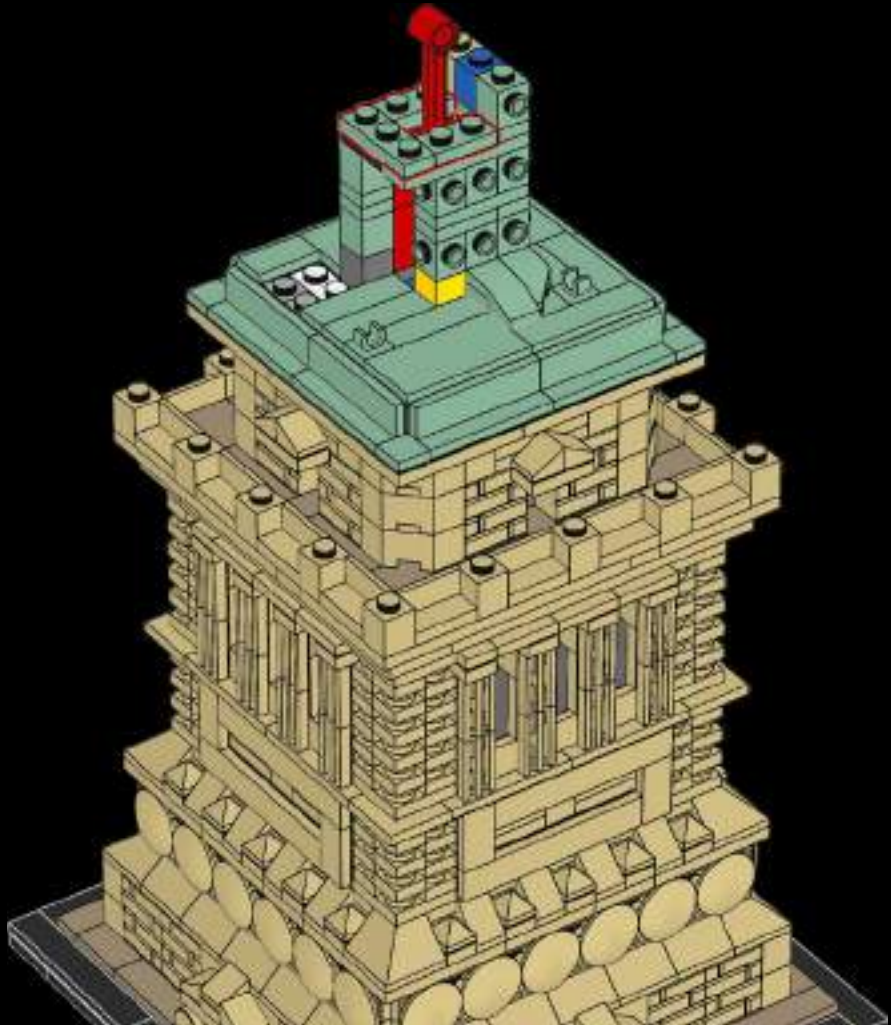



1x



1x



1x



2x

68

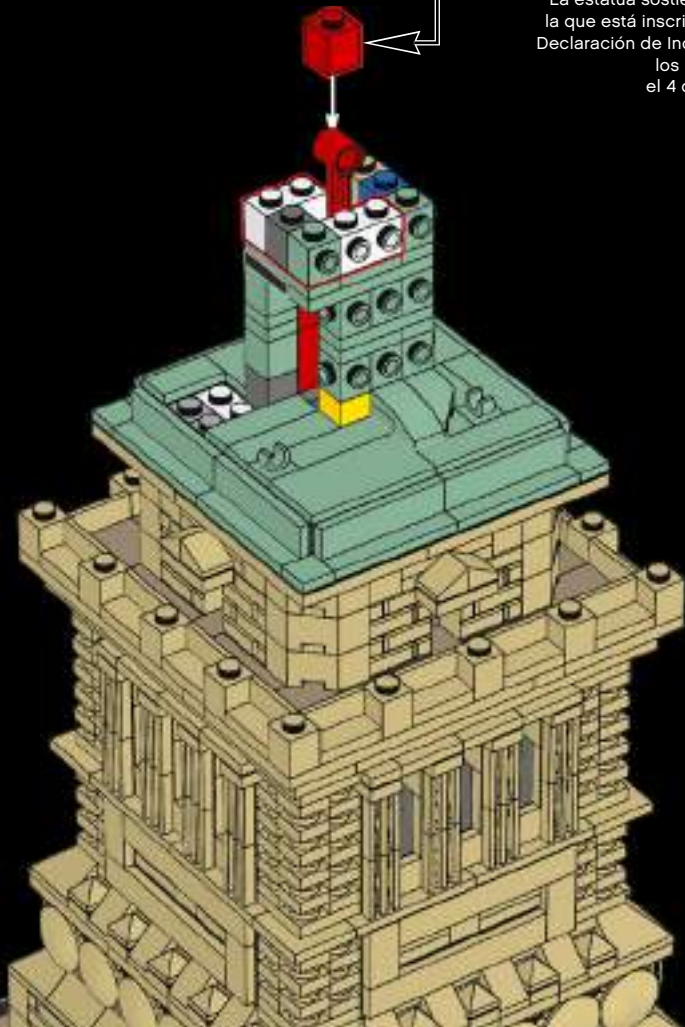

The Statue holds a tablet upon which is inscribed the date of the American Declaration of Independence (July 4, 1776).
 La statue tient une tablette sur laquelle est inscrite la date de la Déclaration d'indépendance des États-Unis (le 4 juillet 1776).
 La estatua sostiene una tabla en la que está inscrita la fecha de la Declaración de Independencia de los Estados Unidos: el 4 de julio de 1776.





2x



2x

69

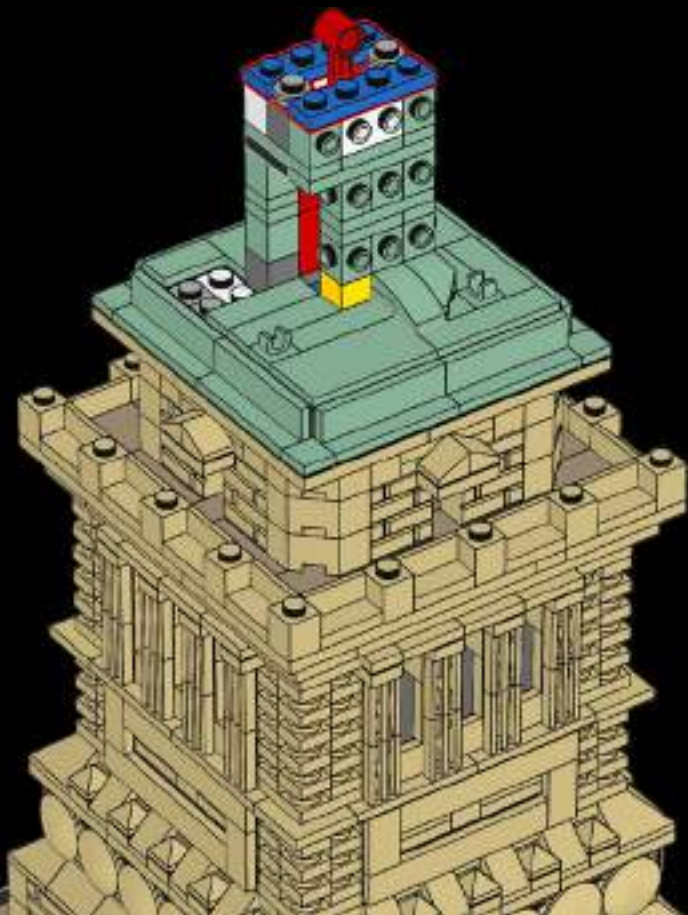



2x



1x

70

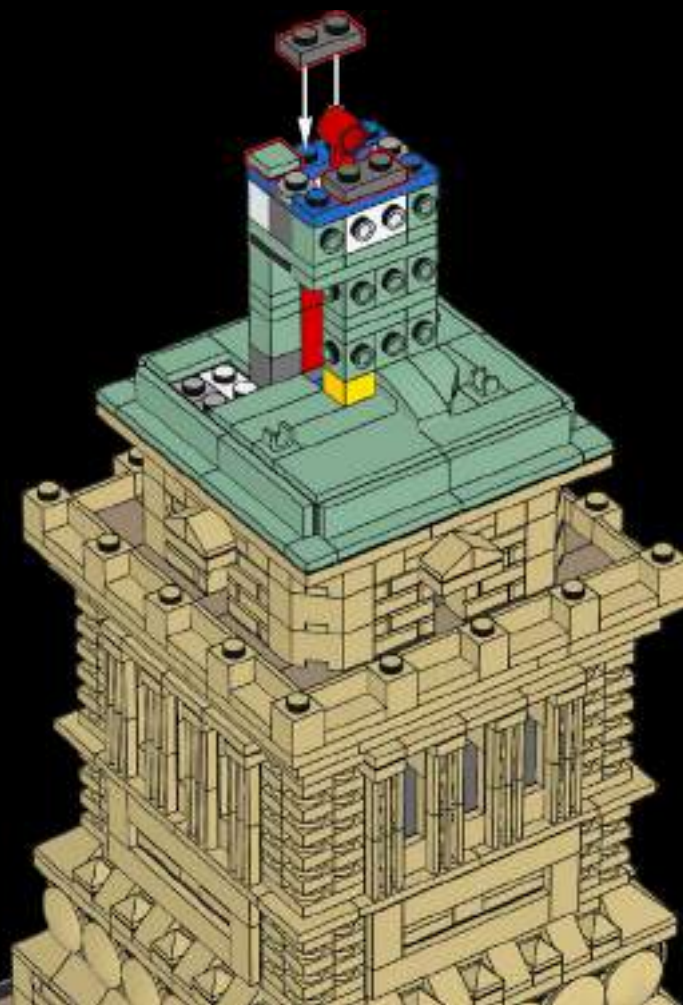

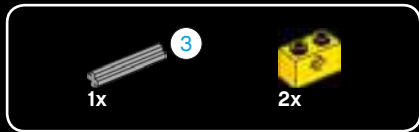

71

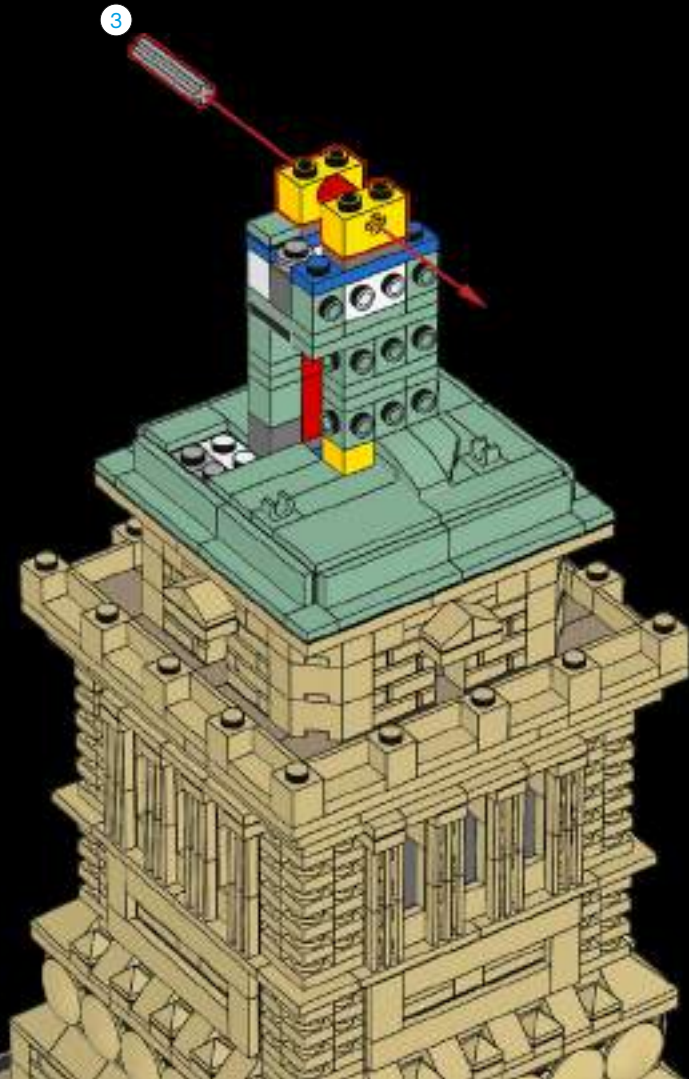

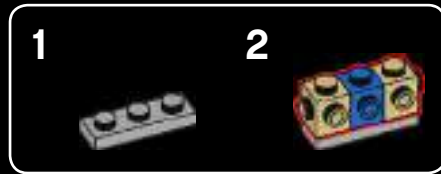
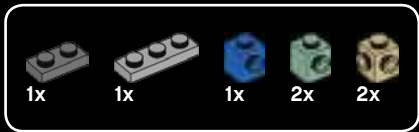

72

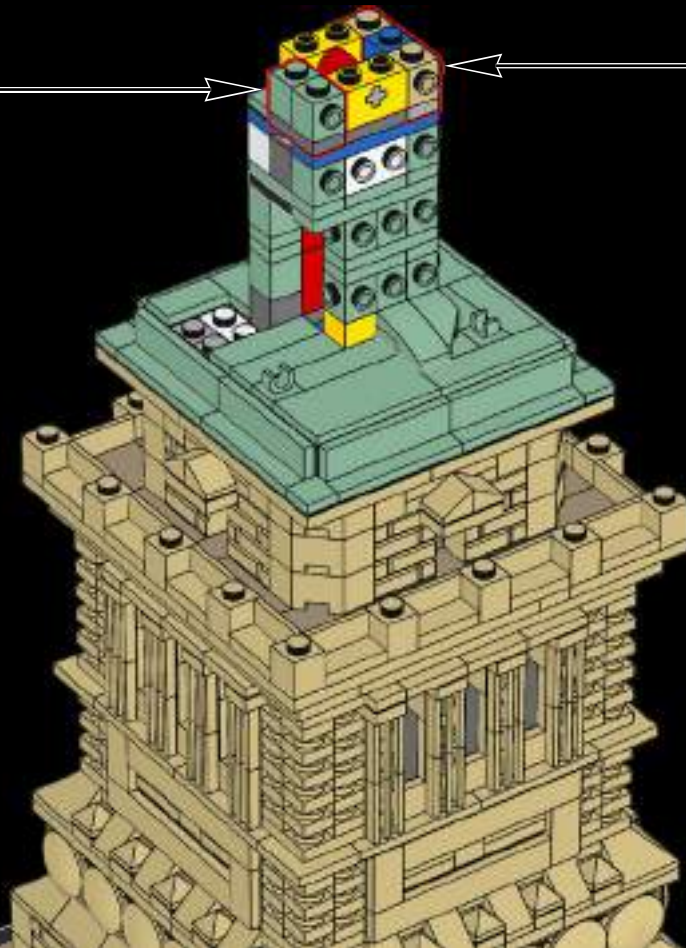
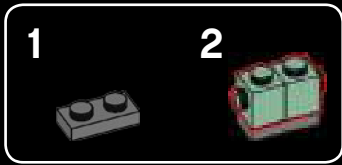



5x



5x



5x



5x



5x



5x



5x



20x



5x



5x

73

1



2



3



4



5



5x

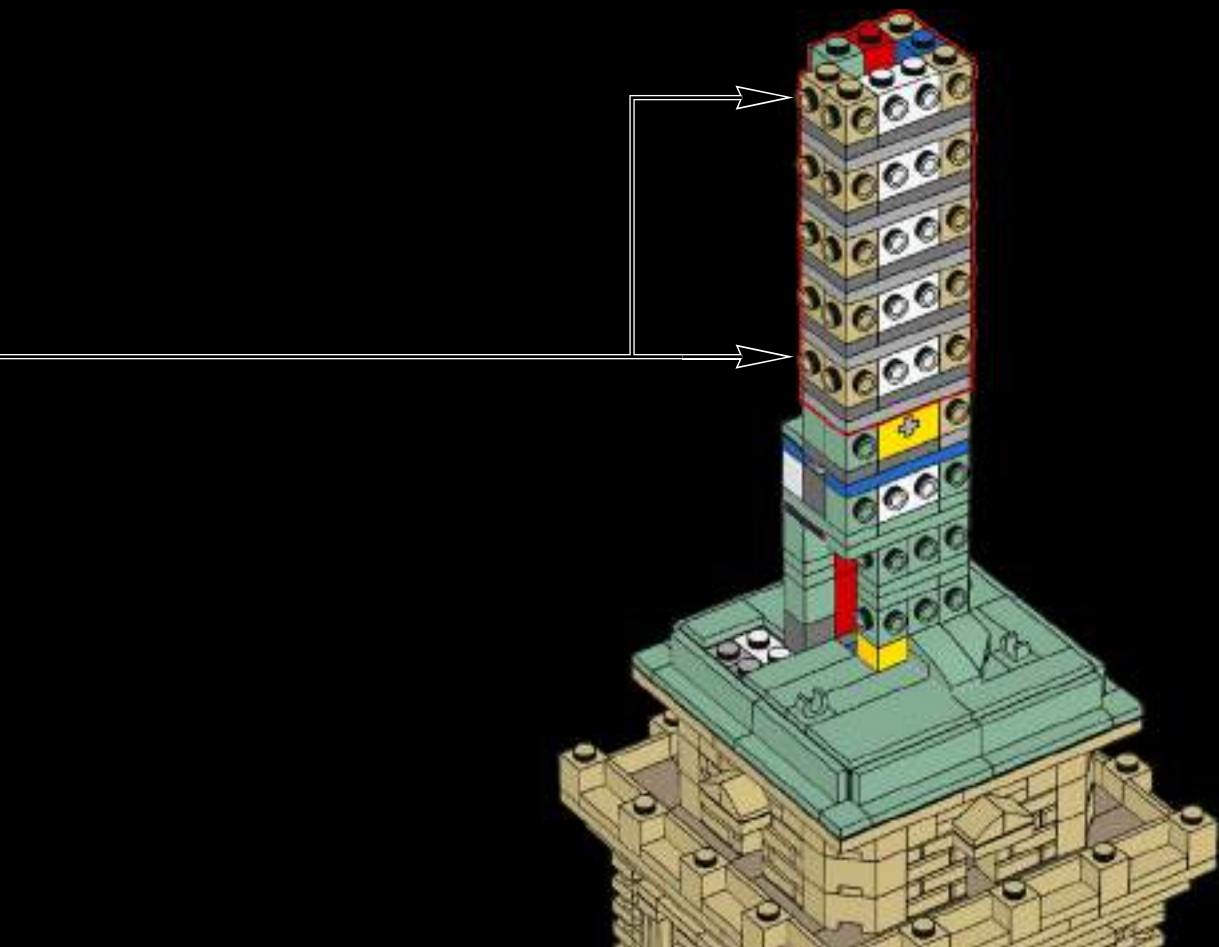



74

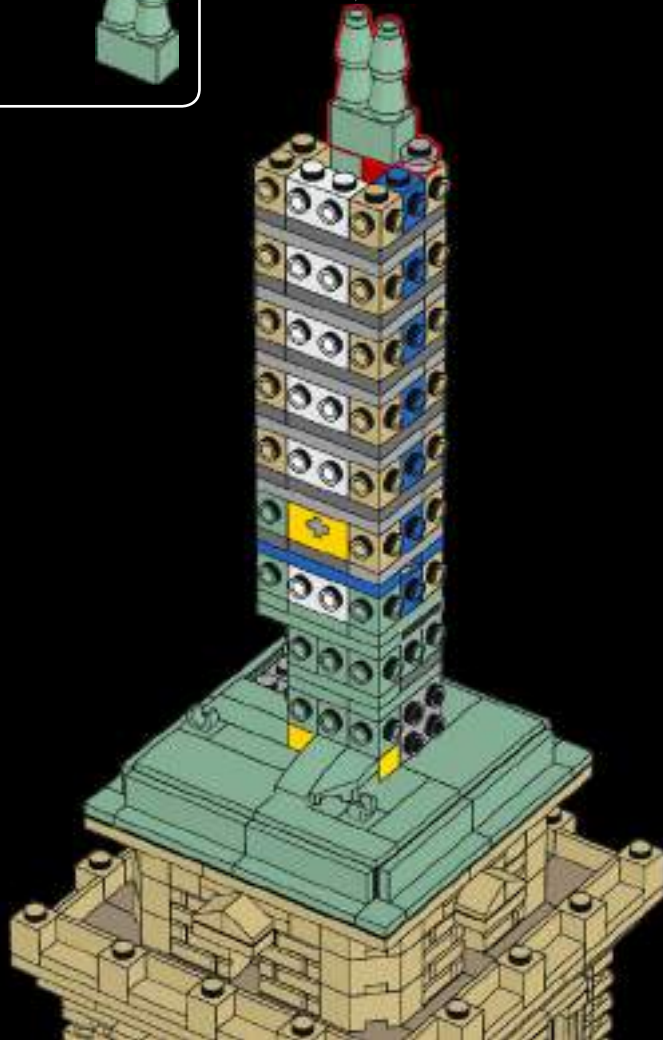
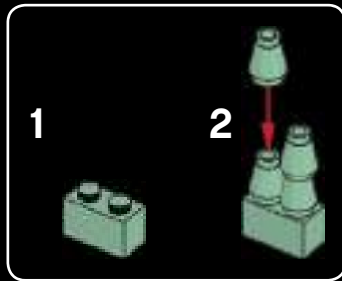

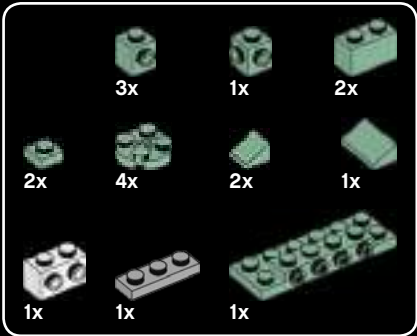

75

1

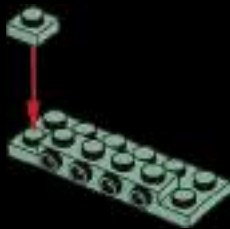

2



3

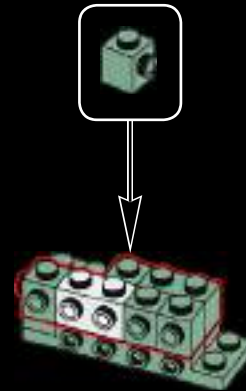

4

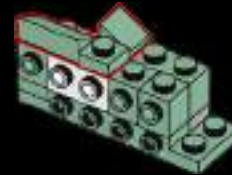

5



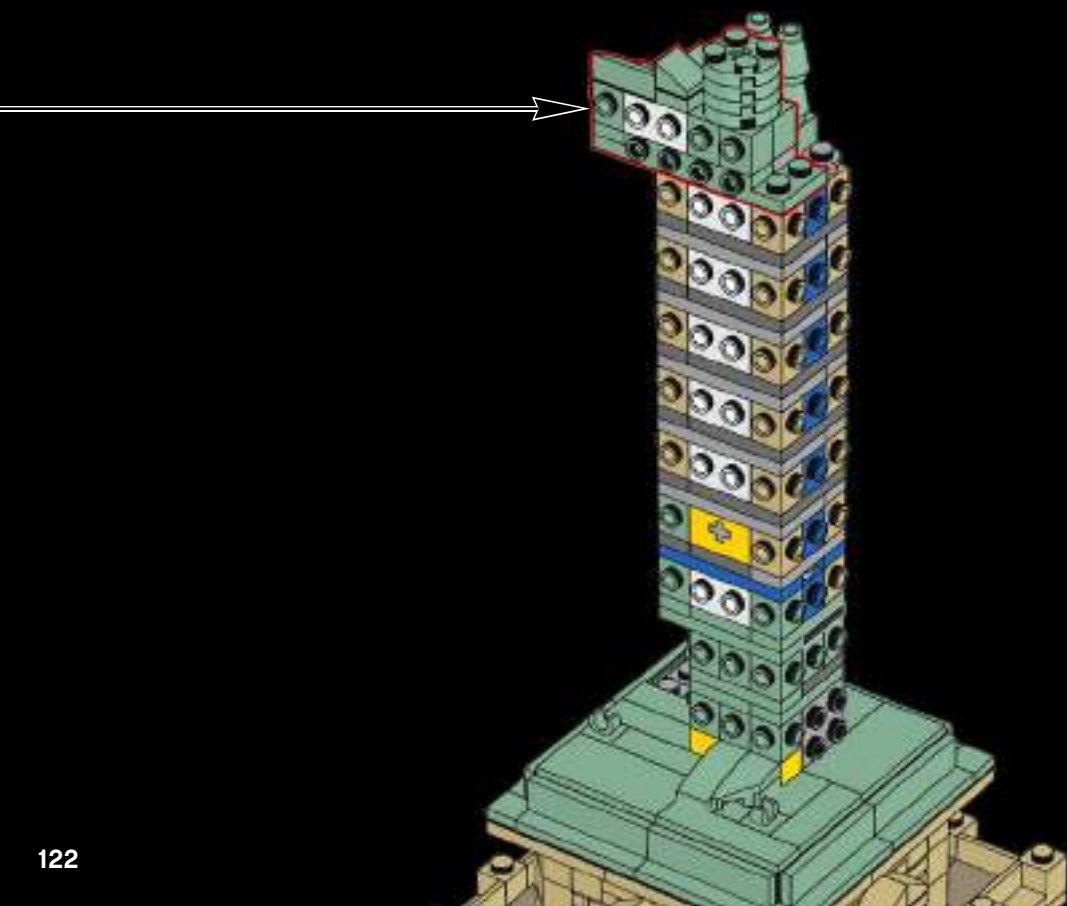



76

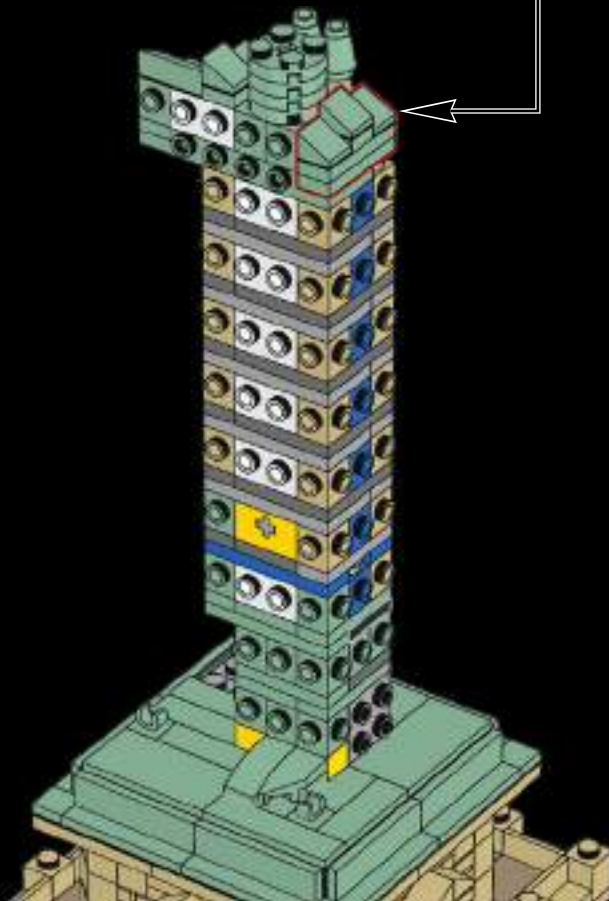

- 1x 
- 2x 
- 1x 

77

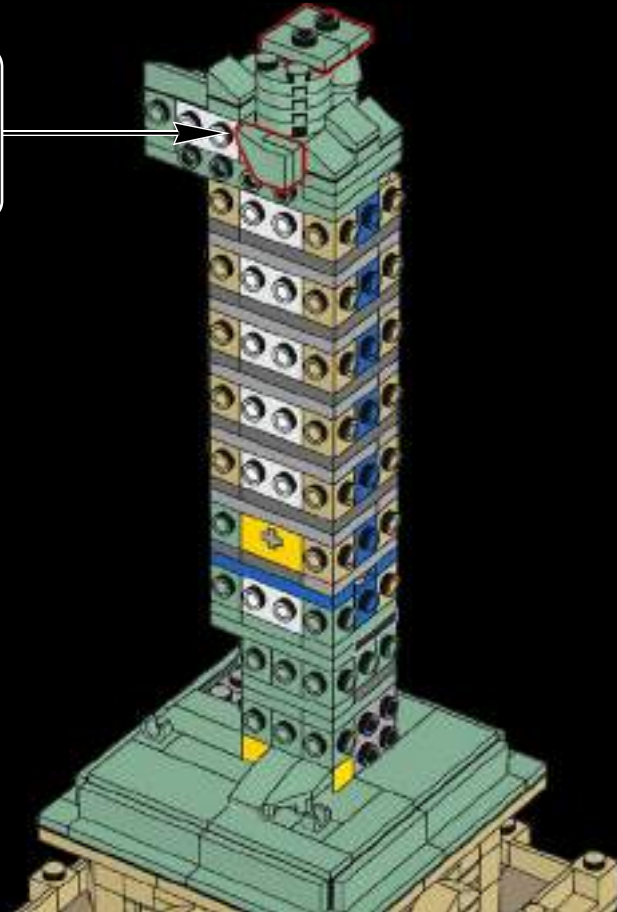



78

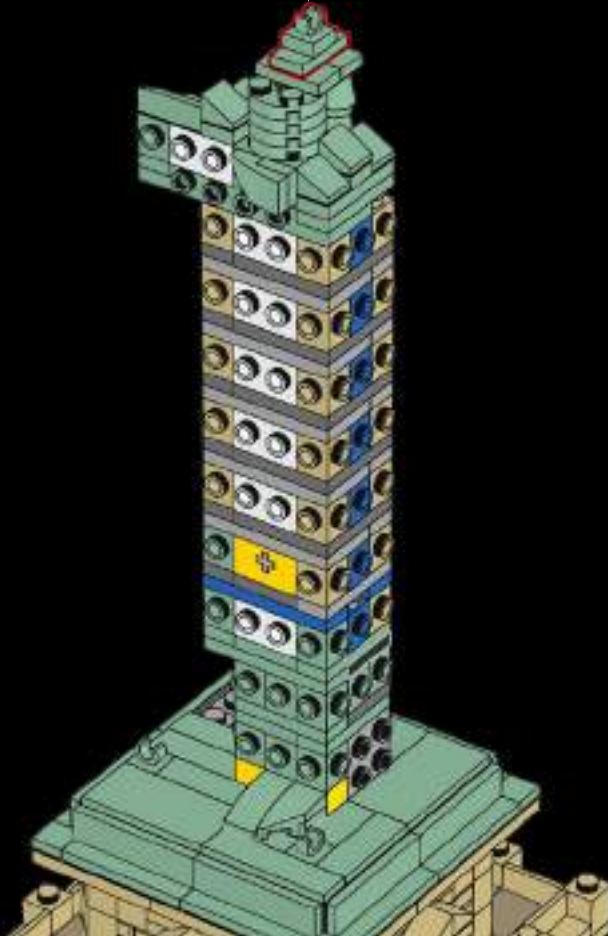
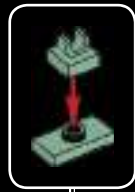



79

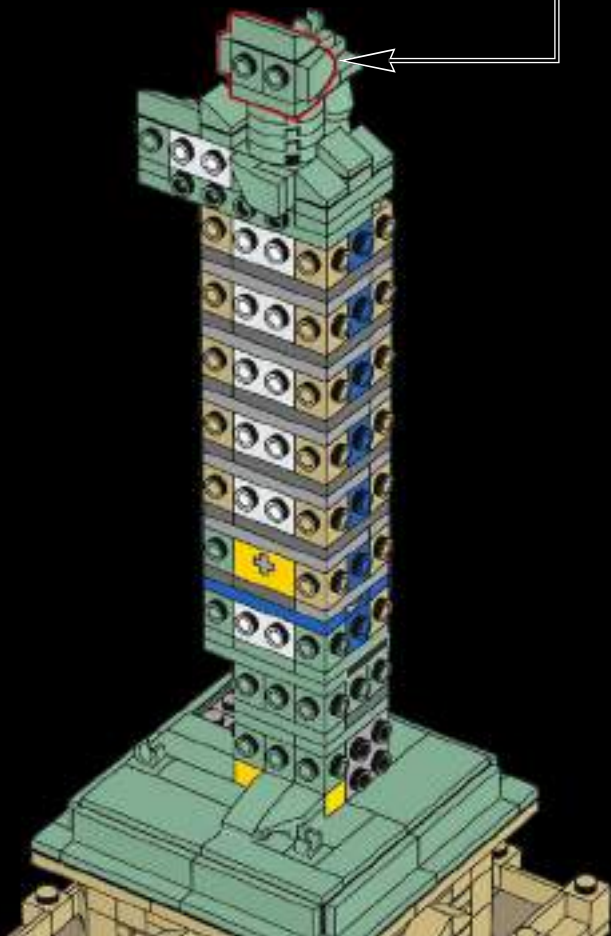

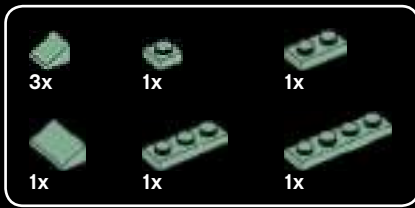

80

1



2



3



4



5

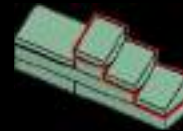

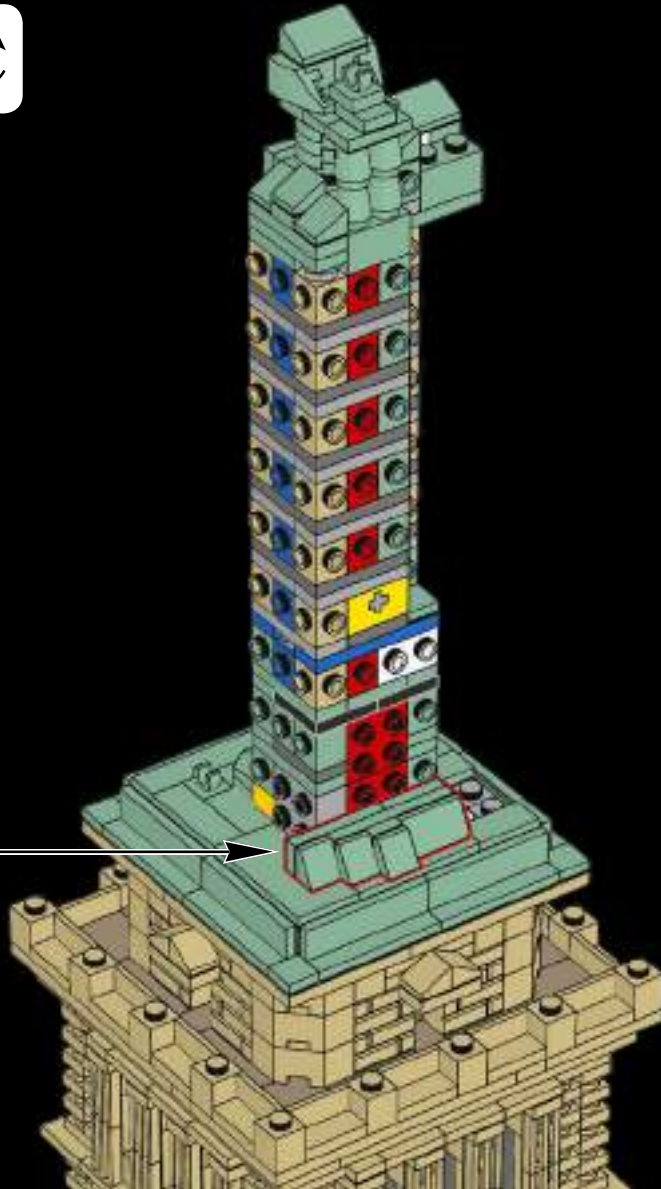



81

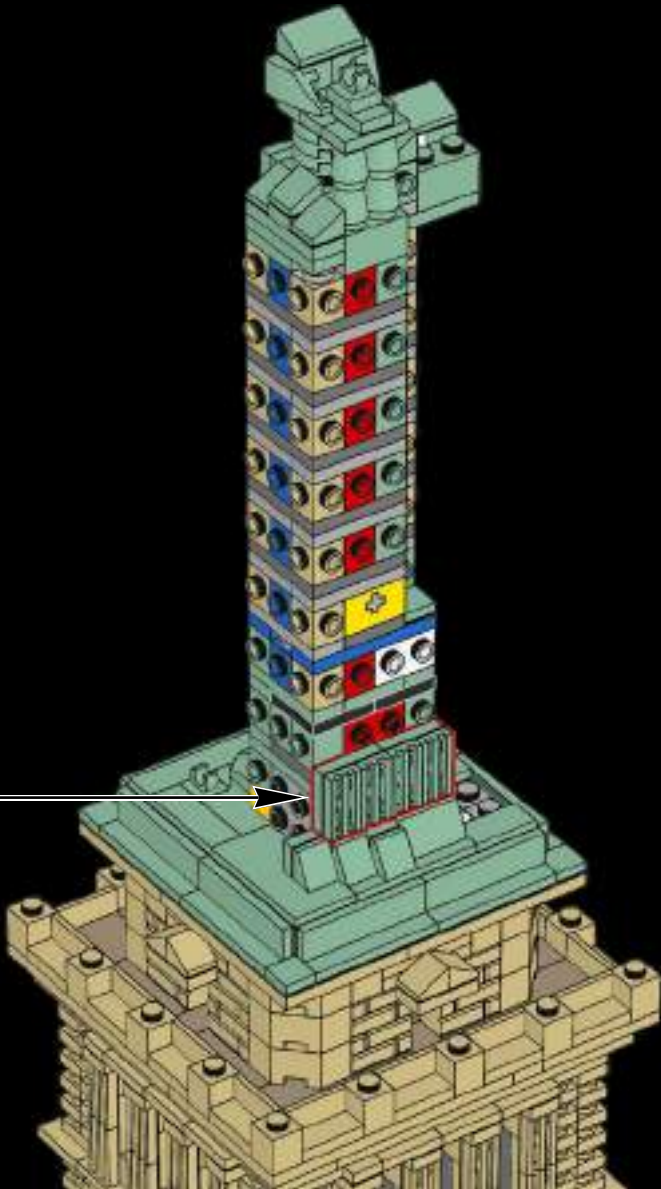
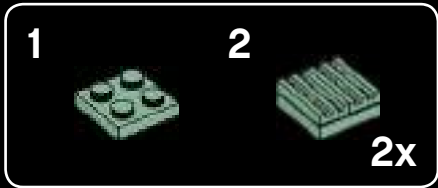



82

1



2



3



4



5



6



7

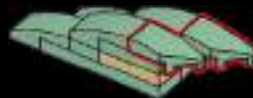

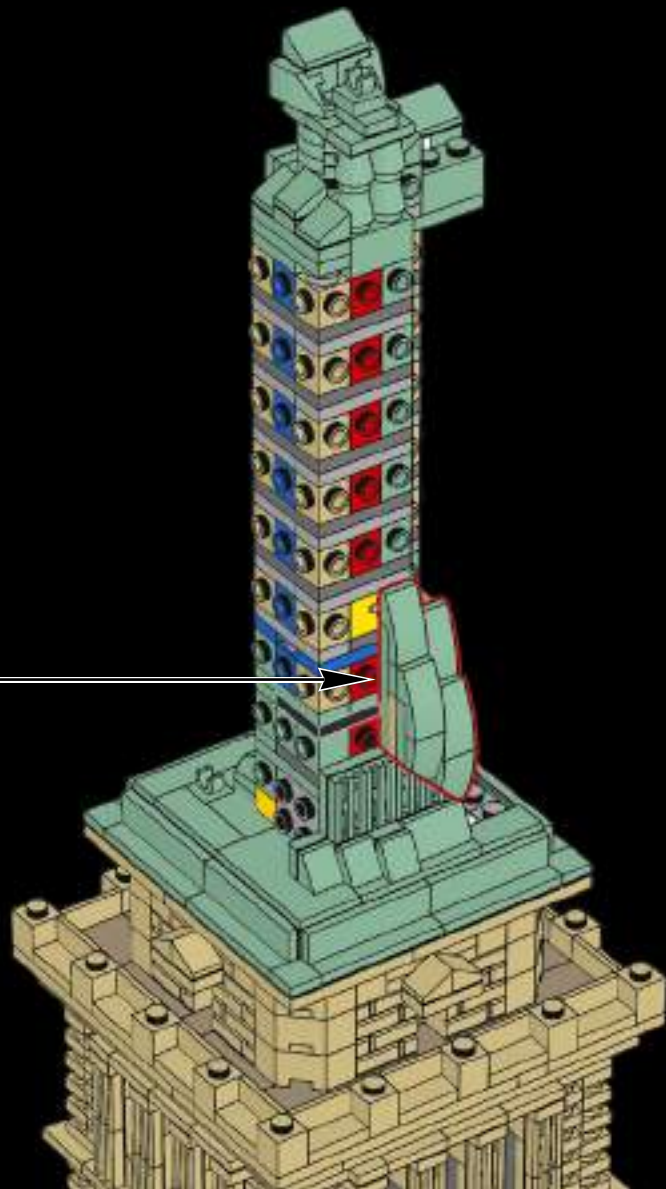

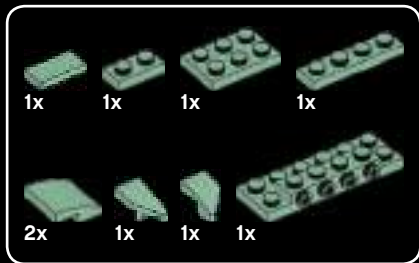

83

1



2



3



4



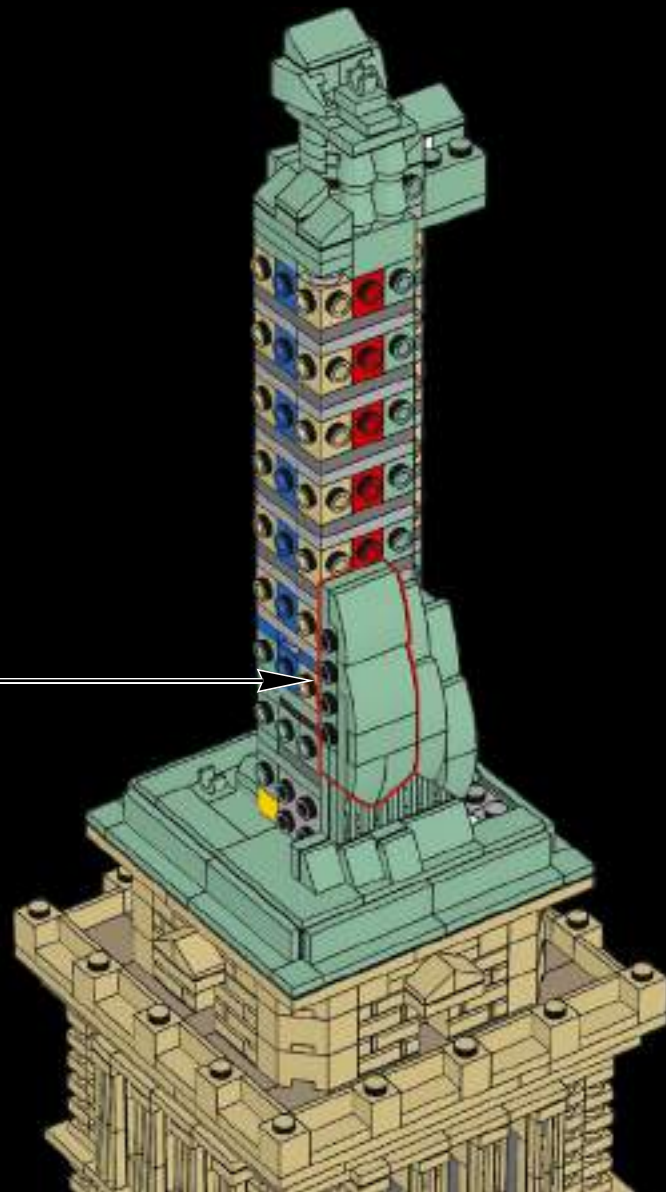



84

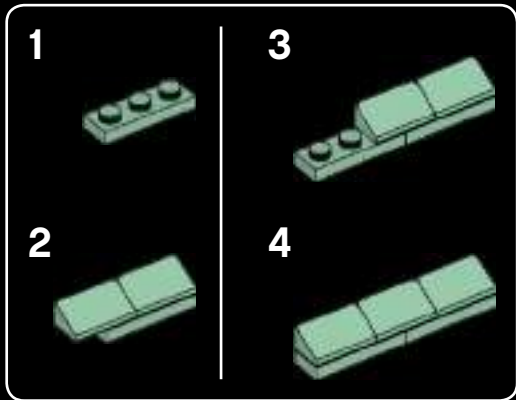
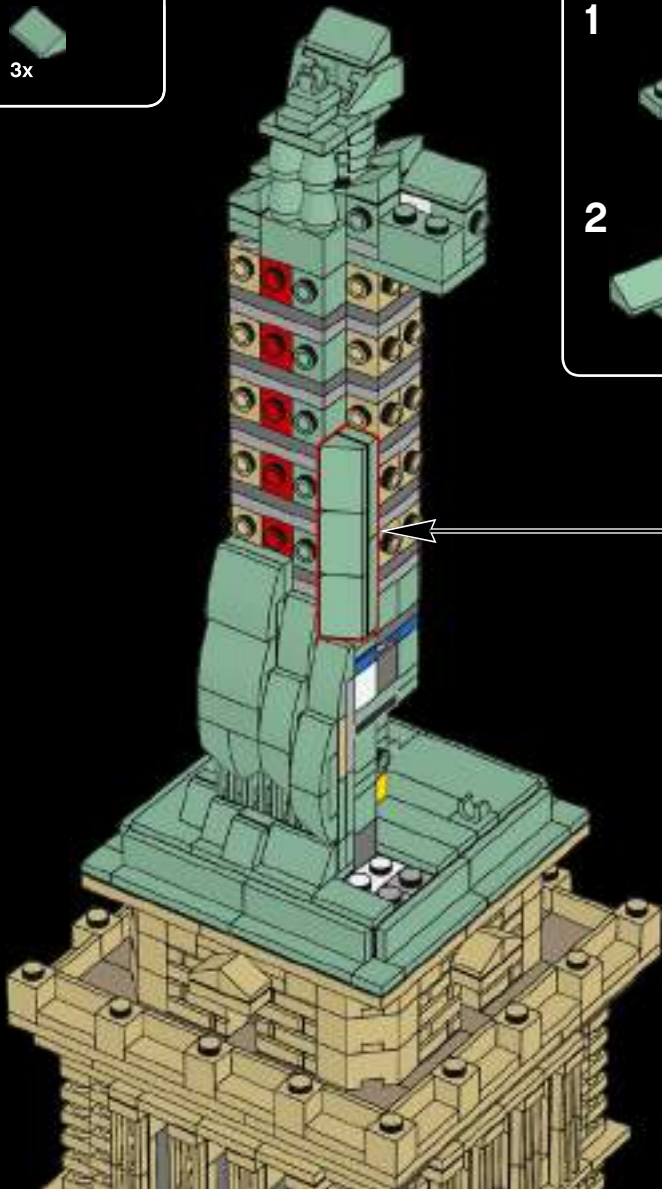



85

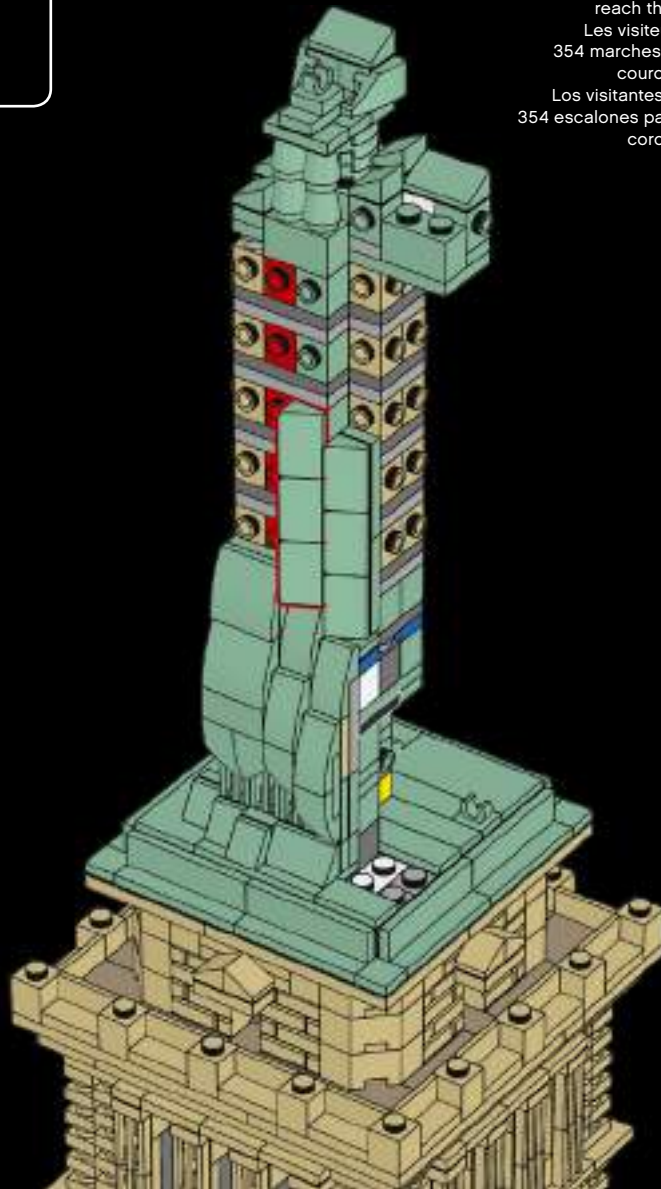

Visitors have to climb 354 stairs to reach the Statue's crown.
Les visiteurs doivent gravir 354 marches pour atteindre la couronne de la statue.
Los visitantes tienen que subir 354 escalones para llegar hasta la corona de la estatua.



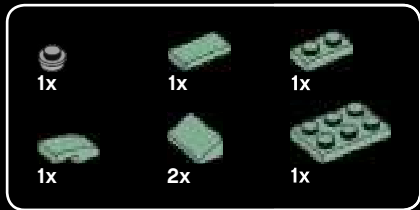

86

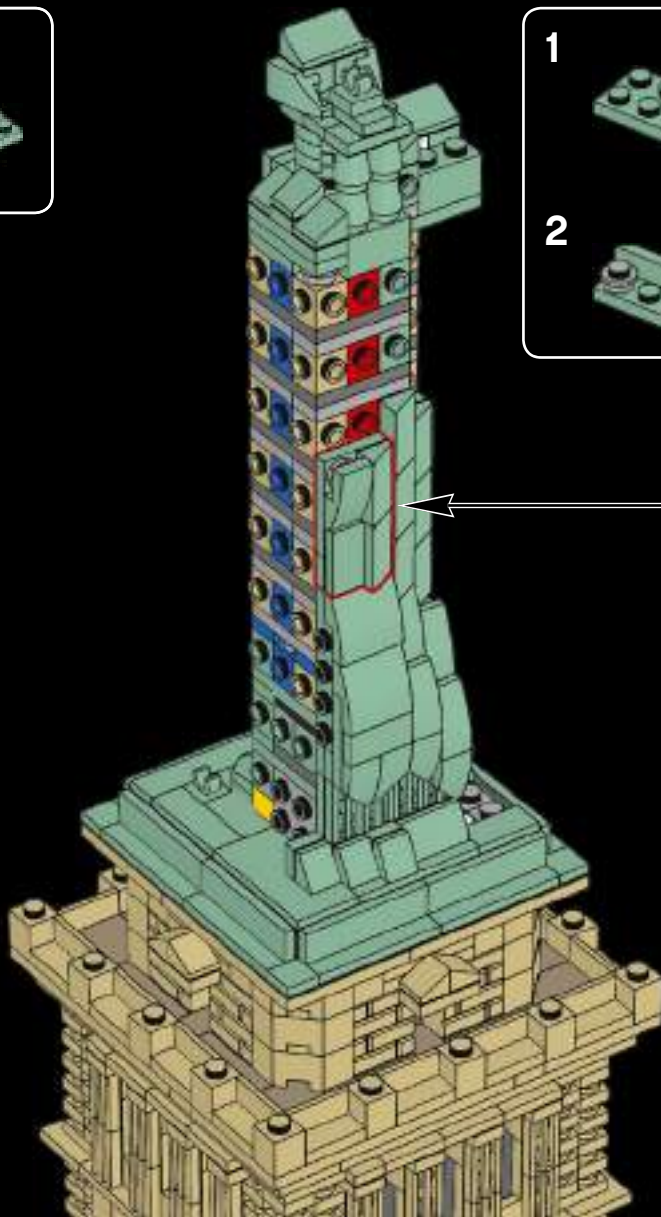
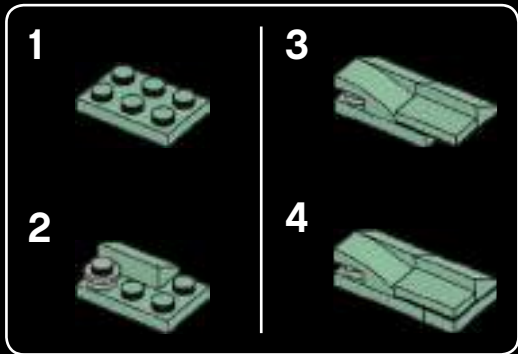



87

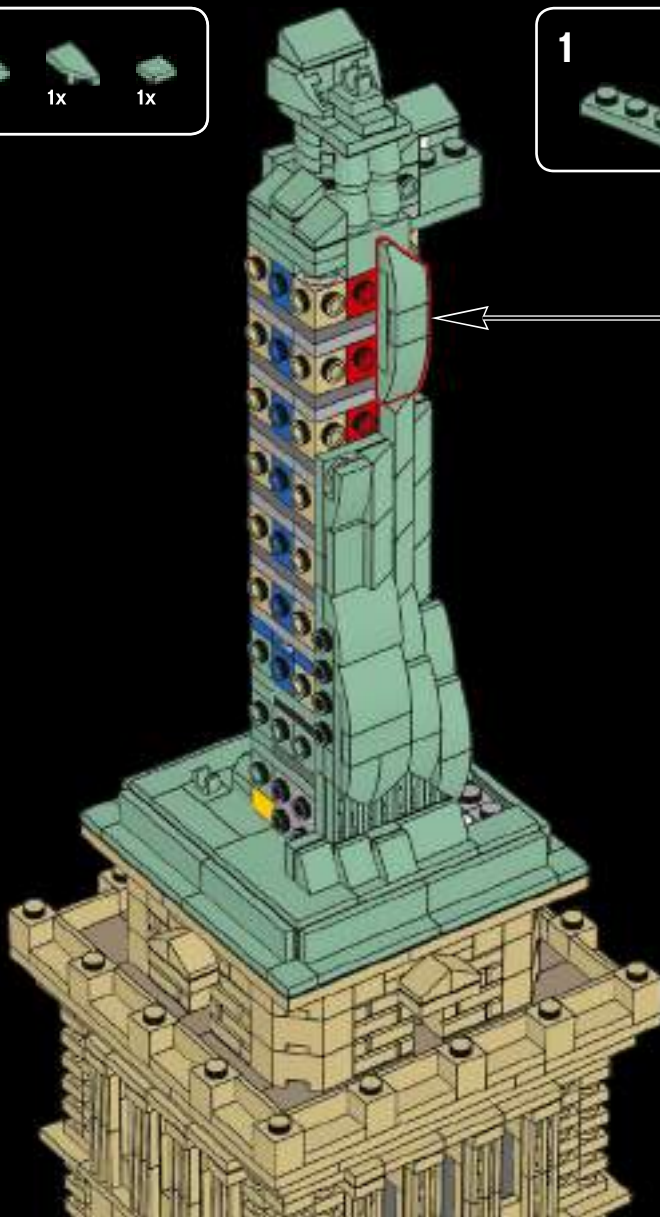

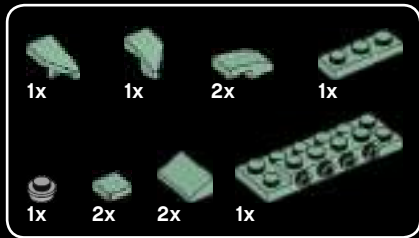

88

1



2



3



4



5



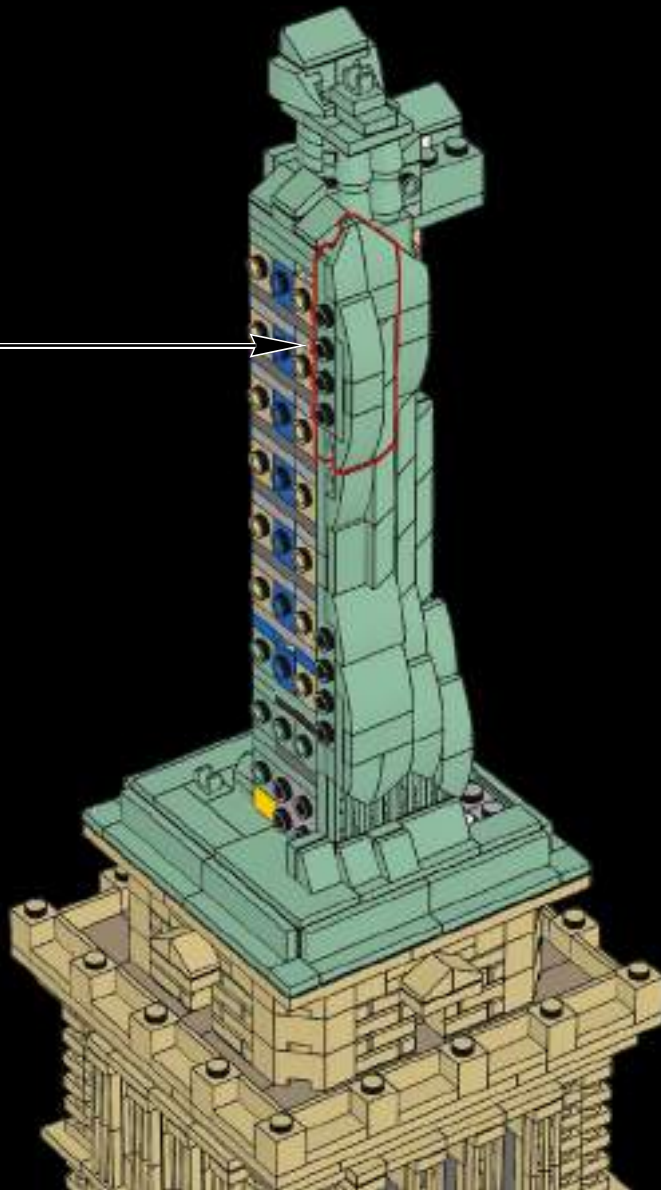



89

1



2



3

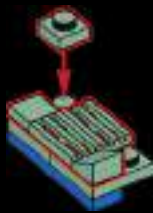

4

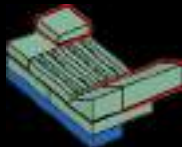

5

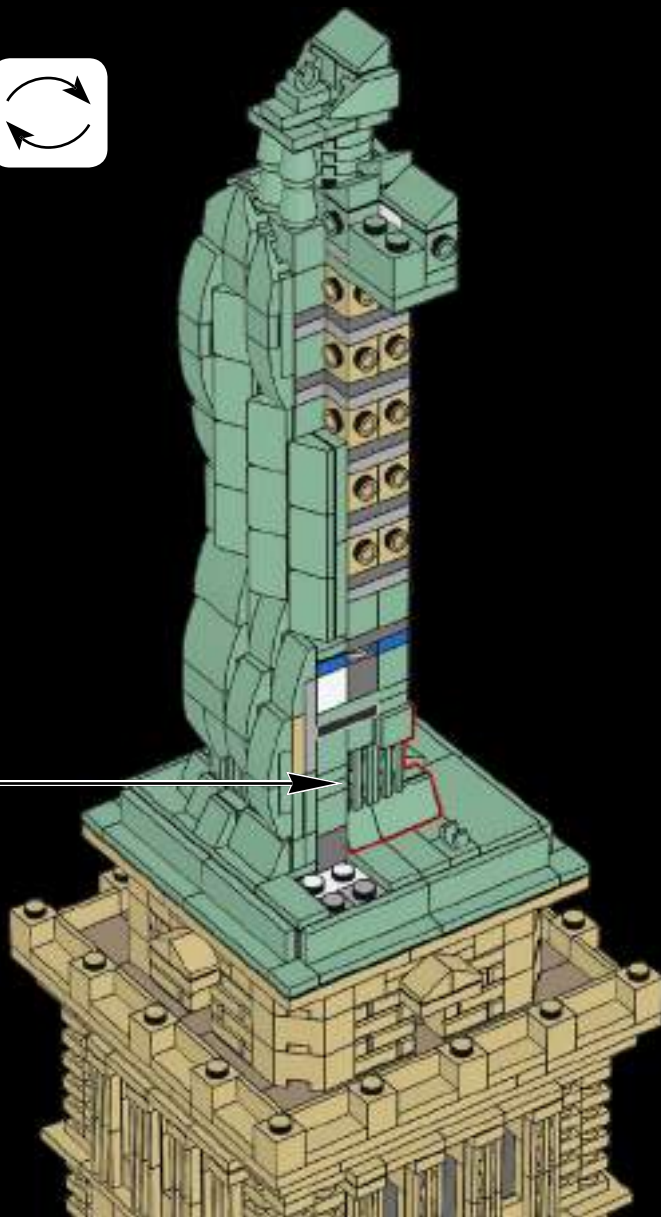
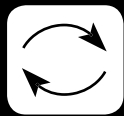
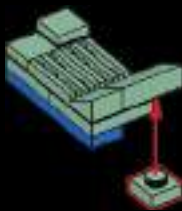



90



91



92

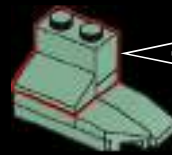
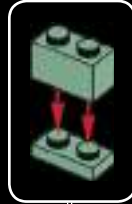

93

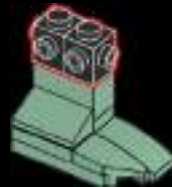



94

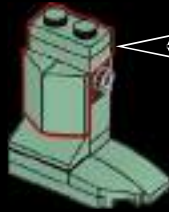
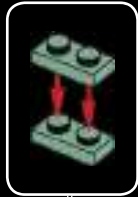

95



96

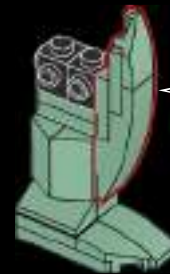



97

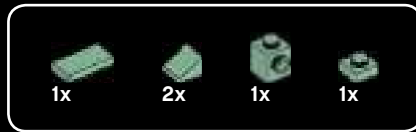
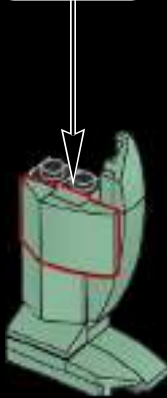
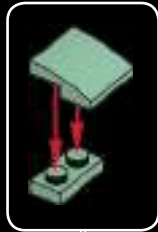

98

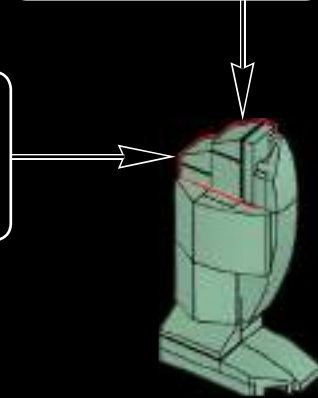
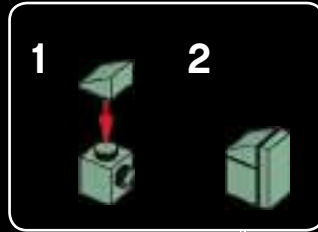



99

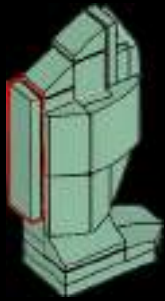

100





101

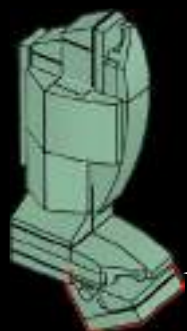
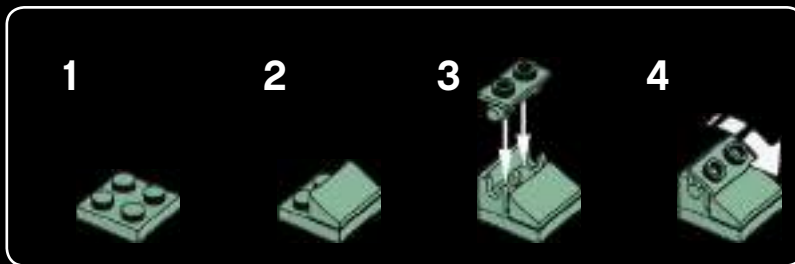



102

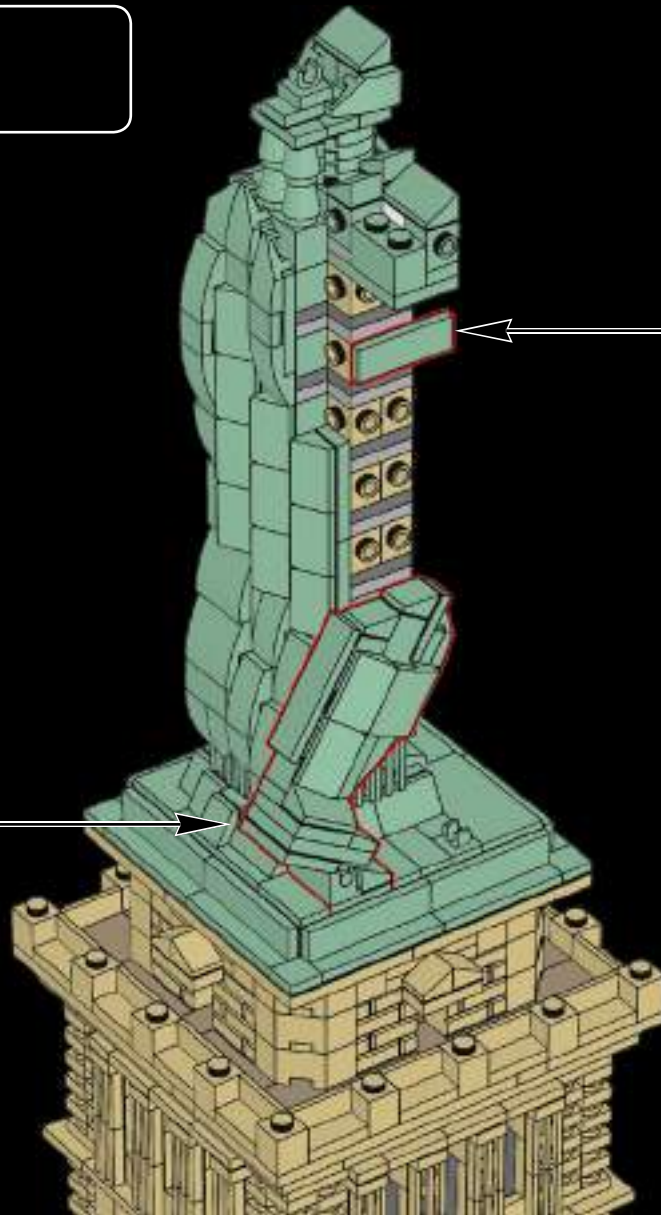

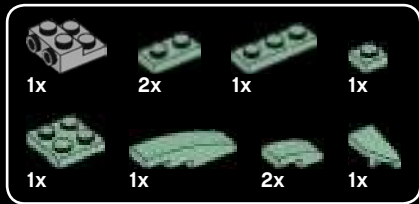

103

1



2



3



4



5

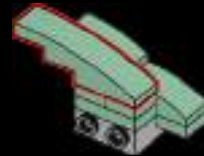

6

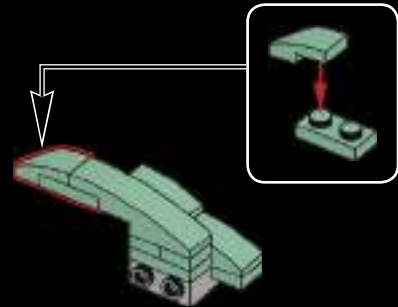

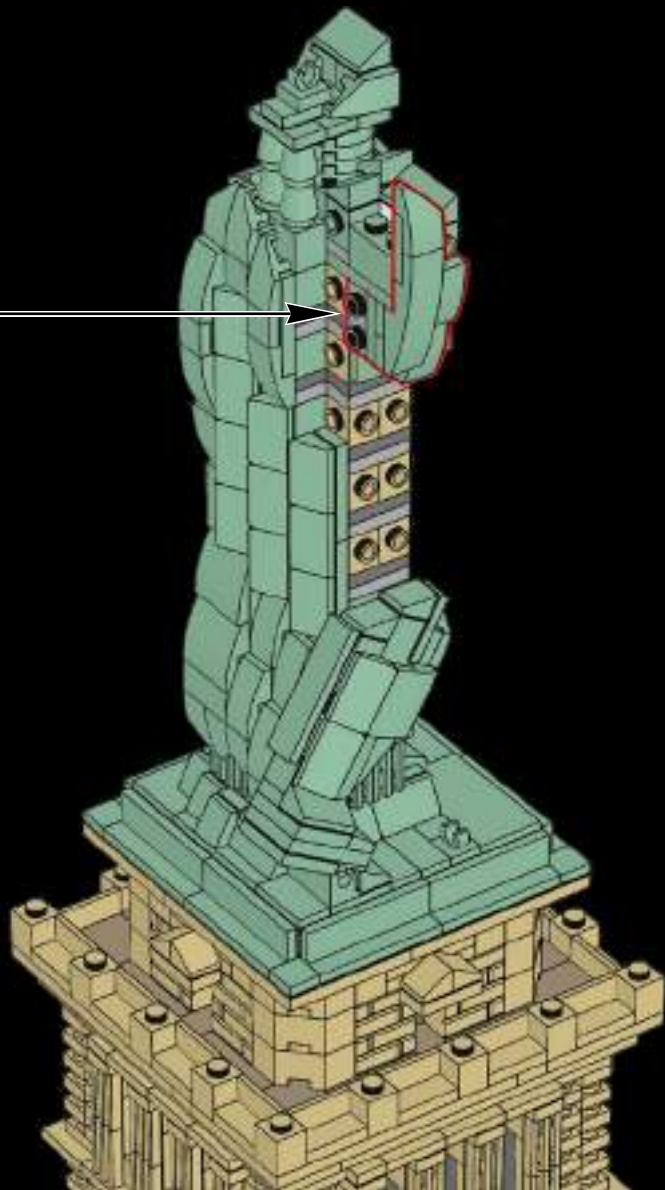

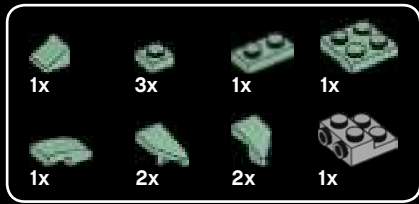

104

1



2



3



4

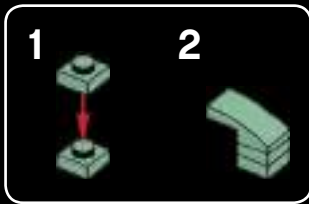

5



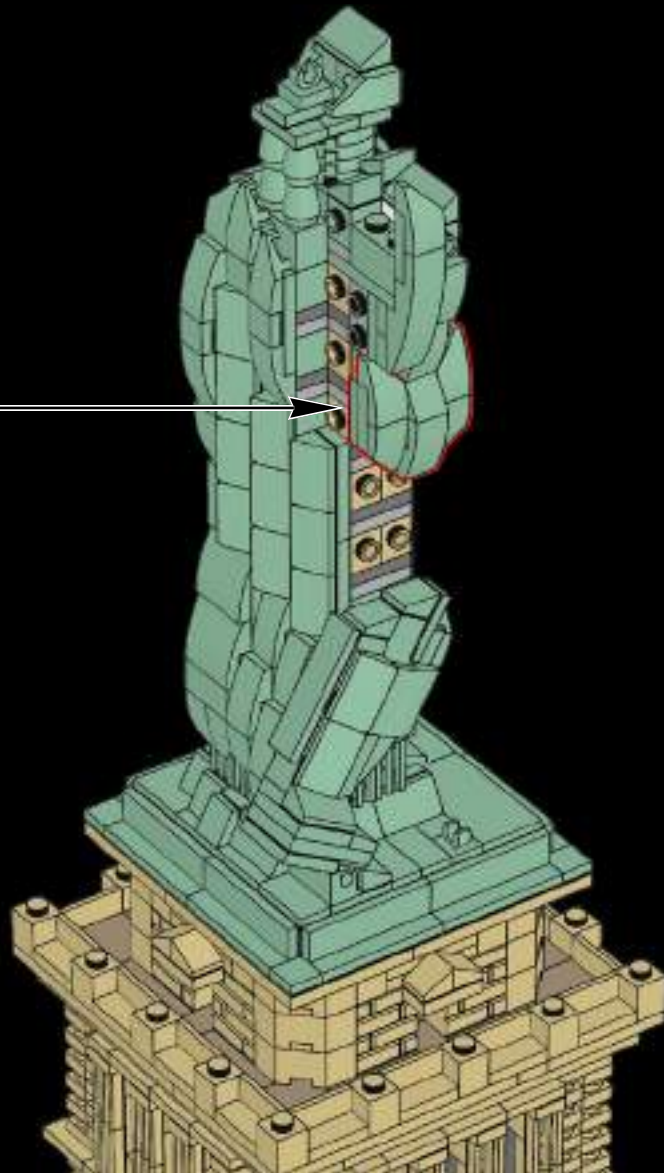

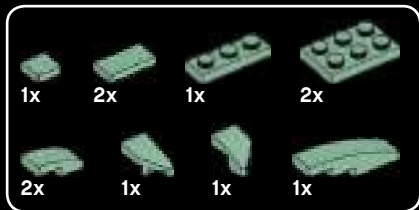

105

1



2



3



4



5



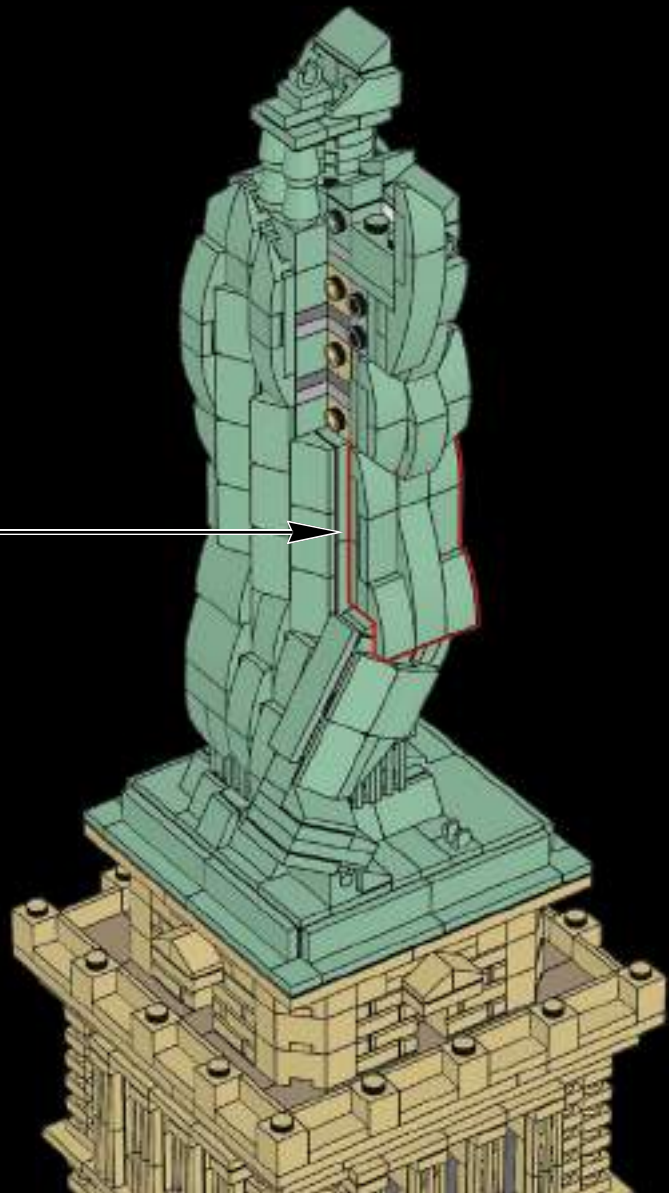

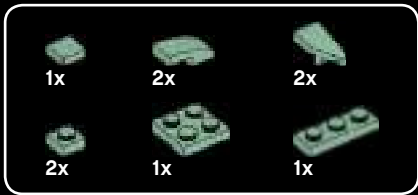

106

1



2



3

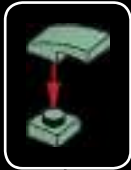

4

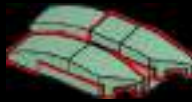

When the Statue was first erected in 1886 it was the tallest iron structure in the world.
Lorsque la statue a été érigée en 1886, il s'agissait de la plus haute structure en fer dans le monde.
Cuando se erigió en 1886, la estatua era la estructura de hierro más alta del mundo.

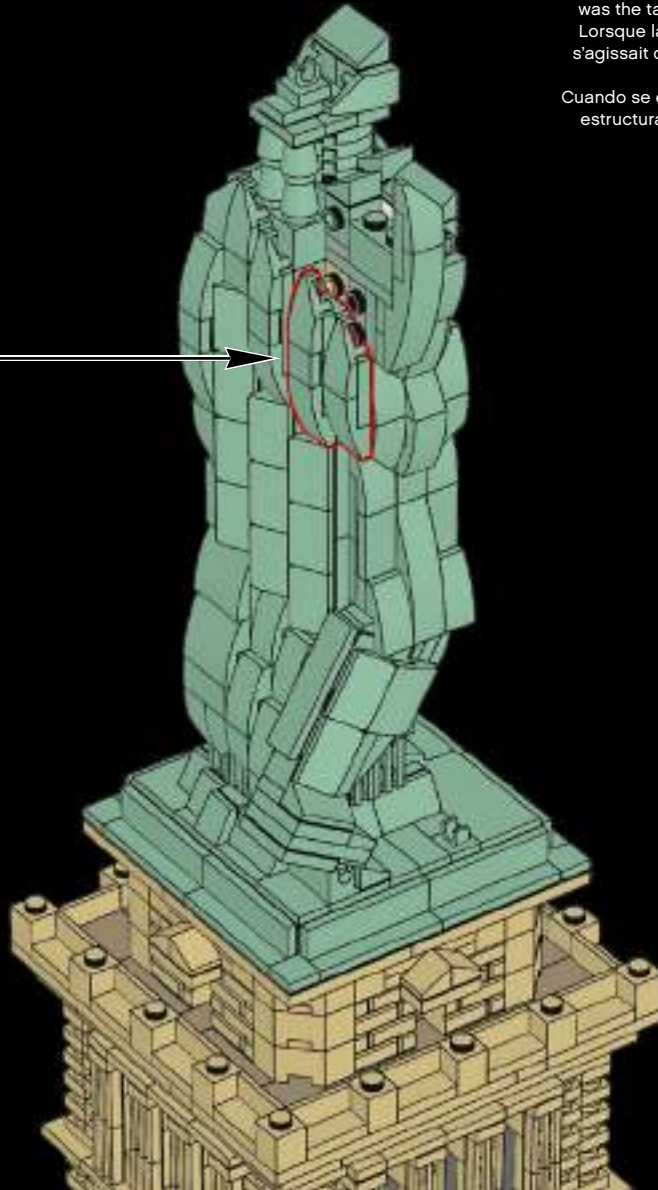



107

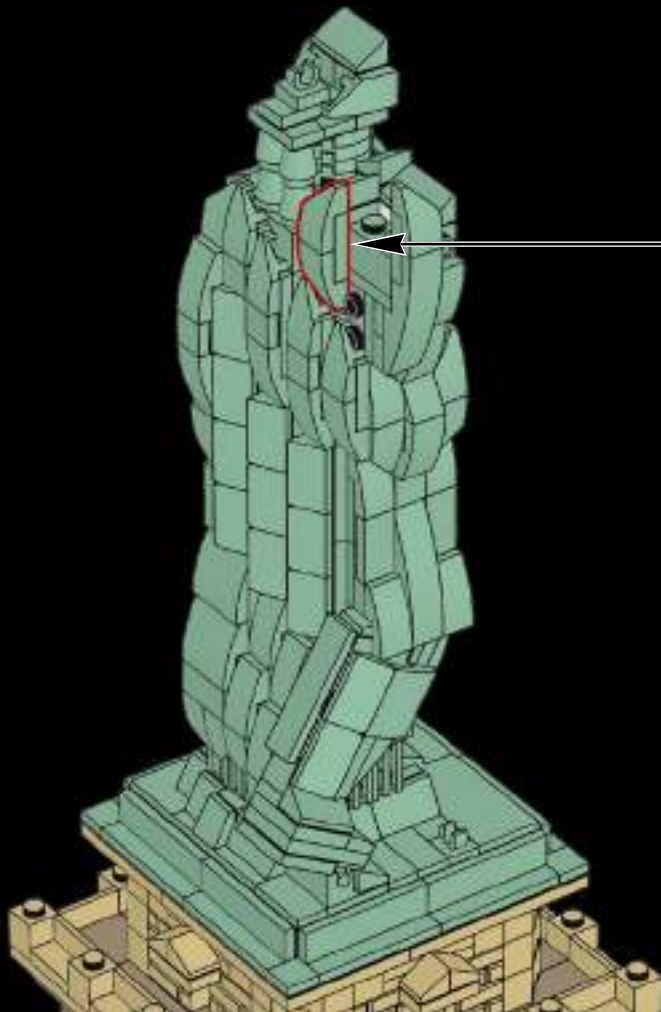



108

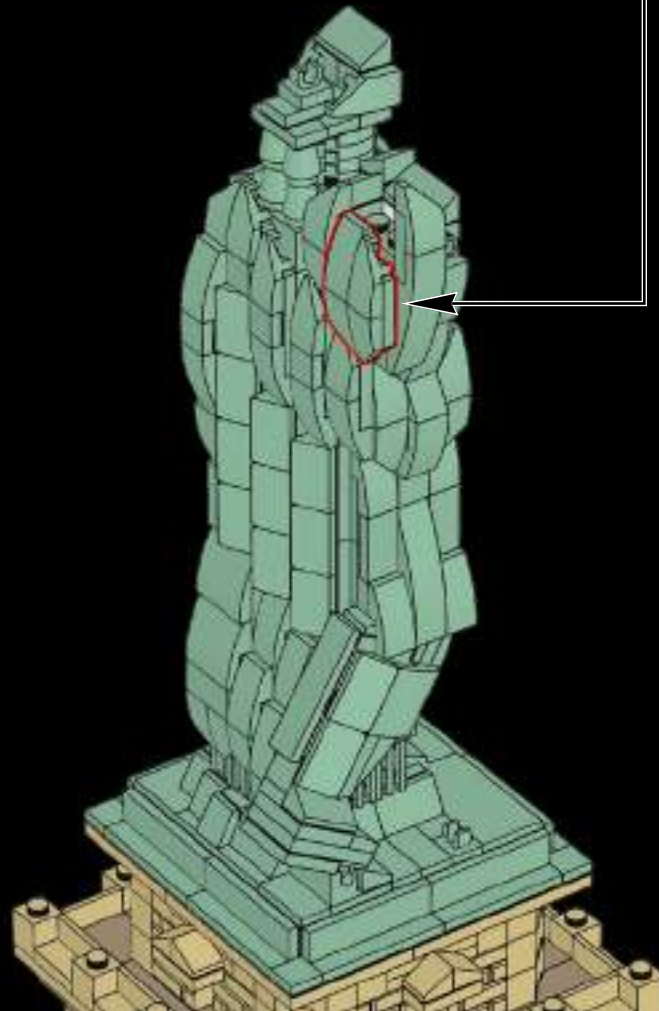

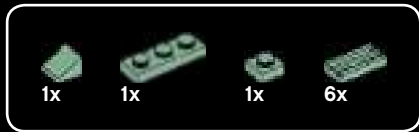

109

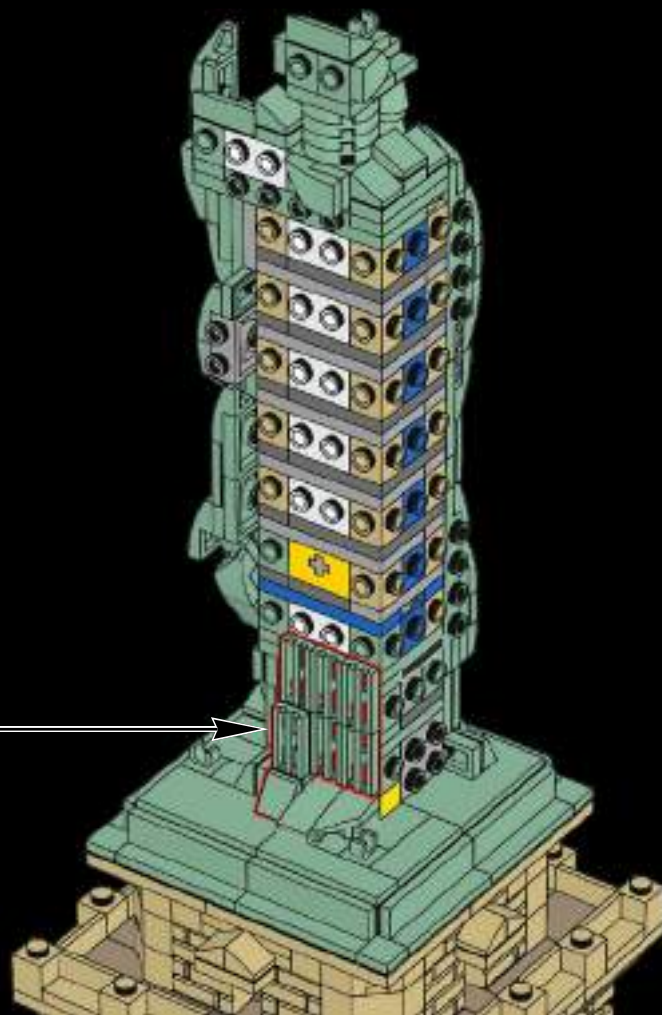



110

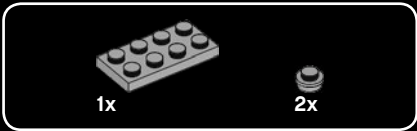
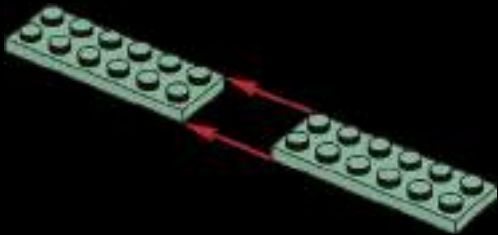

111



112

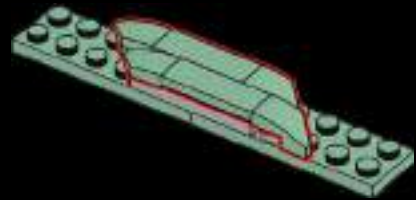

113

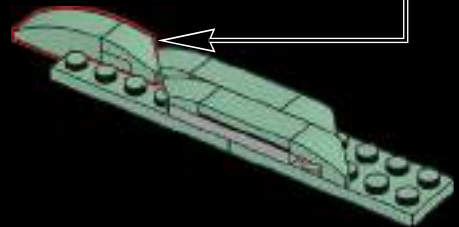

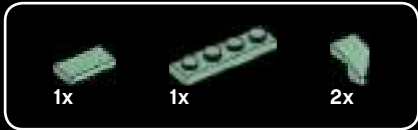

114

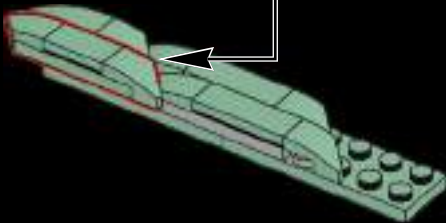
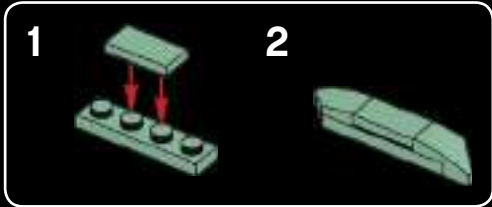

115

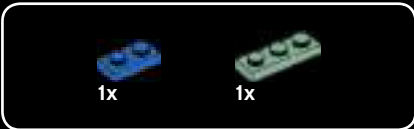

116

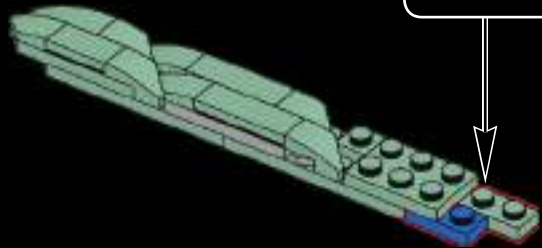



117

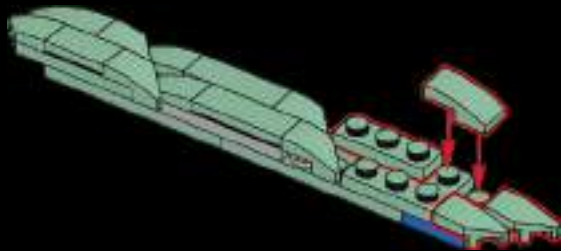

118

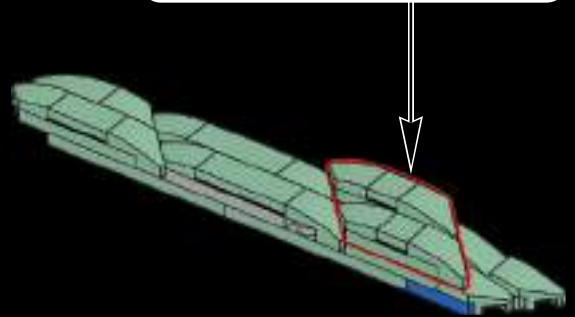
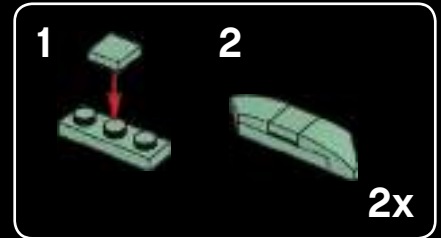

119

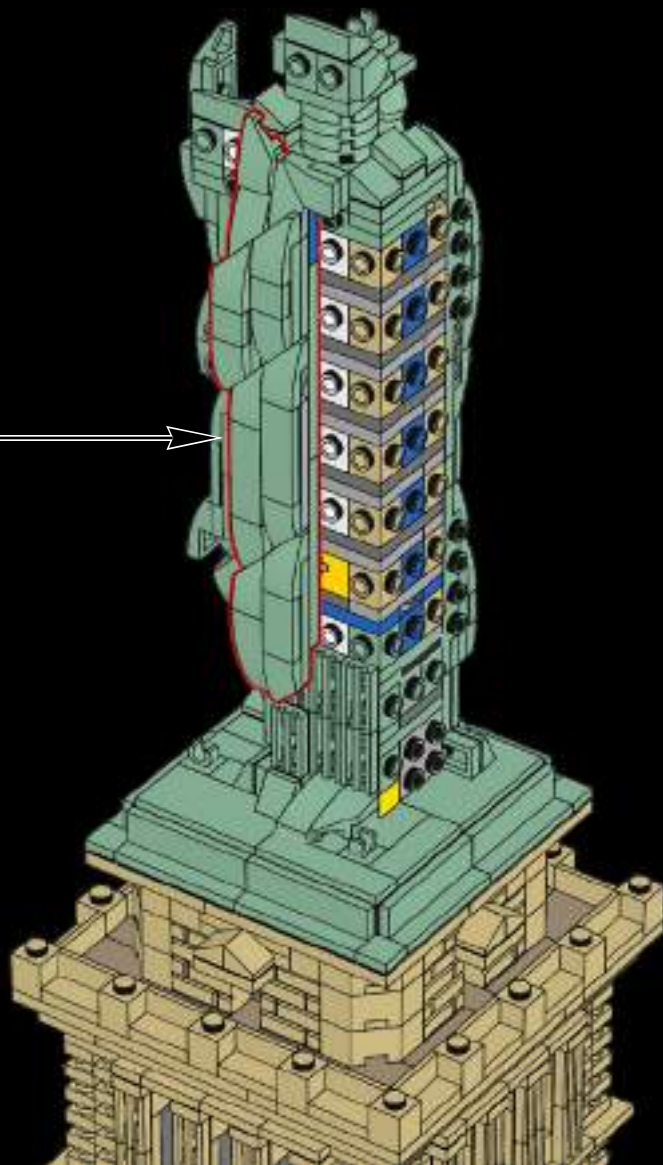



120

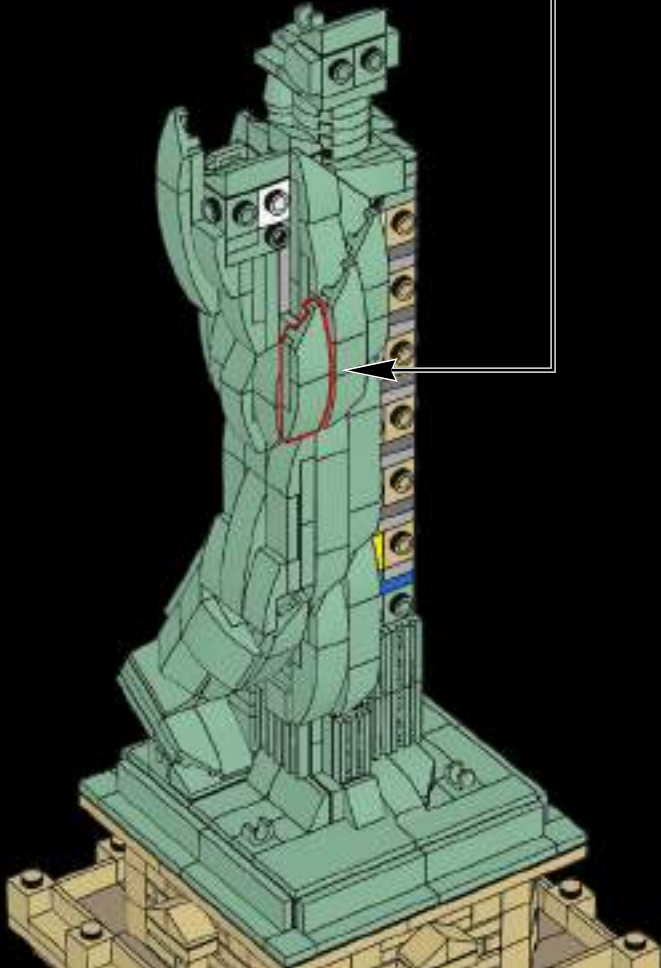

121

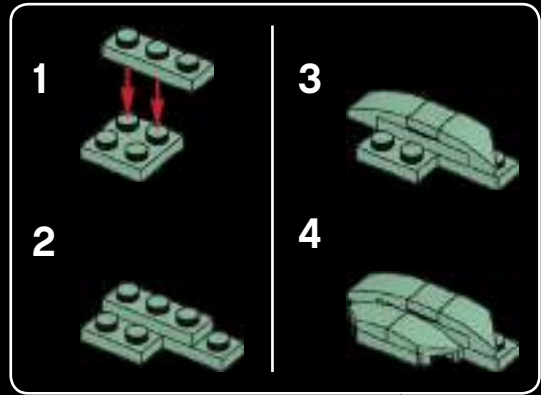
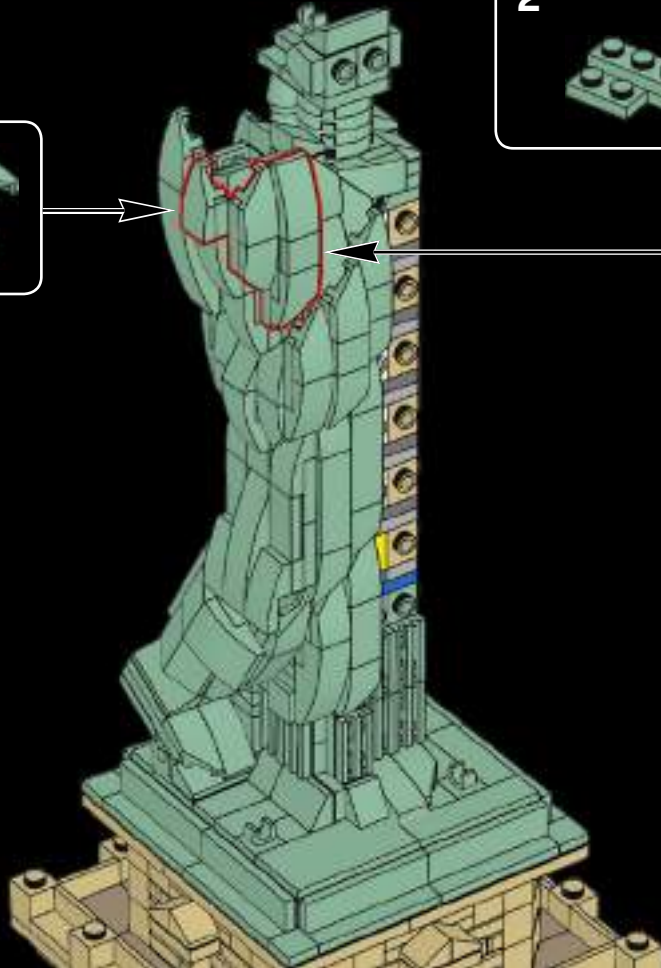
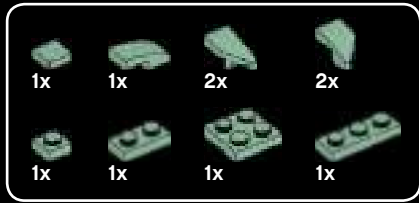



122

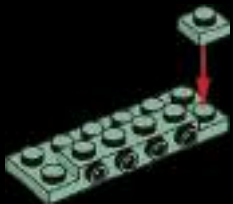

123

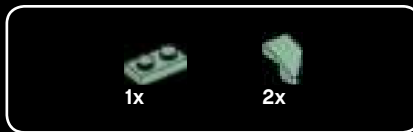
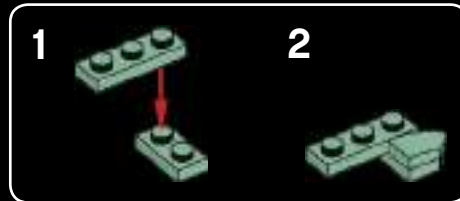

124

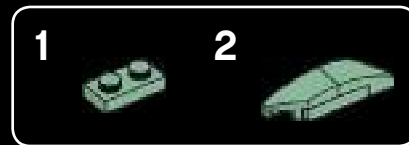

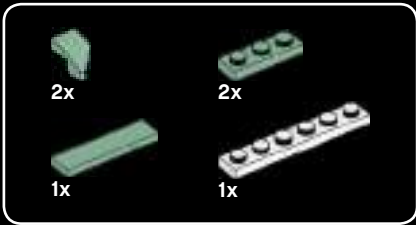

125

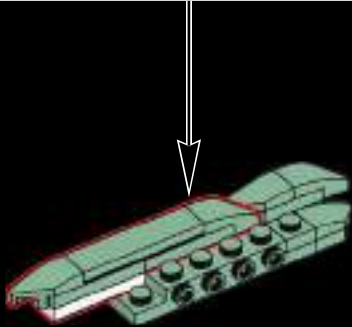
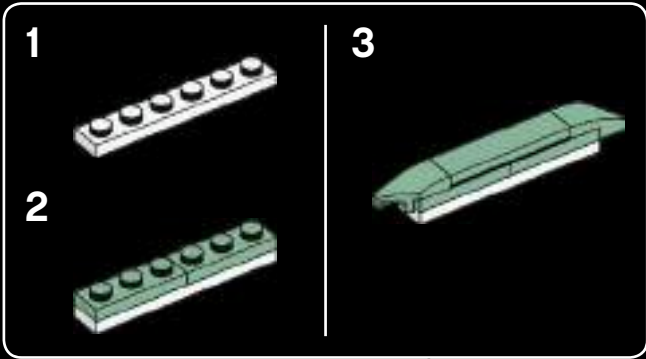

126





127

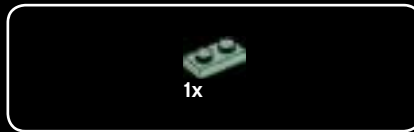
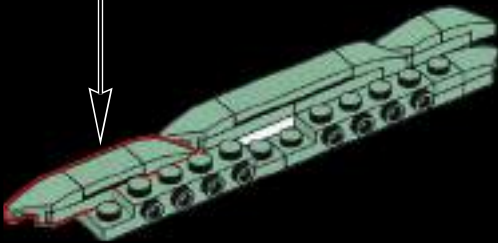
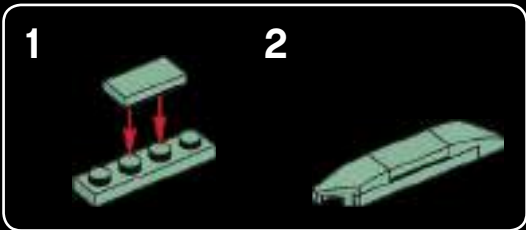

128



129

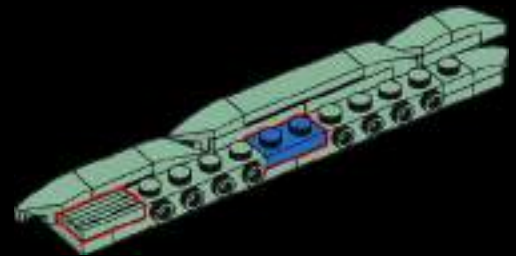

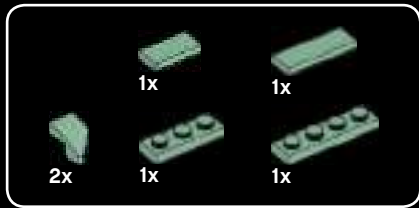

130

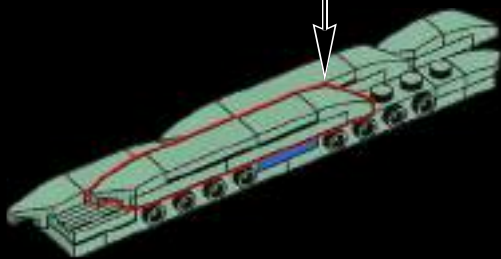
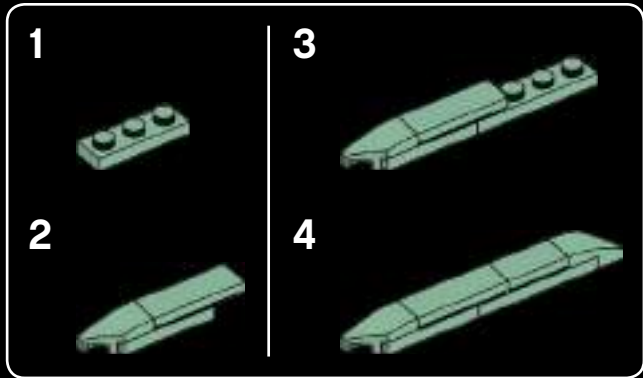

131

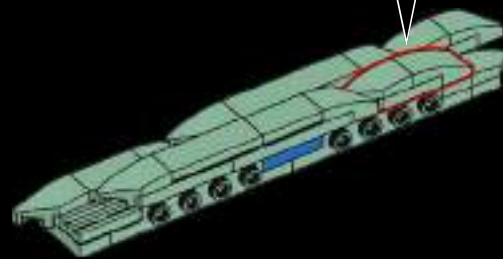
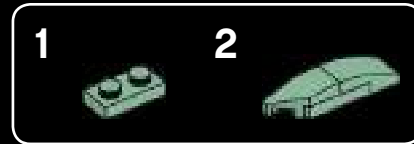

132

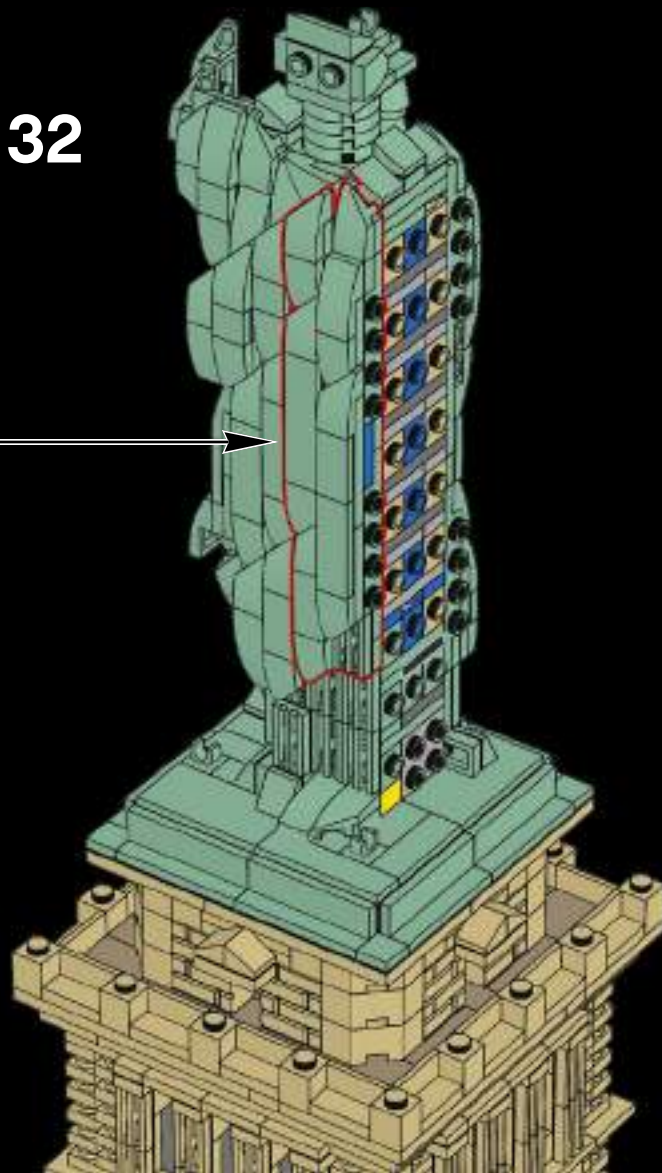

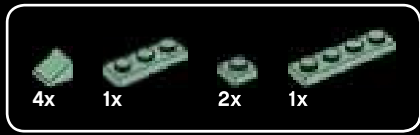

133

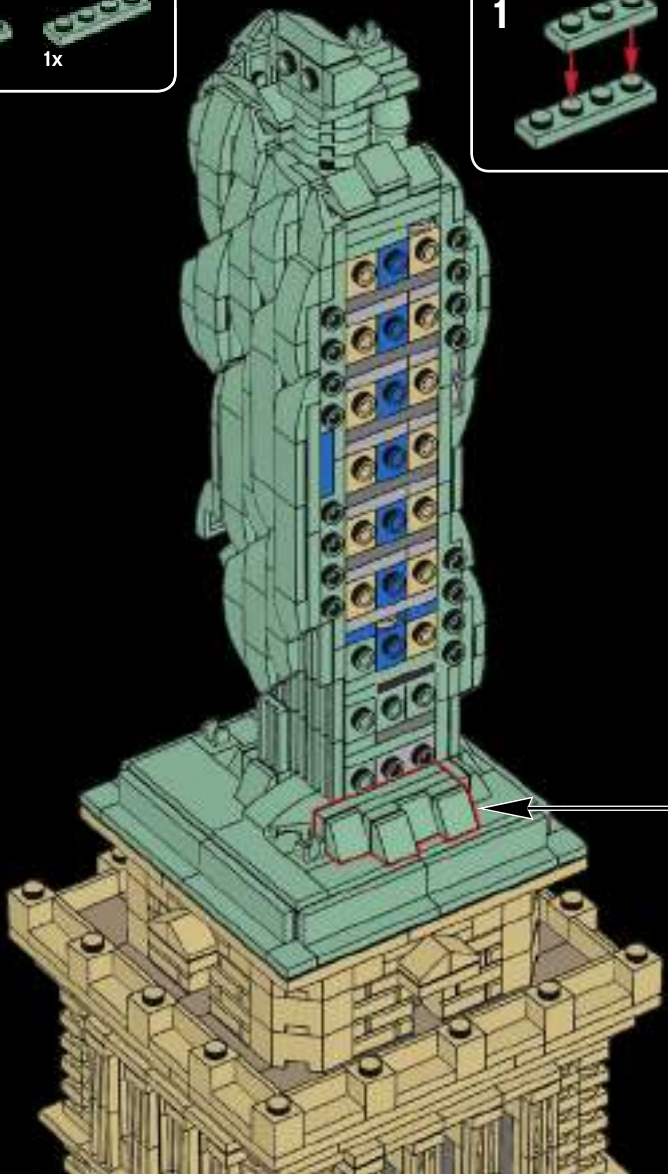
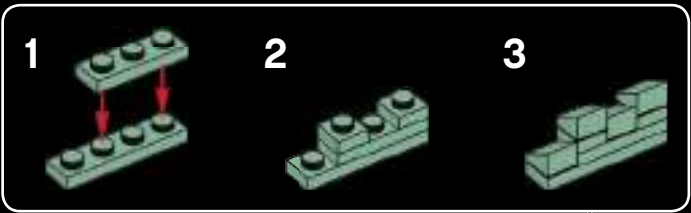

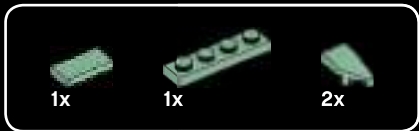

134

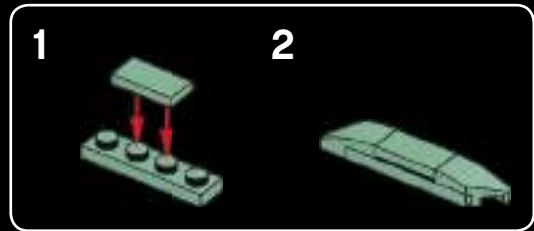
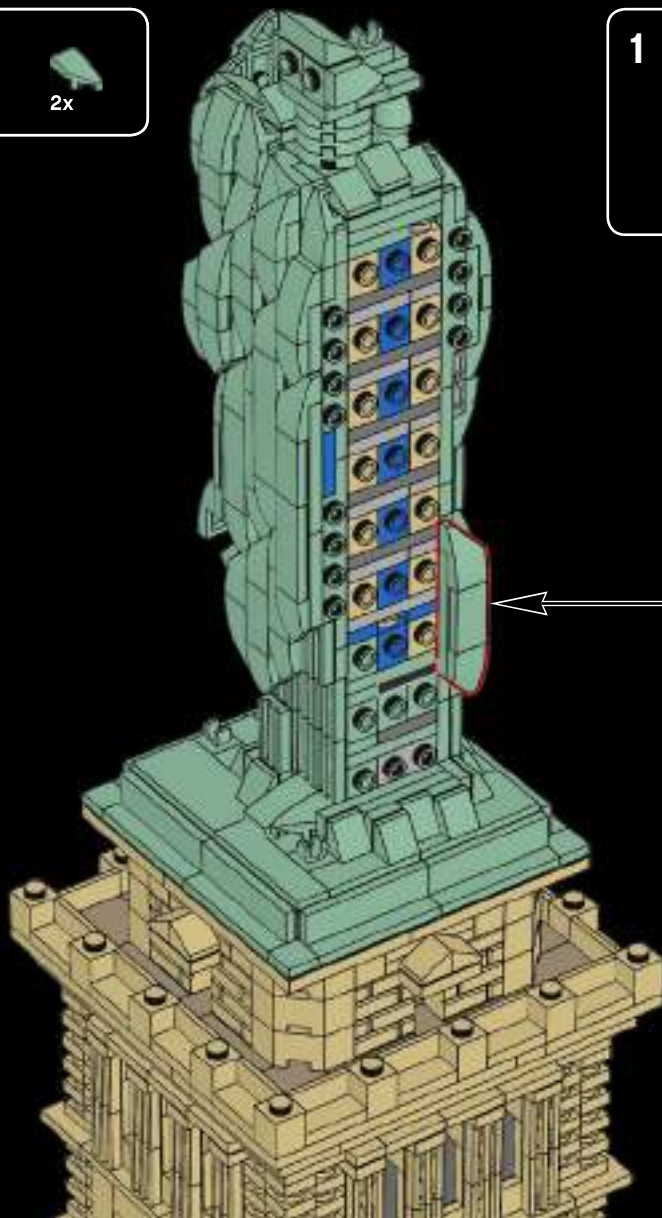



135

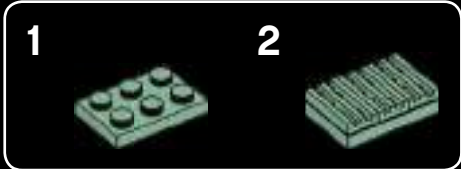
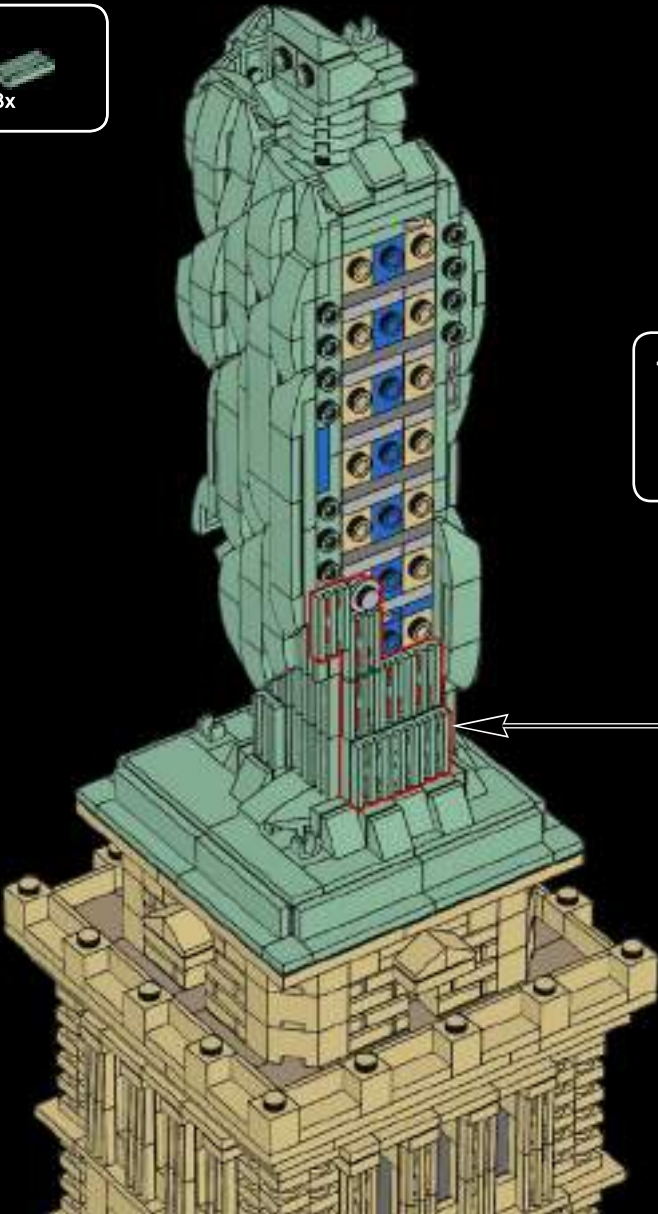

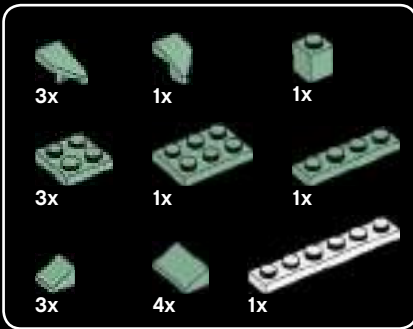

136

1



2



3



4

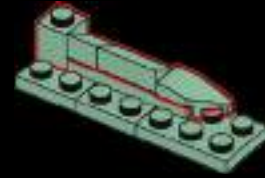

5

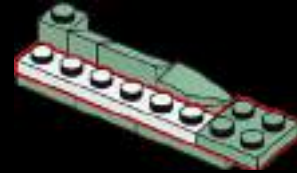

6

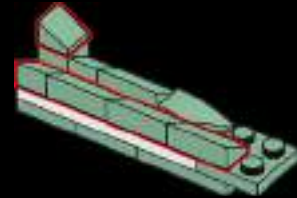

7

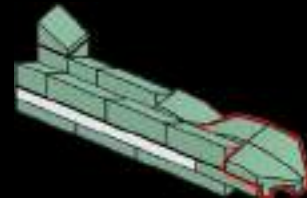

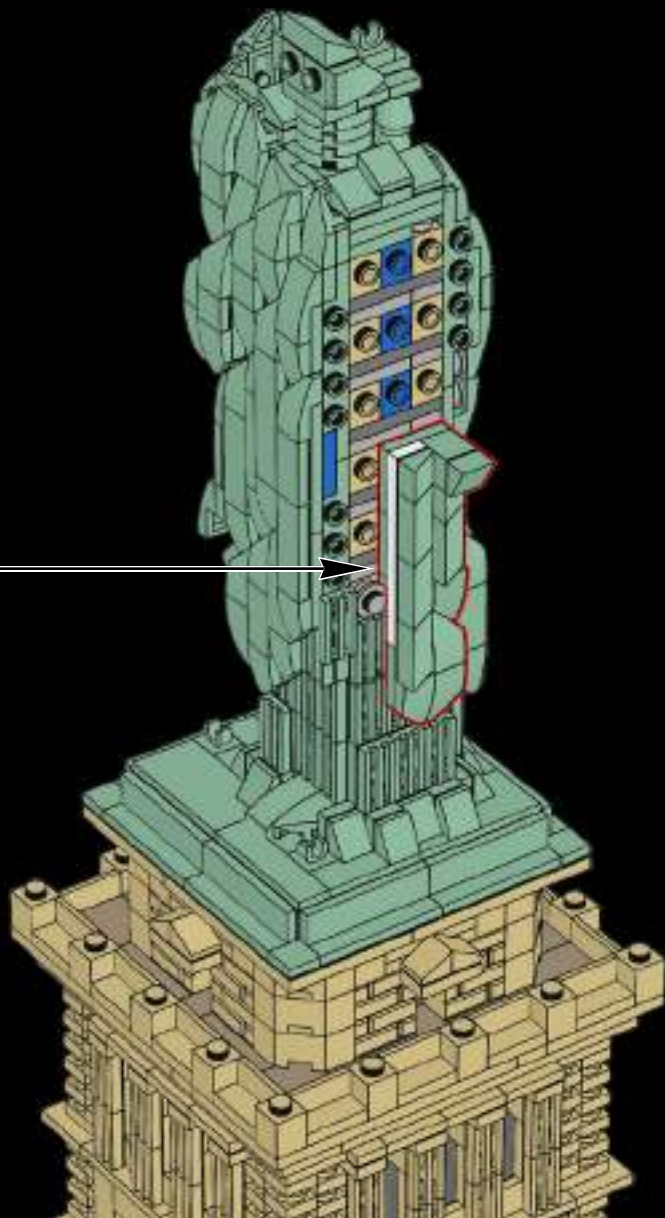

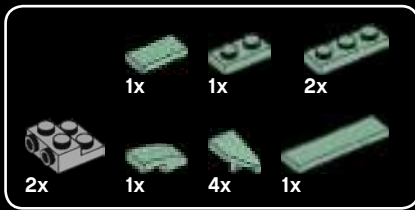

137

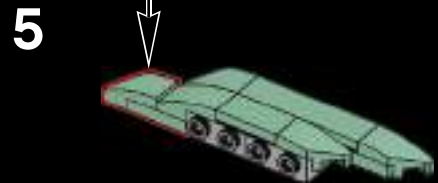
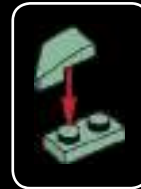
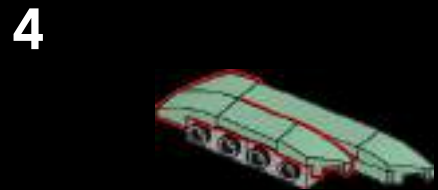
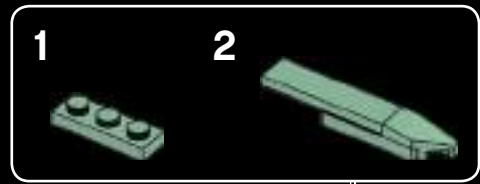
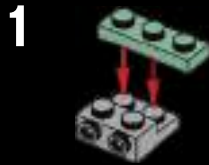

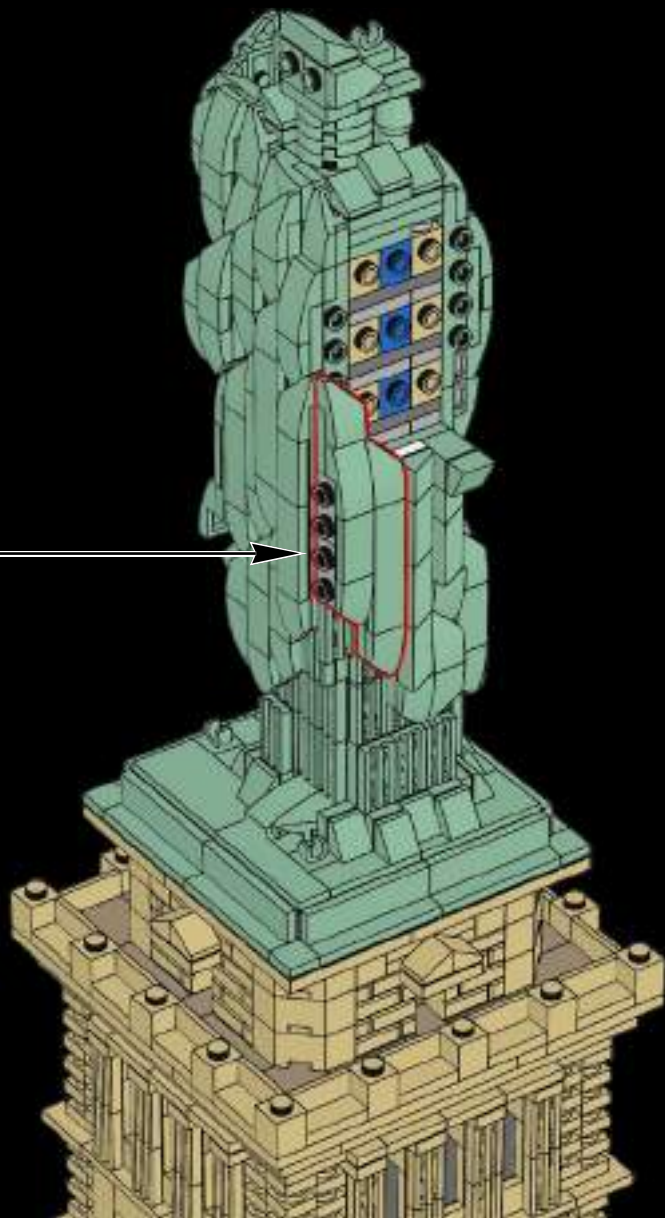



138

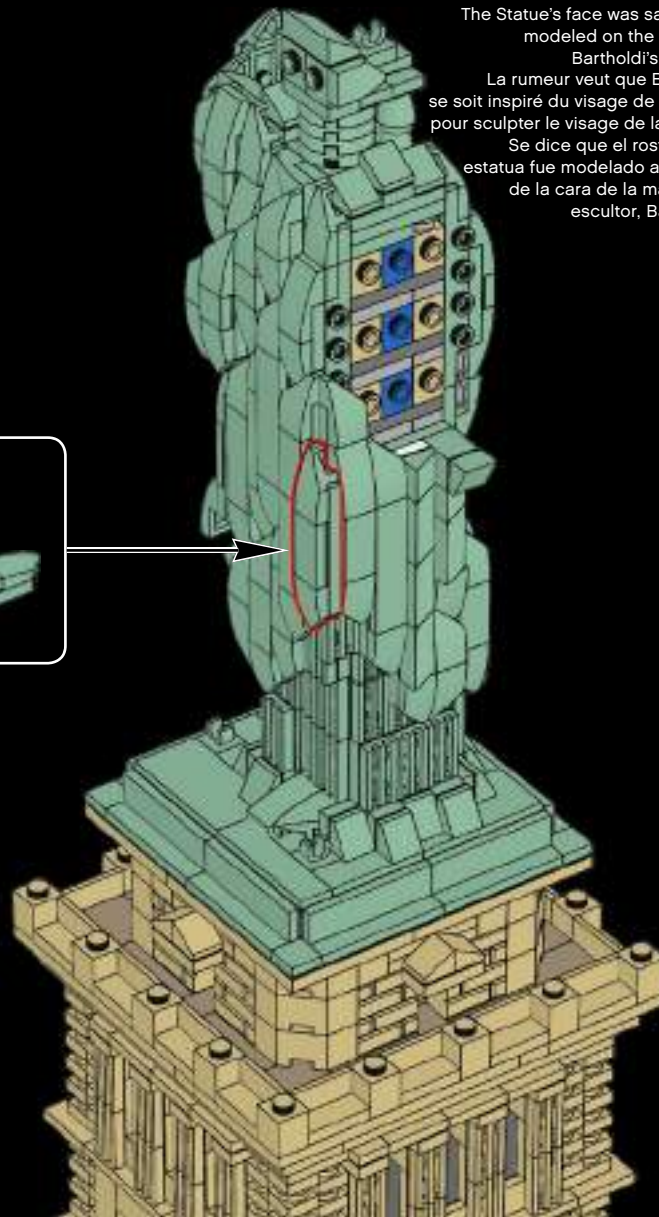
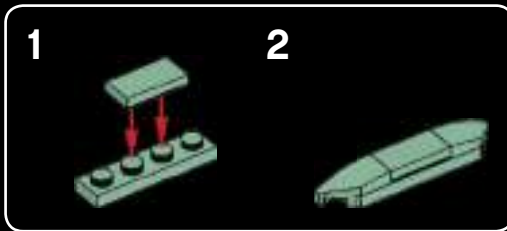

The Statue's face was said to be modeled on the sculptor Bartholdi's mother.

La rumeur veut que Bartholdi se soit inspiré du visage de sa mère pour sculpter le visage de la statue.

Se dice que el rostro de la estatua fue modelado a imagen de la cara de la madre del escultor, Bartholdi.



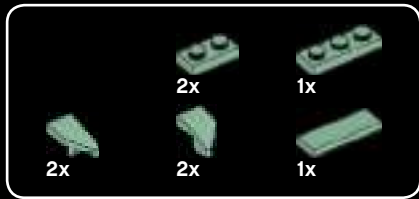

139

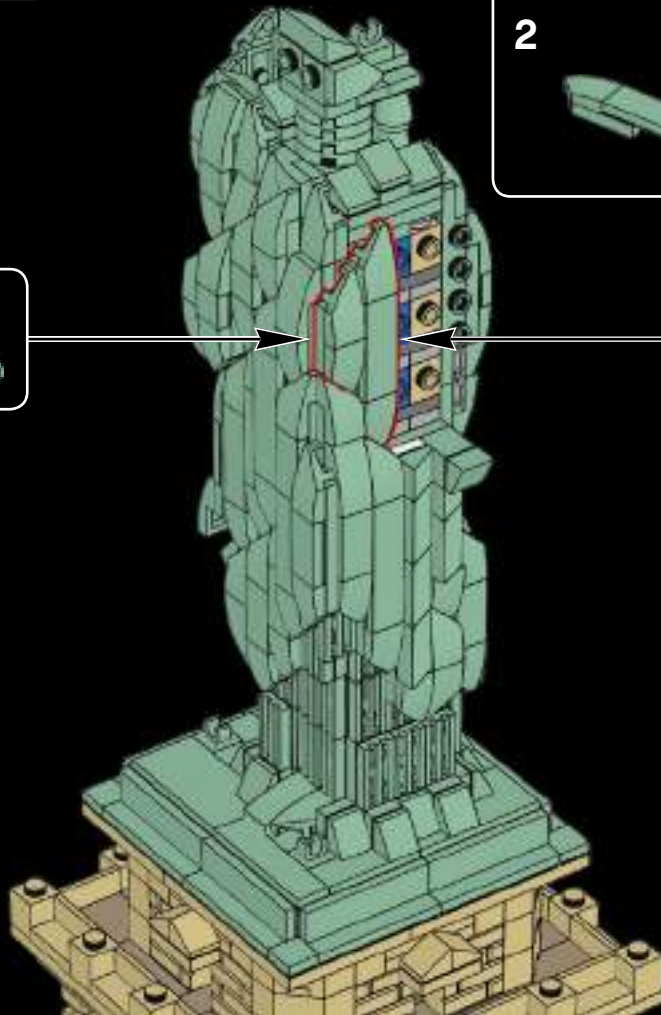
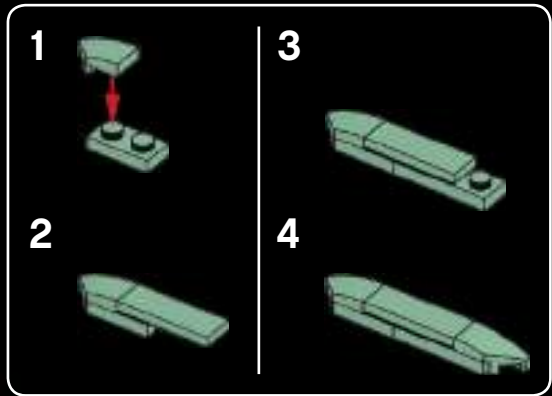



140

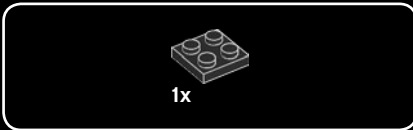

141

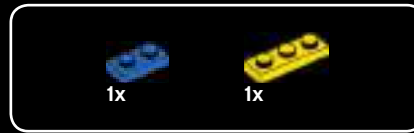

142

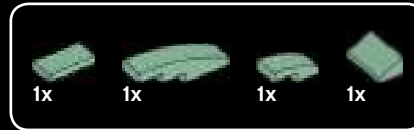
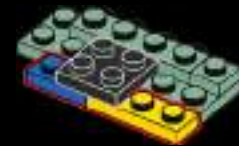

143

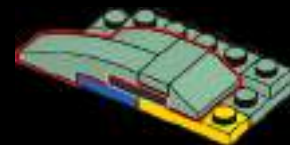



144

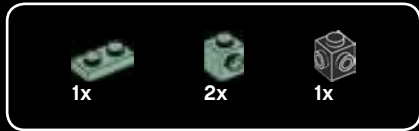
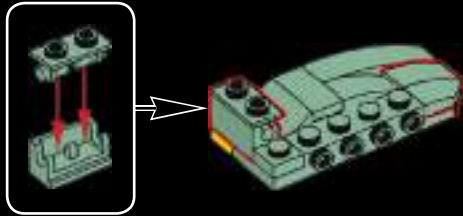

145

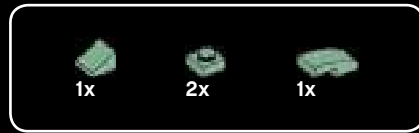

146

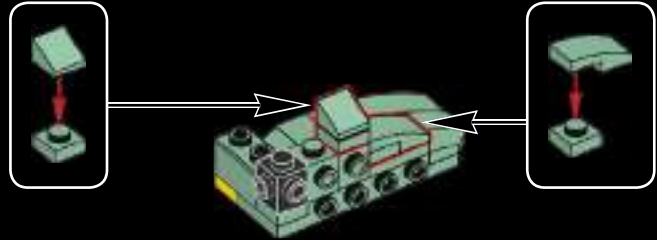

147

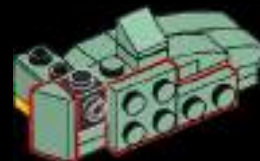



148

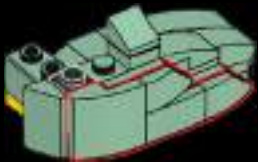

149

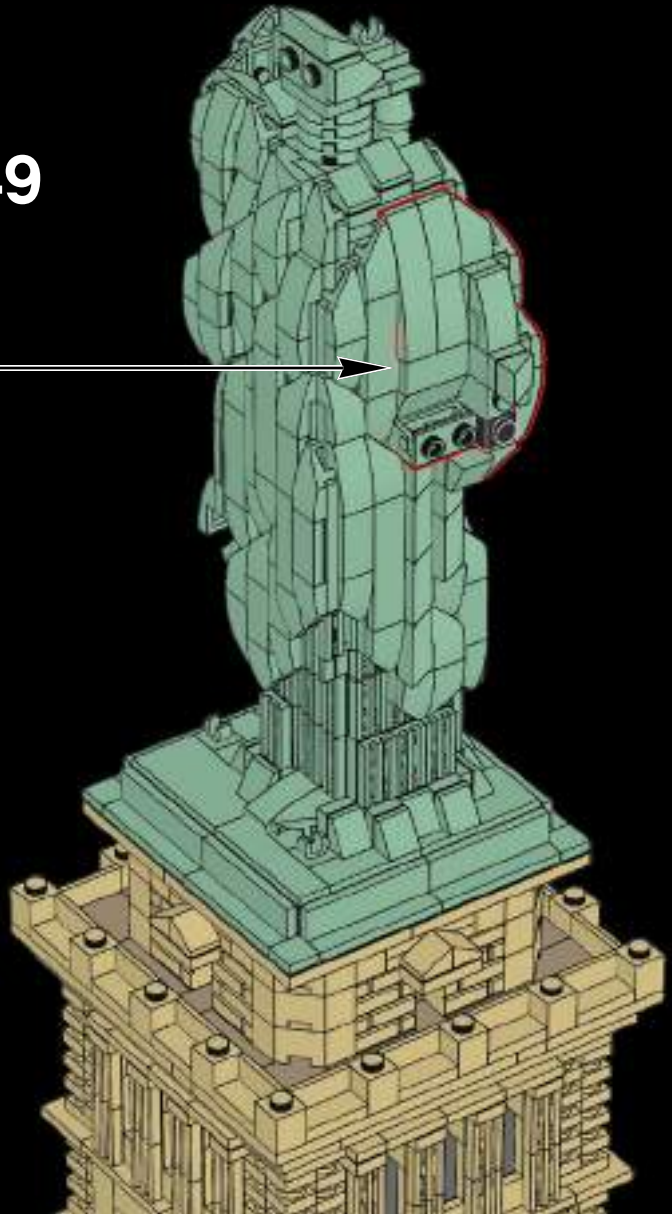



150



151



152



153





154



155

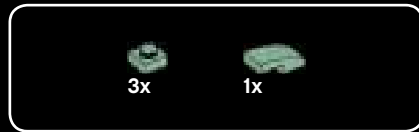

156

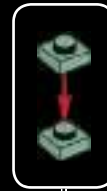



1x



1x

157



1x



1x

158



2x

159

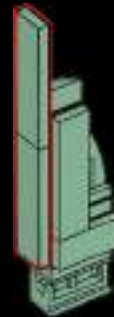

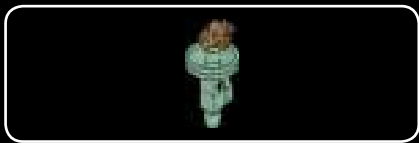

160

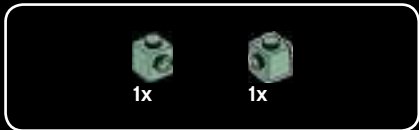
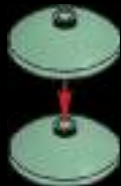

161



162



163



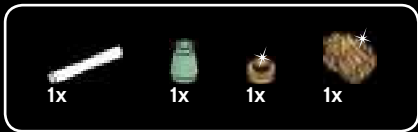

164



165



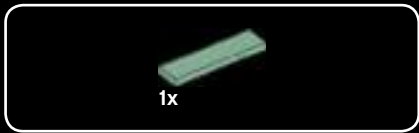

166



167

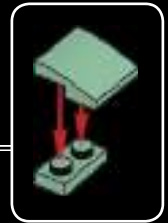
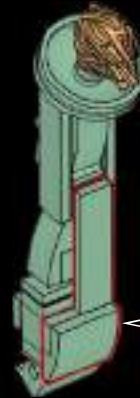
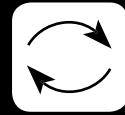

168

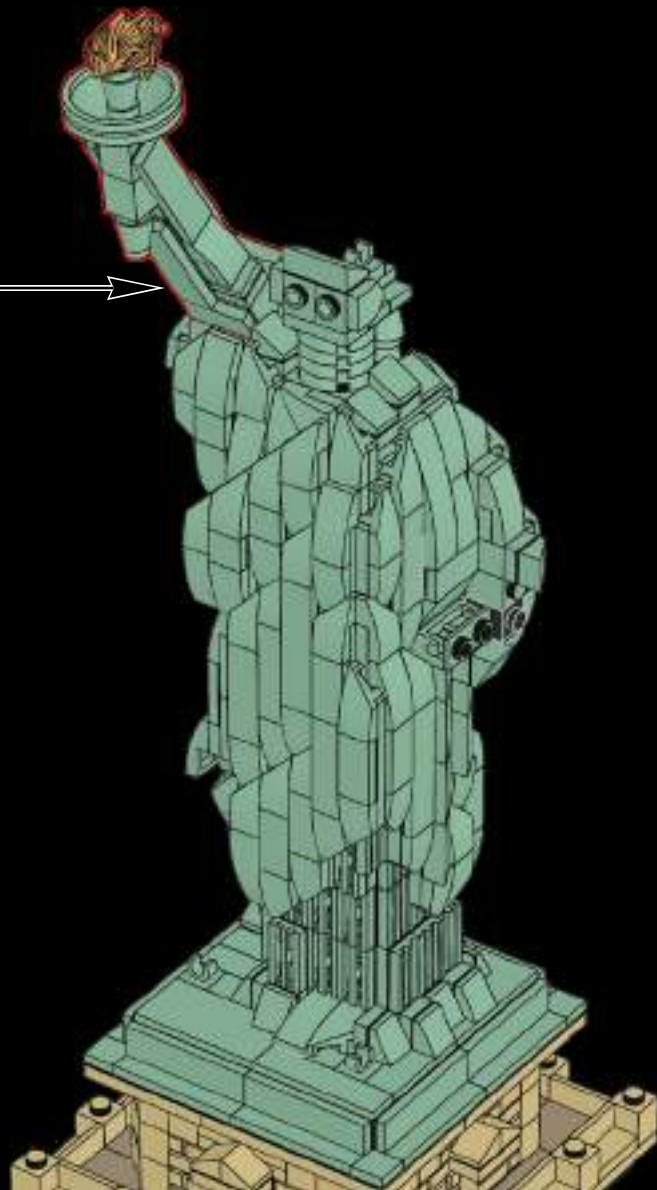

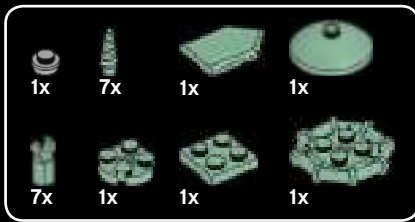

169

1



2



3



4

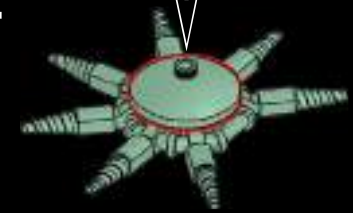

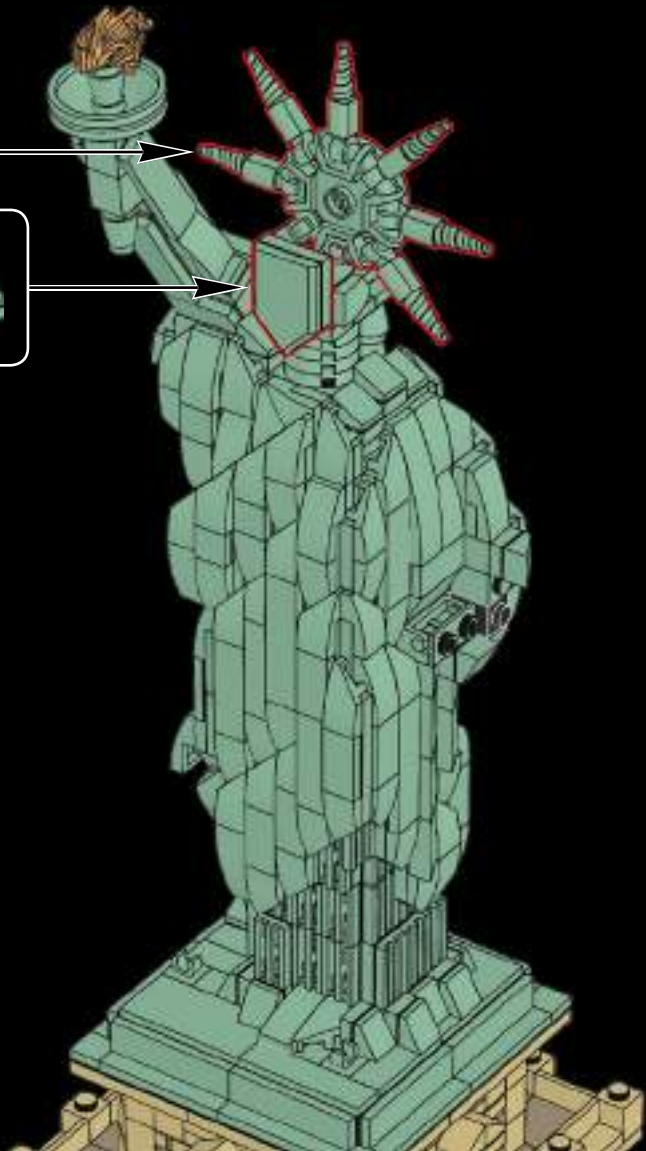
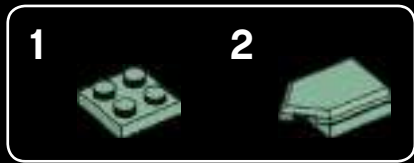

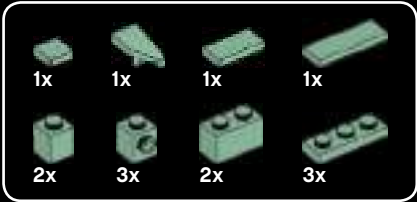

170

1

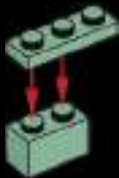

2



3

There are 25 windows
in the crown.
La couronne
possède 25 fenêtres.
Hay 25 ventanas
en la corona.



4



5



6



7

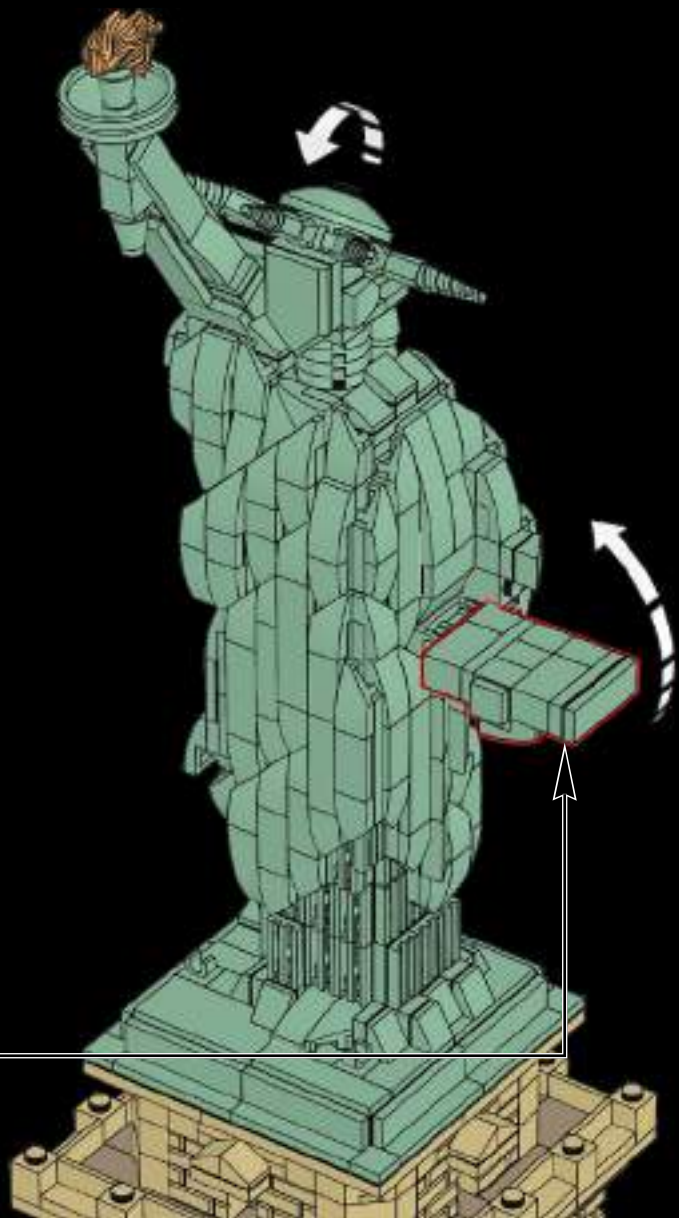
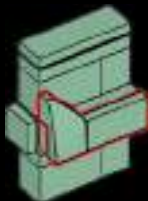



171

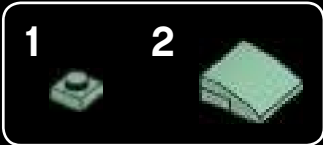
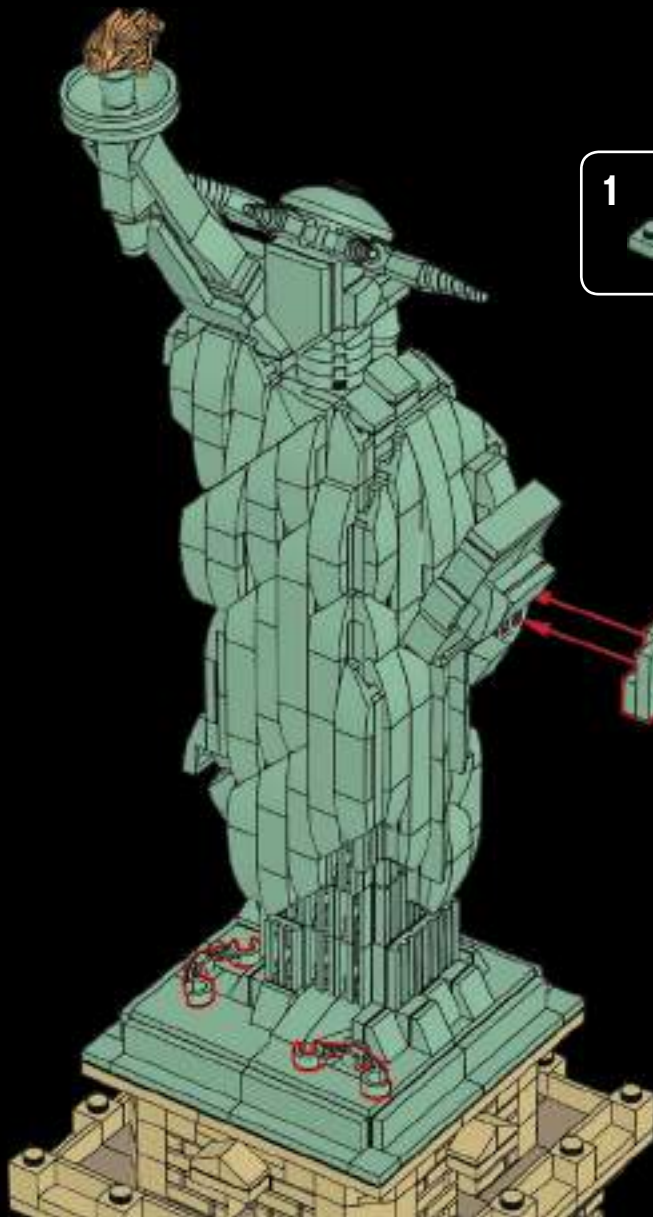

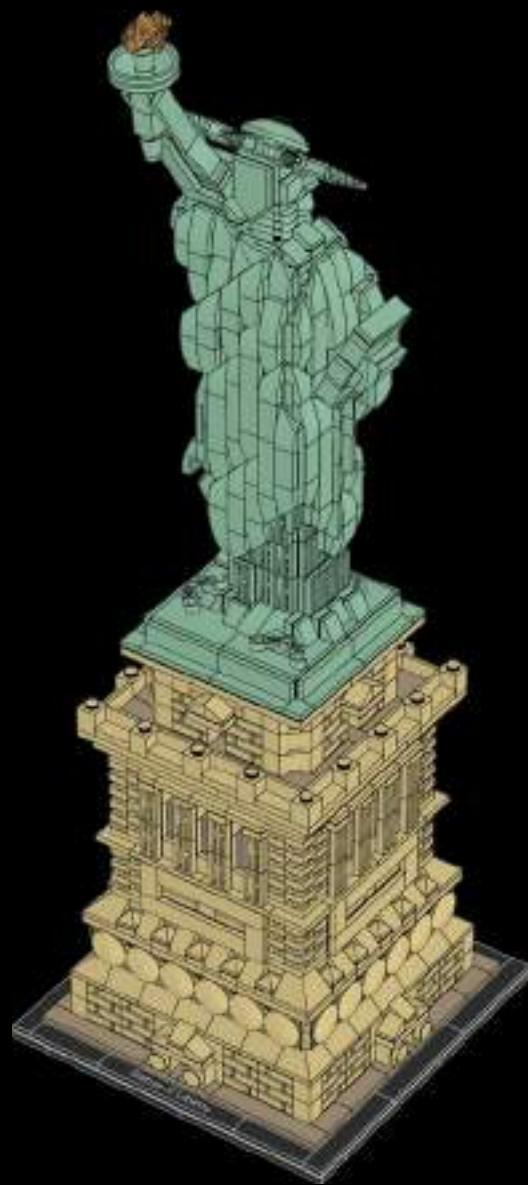

References

Références

Referencias

*Pictures -
Photos :
Fotografías:*

© Shutterstock

© Offset

Customer Service
Kundenservice
Service Consommateurs
Servicio Al Consumidor
[LEGO.com/service](https://www.lego.com/service) or dial

 00800 5346 5555 : 
1-800-422-5346 : 



LEGO® Architecture – do you like it?

The LEGO Group would like your opinion on the new product you have just purchased. Your feedback will help shape the future development of this product series. Please visit:

[LEGO.com/productfeedback](https://www.lego.com/productfeedback)

By completing our short feedback survey, you will be automatically entered into a drawing to win a LEGO® prize.



Aimez-vous LEGO® Architecture ?

Le Groupe LEGO aimerait connaître votre opinion sur le produit que vous venez d'acheter. Vos commentaires nous aideront à concevoir les futurs produits de cette gamme. Veuillez visiter :

[LEGO.com/productfeedback](https://www.lego.com/productfeedback)

En remplissant ce court sondage sur le produit, vous serez automatiquement inscrit à un tirage au sort pour gagner un prix LEGO®.



LEGO® Architecture: ¿te gusta?

The LEGO Group quiere conocer tu opinión acerca del nuevo producto que acabas de comprar. Tus comentarios nos ayudarán a dar forma a los futuros productos de esta serie. Visita:

[LEGO.com/productfeedback](https://www.lego.com/productfeedback)

Al contestar este breve cuestionario de opinión, participarás automáticamente en el sorteo de un producto LEGO®.





Sujeto a términos y condiciones.

LEGO® Architecture

The LEGO® Architecture series creatively captures the essence of many of the world's most iconic landmarks while giving you an enjoyable and engaging LEGO building experience.

Whether your interest is in travel, design, history or architecture, these sets are a physical memento of great trip abroad, a famous building you know well, or a city you still dream of visiting.

Every LEGO Architecture set is designed to be displayed. Much more than just a photo, building and displaying your model on your desk, in the bookcase or on the shelf, lets you be transported every time you admire the view.

Follow us on  

Adam Reed Tucker is the co-developer of the LEGO® Architecture product line.





LEGO® Architecture

La série LEGO® Architecture capture l'essence de nombreux monuments parmi les plus célèbres du monde tout en vous offrant une expérience agréable et stimulante de construction LEGO.

Que votre intérêt porte sur les voyages, le design, l'histoire ou l'architecture, ces ensembles constituent un souvenir tangible d'un voyage mémorable, d'un célèbre bâtiment que vous connaissez bien ou d'une ville que vous rêvez de visiter.

Chaque ensemble LEGO Architecture est conçu pour être exposé. Construire votre modèle et l'exposer sur votre bureau, une bibliothèque ou une tablette vous fera voyager à chaque coup d'œil, bien plus qu'une simple photo ne pourrait le faire.

Suivez-nous sur  



Adam Reed Tucker est le codéveloppeur de la gamme de produits LEGO Architecture.

LEGO® Architecture

La línea LEGO® Architecture captura con creatividad la esencia de muchos de los monumentos más populares del mundo y pone a tu alcance una experiencia de construcción gratificante y cautivadora con el sello característico de LEGO.

Ya sea que te guste viajar o sientas atracción por el diseño, la historia o la arquitectura, estos sets expresan físicamente tus recuerdos de aquel fantástico viaje al extranjero, ese famoso edificio que conoces tan bien o la ciudad que sueñas con visitar algún día.

Todos los sets LEGO Architecture están diseñados para exhibirse. Mucho más que una simple fotografía, construir y exponer un modelo en tu escritorio, un librero o una repisa te traslada a otro lugar al admirar las vistas.

Síguenos en  

Adam Reed Tucker es el codesarrollador de la línea de productos LEGO Architecture.



Celebrate the world of architecture and collect all the models
Célébrez le monde de l'architecture et collectionnez tous les modèles
Celebra el mundo de la arquitectura y colecciona todos los modelos

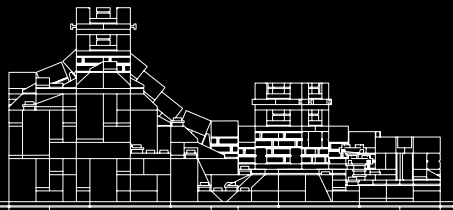

21041
Great Wall of China
La Grande Muraille de Chine
Gran Muralla China



21030
United States Capitol Building
Le Capitole des États-Unis
Edificio del Capitolio de Estados Unidos

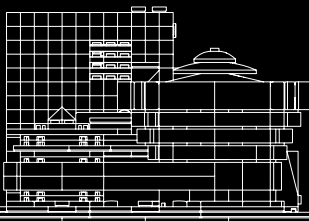

21035
Solomon R. Guggenheim Museum®
Musée Solomon R. Guggenheim®
Museo Solomon R. Guggenheim®



21042
Statue of Liberty
La statue de la Liberté
Estatua de la Libertad

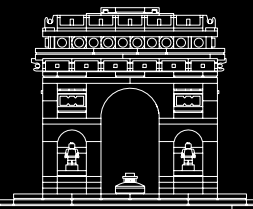

21036
Arc de Triomphe
L'Arc de Triomphe
Arco del Triunfo

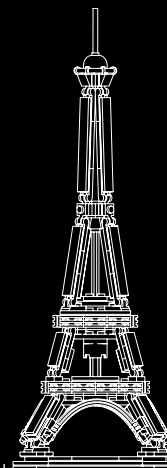

21019
The Eiffel Tower
La tour Eiffel
La Torre Eiffel

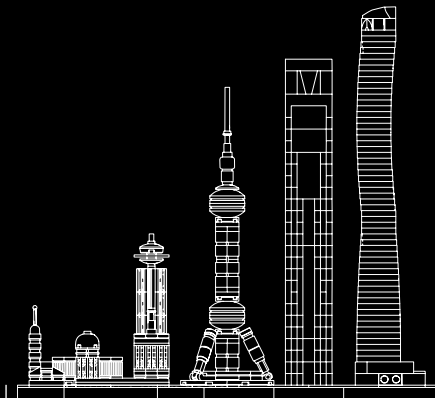

21039
Shanghai
Shanghái

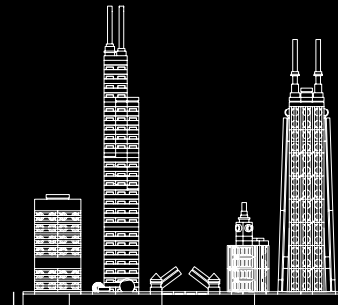

21033
Chicago

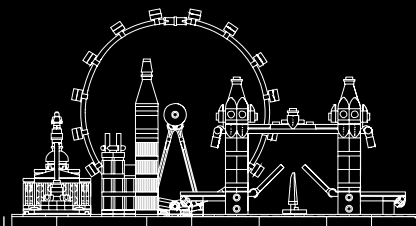

21034
London
Londres

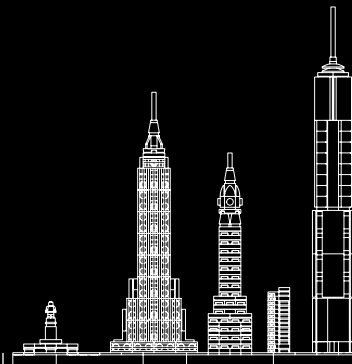

21028
New York City
New York
Nueva York



21032
Sydney
Sídney

8x
4496699

40x
4159553

52x
4113917

12x
4113233

1x
6190252

5x
6187572

56x
614121

8x
6092591

48x
4113915

12x
6148265

4x
4113916

1x
6234261

4x
6157554

6x
4558886

4x
4507045

23x
6175968

32x
4565387

8x
6122047

4x
306224

4x
306926

2x
6135130

12x
6015452

24x
4278422

17x
4114084

8x
4124067

8x
302424

1x
302226

4x
302221

4x
4507047

16x
6069165

20x
4114322

16x
4157277

2x
6206240

7x
242026

4x
300221

96x
4161734

4x
6177314

36x
4114077

4x
4243824

8x
4141630

3x
243126

1x
300121

8x
6139649

48x
6148262

8x
6222431

4x
4114001

2x
242024

8x
663626

4x
300921

8x
4118793

32x
4124456

4x
4162465

12x
4143409

1x
362224

1x
6223269

4x
346021

20x
6177165

4x
6092587

8x
6131896

4x
4509897

1x
362324

8x
303426

3x
6212053

24x
4579260

16x
6146221

36x
4121921

4x
4249019

1x
6240515

8x
4125253

16x
6024495

16x
4118790

20x
4516055

8x
4114026

4x
6175367

7x
6223215

7x
6226411

6x
6134280

40x
6221730

18x
6223913

22x
4652205

25x
6009656

8x
6223225

2x
6125672

3x
6184432

3x
6125669

33x
6099189

3x
4521948

35x
6221729

25x
6210479

5x
6223237

34x
4655080

21x
6223126

6x
4616581

2x
6225000

3x
6223168

17x
4616578

3x
6223234

28x
6196591

6x
6080431

16x
6186823

1x
6186828

3x
6223166

10x
6202626

31x
6069257

1x
6100237

1x
6245273

8x
6184348

1x
6223219

11x
6100234

25x
6192923

4x
6187611



3x
4633693

2x
6194726

6x
6227190

9x
4211525

9x
6123809

1x
4211815

7x
4583862



16x
407023

7x
302323

2x
4558606

2x
4514553

7x
371023

4x
300923

4x
303223

16x
4654577

8x
4211429



6x
4211395



8x
6058177

8x
4113261

1x
6093526

4x
302101

4x
6210105

10x
366601

4x
379501

2x
4211098

12x
4210719

2x
4210700

4x
4211052

4x
4211088



11x
4211063

24x
4211104

8x
4211133

8x
4211053

9x
6039176

1x
4211137

4x
4210706

