

VERITAS®

SCHMETZ INSIDE



Instruction manual



JANIS JOPLIN
1943-1970
AMERICAN SINGER-
SONGWRITER



www.facebook.com/veritassewing



www.instagram.com/veritassewing



www.veritas-sewing.com

Dear Customer,

we congratulate you on your purchase of your sewing machine. You have bought a quality product which has been made with great care and, if serviced right, will serve you well for many years.

Before using it for the first time, we ask you to read the manual at hand carefully, paying special attention to the safety instructions. Persons who are not familiar with this manual must not use the appliance.

We wish you much pleasure and great sewing successes! Questions concerning machine, service and customer care



www.service.veritas-sewing.com

Important safety instructions

When using an electrical appliance, basic safety should always be followed, including the following:

Read all instructions before using this sewing machine.

DANGER - To reduce the risk of electric shock:

1. An appliance should never be left unattended when plugged in.
2. Always unplug this appliance from the electric outlet immediately after using and before cleaning.

WARNING - To reduce the risk of burns, fire, electric shock, or injury to persons:

1. Read the instruction carefully before you use the machine
2. Keep the instructions at a suitable place close to the machine and hand it over if you give the machine to a third party.
3. Use the machine only in dry locations.
4. Never leave the machine unattended with children or elderly people due to they may not be able to estimate the risk.
5. This appliance can be used by children aged from 8 years and above and persons with reduced physical, sensory or mental capabilities or lack of experience and knowledge if they have been given supervision or instruction concerning use of the appliance in a safe way and understand the hazards involved.
6. Children shall not play with the appliance.
7. Cleaning and user maintenance shall not be made by children without supervision.
8. Always switch off the machine if you carry out preparation for work (change the needle, feed the yarn through the machine, change the footer, etc.).
9. Always unplug the machine if you leave it unattended, to avoid injury by expediently switch on the machine.
10. Always unplug the machine if you changing the lamp or carry out maintenance (oiling, cleaning).
11. Don't use the machine if it's wet or in humid environment.
12. Never pull at the cord, always unplug the machine by gripping the plug.
13. If the LED lamp is damaged or broken, it must be replaced by the manufacturer or its service agent or a similarly qualified person, in order to avoid a hazard.

14. Never place anything on the pedal.
15. Never use the machine if the air vents are blocked, keep the air vents of the machine and the foot pedal free from dust, fusel and leftovers.
16. The machine must only be used with designated foot controller, in order to avoid a hazard. If the foot controller is damaged or broken, it must be replaced by the manufacturer or its service agent or a similarly qualified person.
17. The power cord of the foot controller can not be replaced. If the power cord is damaged the foot controller must be disposed
18. The sound pressure level at normal operation is smaller than 75dB(A).
19. Do not dispose of electrical appliances as unsorted municipal waste, use separate collection facilities.
20. Contact your local government for information regarding the collection systems available.
21. If electrical appliances are disposed of in landfills or dumps, hazardous substances can leak into the groundwater and get into the food chain, damaging your health and well-being.
22. When replacing old appliances with new ones, the retailer is legally obligated to take back your old appliance for disposal at least for free of charge.
23. The appliance is not to be used by persons (including children) with reduced physical, sensory or mental capabilities, or lack of experience and knowledge, unless they have been given supervision or instruction. (For outside Europe)
24. Children being supervised not to play with the appliance. (For outside Europe)

SAVE THESE INSTRUCTIONS

This sewing machine is intended for household use only.

Be sure to use the sewing machine in the temperature range from 5°C to 40°C. If the temperature is excessively low, the machine can fail to operate normally.

Contents

Principal parts of the machine	7
Accessories	8
Connecting the machine	9
Sewing table	10
Free arm	19
Winding the bobbin	11-13
Inserting the bobbin	14-15
Threading the upper thread	16-18
Raising the bobbin thread	19
Replacing the needle	20
Matching needle/ fabric/ thread	21
Changing the presser foot	22
Two-step presser foot lifter	23
Thread tension	24-25
How to choose your pattern	25
Useful skills	26-28
Starting to sew	26
Sewing corners	26
Sewing curves	26
Reverse	27
Cutting the thread	27
Sewing thin fabrics	28
Sewing stretch fabrics	28
Straight stitches	28
3-step zigzag	29
Overcasting stitches	30
Using the all purpose foot	30
Blind Hem	31
Buttonhole stitch	32-33
Making a buttonhole on stretch fabrics	33
Button sewing	34

Contents

Zipper insertion.....	35-37
Inserting a centered zipper.....	35
Inserting a side zipper	36
Gathering.....	38
Free motion darning, embroidery and monogramming	38-40
Darning	38
Preparation for embroidering and monogramming	39
Monogramming.....	40
Applique	41
Scallop stitching	42
Shell tuck stitching	42
Scallop stitching	42
Maintenance	43
Trouble shooting guide	44-46
Disposal.....	47

Principal parts of the machine

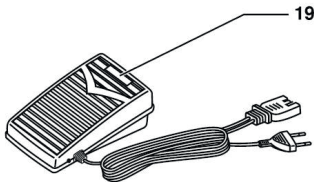
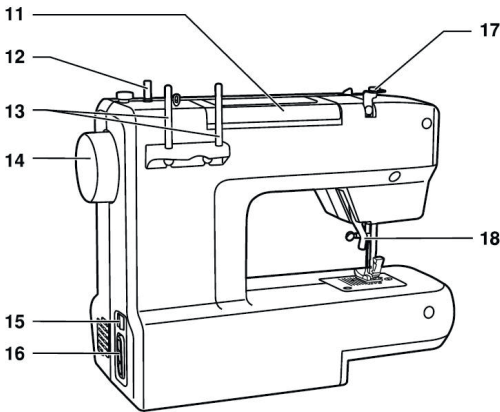
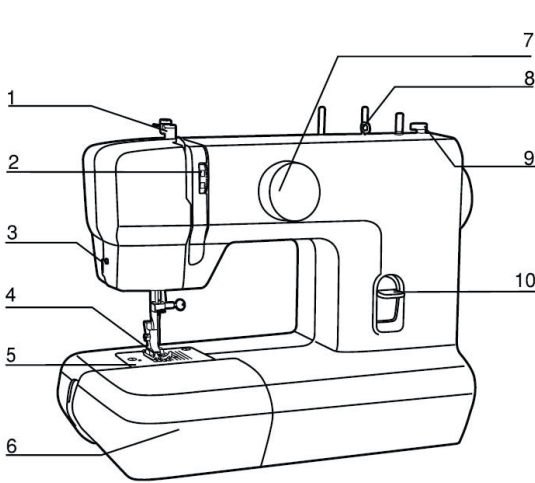

1. Thread take-up lever
2. Tension dial
3. Thread cutter
4. Presser foot
5. Needle plate
6. Sewing table and accessory box
7. Pattern selector dial
8. Bobbin winder spindle
9. Bobbin winder stopper
10. Reverse sewing lever
11. Handle
12. Spool spindle
13. Spool pin
14. Handwheel
15. Power switch
16. Main plug socket
17. Thread guide
18. Presser foot lifter
19. Foot control

Accessories

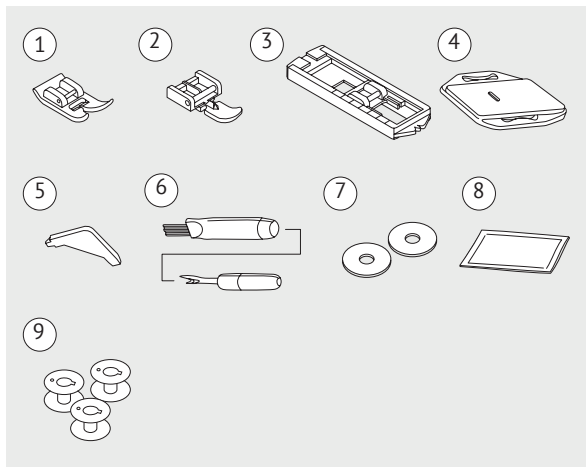

Standard

1. All purpose foot
2. Zipper foot
3. Buttonhole foot
4. Darning plate
5. L-screwdriver
6. Seam ripper/ brush
7. Spool pin felt (2x)
8. Pack of needles
9. Bobbin (3x)

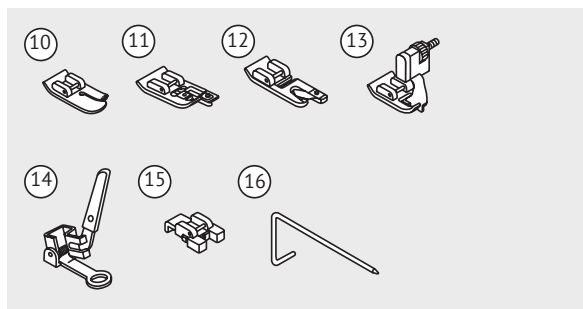

Optional

10. Quilting foot
11. Overcasting foot
12. Hemmer foot
13. Blind hem foot
14. Darning/ embroidery foot
15. Button sewing foot
16. Edge/ quilting guide

Please Note:

- Accessories are stored inside the accessory box.
 - * Optional accessories are not supplied with this machine; they are however available as special accessories from your local dealer.
-

Connecting machine to power source

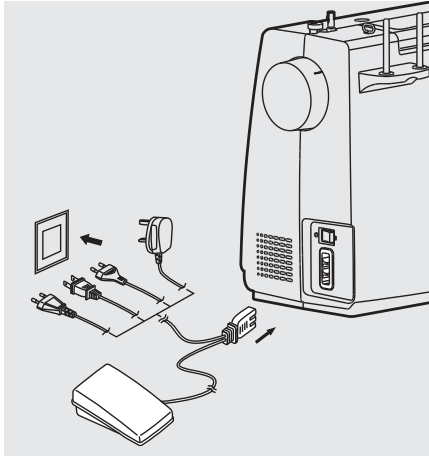

⚠ Attention:

Always make sure that the machine is unplugged from power source and the main switch is on ("O") when the machine is not in use and before inserting or removing parts.

Before connecting the power supply, make sure that the voltage and the frequency shown on the rating plate conform to your mains power. Place the machine on a stable table.

1. Connect the machine to a power source as illustrated.
2. Turn on the power switch.
3. The sewing lamp will light up when the switch is turned on.

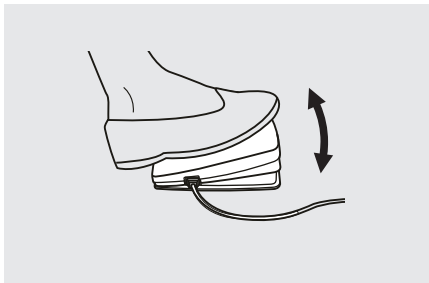

Foot Control

With the sewing machine turned off, insert the foot control plug into its connector on the sewing machine.

Turn on the sewing machine, and then slowly depress the foot control to start sewing. Release the foot control to stop the sewing machine.

➔ Note:

Consult a qualified electrician if in doubt as to connect the machine to the power source.

Sewing table

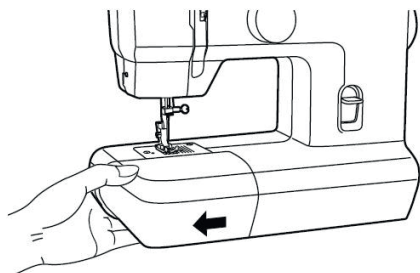

Hold the sewing table horizontally, then pull toward the left to remove it from the machine.

Attach the sewing table, and then push it to the right.

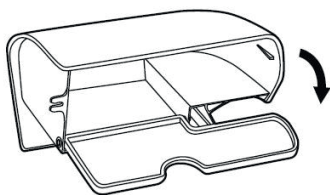

The inside of the snap-in sewing table is used as an accessory box.

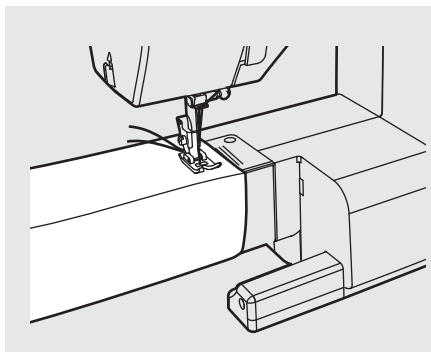

Free arm

Free-arm sewing is convenient for sewing tubular areas such as pant hems and cuffs.

Winding the bobbin

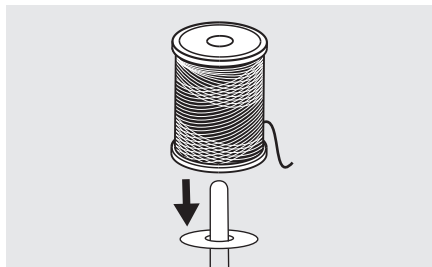
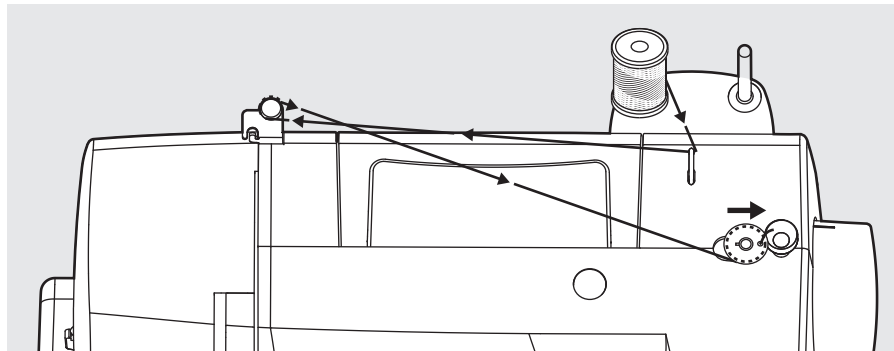

1. Place the thread and spool holder onto the spool pin.

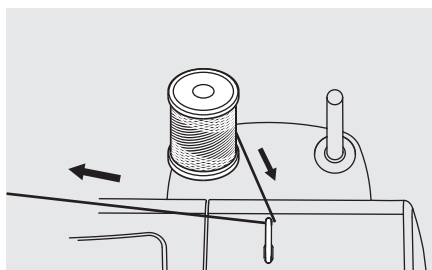

2. Draw the thread from the spool through the upper thread guide.

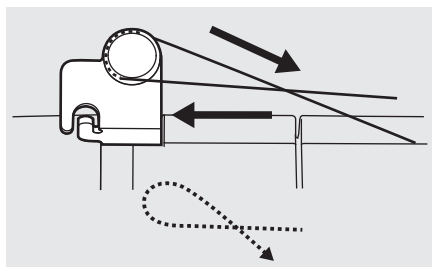

3. Wind the thread clockwise around the bobbin winder tension discs.

Winding the bobbin

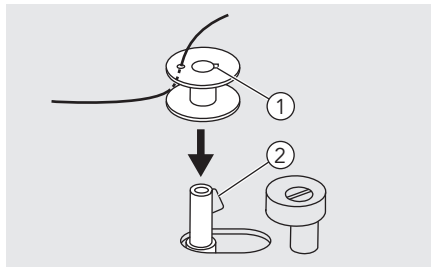

4. Place the thread end through one of the inner holes as illustrated and place the empty bobbin on the spindle.

- ① Notch
- ② Bobbin winder shaft spring

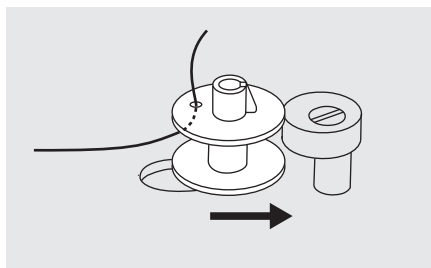

5. Push the bobbin to the right.

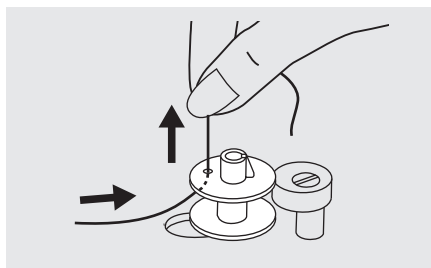

6. Hold the thread tail securely in one hand.

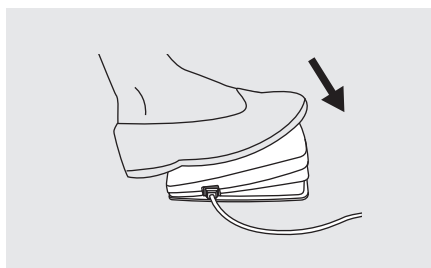

7. Press on the foot control to start winding the bobbin.

Winding the bobbin

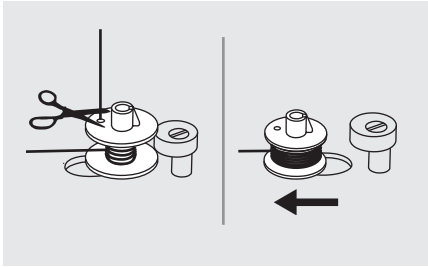

8. After the bobbin has wound a few turns stop the machine and cut the thread near the hole of the bobbin. Continue filling the bobbin until it is full. Once the spool is full, it rotates slowly. Release the pedal or stop the machine. Push the bobbin winder spindle to the left.

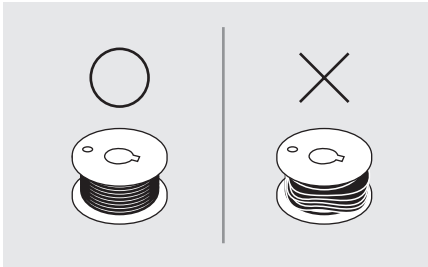

Note:

Use a bobbin that has been correctly wound with thread, otherwise the needle may break or the thread tension will be incorrect.

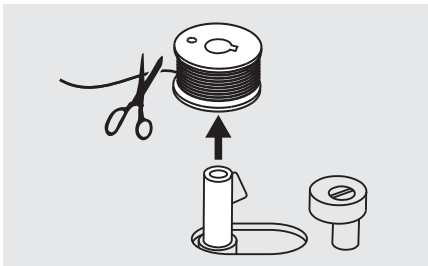

9. Cut the thread and then remove the bobbin.

Note:

When the bobbin winder spindle is placed on the right, "bobbin winding position", the machine will not sew and the handwheel will not turn. To start sewing, push the bobbin winder spindle to the left "sewing position".

Inserting the bobbin

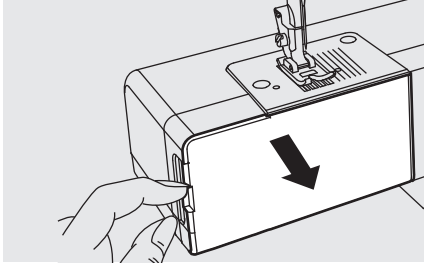

⚠ Attention:

Turn the power switch to off ("O") before inserting or removing the bobbin.

When inserting or removing the bobbin, the needle must be fully raised.

Remove the sewing table, then open the hinged cover.

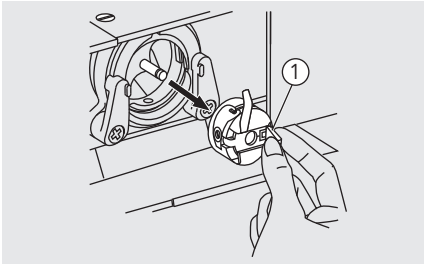

Pull the bobbin case by the hinged latch.

① Hinged latch

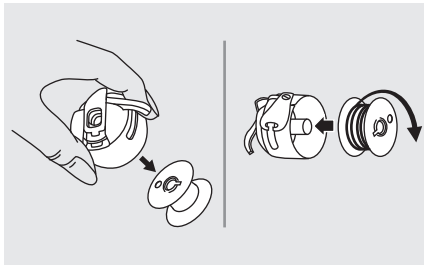

Remove the bobbin from the bobbin case.

Hold the bobbin case with one hand. Insert the bobbin so that the thread runs in a clockwise direction (arrow).

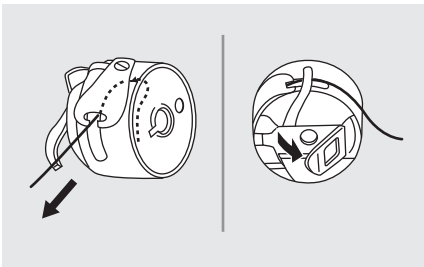

Pull the thread through the slit and under the finger.

Leave a 6 inch tail of thread.

Make sure the bobbin case finger fits into the notch at the top of the race as illustrated.

Inserting the bobbin

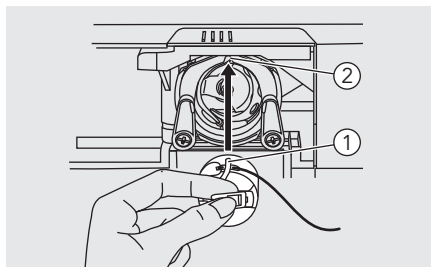

- ① Bobbin case finger
- ② Notch

Hold the bobbin case by the hinged latch.

➔ Note:

If the bobbin case is not properly placed back into the machine, it will fall out off the shuttle immediately after starting to sew.

Threading the upper thread

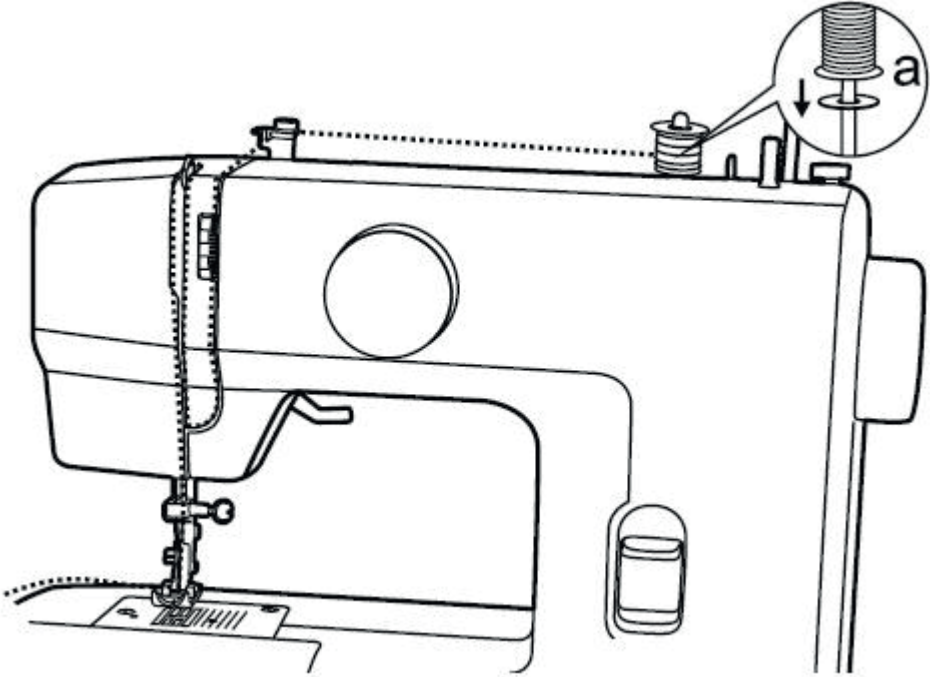

➔ Please Note:

It is important to carry out the threading correctly otherwise sewing problems may result.

1. Raise the needle to its highest position by turning the handwheel towards you (counterclockwise) . Raise the presser foot to release the tension discs.

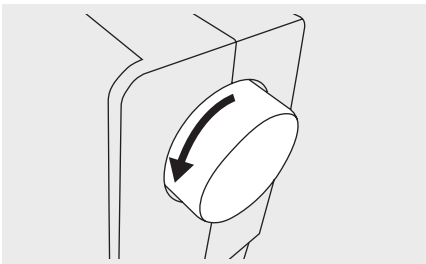

Threading the upper thread

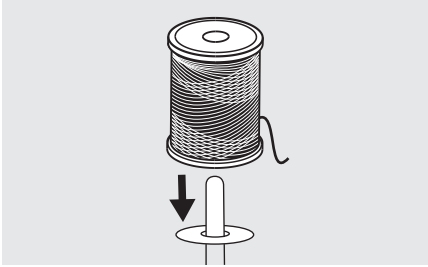

2. Place the thread and spool holder onto the spool pin.

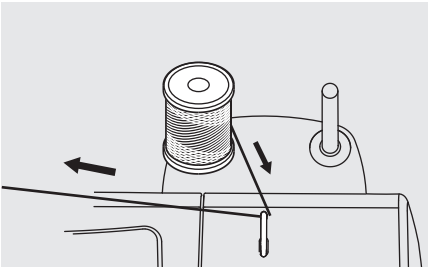

3. Draw the thread from the spool through the upper thread guide.

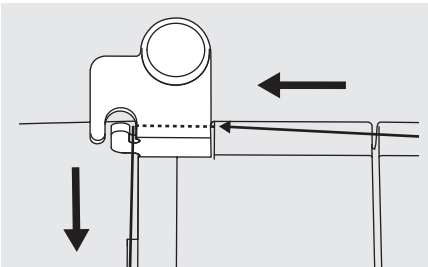

4. Guide the thread around the thread guide as illustrated.

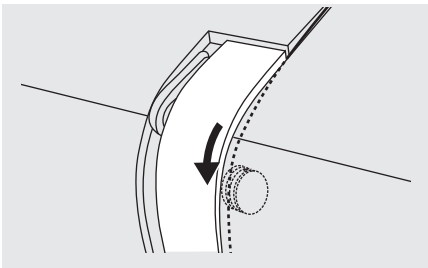

5. Thread the tension module by passing the thread between the silver discs.

Threading the upper thread

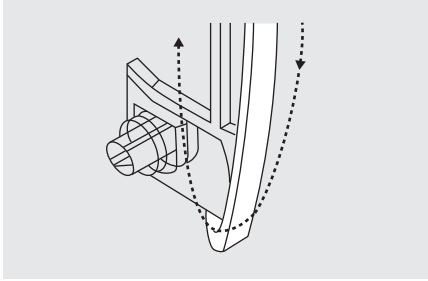

6. Then, down and around the check spring holder.

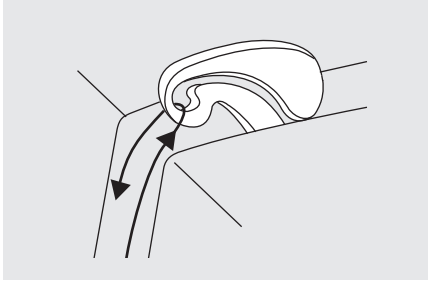

7. At the top of this movement pass the thread from right to left through the slotted eye of the take-up lever and then downwards again.

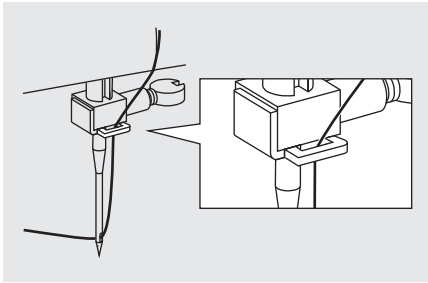

8. Now pass the thread behind the thin wire needle clamp guide. Pull the end of the thread through the needle from front to rear and pull out about 10 cm of thread. Use the needle threader to thread the needle.

Raising the bobbin thread

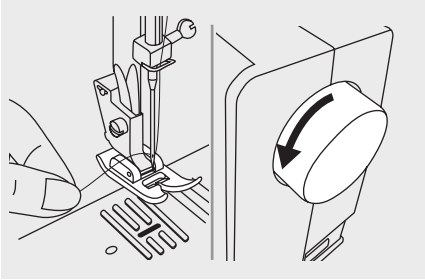

Hold the upper thread with the left hand. Turn the handwheel towards you (counterclockwise) lowering it, then raise the needle.

➔ Note:

If it is difficult to raise the bobbin thread, make sure the thread is not trapped by the hinged cover or the sewing table.

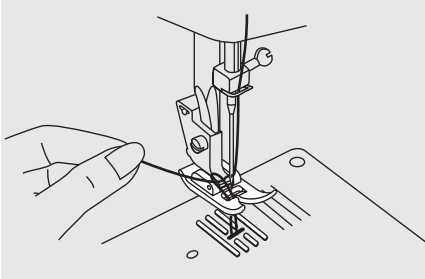

Gently pull on the upper thread to bring the bobbin thread up through the needle plate hole.

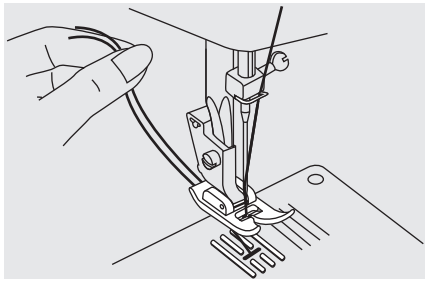

Lay both threads to the back under the presser foot.

Replacing the needle

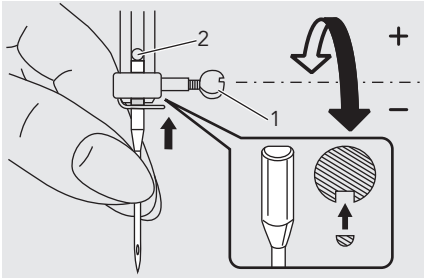

⚠ Attention:

Turn the power switch to off ("O") when carrying out any of the above operations!

Change the needle regularly, especially when it shows signs of wear or causes problems.

Insert the needle following the illustrated instructions.

1. Turn the handwheel towards you (counterclockwise) lowering, then raising the needle. Turn the needle clamp screw counterclockwise to remove the needle. The flat side of the shaft should be positioned towards the back.
2. Insert the needle as far up as it goes. Next, tighten the needle clamp.



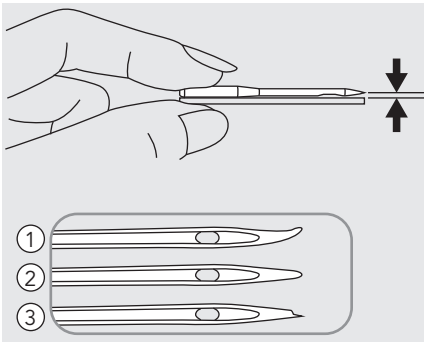

Needles must be in perfect condition.



Problems can occur with:

- ① Bent needles
- ② Blunt needles
- ③ Damaged points

Matching needle/ fabric/ thread

NEEDLE SIZE	FABRICS	THREAD
9-11 (65-75) 	Lightweight fabrics-thin cottons, voile, serge, silk, muslin, Qiana, interlocks, cotton knits, tricot, jerseys, crepes, woven polyester, shirt & blouse fabrics.	Light-duty thread in cotton, nylon, polyester or cotton wrapped polyester.
11-14 (80-90) 	Medium weight fabrics-cotton, satin, kettlecloth, sailcloth, double knits, lightweight woollens.	Most threads sold are medium size and suitable for these fabrics and needle sizes. Use polyester threads on synthetic materials and cotton on natural woven fabrics for best results. Always use the same thread on top and bottom.
14 (90) 	Medium weight fabrics-cotton duck, woolen, heavier knits, terrycloth, denim.	
16 (100) 	Heavyweight fabrics-canvas, woolens, outdoor tent and quilted fabrics, denim, upholstery material (light to medium).	

Please Note:

- In general, fine threads and needles are used for sewing fine fabrics, thicker threads and needles are used for sewing heavy fabrics.
- Always test thread and needle size on a small piece of fabric which will be used for actual sewing.
- Use the same thread for needle and bobbin.
- Use a stabilizer or place a backing for fine or stretchy fabrics, and select the correct presser foot.
- It is recommended that a 90/14 needle should be used when embroidering on heavyweight fabrics or stabilizing products (for example, denim, puffy foam, etc.). A 75/11 needle may bend or break, which could result in injury.
- For transparent nylon thread, always use needle 90/14 - 100/16. The same thread is usually used for the bobbin thread and upper threading.

Changing the presser foot

Attention:

Turn the power switch to off ("O") when carrying out any of the below operations!

Removing the presser foot

Raise the presser foot.

Push the presser foot to disengage it from the cut-out.

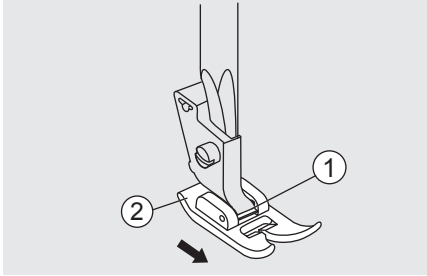

- ① Cut-out
- ② presser foot

Attaching the presser foot

Install the pin of the presser foot into the cut-out of the presser foot holder.

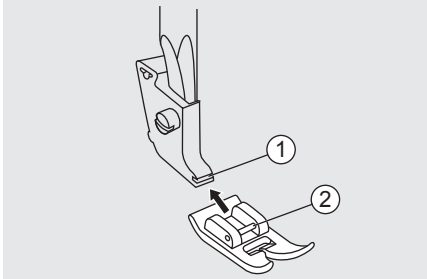

- ① Cut-out
- ② Pin

Removing and attaching the presser foot holder

Raise the presser foot bar. Align the presser foot holder with the lower left side of the presser bar. Hold the presser foot holder, then tighten the screw using the screwdriver.

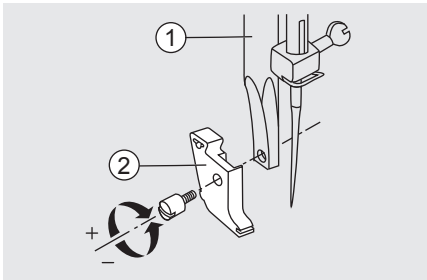

- ① Presser foot bar
- ② Presser foot holder

Two-step presser foot lifter

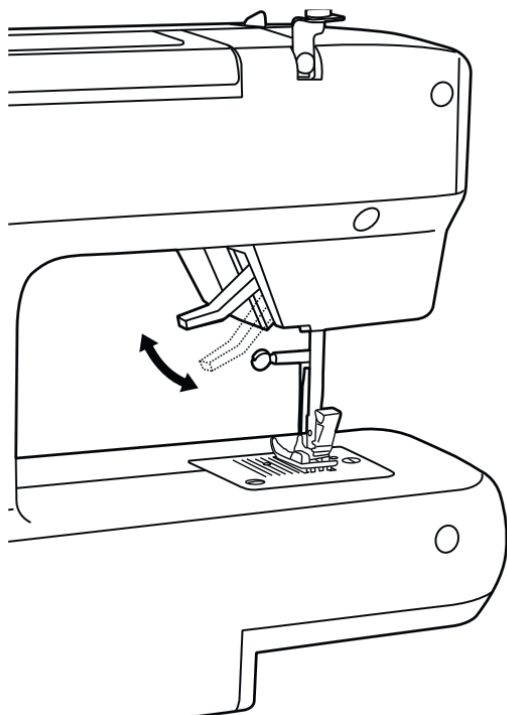

1. The presser foot lifter raises and lowers your presser foot.
2. When sewing several layers or thick fabrics, the presser foot can be raised a second stage for easy positioning of the work.

➔ Please Note:

The needle must always be at the highest position.

Thread tension

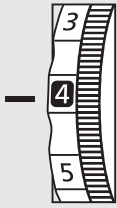

- Basic thread tension setting: "4"
- To increase the tension, turn the dial up to the next number. To reduce the tension, turn the dial down to the next number.
- Proper setting of tension is important for good sewing.
- For all decorative sewing you will always obtain a nicer stitch and less fabric puckering when the upper thread appears on the bottom side of your fabric.
- There is no single tension setting appropriate for all the stitch functions and fabrics.

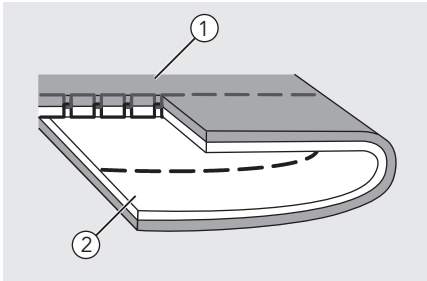

Normal thread tension for straight stitch sewing.

- ① Surface
- ② Reverse side
- ③ Upper thread
- ④ Bobbin thread

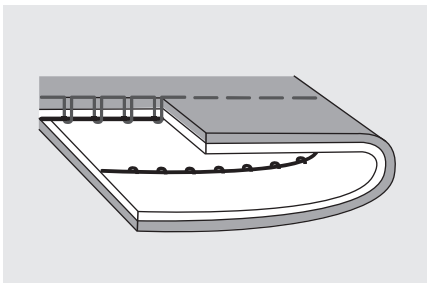
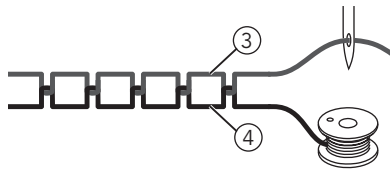

Thread tension is too loose for straight stitch sewing. Turn the dial to the higher number.



Thread tension

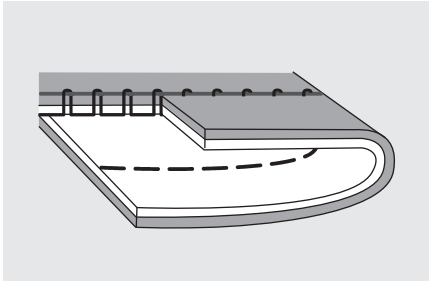

Thread tension is too tight for straight stitch sewing. Turn the dial to the lower number.

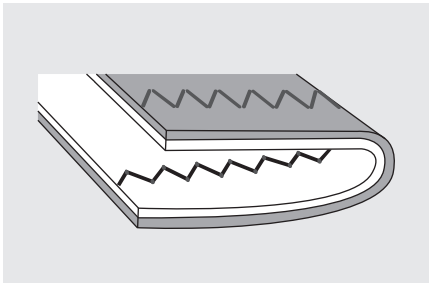

Normal thread tension for zig zag and decorative sewing.

Correct thread tension is when a small number of the upper thread appears on the bottom side of fabric.



How to choose your pattern

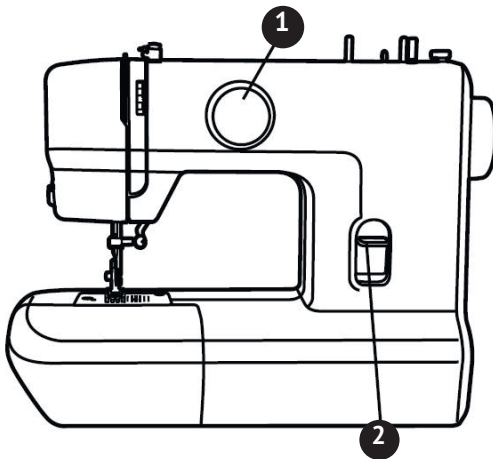

To select a stitch, simply turn the pattern selector dial. The pattern selector dial may be turned in either directions.

For straight stitch, select pattern "|||||" with the pattern selector dial.

For zigzag stitch, select pattern "~~~~~" with the pattern selector dial.

- ① Reverse lever
- ② Pattern selector dial

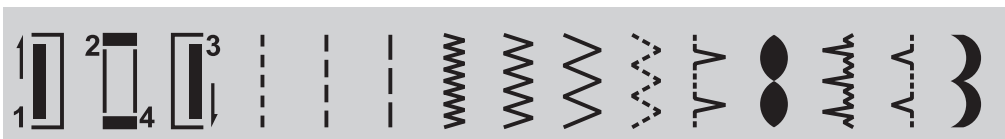

Useful skills

Various ways to achieve better results for your sewing projects are described below. Refer to these tips when sewing your project.

A trial piece of fabric should be sewn because, depending on the type of fabric and stitching being sewn, the desired results may not be achieved.

For the trial sewing, use a piece of fabric and thread that are the same as those used for your project and check the thread tension.

Since the results differ depending on the type of stitching and the number of layers of fabric sewn, perform the trial sewing under the same conditions that will be used with your project.

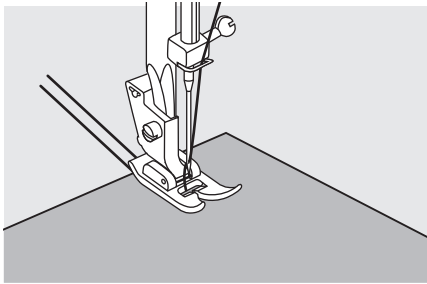

Starting to sew

Raise the presser foot and place the fabric under the foot.

Lower the needle into the fabric.

Lower the presser foot and smooth the threads toward the back. Depress the foot control.

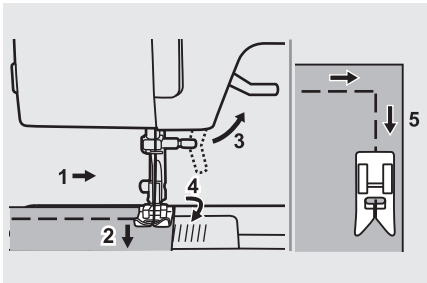

Sewing corners

1. Stop the sewing machine when you reach a corner.
2. Lower the needle into the fabric.
3. Raise the presser foot.
4. Use the needle as a pivot and turn the fabric.
5. Lower the presser foot and resume sewing.

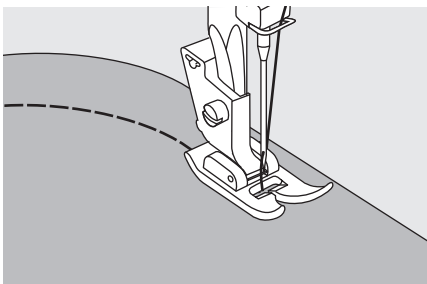

Sewing curves

Slightly change the sewing direction to sew around the curve.

Useful skills

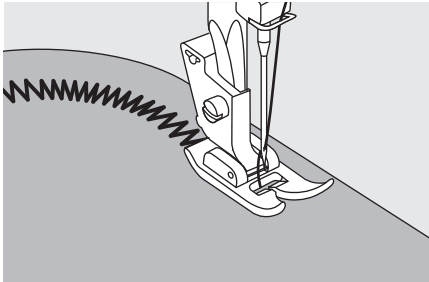

When sewing along a curve while using a zigzag stitch, select a shorter stitch length in order to obtain a finer stitch.

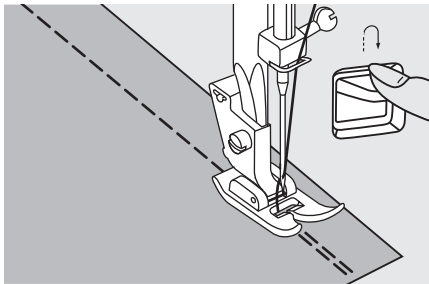

Reverse

Reverse stitching is used to secure the threads at the beginning and at the end of a seam.

Press the reverse sewing lever and sew 4-5 stitches.

The machine will sew forward when the button is released.

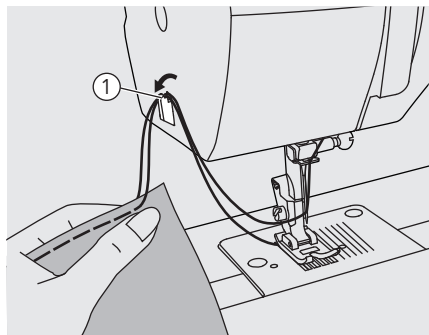

Cutting the thread

Bring the thread take up lever to its highest position, raise the presser foot and remove the fabric.

Guide both threads to the side of the face plate and into the thread cutter. Pull the threads down to cut them.

① Thread cutter

Useful skills

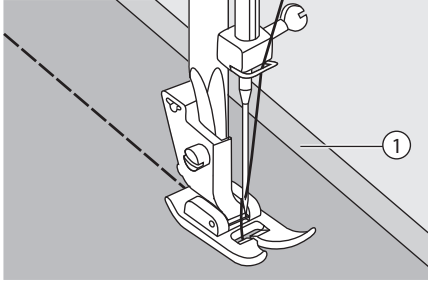

Sewing thin fabrics

When sewing thin fabrics, the stitching may become misaligned or the fabric may not feed correctly. If this occurs, place thin paper or stabilizer material under the fabric and sew it together with the fabric. When you have finished sewing, tear off any excess paper.

- ① Stabilizer material or paper

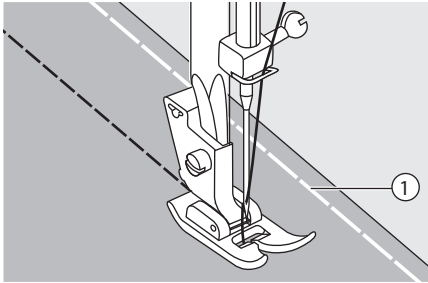

Sewing stretch fabrics

Baste the pieces of fabric together, and then sew without stretching the fabric.

- ① Basting

Straight stitches

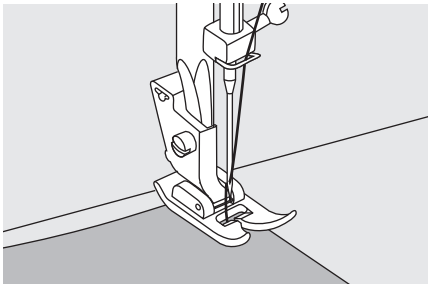

To begin sewing, set the machine for straight stitch.

Place the fabric under the presser foot with the fabric edge lined up with the desired seam guide line on the needle plate.

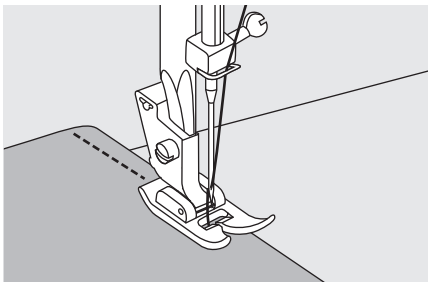

Lower the presser foot lifter and then press the foot control to start sewing.



3-step zigzag



Sewing on lace and elastic, darning, mending, reinforcing edges.

Set the machine as illustrated.

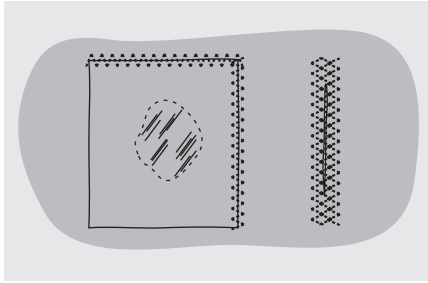

Place the patch in position. The stitch length can be shortened to produce very close stitches.

When mending tears, it is advisable to use a piece of backing fabric as reinforcement. The stitch density can be varied by adjusting the stitch length. First sew over the center and then overlap on both sides. Depending on the type of fabric and damage, sew between 3 and 5 rows.

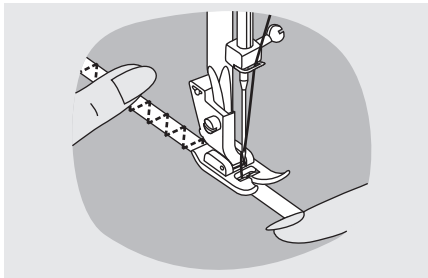

Sewing elastic

Place the elastic on the fabric.

As you sew, stretch the elastic both ahead and behind the presser foot as illustrated.

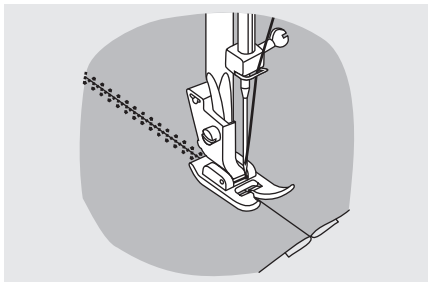

Joining fabric

The elastic stitch can be used to join two pieces of fabric together and it is very effective when sewing knitted fabrics. If nylon thread is used, the stitch will not be visible.

Place the edges of the two pieces of fabric together and center them under the presser foot.

Sew them together using the elastic stitch, taking care to keep the two fabric edges close together as illustrated.

Overcasting stitches

Sewing overcasting stitches along the edge of fabric prevent it from fraying.



Using the all purpose foot

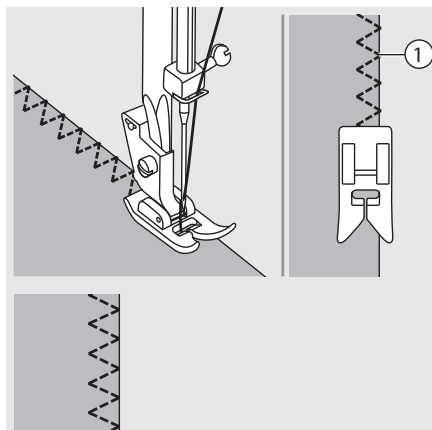

Change the presser foot to the all purpose foot.

Sewing the overcasting along the edge of the fabric so that the needle drops over the edge of the fabric on the right side.

① Needle drop point

Blind Hem

Secure the bottom of skirts and pants with a blind hem, this stitch will sew without stitches showed on the right side of the fabric.

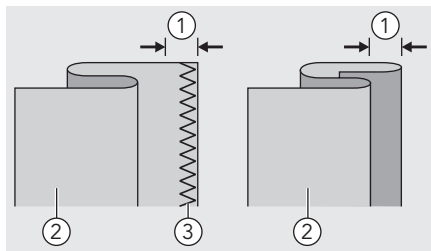

⋈⋈⋈ Blind hem for stretch fabrics.

⋈⋈⋈ Blind hem for firm fabrics.

Fold the fabric as illustrated with the reverse side up.

First carry out an overcasting stitch as shown in left picture.

➡ Please Note:

It takes practice to sew blind hem. Always make a sewing test first.

- ① 5mm
- ② Reverse side
- ③ Overcasting stitch

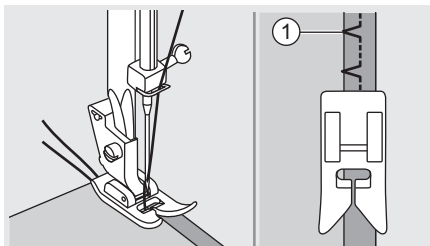

Place the fabric under the foot. Turn the handwheel forwards until the needle swings fully to the left. It should just pierce the fold of the fabric.

- ① Needle drop point

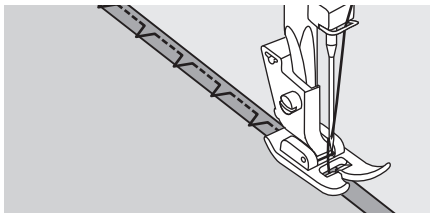

Sew slowly, guiding the fabric carefully along the edge of the guide.

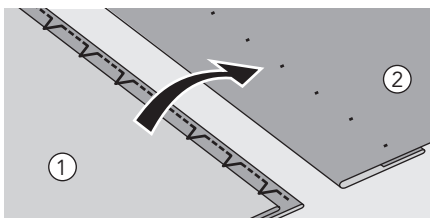

Turn over the fabric.

- ① Reverse side
- ② Right side

Buttonhole stitch

Buttonholes can be adapted to the size of the button.

For stretch fabric or thin fabric, it is recommended to use a stabilizer for a better buttonhole finish.

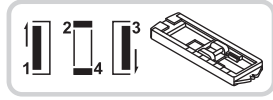

Please Note:

Before sewing a buttonhole on your project, practice on a scrap piece of the same type of fabric.

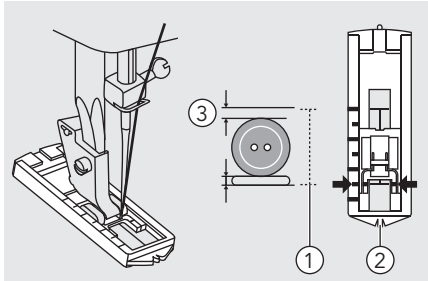

- Measure the diameter and thickness of the button and add 3mm (1/8 inch) for bartacks in order to obtain the correct buttonhole length; mark the buttonhole size on the fabric.
- Place the fabric under the foot, so that the marking on the buttonhole foot aligns with starting marking on fabric. Lower the foot so that the buttonhole center line marked on the fabric aligns with the center of the buttonhole foot.

- ① Buttonhole size
- ② Buttonhole foot center
- ③ 3mm (1/8 inch)

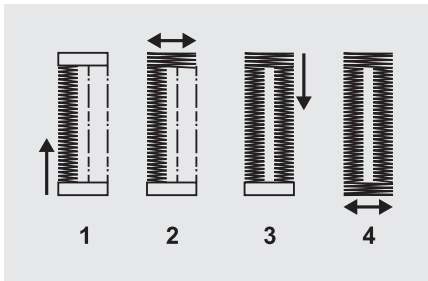

Follow the 4-step sequence changing from one step to another with the pattern selector dial. When moving step by step through the buttonhole process, be sure that the needle is raised before turning the pattern selector dial to the next step. Take care not to sew too many stitches in steps 2 and 4. Use the seam ripper and cut the buttonhole open from both ends towards the middle.

Tips :

- Slightly reduce the upper thread tension to produce better results.
- Use a backing for fine or stretchy fabrics.
- It is advisable to use heavy thread or cord for stretch or knit fabrics.

Buttonhole stitch

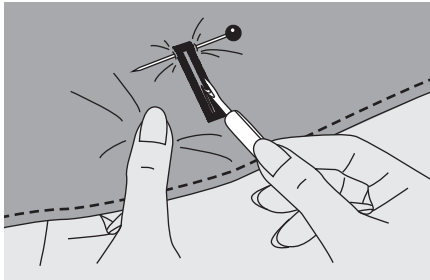

Cut the center of the buttonhole being careful not to cut any stitches on either side. Use a pin on the buttonhole so you do not cut too many stitches.

Please Note:

When cutting the buttonhole with the seam ripper, do not place your hands in the cutting direction, otherwise injuries may result.

Making a buttonhole on stretch fabrics

When sewing buttonholes on stretch fabric, hook heavy thread or cord under the buttonhole foot.

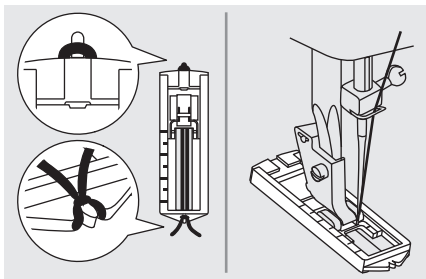

Attach the buttonhole foot and hook the gimp thread onto the back of the presser foot.

Bring the two gimp thread ends to the front of the foot and insert them into the grooves, then tie them there temporarily. Lower the presser foot and start sewing.

The zig-zag should sew over the heavy thread or cord.

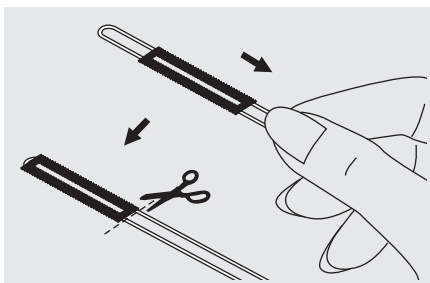

Once sewing is completed, pull the gimp thread gently to remove any slack, then trim off any excess.

Please Note:

It is suggested that you use interfacing on the backside of the fabric.

Button sewing

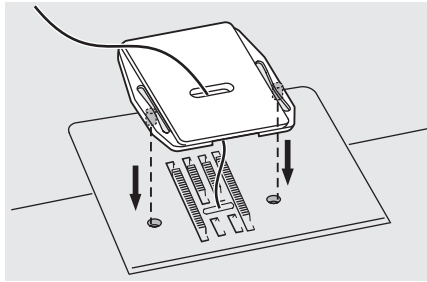
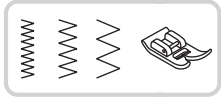

Install the darning plate.

Position the work under the foot. Align two holes of the button with the slot of the presser foot and lower the foot to hold the button securely.

Turn the handwheel to check that the needle goes cleanly into the left and right hole of the button.

Make sure that the needle does not hit the button during sewing, otherwise the needle may break.

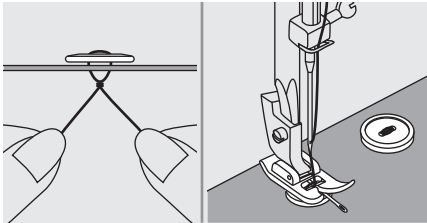

Sew approximately 10 stitches at slow speed.

Raise the foot and cut the remaining threads about 10 cm from the fabric.

Pull the end of the upper thread to the back of the fabric, then tie it with the bobbin thread.

If a shank is required (ex. sew on coats or jackets), place a darning needle on top of the button and sew.

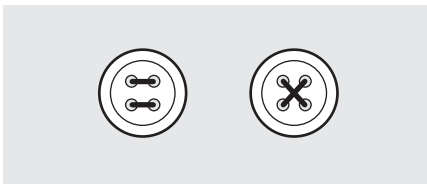

For buttons with 4 holes, sew through the front two holes first, push the work forward and then sew through the back two holes.

Remove the darning plate.

Zipper insertion

This foot can be set to sew on each side of the zipper, the edge of the foot guides the zipper to ensure straight placement.

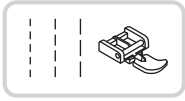

⚠ Attention:

Zipper foot should be used for sewing straight stitches only. It is possible that the needle could hit the presser foot and break when sewing other patterns.

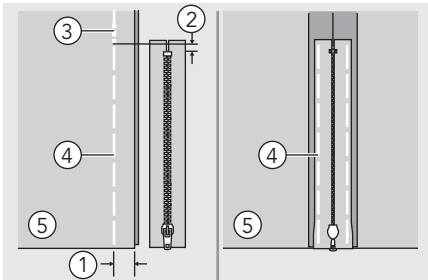

Inserting a centered zipper

- Place the right sides of the fabric together. Sew a bottom seam 2cm from the right edge of the zipper bottom stop position. Sew a few stitches in reverse to lock. Increase the stitch length to maximum, set the tension below 2 and baste the remaining length of the fabric.
- Press open the seam allowance. Place the zipper face down on the seam allowance with the teeth against the seam line. Baste the zipper tape.

- ① 2cm
- ② 5mm
- ③ Reverse stitches
- ④ Basting stitching
- ⑤ Reverse side

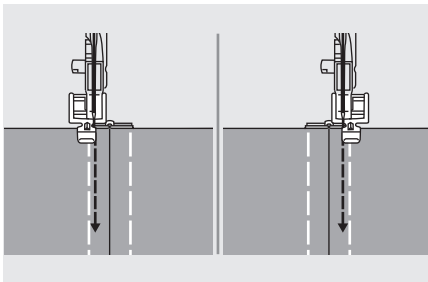

- Attach the zipper foot. Attach the right side of the presser foot pin to the holder when sewing the left side of the zipper.
- Attach the left side of the presser foot pin to the presser foot holder when sewing the right side of the zipper.

Zipper insertion

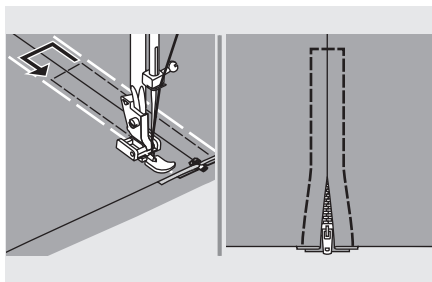

- Stitching around the zipper.



Please Note:

When sewing, be sure that the needle does not touch the zipper, otherwise the needle may bend or break.

- Remove the basting and press.

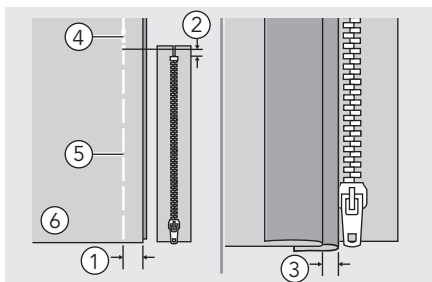

Inserting a side zipper

- Place the right sides of the fabric together. Sew a bottom seam 2cm from the right edge of the zipper bottom stop position. Sew a few stitches in reverse to lock. Increase the stitch length to maximum, set the tension below 2 and baste the remaining length of the fabric.
- Fold back to the left the seam allowance. Turn under the right the seam allowance to form a 3mm fold.

- ① 2cm
- ② 5mm
- ③ 3mm
- ④ Reverse stitches
- ⑤ Basting stitching
- ⑥ Reverse side

Zipper insertion

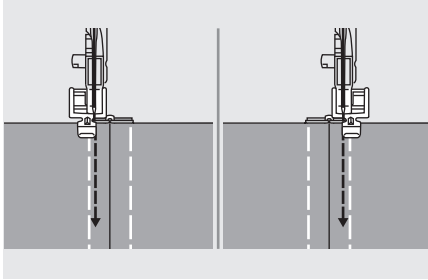

- Attach the zipper foot. Attach the right side of the presser foot pin to the holder when sewing the left side of the zipper. Attach the left side of the presser foot pin to the presser foot holder when sewing the right side of the zipper.

- Sew the zipper to the piece of fabric with the extra 3 mm (1/8 inch), starting from the base of the zipper. When you are about 5 cm (2 inches) from the end of the zipper, stop the sewing machine with the needle lowered (in the fabric), raise the presser foot lever, and then open the zipper and continue sewing.

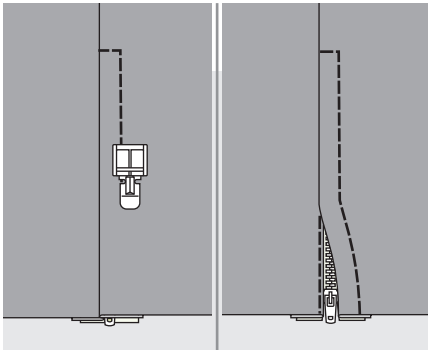

- Turn the fabric right side out, stitch across the lower end and the right side of the zipper.
- Stop about 5cm (2 inches) from the top of the zipper. Remove the basting and open the zipper. Stitch the remaining of the seam.

Gathering

Ideal for clothing as well as home decor. It works best on thin to medium weight fabrics.

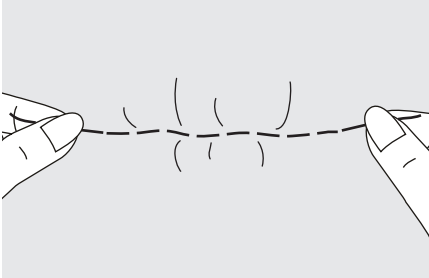

- Set the pattern selection dial to straight stitch.
- Loosen the tension of the upper thread so that the lower thread lies on the underside of the material.
- Sew a single row (or many rows) of straight stitches.
- Pull the lower threads to gather the material.

Free motion darning, embroidery and monogramming

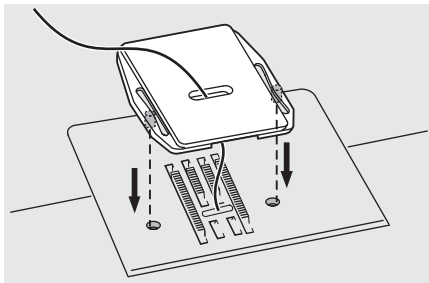

Install the darning plate.

Darning

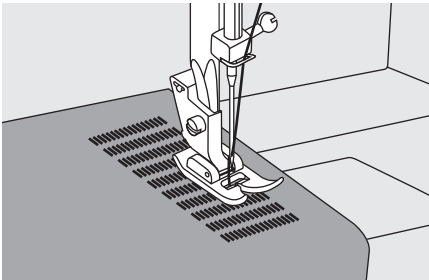

- Turn the stitch selector to straight stitch, center the needle position.
- Position the fabric to be darned under the presser foot together with the under laying fabric to be used.
- Lower the presser foot and sew alternately forward and reverse using the lever.
- Repeat this motion until the area to be darned is filled with rows of stitches.

For reverse sewing instructions, see page 27.

Free motion darning, embroidery and monogramming

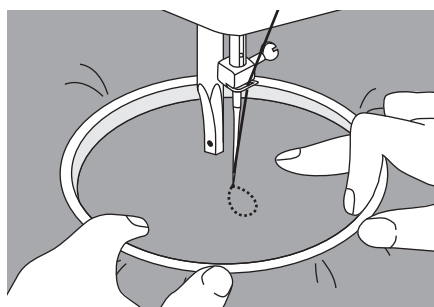
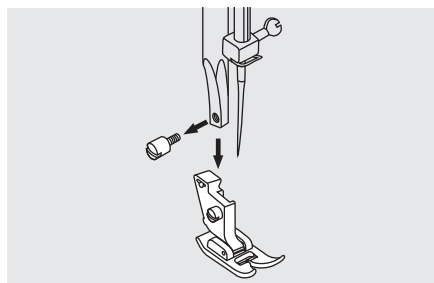

Preparation for embroidering and monogramming

- * Embroider hoop is not included with the machine.
- Install the darning plate, see page 35.
- Remove the presser foot and the presser foot holder.
- Draw the desired lettering or design on the right side of the fabric.
- Stretch the fabric between the embroidery hoop as firmly as possible.
- Place the fabric under the needle. Make sure the presser foot bar is down to its lowest position.
- Turn the balance wheel towards you to bring up the lower thread through the fabric. Sew a few securing stitches at the starting point.
- Hold the hoop with thumb and forefinger of both hands while pressing the material with the middle and third finger and supporting the outside of the hoop with your small finger.

➔ Caution:

Keep fingers away from moving parts, especially needles.

Free motion darning, embroidery and monogramming

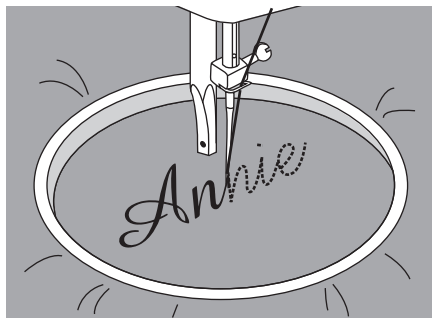

Monogramming

Install the darning plate, see page 35.

Sew at constant speed, moving the embroidery hoop slowly along the lettering.

When the letter is finished secure with reinforcement stitches at the end of the design.

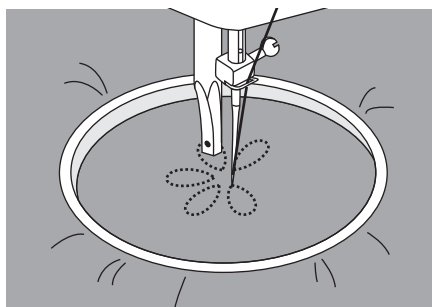

Embroidery

Install the darning plate, see page 35.

Stitch along the outline of the design moving the embroidery hoop. Make sure to maintain a constant speed.

Fill in the design working from the outline towards the inside. Keep the stitches close together.

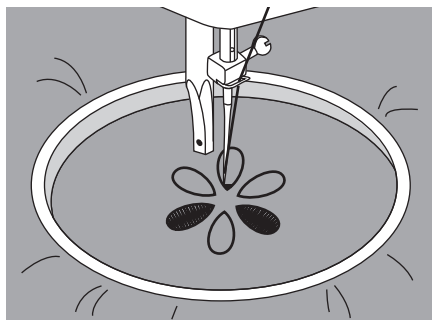

You will get longer stitches by moving the hoop faster and shorter stitches by moving the hoop slower.

Secure with reinforcement stitches at the end of the design.

Applique

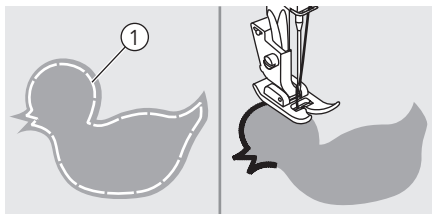

Cut out the applique design and baste it on the fabric.

Sew slowly around the edge of the design.

① Basting

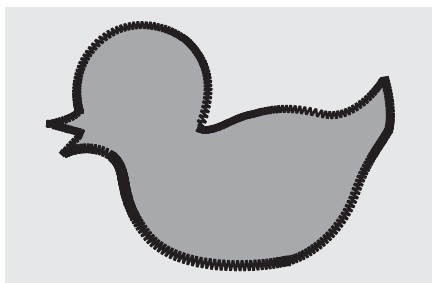

Trim the excess material outside the stitching. Make sure not to cut any stitches.

Remove the basting thread.

Scallop stitching

The wave-shaped repeating pattern, that looks like shells, is called "scalloping". It is used to decorate the collar of blouses and the edges of knitting projects.

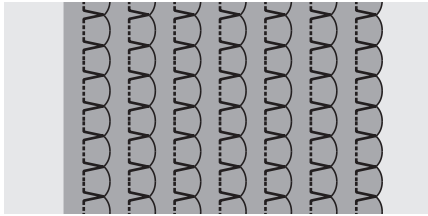
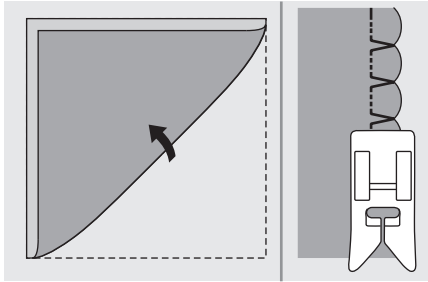

Shell tuck stitching

Use a lightweight fabric (tricot, for example).

Fold and stitch on the bias.

When the needle swings to the right, allow the needle to just clear the folded edge of the fabric.

After stitching, open the fabric and iron press the tucks flat to one side.

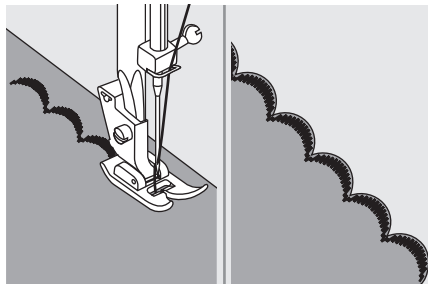

Scallop stitching

Stitch along the edge of the fabric, making sure not to sew directly on the edge of the fabric.

For better results, apply spray starch onto the fabric and press with a hot iron before it is sewn.

Trim along the stitches, be careful not to cut the stitches.

Maintenance

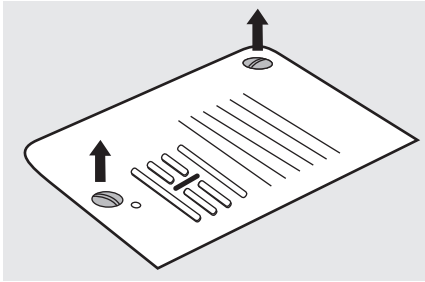

⚠ Attention:

When cleaning the machine, it must always be disconnected from the electricity supply.

Remove the stitch plate:

Turn the handwheel until the needle is fully raised. Open the hinged front cover and unscrew the needle plate screw with the screw driver.

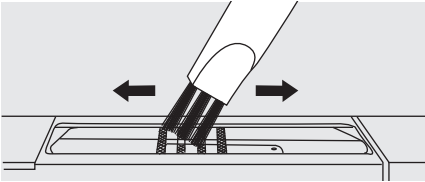

Cleaning the feed dog:

Clean the feed dog and bobbin case with a brush.

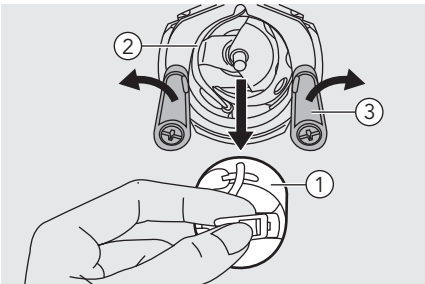

Cleaning and lubricating the hook:

Fabric fluff and threads must be removed regularly.

Remove the bobbin case. Turn the handwheel until the hook race is in the left position. Snap the two hook retaining arms outwards. Remove the hook race cover and the hook and clean with a soft cloth. Lubricate (1-2 drops) with sewing machine oil.

- ① Bobbin case
- ② Hook race
- ③ Hook retaining arms

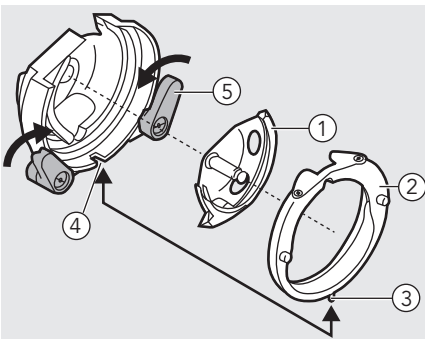

Replace the hook. Attach the hook race cover making sure the bottom pin fits into the notch. Snap back the two hook retaining arms. Insert the bobbin case and bobbin and replace the stitch plate.

- ① Hook
- ② Hook race cover
- ③ Pin
- ④ Notch
- ⑤ Hook retaining arms

Trouble shooting guide

Before calling for service, check the following items. If the problem still persists, contact the place of purchase or your nearest authorized dealer.

Problem	Cause	Correction	Reference
Upper thread breaks	1. The machine is not threaded correctly.	1. Rethread the machine.	16-18
	2. The thread tension is too tight.	2. Reduce the thread tension (lower number).	24-25
	3. The thread is too thick for the needle.	3. Select a larger needle.	21
	4. The needle is not inserted correctly.	4. Remove and reinsert the needle (flat side towards the back).	20
	5. The thread is wound around the spool holder pin.	5. Remove the reel and wind up the thread onto the reel.	11-13
	6. The needle is damaged.	6. Replace the needle.	20
Lower thread breaks	1. The bobbin case is not inserted correctly.	1. Remove and reinsert the bobbin case and pull on the thread. The thread should run easily.	14-15
	2. The bobbin case is threaded wrong.	2. Check both bobbin and bobbin case.	11-15
Skipped stitches	1. The needle is not inserted correctly.	1. Remove and reinsert the needle (flat side towards the back).	20
	2. The needle is damaged.	2. Insert a new needle.	20
	3. The wrong size needle has been used.	3. Choose a needle to suit the thread.	21
	4. The foot is not attached correctly.	4. Check and attach it correctly.	22
	5. The machine is not threaded correctly.	5. Rethread the machine.	16-18
Needle breaks	1. The needle is damaged.	1. Insert a new needle.	20
	2. The needle is not correctly inserted.	2. Insert the needle correctly (flat side towards the back).	20
	3. Wrong needle size for the fabric.	3. Choose a needle to suit the thread and fabric.	21
	4. The wrong foot is attached.	4. Select the correct foot.	-
	5. The needle clamp screw is loose.	5. Use the screwdriver to tighten the screw.	20

Trouble shooting guide

Problem	Cause	Correction	Reference
Needle breaks	6. The presser foot that is used is not appropriate for the type of stitch that you wish to sew.	6. Attach the presser foot that is appropriate for the type of stitch that you wish to sew.	21-22
	7. The upper thread tension is too tight.	7. Loosen the upper thread tension.	24-25
Loose stitches	1. The machine is not correctly threaded.	1. Check the threading.	16-18
	2. The bobbin case is not threaded correctly.	2. Thread the bobbin case as illustrated.	14-15
	3. Needle/ fabric/ thread combination is wrong.	3. The needle size must suit the fabric and thread.	21
	4. The thread tension is wrong.	4. Correct the thread tension.	24-25
Seam gather or pucker	1. The needle is too thick for the fabric.	1. Select a finer needle.	21
	2. The thread tension is too tight.	2. Loosen the thread tension.	24-25
Seam puckering	1. The needle thread tension is too tight.	1. Loosen the thread tension.	24-25
	2. The needle thread is not threaded correctly.	2. Rethread the machine.	16-18
	3. The needle is too heavy for the fabric being sewn.	3. Choose a needle to suit the thread and fabric.	21
	4. If you are sewing on thin fabric.	4. Sew with a stabiliser material under the fabric.	21
Patterns are distorted	1. The correct presser foot is not used.	1. Select the correct foot.	-
	2. The needle thread tension is too tight.	2. Loosen the thread tension.	24-25
The machine jams	1. Thread is caught in the hook.	1. Remove the upper thread and bobbin case, turn the handwheel backwards and forwards and remove the thread remnants.	43
	2. The feed dogs are packed with lint.	2. Remove the stitch plate and clean the feed dogs.	43
The machine is noisy	1. Fluff or oil have collected on the hook or needle bar.	1. Clean the hook and feed dog.	43
	2. The needle is damaged.	2. Replace the needle.	20
	3. Slight humming sound coming from internal motor.	3. Normal.	-

Trouble shooting guide

Problem	Cause	Correction	Reference
The machine is noisy	4. Thread is caught in the hook.	1. Remove the upper thread and bobbin case, turn the handwheel backwards and forwards and remove the thread remnants.	43
	5. The feed dogs are packed with lint.	2. Remove the stitch plate and clean the feed dogs.	43
Uneven stitches, uneven feed	1. Poor quality thread.	1. Select a better quality thread.	21
	2. The bobbin case is threaded wrong.	2. Remove the bobbin case and the thread and reinsert them correctly.	14-15
	3. Fabric has been pulled on.	3. Do not pull on the fabric while sewing, let it be taken up by the machine.	-
The sewing machine doesn't operate	1. The machine is not turned on.	1. Turn on the machine.	9
	2. The machine is not plugged in.	2. Connect the power line plug to the electric outlet.	9



Do not dispose of electrical appliances as unsorted municipal waste, use separate collection facilities.

Contact your local government for information regarding the collection systems available.

If electrical appliances are disposed of in landfills or dumps, hazardous substances can leak into the groundwater and get into the food chain, damaging your health and well-being.

When replacing old appliances with new ones, the retailer is legally obligated to take back your old appliance for disposal at least for free of charge.
