

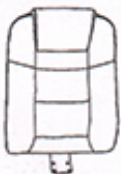

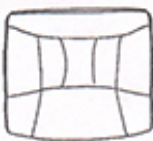



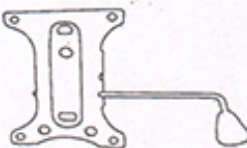

Офисное кресло MF-361

Инструкция по сборке

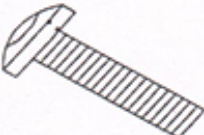
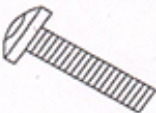
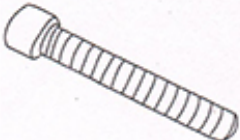
Ax1pc 	Bx1pc 	Cx1pc 	Dx2pc 	Ex1pc 
Fx1pc 	Gx5pc 	Hx4pc  M6x25	Ix4pc  M6x18	Jx4pc  M8x45

Kx4pc 

Lx1pc 

Mx1pc 

Nx1pc 

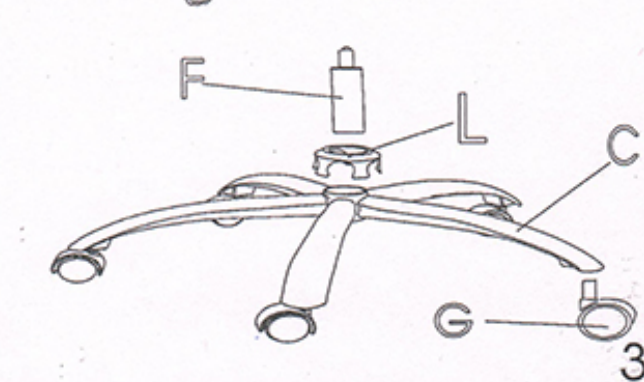
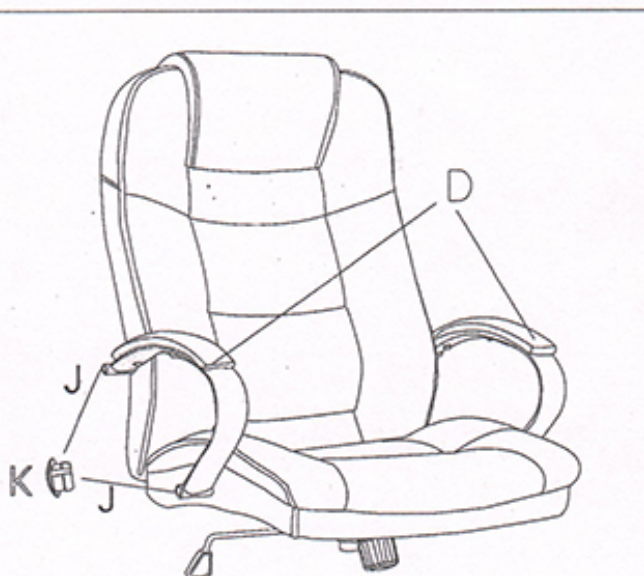
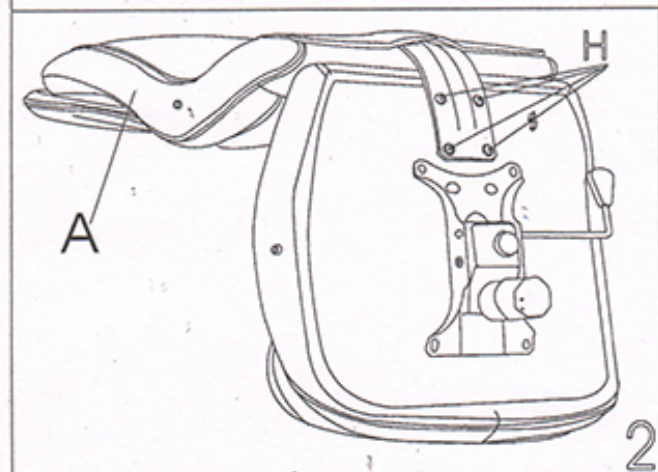
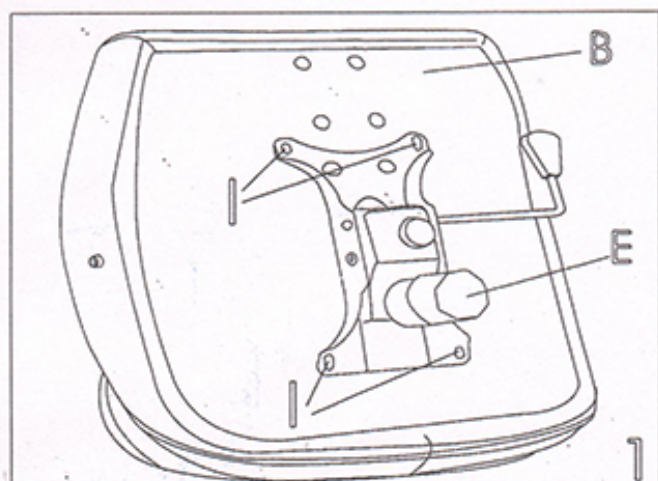

**Для поддержания надежности рекомендуется подтягивать винты каждый месяц.
Во избежание травм не вставляйте ногами на кресло.**