

Liquid Freezer II 360

Multi Compatible All-in-One CPU Water Cooler



General Specifications

Compatibility	Intel® 1700, 1200, 115X, 2011-3*, 2066* *Square ILM AMD® AM5, AM4, AM3(+)
TIM	MX-4 (0.8 g)
Pump & Fan Connector	4-Pin Connector
Weight	1687 g (3 Fans, Radiator, Pump, Tubes)

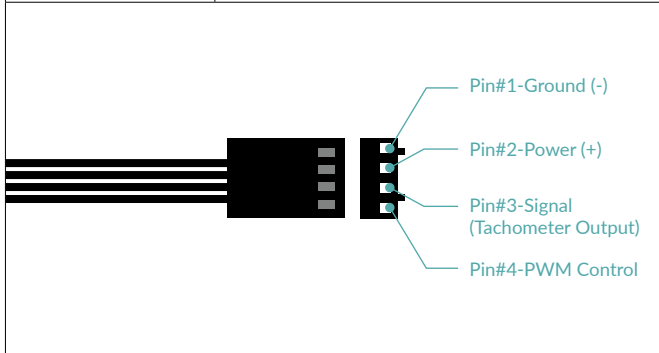

Pump/Cold Plate Specifications

VRM Fan	40 mm, 1000–3000 rpm (Controlled by PWM)
Pump	800–2000 rpm (Controlled by PWM)
Power Consumption	0.5 W–2.7 W Pump and VRM Fan
Tube Length	450 mm
Tube Diameter	Outer: 12.4 mm Inner: 6.0 mm
Dimensions	78 (L) x 53 (W) x 98 (H) mm

Fan Specifications

Speed	200–1800 rpm
Airflow	56.33 cfm 95.7 m³/h
Static Pressure	2.2 mmH ₂ O
Noise Level	0.3 Sone
Fan Dimensions	120 (L) x 120 (W) x 25 (H) mm
Speed Control	Pulse Width Modulation
Bearing	Fluid Dynamic Bearing
Strom/Spannung	0.08 A/12 V

Radiator Specifications

Material	Aluminum
Dimensions	398 (L) x 38 (W) x 120 (H) mm

Shipping Information

Warranty	6 years
Box Dimension	472 mm (L) x 143 mm (W) x 131 mm (H)
Gross Weight	2200 g
SKU	ACFRE00068B
EAN	4895213701983
UPC	872767009875

Liquid Freezer II 360

Multi Compatible All-in-One CPU Water Cooler

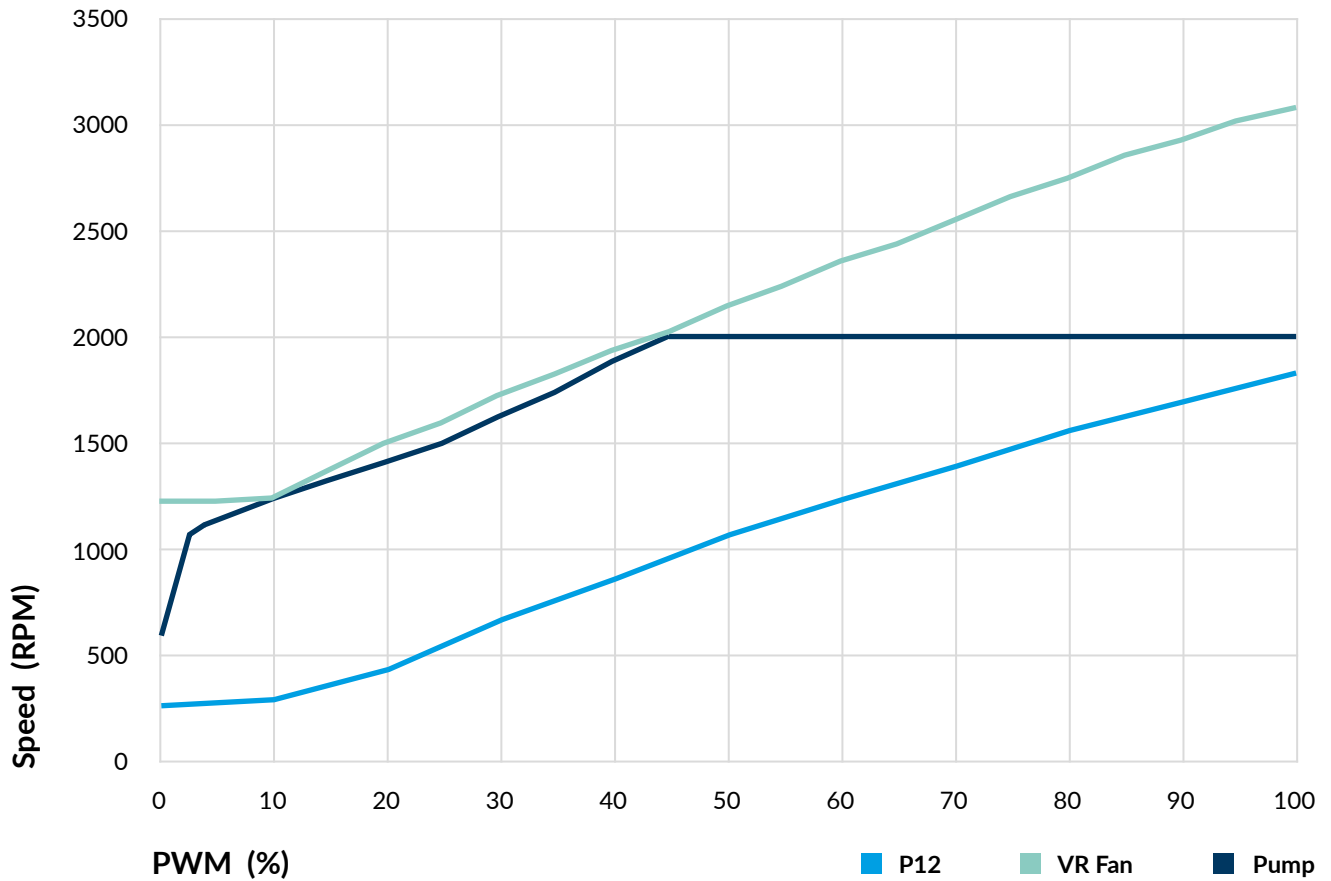

Liquid Freezer II 360

Multi Compatible All-in-One CPU Water Cooler

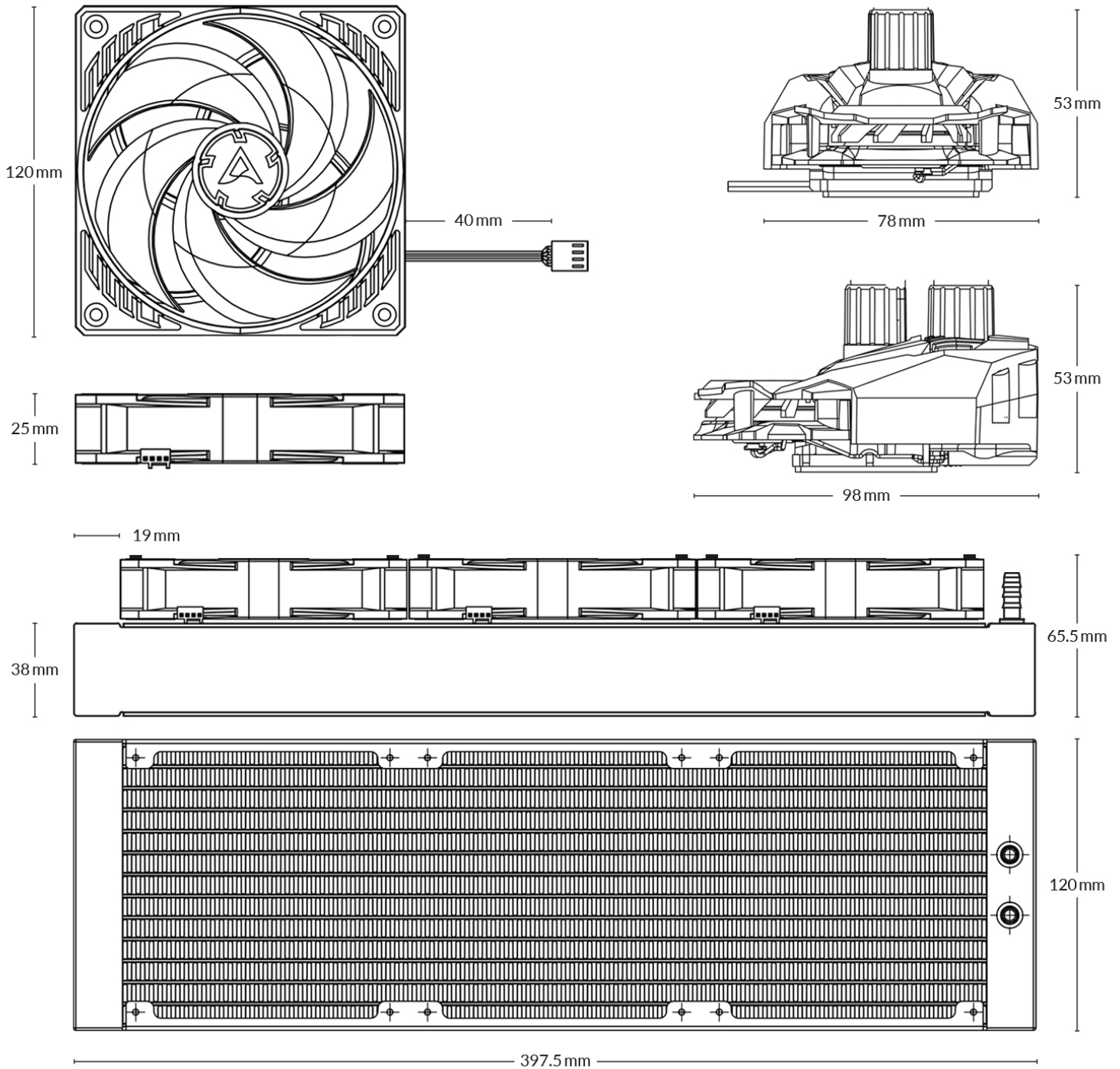

Alle Materialien sind mit den RoHS-Anforderungen kompatibel



Produktinformation



Manual