

Tenda



Network Video Recorder GUI and Web User Guide

Copyright Statement

© 2022 Shenzhen Tenda Technology Co., Ltd. All rights reserved.

Tenda is a registered trademark legally held by Shenzhen Tenda Technology Co., Ltd. Other brand and product names mentioned herein are trademarks or registered trademarks of their respective holders. Copyright of the whole product as integration, including its accessories and software, belongs to Shenzhen Tenda Technology Co., Ltd. No part of this publication can be reproduced, transmitted, transcribed, stored in a retrieval system, or translated into any language in any form or by any means without the prior written permission of Shenzhen Tenda Technology Co., Ltd.

Disclaimer

Pictures, images and product specifications herein are for references only. To improve internal design, operational function, and/or reliability, Tenda reserves the right to make changes to the products without obligation to notify any person or organization of such revisions or changes. Tenda does not assume any liability that may occur due to the use or application of the product described herein. Every effort has been made in the preparation of this document to ensure accuracy of the contents, but all statements, information and recommendations in this document do not constitute a warranty of any kind, express or implied.

Preface

Thank you for choosing Tenda! Please read this guide before you manage the Network Video Recorder (NVR).

Applicable models



This user guide is applicable to all NVR series products. Unless otherwise specified, N3L-4H is used for illustration here.

Conventions

The typographical elements that may be found in this document are defined as follows.

Item	Presentation	Example
Cascading menus	>	Playback > File
Parameter and value	Bold	Set User Name to Tom .
Variable	Italic	Format: <i>XX:XX:XX:XX:XX:XX</i>
UI control	Bold	On the Policy page, click the OK button.
Message	“ ”	The “Success” message appears.

The symbols that may be found in this document are defined as follows.

Symbol	Meaning
 NOTE	This format is used to highlight information of importance or special interest. Ignoring this type of note may result in ineffective configurations, loss of data or damage to the device.
 TIP	This format is used to highlight a procedure that will save time or resources.

For more documents

If you want to get more documents of the device, visit www.tendacn.com and search for the corresponding product model.

The related documents are listed as below.

Document	Description
Datasheet	It introduces the basic information of the NVR, including product overview, selling points, and specifications.
Quick Installation Guide	It introduces how to set up the device quickly for internet access, the descriptions of LED indicators, ports, and buttons, FAQ, statement information, and so on.
GUI and Web User Guide	It introduces how to set up GUI and web functions of the device for more requirements, including all functions on the GUI and web of the device.
App User Guide	It introduces how to use the TDSEE app to manage the NVR.

Technical Support

If you need more help, contact us by any of the following means. We will be glad to assist you as soon as possible.



Hotline

Global: (86) 755-27657180

(China Time Zone)

United States: 1-800-570-5892

(Toll-Free: 7 x 24 hours)

Canada: 1-888-998-8966

(Toll Free: Mon - Fri 9 am - 6 pm
PST)

Hong Kong: 00852-81931998



Email

support@tenda.com.cn



Website

<https://www.tendacn.com/>

Revision History

Tenda is constantly searching for ways to improve its products and documentation. The following table indicates any changes that might have been made since the user guide was released.

Version	Description	Date
v1.1	<ol style="list-style-type: none">1. Web management added2. PTZ control added3. Such network configuration functions as PoE configuration, port configuration, DDNS and UPnP are added.4. DST added5. Optimize sentence expression	2022-01-17
v1.0	Original publication.	2021-12-17

Contents

1	Product Feature.....	1
	1.1 Basic Function	1
	1.2 Local Monitoring	2
	1.3 File Management	2
	1.4 Recording and Playback	2
	1.5 Backup.....	3
	1.6 Alarm and Exception Management	3
	1.7 Other Local Function	4
	1.8 Network Function.....	4
2	Startup and Shutdown	5
	2.1 Startup.....	5
	2.2 Shutdown	6
3	Activate and Quick Setup	7
	3.1 Local Activation and Quick Setup.....	7
	3.2 Web Activation	12
4	Local Management.....	15
	4.1 Local Login.....	15
	4.2 GUI Introduction	17
	4.2.1 Mouse Operation	17
	4.2.2 Layout.....	18
	4.2.3 Frequently-used Elements	19
	4.3 General Operation.....	20
	4.3.1 Logout	20
	4.3.2 Reboot.....	20

4.3.3 Reset Login Password	21
4.3.4 Check Alarm Notification of Exception Detection.....	23
4.4 Live View	24
4.4.1 Overview	24
4.4.2 Quick Operation	26
4.4.3 Quickly Add a Camera	27
4.4.4 Instant Playback	31
4.4.5 Zoom in	33
4.4.6 Switch Window Division Mode	34
4.4.7 PTZ Control.....	35
4.4.8 Check Stream Info	45
4.4.9 Modify Channel Sequence	46
4.5 Playback.....	47
4.5.1 Channel Playback	47
4.5.2 File Playback.....	51
4.5.3 Add Tag.....	62
4.5.4 Tag Playback	65
4.5.5 Clip and Export the Recording File	72
4.6 Configuration.....	76
4.6.1 Show or Hide Professional Setting	76
4.6.2 Channel Management.....	77
4.6.3 Storage Management.....	97
4.6.4 Alarm Management	107
4.6.5 Network Configuration.....	118
4.6.6 System Configuration	143
4.7 Maintenance	160
4.7.1 Devie Info	160
4.7.2 Channel Info	161

4.7.3 Device Upgrade	163
4.7.4 System Log	166
4.7.5 Diagnosis	172
4.7.6 Device Maintenance	177
5 Web Management	180
5.1 Web Login.....	180
Scenario 1: With DHCP Server in the Network	180
Scenario 2: Without DHCP Server in the Network.....	183
5.2 Live View	188
5.2.1 Overview	188
5.2.2 Preview the Monitoring Image of Each Channel	190
5.2.3 Zoom in	192
5.3 Playback.....	194
5.3.1 Overview	194
5.3.2 Play Back the Specific Channel.....	195
5.4 Configuration.....	197
5.4.1 Channel	197
5.4.2 Storage Management.....	197
5.4.3 Alarm Recording.....	204
5.4.4 Network Configuration.....	206
5.5 System Management	207
5.5.1 Device Info.....	207
5.5.2 Device Log	208
5.5.3 System Configuration	209
5.5.4 System Maintenance.....	211
5.5.5 User Management	214

1

Product Feature

1.1 Basic Function

- Connectable to cameras of multiple brands.
- Support H.265 video encoding standard, allowing simultaneous connection of the H.265 and H.264 cameras.
- Support H.264+ and H.265+ video coding standards.
- Adopt the standard ONVIF protocol.
- Support main stream and sub-stream live view for each channel.
- Support the maximum resolution of 8 MP for each channel.
- Allow independent adjustment on video coding parameters of each channel, such as the resolution, frame rate and bit rate.
- Support quick connection of cameras.
- Support the Tenda camera upgrade.
- Support such functions as smart search, playback and backup, which can effectively improve the efficiency of recording retrieval and playback.

1.2 Local Monitoring

- Provide VGA and HDMI high-definition resolution display output.
- Support parallel live view and playback of different channels under multi-screen.
- Support 1/4/8/9/16 channel image live view.
- Support to adjust the live view channel sequence.
- Support quick setting operation on the live view page.
- Support multiple live view modes with customized auto-switch dwell time.
- Allow quick adding the camera on the live view page.
- Support PTZ control, including setting and calling of preset and patrol.

1.3 File Management

- Support up to 10TB hard disk drive (HDD) with the SATA interface.
- Support the local and remote HDD detection function.

1.4 Recording and Playback

- Support simultaneous recording of main stream and sub-stream.
- Support two recording modes: Overwrite and non-overwrite.
- Support normal recording and alarm recording.
- Support post-record of alarm recording.
- Support the setting of 8 recording periods every day, and the independent setting of recording modes in different periods.
- Support distinguishing recording types through colors, and quickly display and playback through ticking recording types.
- Support searching recording by such methods as channel number, recording type, file

type, start time and end time.

- Support adding tags to play back recordings, searching and playing back according to tags.
- Support scrolling up or down the mouse to zoom in or out playback time bar.
- The playback function supports pause, speed up, speed down, fast forward/backward and the mouse clicking locate.
- Support local zoom in any area through scrolling up or down the mouse during single-channel playback.

1.5 Backup

- Support backup through a USB port.
- Support batch and clip backup when playback.
- Support system log backup.

1.6 Alarm and Exception Management

- Alarm for such types as motion detection, channel error, unauthorized access, internet interruption, IP address conflict, no HDD, HDD error and insufficient HDD space.
- Alarms will trigger such actions as single-screen display, app alarm notification, alarm email, and any channel recording.
- Support firmware watchdog. The system can be automatically rebooted when it runs abnormally.

1.7 Other Local Function

- The administrator is allowed to create multiple users and set their permissions. The permissions can be refined to the channel.
- Support quick retrieval of multiple types of logs, including information, exception, operation, configuration and alarm.

1.8 Network Function

- Provide one self-adaptive 10/100 Mbps Ethernet uplink port.
- Support TCP and IP protocol clusters, such as DHCP, DNS, NTP, SMTP, DDNS and HTTPS.
- Support the standard ONVIF protocol.
- Support web management. Including preview monitoring, play back video, PTZ control, alarm settings and system management.
- Support remote web management.

2 Startup and Shutdown

2.1 Startup



Use the included power adapter to power on the NVR. An abnormal power supply will cause running failure or even damage to the NVR.

Power on the NVR to start it using the included power adapter.

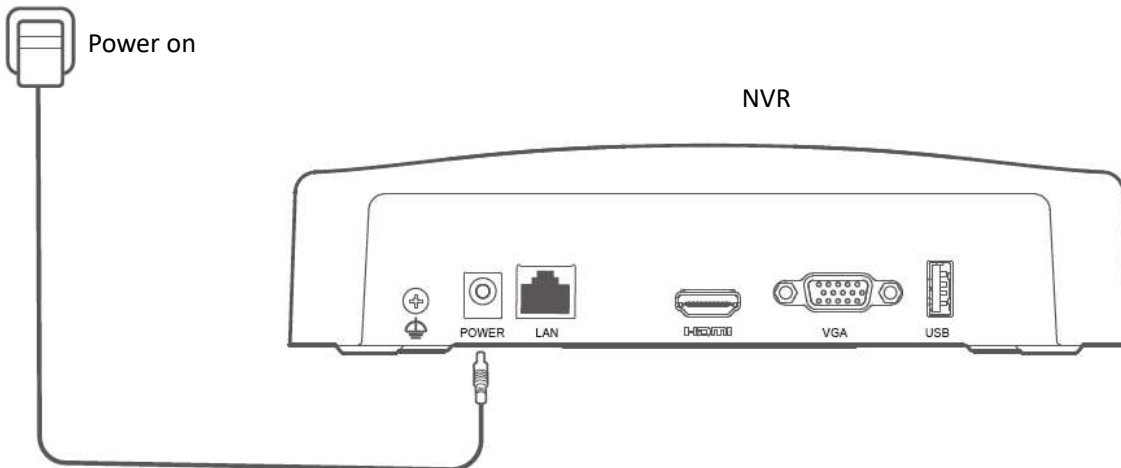



2.2 Shutdown



Do not directly cut off the power of the NVR to force a shutdown; otherwise, it may damage the HDD, lead to the loss of videos, or even damage the NVR.

Step 1 Connect the mouse and monitor to the NVR.

Step 2 Click  in the upper-right corner on the GUI of the NVR (exit the full-screen interface), click **Shutdown** , and then click **OK**.

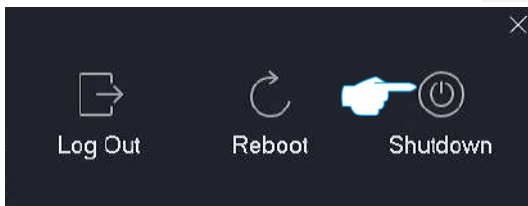

Step 3 When “The Device is Shutdown. Please Cut Off the Power” that appears on the screen, unplug the power adapter of the NVR.

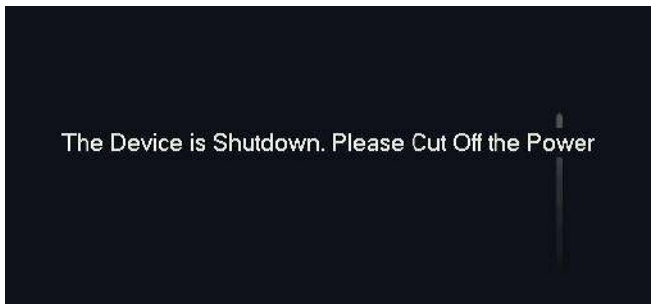

---End

3 Activate and Quick Setup

You can activate the NVR upon the first use of the NVR or after resetting the NVR. Tenda NVR supports local activation and web activation.

- Local activation: After the activation is completed, you can enter the quick setup page to quickly set up the monitoring network.
- Web activation: After the activation is completed, you can directly enter the **Live View** page.

3.1 Local Activation and Quick Setup

Step 1 Power on the NVR, connect the monitor to the VGA port or HDMI port of the NVR using a VGA/HDMI cable, then connect the mouse to the USB port of the NVR.

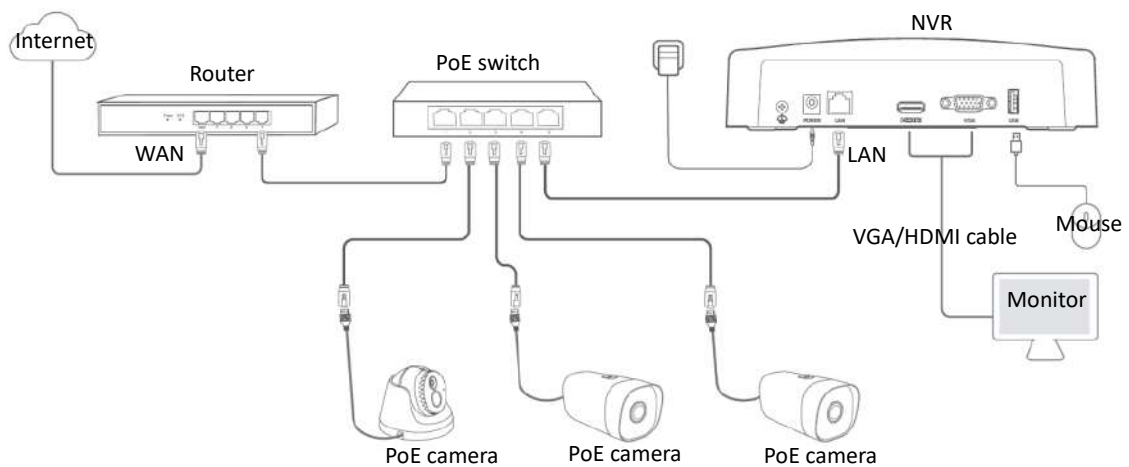

Step 2 Set login **Password** and **Confirm Password**, enter your **Email Address**, and then click **Activate**.

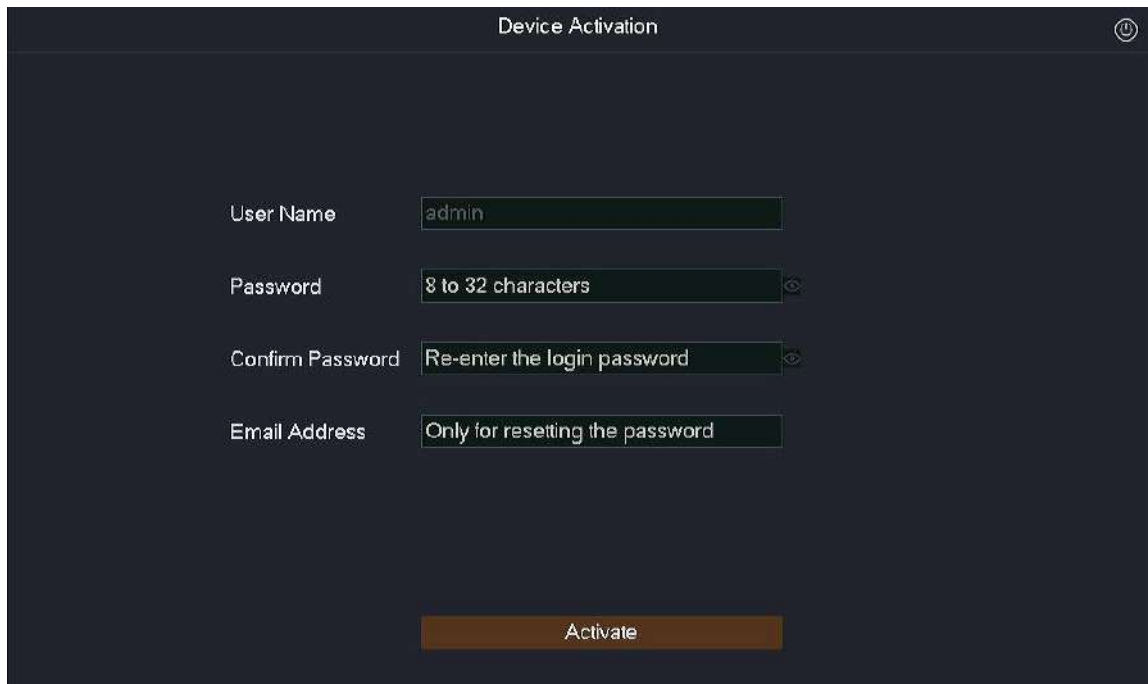

The screenshot shows a dark-themed window titled "Device Activation" with a close button in the top right corner. It contains four input fields: "User Name" with the text "admin", "Password" with the placeholder "8 to 32 characters" and a visibility icon, "Confirm Password" with the placeholder "Re-enter the login password" and a visibility icon, and "Email Address" with the placeholder "Only for resetting the password". A large "Activate" button is centered at the bottom of the form.

Step 3 If you want to use a pattern to unlock the GUI, please draw an unlock pattern. Otherwise, click **Do Not Use Unlock Pattern** and skip to **Step 4**.

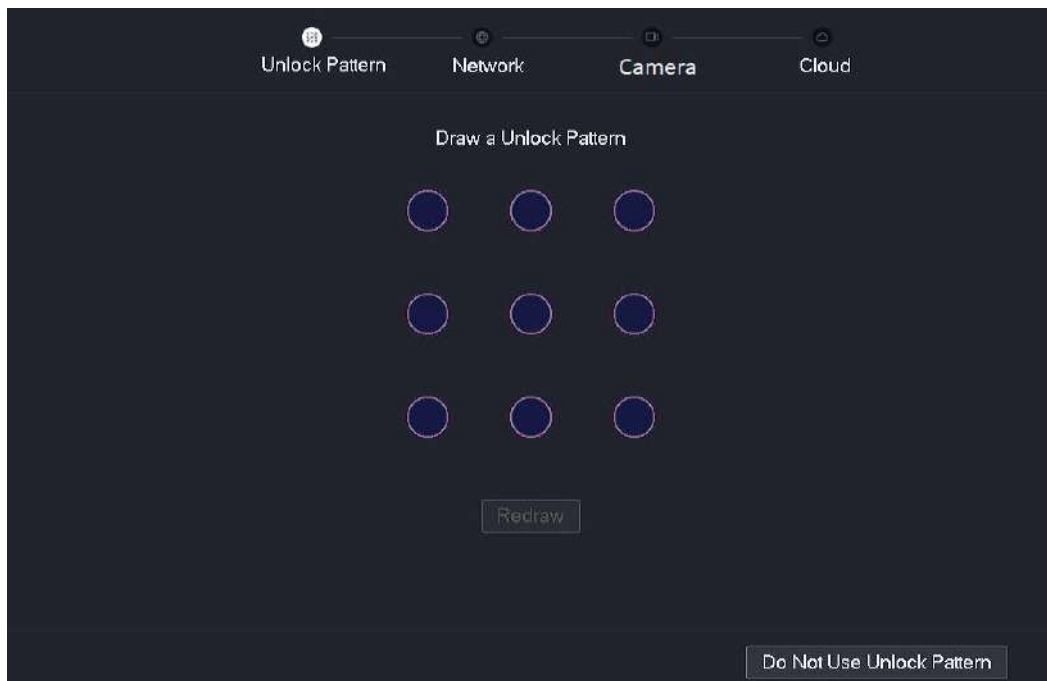

The screenshot shows a dark-themed screen with a navigation bar at the top containing four options: "Unlock Pattern" (selected), "Network", "Camera", and "Cloud". Below the navigation bar, the text "Draw a Unlock Pattern" is displayed. A 3x3 grid of nine blue circles is shown for drawing a pattern. A "Redraw" button is located below the grid. At the bottom right, there is a button labeled "Do Not Use Unlock Pattern".

- Step 4** Ensure that the connection status is **Connected**, and enable the **Auto add LAN cameras** function as required.
- If you want to automatically add the camera on the LAN port of the NVR, click **Next**. Skip to **Step 6**.
 - If you want to manually add the camera on the LAN port of the NVR, disable the **Auto add LAN cameras** function, then click **Next**.



If the connection status is **Disconnected**, try the following solutions:

- Ensure that the LAN port of the NVR is connected properly.
- Ensure that the router to which the NVR is connected has enabled the DHCP server function.

Unlock Pattern	Network	Cloud
Connection Status	Connected	
Auto add LAN cameras	<input checked="" type="checkbox"/>	
DHCP	<input checked="" type="checkbox"/>	
IP Address	192 · 168 · 0 · 188	
Subnet Mask	255 · 255 · 255 · 0	
Default Gateway	192 · 168 · 0 · 1	

Previous Next

Step 5 Add the camera.

Select the camera you want to add in the **Online Camera** list, and click **Add**. Wait until the camera appears in the **Added Camera** list and the status is **Online**, and click **Next**.



- Ensure that the IP address of the camera to be added and the IP address of the NVR is in the same network segment.
- If the user name and password of the camera to be added are different from the NVR, please click , fill in the related information, and then click **Add**.

Auto add LAN cameras

Online Camera

No.	IP Address	Model	Status	S/N	Protocol	Port	Operation
<input checked="" type="checkbox"/> 1	192.168.0.149	IC7	Online		ONVIF	6688	
<input checked="" type="checkbox"/> 2	192.168.0.155	IC6	Online		ONVIF	6688	

Added Camera Remaining Bandwidth: 60.0Mbps

Channel	Channel Name	IP Address	Model	Status	S/N	Version	Protocol Port	Operation
Empty								

Step 6 Ensure that the cloud status is **Online** and click **OK**.



- If the cloud status is **Offline**, please ensure that the router to which the NVR is connected can access the internet and the filter function is disabled.
- You can also manage the NVR through the **TDSEE** app. Please refer to [Manage the NVR through TDSEE App](#) for details.

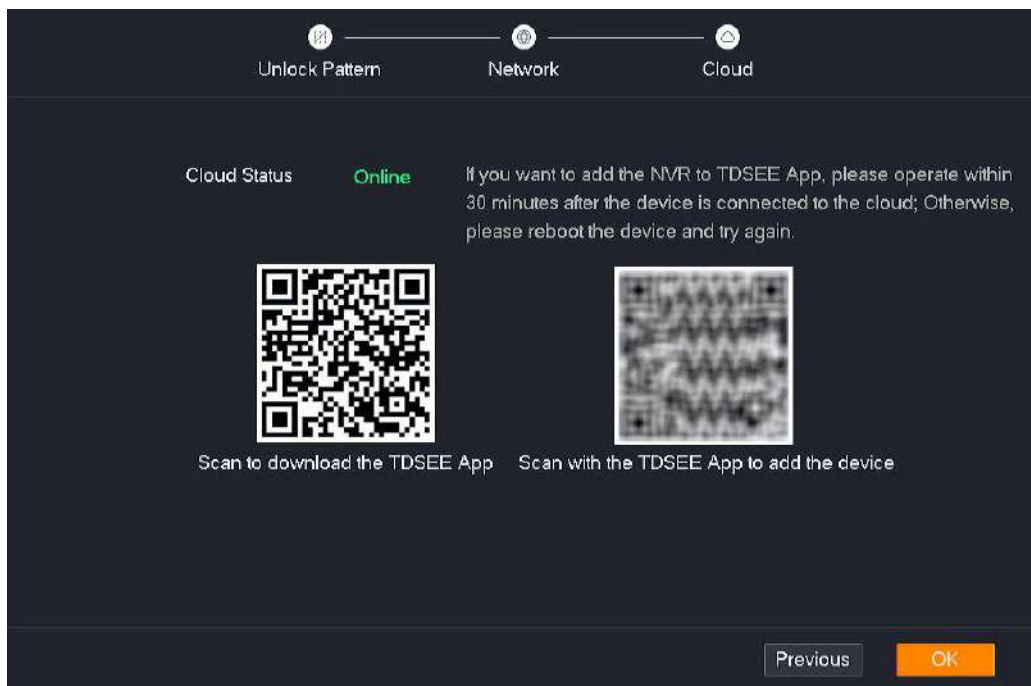

---End

After the activation is completed, you can preview real-time videos, play back the recordings and manage monitoring devices.

3.2 Web Activation

Step 1 Connect the computer to the switch or router that is connected to the NVR.

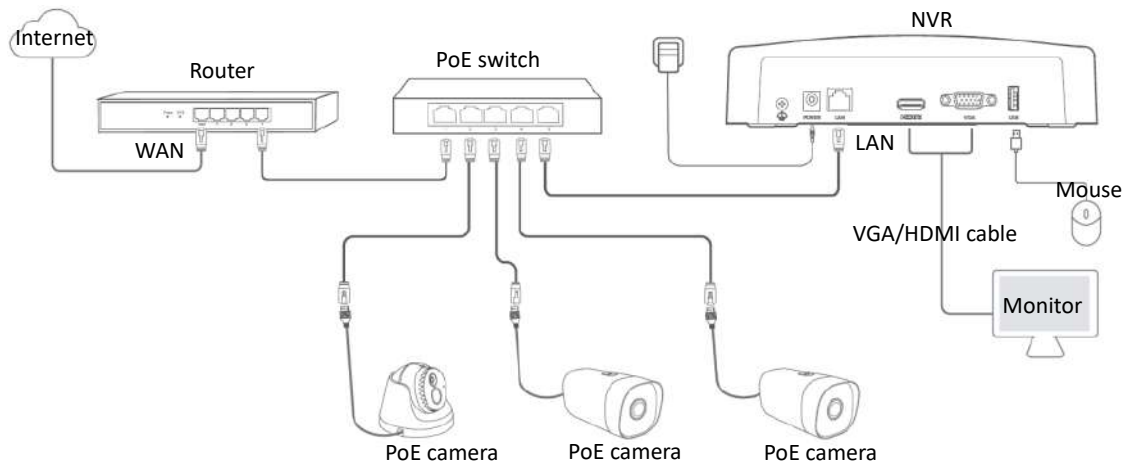

Step 2 Set the IP address of the computer to 192.168.1.X (X indicates 2 to 253, and is unused by other devices.)

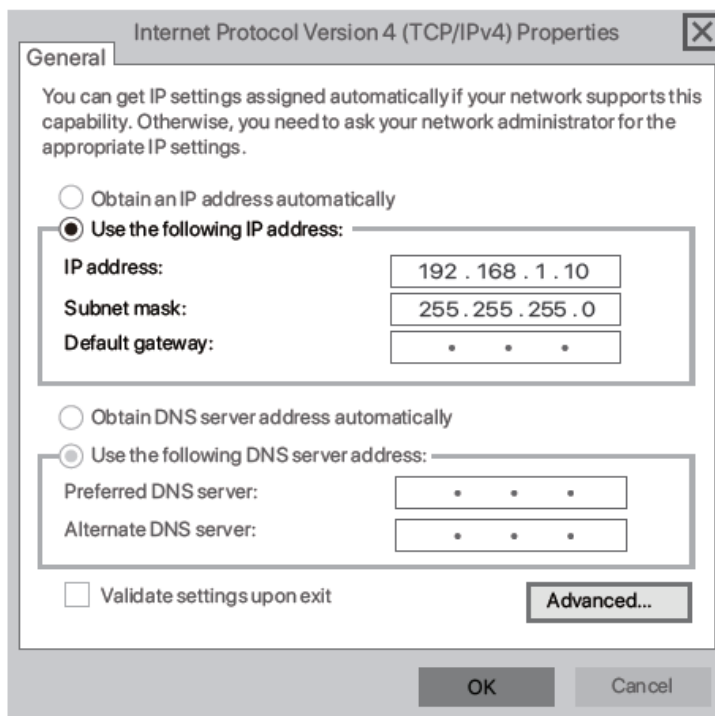

Step 3 Start a web browser on the computer, input the IP address of the NVR (default: 192.168.1.254) in the address bar, and press **Enter**.

The NVR supports HTTPS secure login. When you access the web UI of the NVR, the browser may prompt that the address is not safe, just continue. Here takes Google Chrome as an example, please click **Advanced** → **Proceed to 192.168.1.254 (unsafe)**.

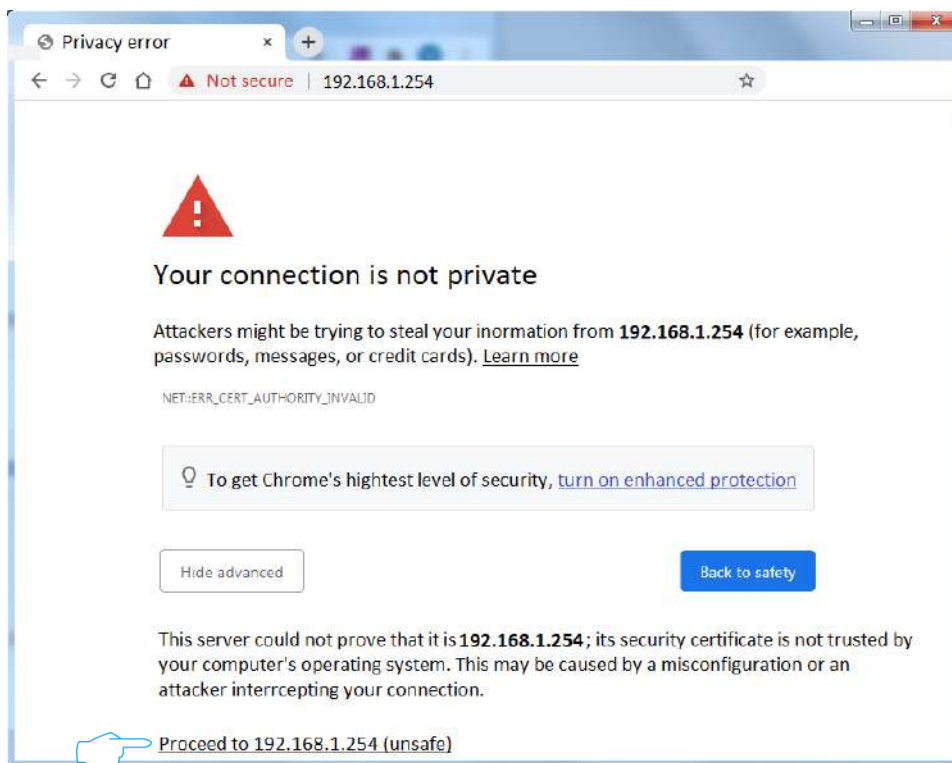
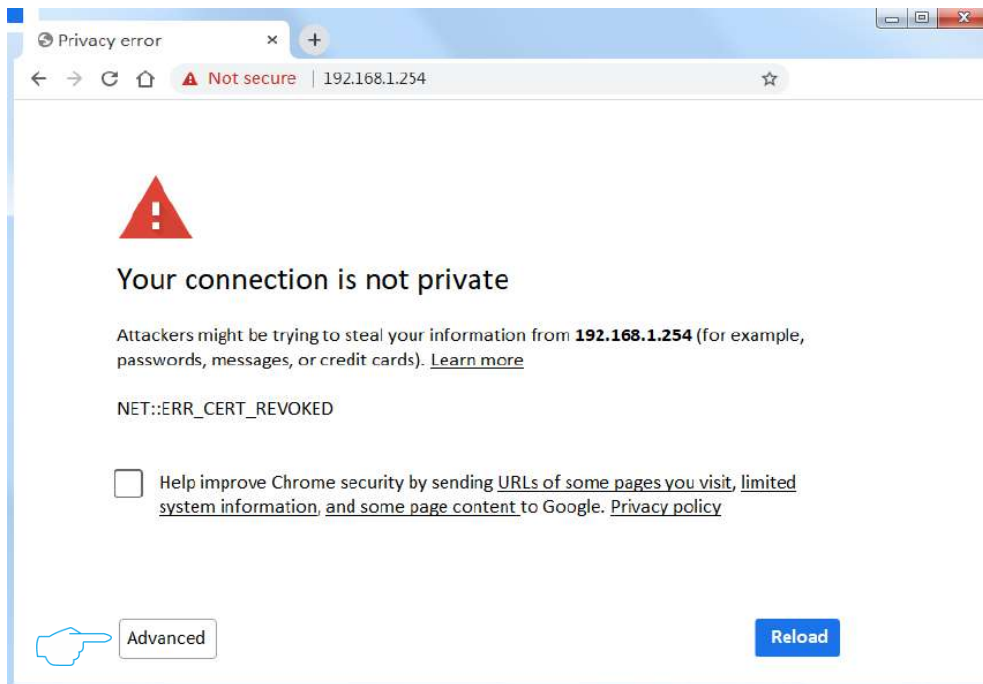

Step 4 Set the login **Password** and **Confirm Password**, enter your **Email Address**, and click **Activate**.

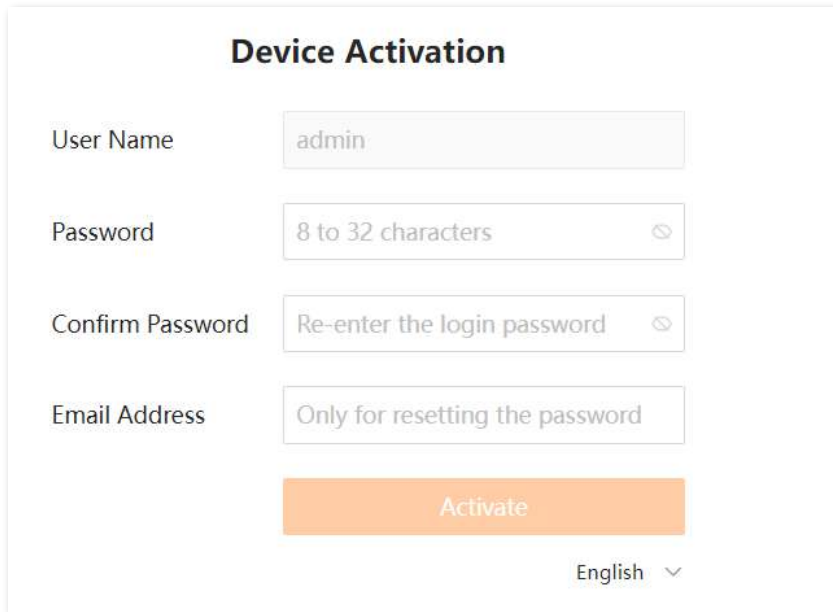

The image shows a 'Device Activation' form with the following fields and elements:

- User Name:** A text input field containing the value 'admin'.
- Password:** A text input field with a placeholder '8 to 32 characters' and a toggle icon on the right.
- Confirm Password:** A text input field with a placeholder 'Re-enter the login password' and a toggle icon on the right.
- Email Address:** A text input field with a placeholder 'Only for resetting the password'.
- Activate:** An orange button with the text 'Activate'.
- Language:** A dropdown menu showing 'English' with a downward arrow.

---End

After the activation is completed, if you want to enter the web UI, you need to log in again. Please refer to [Web Login](#) for details.

4 Local Management

4.1 Local Login

Step 1 Ensure that the NVR is powered on and working properly, connect the VGA port or HDMI port of the monitor to the VGA port or HDMI port of the NVR using a VGA/HDMI cable, then connect the mouse to the USB port of the NVR.

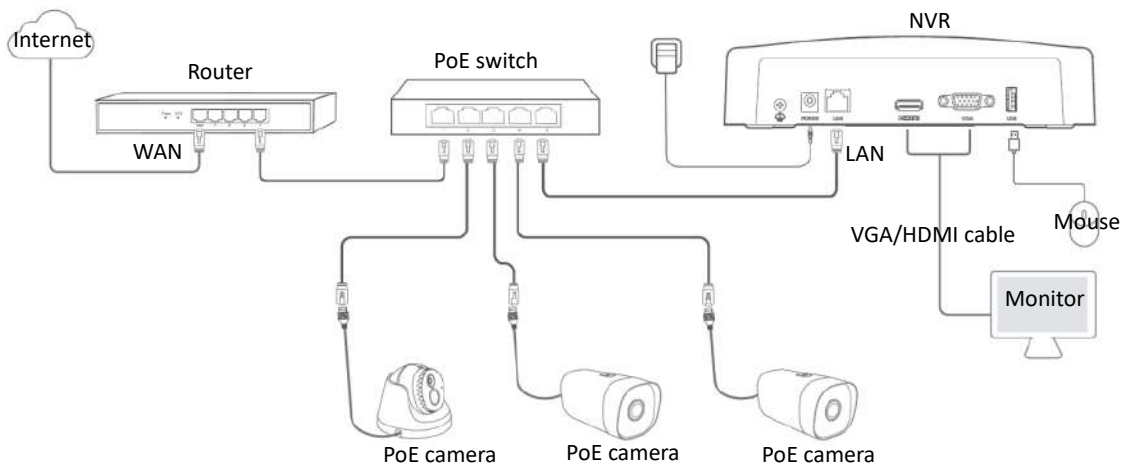

Step 2 Draw an unlock pattern on the monitor or enter the login password to access the GUI.

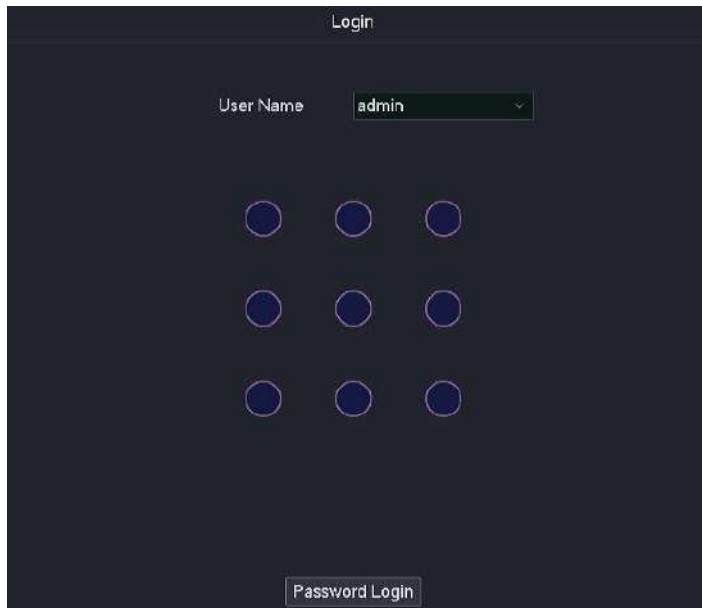

---End

Log in to the GUI successfully. You can perform settings as required.

4.2 GUI Introduction

4.2.1 Mouse Operation

You can perform settings of the device with the mouse after connecting the mouse to the device. The following table describes the main operations of the mouse.

Operation	Description
Single left-click	<ul style="list-style-type: none"> - Select a target. - Confirm content.
Double left-click	<ul style="list-style-type: none"> - Switch between single-screen and multi-screen under live view status. - Play back the recording file.
Left drag	<p>Hold the left key of the mouse and drag the mouse.</p> <ul style="list-style-type: none"> - Draw an unlock pattern. - Draw an area range. - Adjust the channel sequence on the live view page.
Single right-click	<ul style="list-style-type: none"> - Display the quick settings menu. - Exit full-screen playback.
Scroll-wheel up	<ul style="list-style-type: none"> - Zoom in a target area. - Select folded drop-down list options. - Increase volume.
Scroll-wheel down	<ul style="list-style-type: none"> - Zoom out target area. - Select folded drop-down list options. - Decrease volume.

4.2.2 Layout

The GUI of the NVR consists of two sections, including the navigation bar and the configuration area. See the following figure.

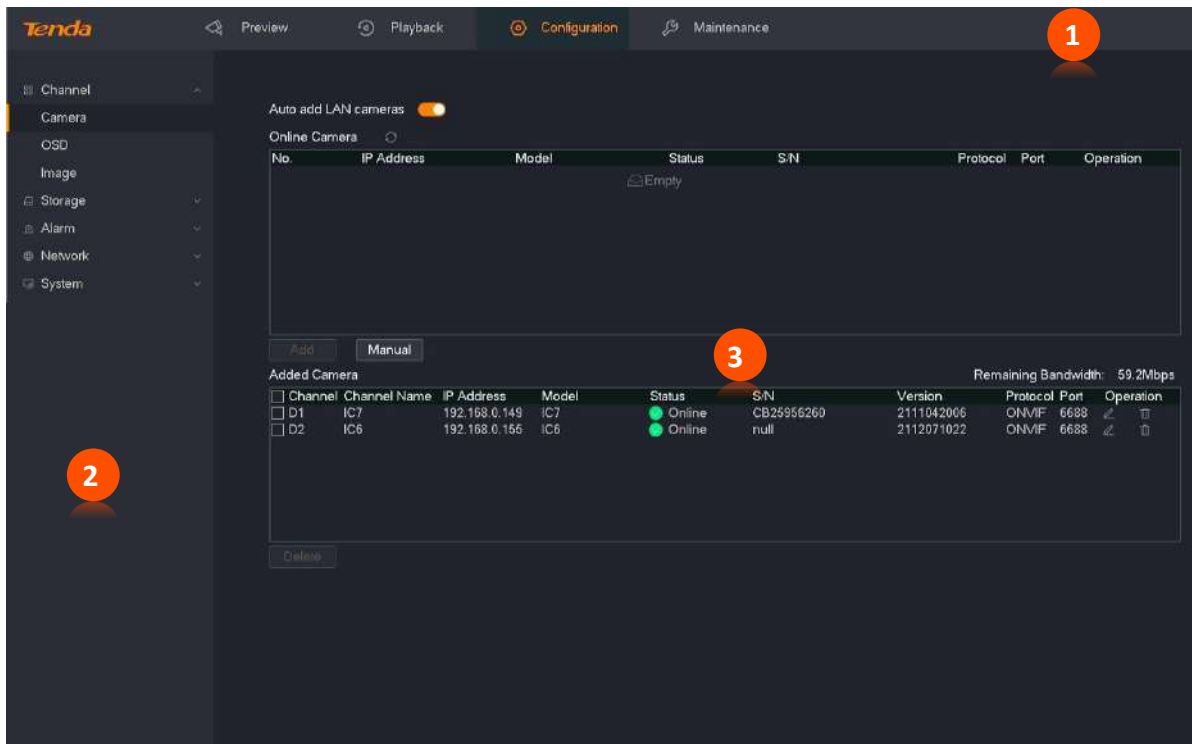



Features and parameters in gray indicate that they are not available or cannot be changed under the current configuration.

NO.	Name	Description
1	Navigation bar	It is used to display the function menu of the NVR. Users can select functions in the navigation bar and then the configuration appears in the configuration area.
2		
3	Configuration area	It is used to view or modify your configuration.

4.2.3 Frequently-used Elements

The following table describes the frequently-used buttons available on the GUI of the NVR.

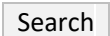

Button	Description
	It is used to save the configuration on the current page and enable the configuration to take effect.
	It is used to cancel the changes you did before.
	It is used to search for the matched contents.

4.3 General Operation

4.3.1 Logout

The system will exit from the current operation menu to the live view screen after you log out. When you re-enter the settings page, the user name and password need to be verified.

Step 1 Connect the mouse and monitor to the NVR.

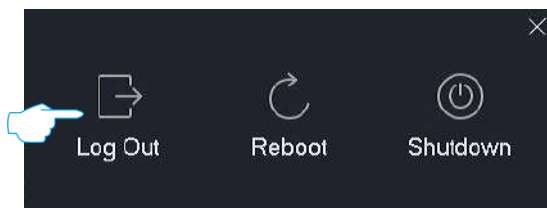

Step 2 Click  in the upper right corner on the GUI of the NVR (exit the full-screen interface), click **Log Out** , and then click **OK**.



---End

4.3.2 Reboot

Step 1 Connect the mouse and monitor to the NVR.

Step 2 Click  in the upper right corner on the GUI of the NVR (exit the full-screen interface), click **Reboot** , and then click **OK**.

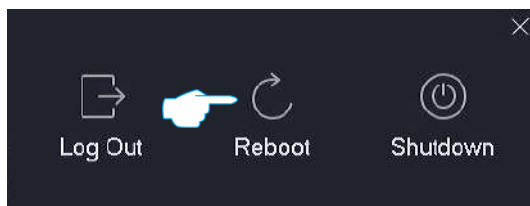

---End

4.3.3 Reset Login Password

If you forgot your login password, you can reset it.



You are recommended to reset your password through TDSEE App. If you did not reserve an email address when activating the NVR, you are recommended to add an email address to the administrator account on the [User Management](#) page.

Step 1 Click **Forgot Password?** on the login page.

Step 2 Follow the on-screen instructions to obtain and enter the verification code, and click **Reset**.

Method 1: Use the TDSEE App

- Optional. Scan the QR code on the right, download and install the TDSEE App.
- Run the TDSEE App, register and log in with the reserved Email address 143****@qq.com. Navigate to Me > General Tools > Reset Device Password, and scan the QR code on the left. The verification code will be shown in the TDSEE App.
- Enter the verification code in the text field on the left, and click Reset.

Method 2: Contact Tenda technical support

- Scan the QR code on the left to get the security code, or take a photo of the QR code.
- Send the security code or the photo of the QR code to Tenda technical support (Email: support@tenda.com.cn). Tenda technical support will send you the verification code.
- Enter the verification code in the text field on the left, and click Reset.

Step 3 Follow the on-screen instructions to set a new login password, and click **Save**.

The screenshot shows a 'Reset Password' dialog box with the following fields and options:

- User Name: admin
- New Password: 8 to 32 characters
- Confirm Password: Re-enter the login password
- Sync Password to Cameras:
- Unlock Pattern:

Buttons: Cancel, Save

---End



4.3.4 Check Alarm Notification of Exception Detection

If you want to check the exception alarm notification, you can click the alarm icon  on the upper-right corner of the GUI (a red dot on the upper right of the icon indicates that there is a new alarm). Please configure the linkage mode of the related exception type as **Pop-up Window** on the [Exception Detection](#) page first.

After clicking the alarm icon  on the upper-right corner of the GUI, the following figure appears.



If the content of the **Channel** parameter is empty, it indicates that the alarm notification does not involve the channel. If the content of the **Handle** parameter is empty, it indicates that does not support handling here, or the problem no longer exists.

Alarm time	Alarm/Error	Channel	Handle
2021-10-30 11:13:48	Channel error	D3	
2021-10-30 11:13:09	Channel error	D2	
2021-10-30 11:13:09	Channel error	D1	
2021-10-30 11:03:48	Disconnected from the i...		

Parameter description

Parameter	Description
Alarm time	It specifies the time when an alarm event occurs.
Alarm/Error	It specifies the alarm type.
Channel	It specifies the channel of triggering an alarm.
Handle	Click  to redirect to the corresponding page to handle the exceptions.

4.4 Live View

4.4.1 Overview







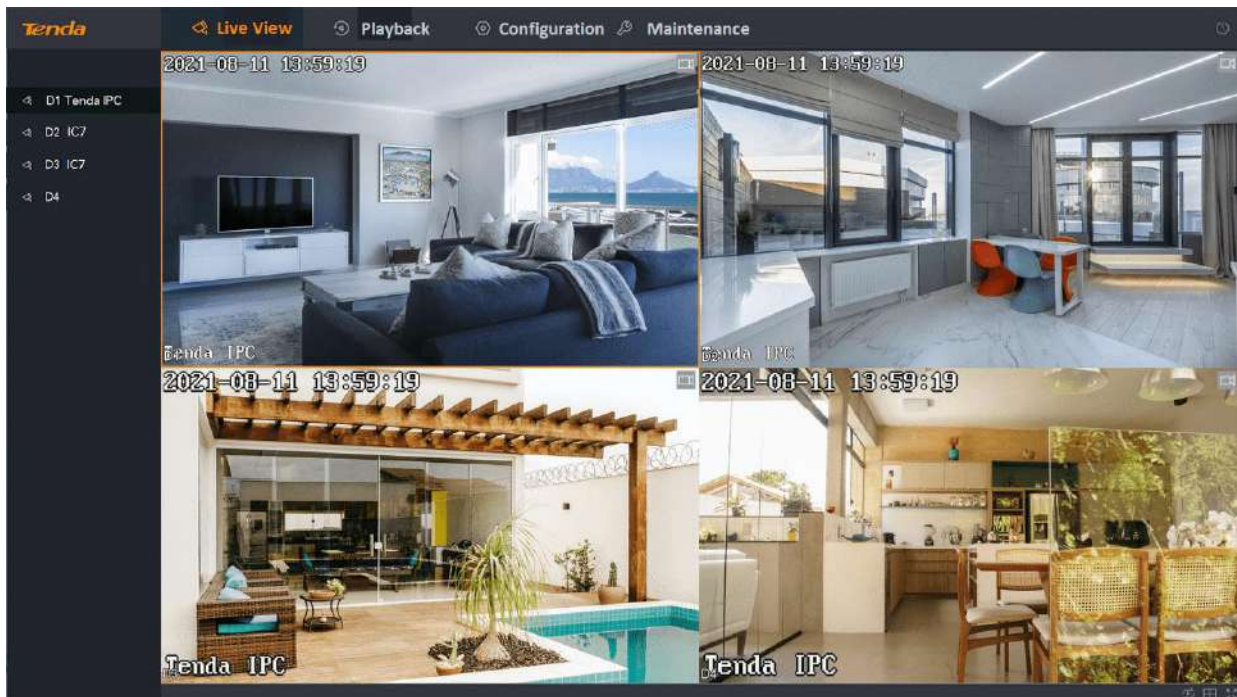



Click **Live View** to enter the page.





The default page is the live view page after you enter the GUI of the NVR. The number of window divisions of devices varies with different models. The actual model prevails. In this section, you can:

- Check Monitoring Image of All Channels
- [Quickly Add a Camera](#)
- [Instant Playback](#)
- [Zoom in the Target Area](#)
- [Switch Window Division Mode](#)
- [PTZ Control](#)
- [Check Stream Info](#)
- [Modify Channel Sequence](#)



Parameter description

Parameter	Description
	Instant playback. It is used to play back the recordings of the channel 5 minutes before the current time.
	Audio switch. By default, it is mute. On the bottom of the channel. You can turn on, turn off or adjust the volume of the audio.
	PTZ control. Only cameras that support PTZ can be edited. It is used to perform such related operations as adjusting the monitoring direction and speed and setting preset for the PTZ camera. Please refer to PTZ Control for more details.
	Stream info. Click it to check the current stream info, including stream type, resolution, frame rate and bitrate.
	On the upper-right corner of the channel. It specifies the audio of the video is enabled.
	Alarm. Once the motion detection function is enabled, if the camera detects movement or a human figure, this icon will be shown on the upper-right of the channel monitoring image.
	Recording. When the channel is recording, this icon will be shown on the upper-right of channel monitoring image.
	Previous Screen. Switch to the previous screen.
	Next Screen. Switch to the next screen.
	On the lower-left of the page. It specifies the usage of input bandwidth.

Parameter	Description
	Start or stop auto-switch live view. The system displays preview images in cycles from left to right and up to down according to the channel position. The auto-switch dwell time is 5 seconds by default, and you can modify it on the Live View Configuration page.
	Live view division mode. It specifies that the number of windows varies with the division modes.
	Fullscreen. It specifies that the live view page is displayed on full screen.
	It is used to add the camera.
	It specifies the current user account does not have the live view permission for this channel.

4.4.2 Quick Operation

Right-click the mouse on the live view page to perform a quick operation, such as window division, auto-switch, adding the camera, playback and fullscreen.

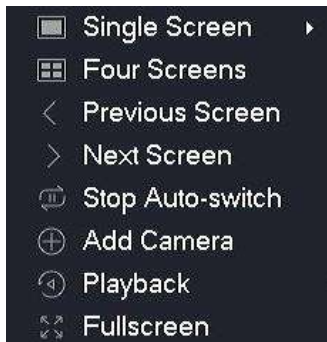

Parameter description

Parameter	Description
Single Screen	It is used to display single-channel images.
Four Screens	It is used to display four-channel images.
Multiple Screens	It is used to display multiple channel images. Available in NVR with more than 4 channels.
Previous Screen	They are used to switch to the previous or next screen.

Parameter	Description
Next Screen	
Start Auto-switch	They are used to start or stop the auto switch of the camera monitoring image.
Stop Auto-switch	
Add Camera	Click it to enter the addition camera page.
Playback	Click it to enter the playback page.
Fullscreen	They are used to display the live view page in fullscreen or exit fullscreen.
Exit Fullscreen	

4.4.3 Quickly Add a Camera



- If you want to add other brand cameras, please connect the camera to the LAN where the NVR is located using an Ethernet cable.
- If it is a camera in the video security kit, the camera can be discovered and added automatically within 2 minutes after the NVR is started. After the NVR is working properly, the camera can be discovered automatically, but you need to add the camera manually.
- If the camera is connected to the PoE port of the NVR, the camera will be discovered and added by the system within 2 minutes.
- The number of cameras that can be added for different models of NVR is different. Please add the camera according to the actual situation.

Method 1

Step 1 Connect the camera to the LAN where the NVR is located. If the Wi-Fi camera is included in the video security kit, place the camera within the coverage range of the NVR.

Step 2 Click **Live View**, right-click and select **Add Camera**.

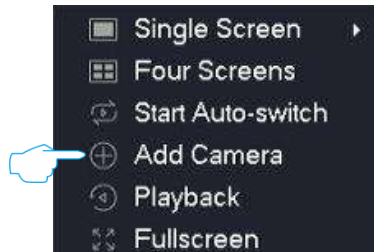

Step 3 Add the camera on the **Online Camera** module.

Method 1: Locate the camera you want to add according to the serial number (S/N), tick the box before it, and click **Add**.



If the user name and password of the camera to be added are different from the NVR, please add the camera by [Method 2](#).



Method 2:

1. Locate the camera you want to add according to the S/N, and click ⊕ behind the camera.



2. Select the protocol of the camera, enter the port, username and password, and click **Add**.

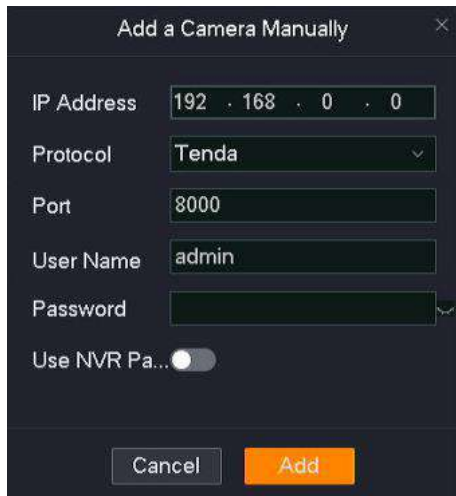

Dialog box titled "Add a Camera Manually" with the following fields:

- IP Address: 192 . 168 . 0 . 0
- Protocol: Tenda
- Port: 8000
- User Name: admin
- Password: (empty)
- Use NVR Pa...:

Buttons: Cancel, Add

3. If you want to add other cameras, repeat step 1 and step 2.

---End

Wait a moment. The camera is added successfully. You can check the added camera in the **Added Camera** module.

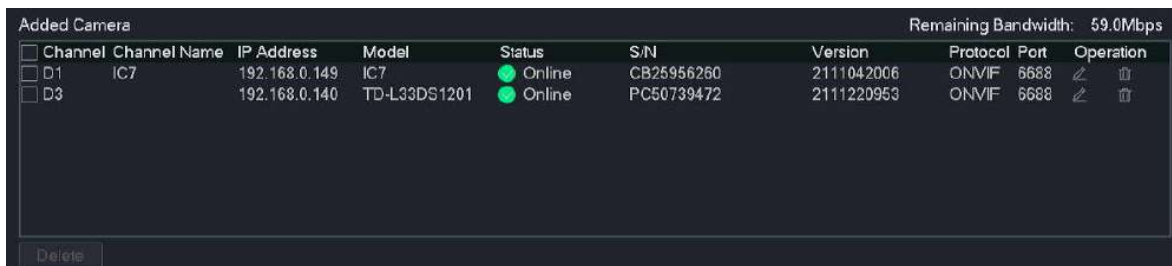

Channel	Channel Name	IP Address	Model	Status	S/N	Version	Protocol	Port	Operation
<input type="checkbox"/> D1	IC7	192.168.0.149	IC7	Online	CB25956260	2111042006	ONVIF	6688	
<input type="checkbox"/> D3		192.168.0.140	TD-L33DS1201	Online	PC50739472	2111220953	ONVIF	6688	

Remaining Bandwidth: 59.0Mbps

Delete



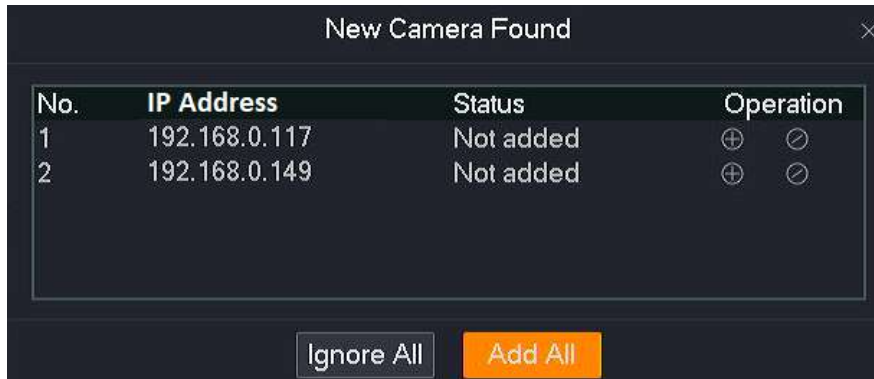

Method 2

- Step 1** Connect the camera to the LAN where the NVR is located. Place the Wi-Fi camera in the video security kit within the coverage range of the NVR.
- Step 2** Click **Live View**.
- Step 3** In the **New Camera Found** pop-up window, you can find the camera you want to add, and then click  in order or click **Add All** directly.



---End

Wait a moment until the camera is added successfully. You can view the added cameras in the **Added Camera** module on the **Configuration > Channel > Camera** page.

Added Camera										Remaining Bandwidth: 59.0Mbps	
<input type="checkbox"/>	Channel	Channel Name	IP Address	Model	Status	S/N	Version	Protocol	Port	Operation	
<input type="checkbox"/>	D1	IC7	192.168.0.149	IC7	● Online	CB25956260	2111042006	ONVIF	6688	 	
<input type="checkbox"/>	D3		192.168.0.140	TD-L33DS1201	● Online	PC50739472	2111220953	ONVIF	6688	 	

4.4.4 Instant Playback

Instant Playback enables you to view the recording files of the channel 5 minutes before the current time.



During instant playing back, other operations are not available on the live view page.

Procedures:

Step 1 [Log in to the GUI of the NVR.](#)

Step 2 Click **Live View**, hover the mouse over the channel you want to play back, and click  on the bottom of the channel.



Step 3 You can pause or play, control the playback time and exit as required.

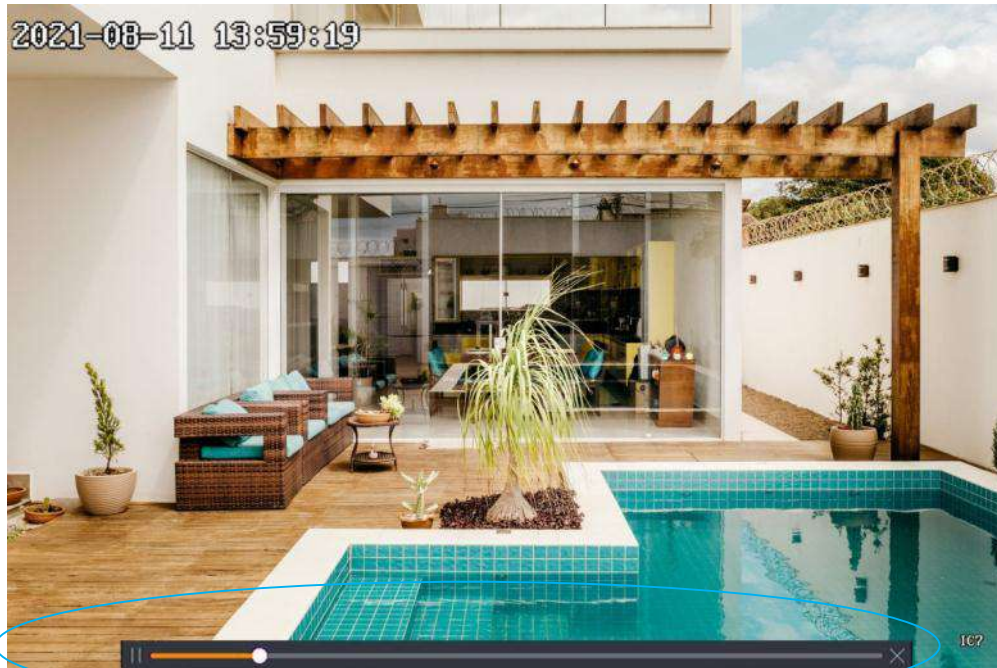

---End

4.4.5 Zoom in

The zoom-in function enables you to zoom in the target area of the monitoring image to view the detailed image.

Procedures:

- Step 1** [Log in to the GUI of the NVR.](#)
- Step 2** Click **Live View**.
- Step 3** Right-click the channel and select single screen or double-click the channel image to display the channel you want to zoom in.
- Step 4** Scroll up or down the mouse to zoom in on the target area, and you can view the details of the area. Left-click to cancel the zoom-in.

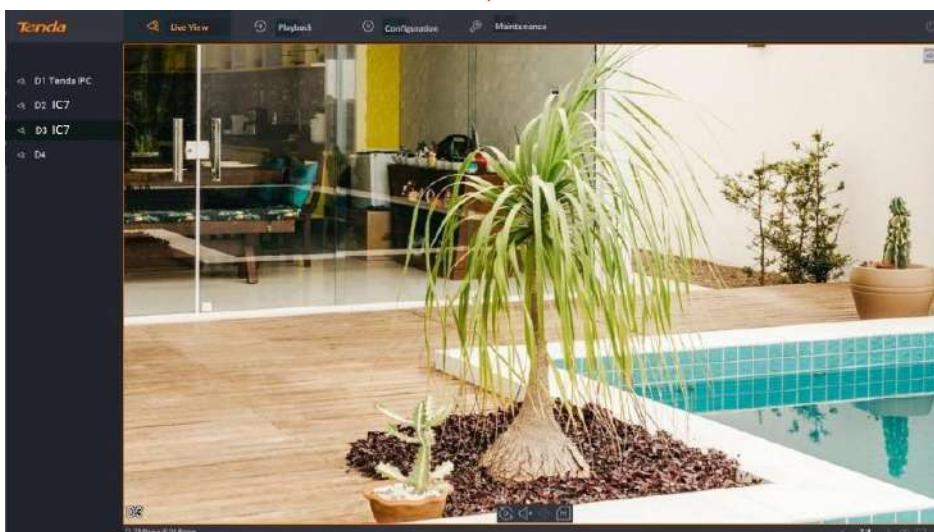

---End

4.4.6 Switch Window Division Mode

Different window division modes correspond to different numbers of window divisions. Tenda NVR supports single-screen and window divisions.

Method 1

Step 1 [Log in to the GUI of the NVR.](#)

Step 2 Click **Live View**.

Step 3 Right-click to select **Single Screen** and the channel to be displayed on the single-screen, or choose **Four Screens** (For the NVR with more than 4 channels, please select window division and window division mode.).

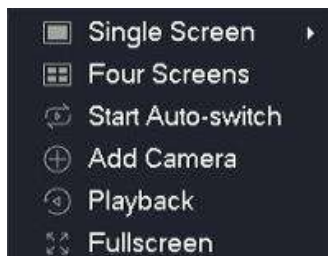

---End

Method 2

Live view with four screens is used for illustration here.

Step 1 [Log in to the GUI of the NVR.](#)

Step 2 Click **Live View**.

Step 3 Click **Window Division** () in the lower-right corner, then choose the window division mode as required.

---End

4.4.7 PTZ Control





Overview



PTZ indicates that a mechanical platform is composed of motors, which can realize horizontal and vertical movement. Through the control system, the direction and speed of the PTZ camera or speed dome camera can be remotely controlled.

On the live view page, you can control the PTZ camera or speed dome camera, including adjusting the monitoring direction and speed and setting the patrol.



Parameter & Button description

Parameter	Description
	It is used to control the PTZ direction. The direction (up, down, left, right, upper left, lower left, upper right and lower right) of the PTZ and speed dome camera can be controlled and the PTZ camera or speed dome camera horizontal 360° automatic patrol () can be set.
	It is used to reduce the multiple of the focal length change of the zoom lens. After clicking, the lens zooms out and the scene becomes smaller.
	It is used to increase the multiple of the focal length change of the zoom lens. After clicking, the lens zooms in and the scene becomes clearer.

Parameter	Description
	It is used to reduce the focal length of the zoom lens. After clicking, the distant scene becomes clear, and the nearby scene gradually becomes blurred.
	It is used to increase the focal length of the zoom lens. After clicking, the nearby scene becomes clear, and the distant scene gradually becomes blurred.
	Aperture-. Click it to reduce luminous flux.
	Aperture+. Click it to increase luminous flux.
Speed	It specifies the speed of the camera PTZ, the larger the value, the faster the speed.
	No. It specifies the number of preset.
	Name It specifies the name of the preset.
Preset	It is used to perform operations for the preset: Click  to use the currently adjusted monitoring direction and zoom as the parameters of the preset. Click  to call the preset, control the PTZ camera to rotate to the monitoring position of the preset and apply the zoom of the preset. Click  to delete the preset.
	No. It specifies the number of the patrol.
	Name It specifies the name of the patrol.
Patrol	It is used to perform operations for the patrol: Click  to set preset for this patrol. Click  to start patrol according to the added preset. Only one path can be patrolled at a time. Click  to stop patrol.

Set Preset

Set the monitoring direction for a specific preset.

Procedures:

Step 1 [Log in to the GUI of the NVR.](#)

Step 2 Click **Live View**, hover the mouse over the PTZ camera or dome channel you want to set preset, and click the PTZ control icon  at the bottom of the channel.

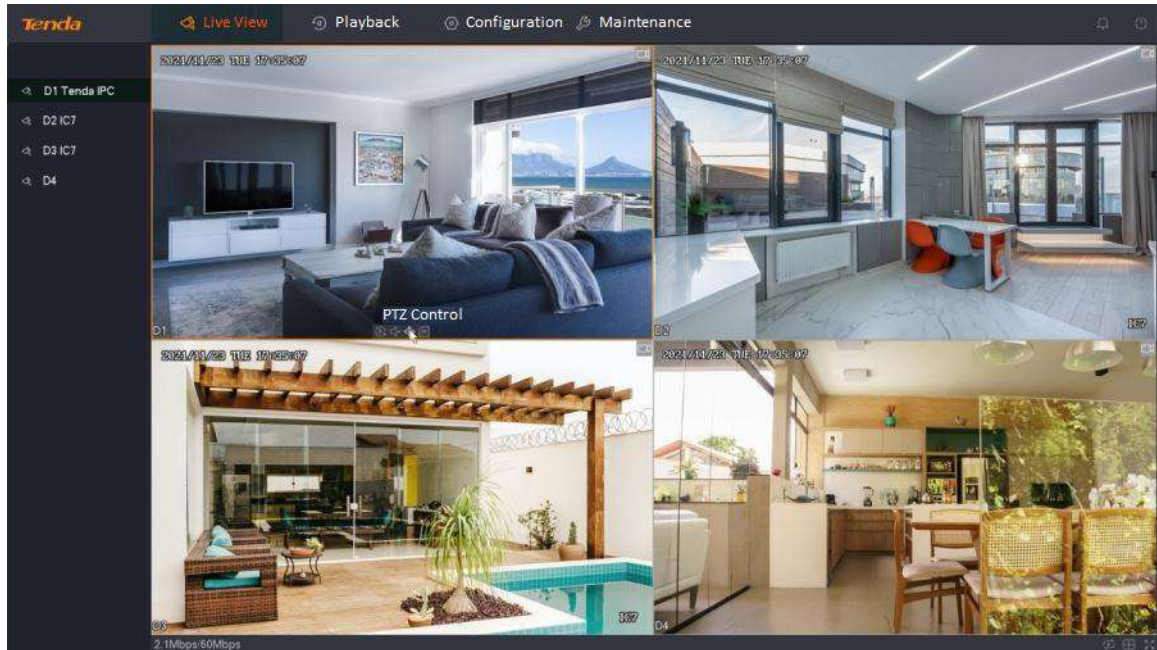

Step 3 Use the arrow keys to control the camera to rotate to the desired monitoring position.

Step 4 Click **Preset** tab, target the preset to which this monitoring direction is to be applied, and click .

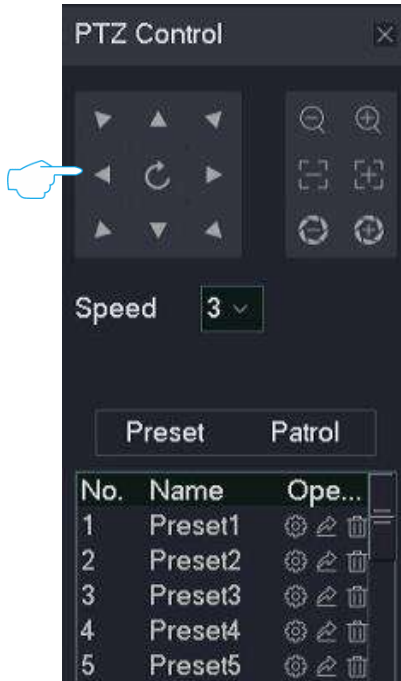

---End

Set Patrol

Add the preset for a specific patrol.

Procedures:

Step 1 [Log in to the GUI of the NVR.](#)

Step 2 Refer to [Set Preset](#) to add other preset.

Step 3 Set patrol.

1. Click **Patrol** tab.
2. Target the patrol you want to set and click , which is **Patrol 1** in this example.

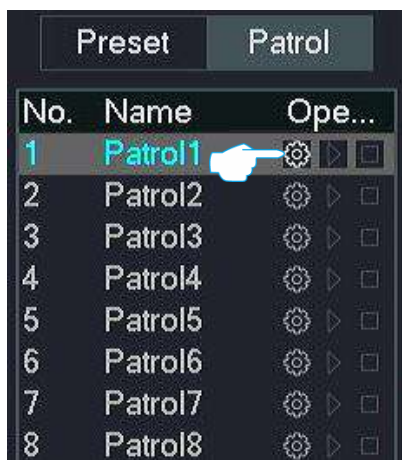

3. Click **Add**.

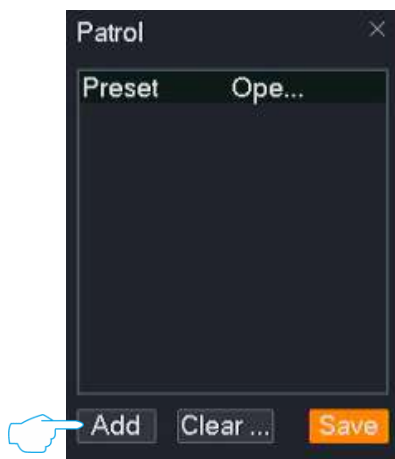

4. Select the preset you added, set PTZ speed and the dwell time to reach the preset, and click **OK**.

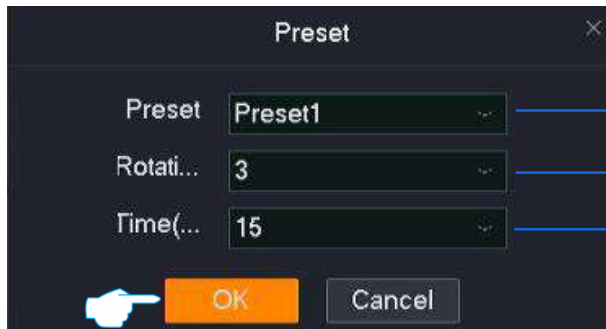

It specifies the preset used by the patrol need to be added in advance.

It specifies the speed of running to the preset

It specifies the dwell time after running to the preset

5. Refer to step 4 to add the other preset and click **Save**.



It specifies the preset of the patrol application

- Click to re-edit the used preset
- Click to move the preset up one position. Unavailable in the first preset
- Click to move the preset down one position. Unavailable in the last preset
- Click to delete the corresponding preset



After the patrol parameters are adjusted, click **Save** to take effect.

---End

Call Preset

Control the camera to rotate to the monitoring position of the specific preset.



Before the preset is called, you need to [Set the Preset](#) first.

Procedures:

Step 1 [Log in to the GUI of the NVR.](#)

Step 2 Click **Live View**, hover the mouse over the camera channel you want to perform PTZ control, and click  at the bottom of the channel.

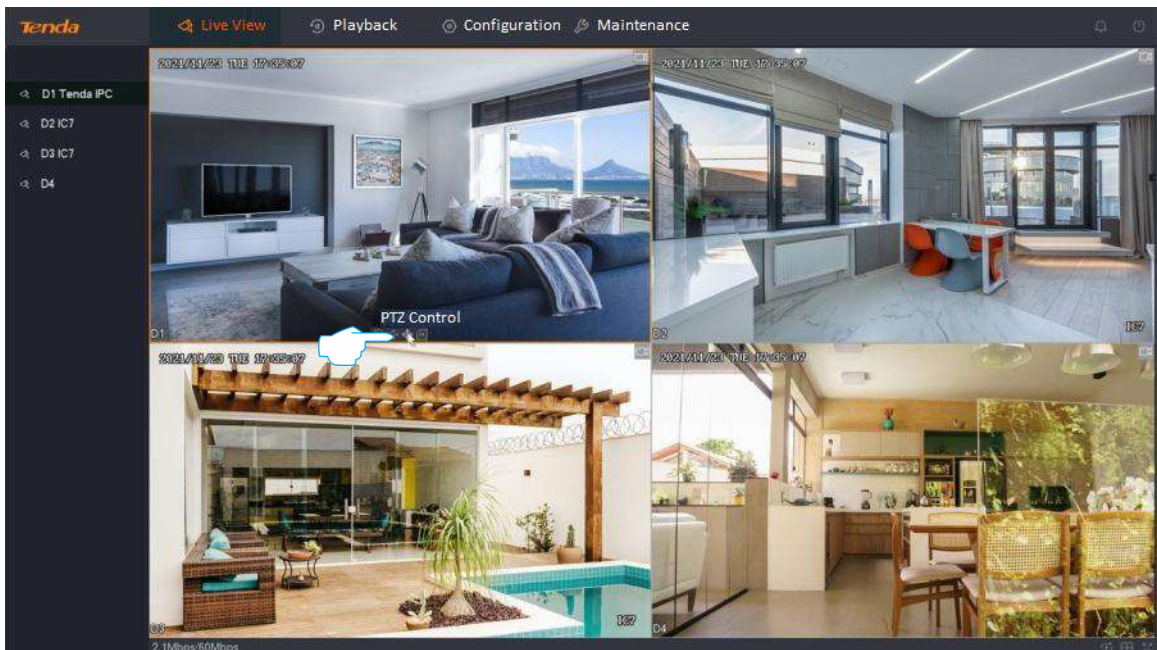

Step 3 Click **Preset** tab, target the preset you want to call, and then click  .

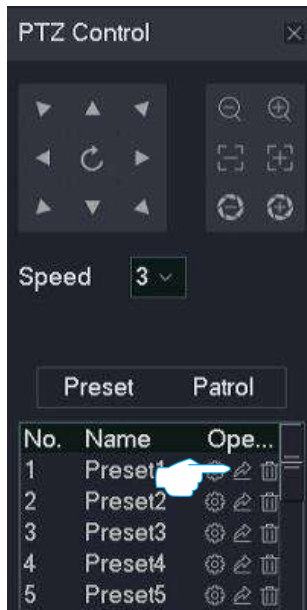

---End

The camera will rotate to the monitoring position of this preset.

Call Patrol

Control the camera patrols according to the specified track.



- Before the patrol is called, you can [Set the Preset](#) for this patrol first.
- Only one patrol can be called at the same time.

Procedures:

Step 1 [Log in to the GUI of the NVR.](#)

Step 2 Click **Live View**, hover the mouse over the camera channel you want to perform PTZ control, and click  at the bottom of the channel.

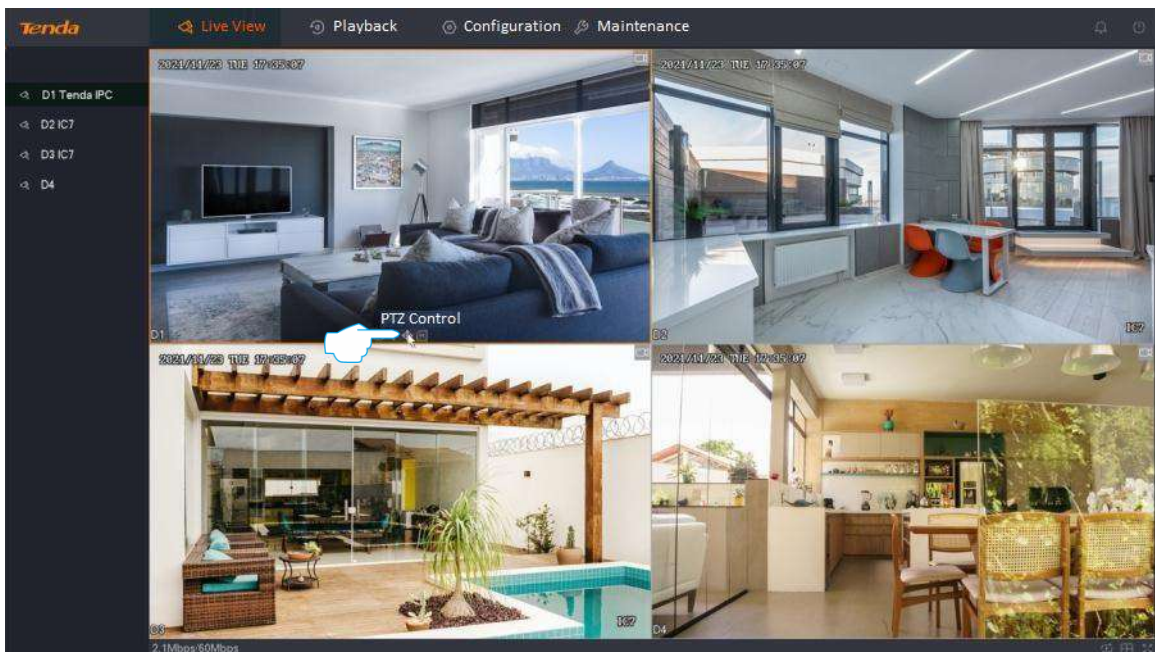

Step 3 Click **Patrol** tab, target the patrol you want to call, and then click .

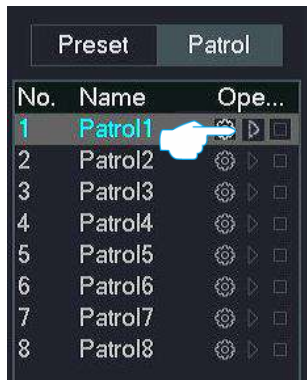

---End

The camera will automatically patrol in sequence according to the preset that have been added to the patrol. Click to stop patrol.

Set Camera Horizontal 360° Patrol

Control the camera to perform a horizontal 360° rotating patrol at the current position.

Procedures:

Step 1 [Log in to the GUI of the NVR.](#)

Step 2 Click **Live View**, hover the mouse over the camera channel you want to perform PTZ control, and click  at the bottom of the channel.

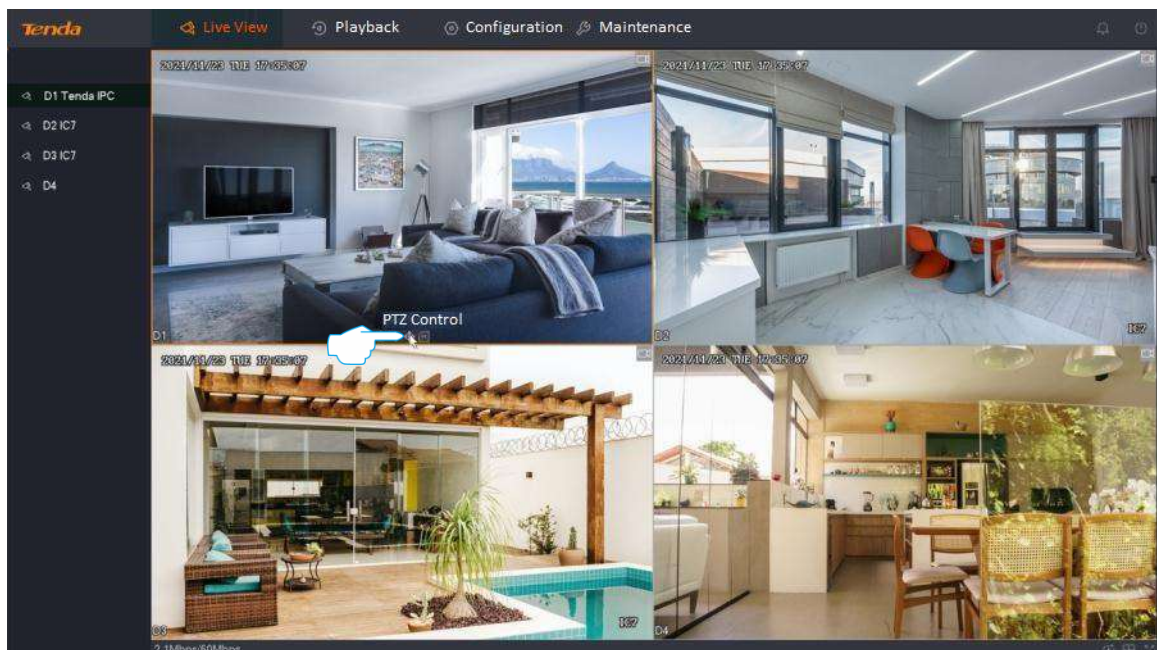

Step 3 Click .

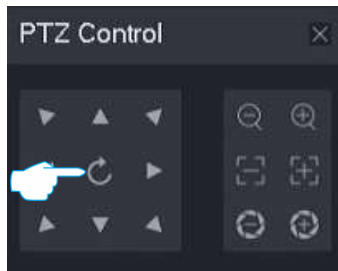

---End

The camera will perform a horizontal 360° rotating patrol at the current position until you click  again to stop the patrol.

4.4.8 Check Stream Info

You can check such real-time stream information as resolution, frame rate and bitrate of the channel as required on the live view page.

Procedures:

Step 1 [Log in to the GUI of the NVR.](#)

Step 2 Click **Live View**.

Step 3 Hover the mouse over the channel you want to check the stream information, and click  at the bottom of the channel.

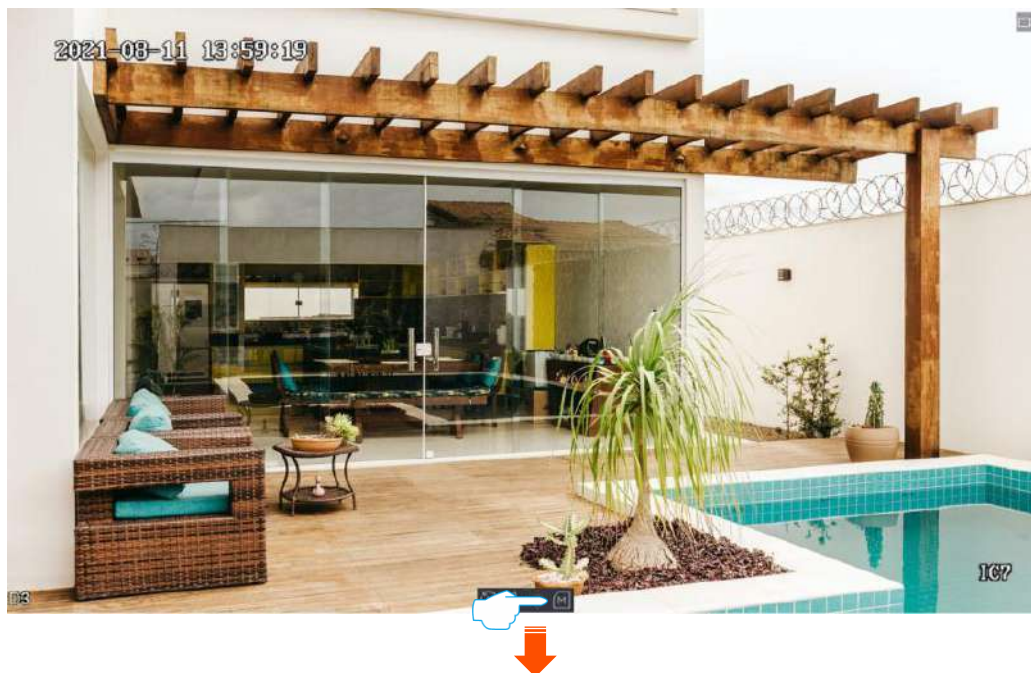



---End

4.4.9 Modify Channel Sequence

You can adjust the display sequence of each channel on the live view page as required.

Procedures:

Step 1 [Log in to the GUI of the NVR.](#)

Step 2 Click **Live View** to ensure that the current live view mode is window division mode. If not, please set the live view mode to window division mode first. Refer to [Switch Window Division Mode](#) for detailed steps.

Step 3 Select the channel you want to adjust the live view position, hold down the left button on your mouse and drag it to another live view screen position, then release the mouse.

---End

The display positions of the two channels have been exchanged successfully.

4.5 Playback

On the playback page, you can play back or export recording files according to the search conditions. The NVR supports channel playback, file playback and tag playback.

4.5.1 Channel Playback









Overview















Navigate to **Playback > Channel**.

Channel playback indicates that you can search and play back the corresponding recording files according to the channel and date. You can check, tag, clip and export the recording files as required.



Parameter description

Parameter	Description
	Channel selection shortcut button. It is used to quickly select single or multiple channels. The selected channel will be displayed on the live view page on the right.
Select channel	Channel quick selection. It is used to quickly select a target channel after a channel is selected through the channel selection shortcut button . The selected channel will be displayed on the live view page on the right.
D1 - D4	Channel number. If you want to play back the recording of a target channel, tick the channel number. The selected channel will be displayed on the live view page on the right.
Select date	 Previous year. Click it to enter the previous year of the currently displayed year.
	 Previous month. Click it to enter the previous month of the currently displayed month.
	 Next month. Click it to enter the next month of the currently displayed month.
	 Next year. Click it to enter the next year of the currently displayed year.
	 An orange triangle icon on the upper-right of the date indicates that there is a recording.
	 The date in orange shading indicates the currently selected date.
 The date with an orange frame indicates the date of the current system time.	
Time bar	It specifies the recording type and time under the current filter conditions. <ul style="list-style-type: none"> — Click any position in the color area on the time bar to play back from here. — The time bar color varies with recoding file types. Green means normal recording and red means alarm recording.  Up to 4 channels can be displayed. If you select more than 4 channels, only the currently selected channel will be displayed.

Parameter	Description
Time granularity of time bar	 <p>It specifies the time unit on the time bar. The default time is 24 hours. The smaller the time unit, the larger the time scale. The time unit can be adjusted by the mouse wheel.</p>
	 <p>Previous period. It is used to switch the period to the previous period according to the current time granularity.</p>
	 <p>Next period. It is used to switch the period to the next period according to the current time granularity.</p>
Playback control area	 <p>It is used to tag a recording. Click it to set a tag for the recording at a certain moment. It is convenient for users to search for recording files according to the tag field.</p>
	 <p>Click it to clip recording files.</p>
	 <p>Click it to export clipped recording files to a USB storage device.</p>
	 <p>Click it to mute or unmute the recording file audio. By default, the recording is mute.</p>
	 <p>Slow down. Click it to switch to slow down mode.</p>
	 <p>It specifies the multiplier of the playback speed.</p>
	 <p>Speed up. Click it to increase the video playback speed and switch to speed-up mode.</p>
	 <p>Click it to play or pause recording files.</p>
	 <p>Click it to go back 30 seconds.</p>
	 <p>Click it to forward 30 seconds.</p>
 <p>It specifies the ordinary recording files.</p>	
 <p>It specifies the alarm recording file.</p>	

Parameter	Description
	Click it to display in full-screen.

Play Back the Recordings of the Target Channel

Assume that you want to play back the recordings of D1 to D4 on October 30, 2021.

Procedures:

Step 1 [Log in to the GUI of the NVR.](#)

Step 2 Navigate to **Playback > Channel**.

Step 3 Click .

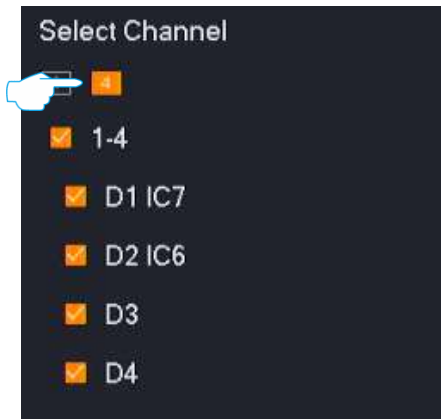

Step 4 Select date, which is **October 30, 2021**, in this example.

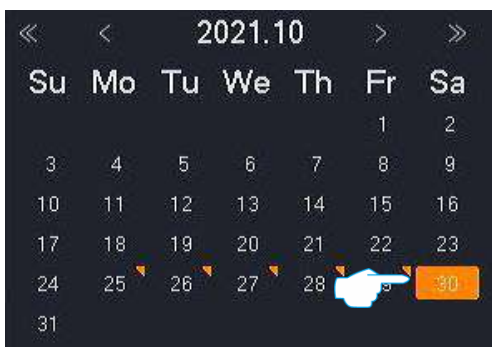

Step 5 Edit the time bar and playback control area to play back the recordings as required.

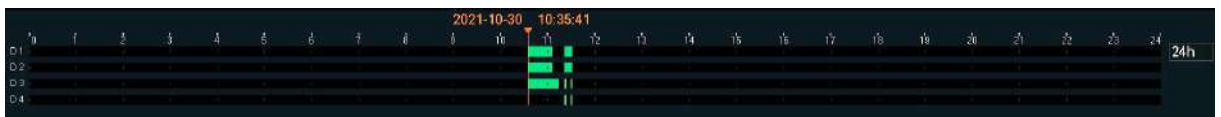

---End

4.5.2 File Playback

Overview

Navigate to **Playback > File**.

File playback indicates that you can check the recording files of the channel in a specific period according to the file type (including normal, alarm and all). You can check, export, tag, clip and export the recording files as required.

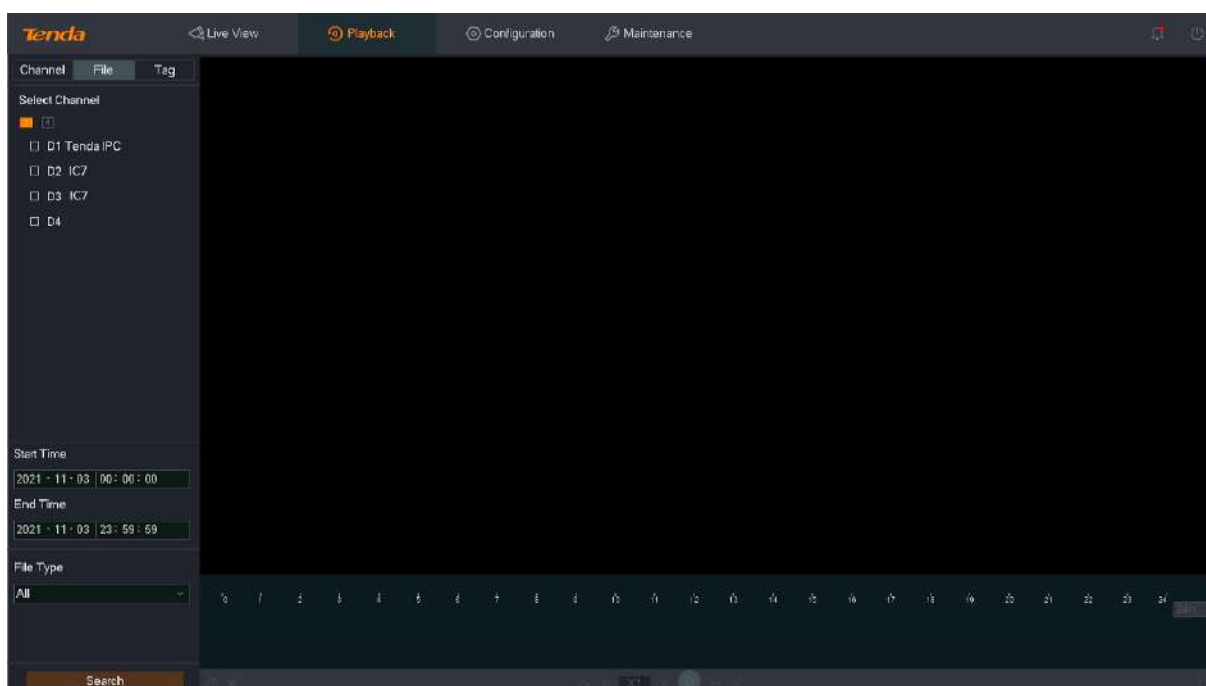

Parameter description

Parameter	Description
<div style="display: flex; align-items: center; gap: 10px;"> <div style="border: 1px solid gray; padding: 2px 5px;">1</div>, <div style="border: 1px solid gray; padding: 2px 5px;">4</div>, <div style="border: 1px solid gray; padding: 2px 5px;">8</div> </div>	<p>Channel selection shortcut button.</p> <p>It is used to quickly select single or multiple channels. The selected channel will be displayed on the live view page on the right.</p>
Select channel	<p>Channel quick selection.</p> <p>It is used to quickly select a target channel after a channel is selected through the channel selection shortcut button. The selected channel will be displayed on the live view page on the right.</p>
D1 - D4	<p>Channel number.</p> <p>Tick the channel number to play back the recording of a target channel. The selected channel will be displayed on the live view page on the right.</p>

Parameter	Description	
Start time	/	
End time	/	
File type	Normal	It specifies the recording file is a normal recording.
	Alarm	It specifies the recording file is an alarm recording.
	All	It specifies the recording file contains normal recording and alarm recording.



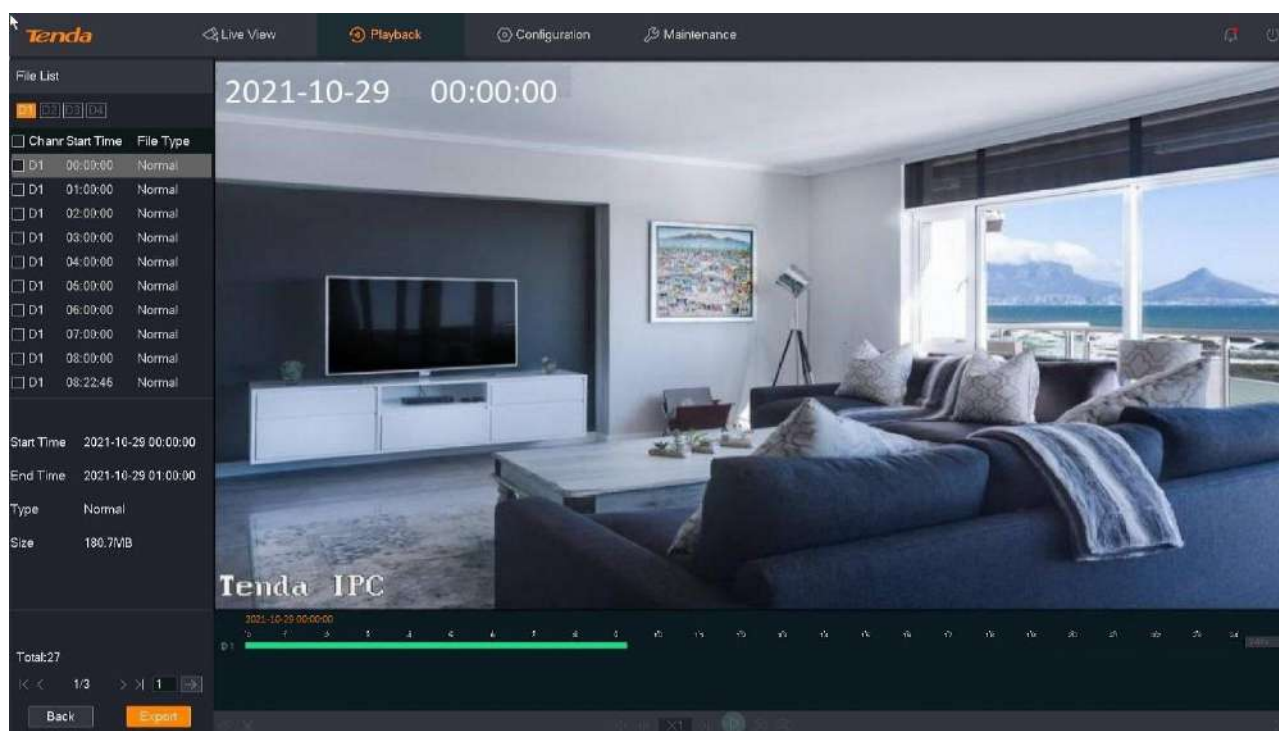





After the channel, time, and file type are configured, you can search for the recording files. Double-click the recording file to play back, and you can edit it according to the actual situation.



Some parameter description

Refer to [parameter description of channel playback](#) for other parameters description.

Parameter	Description
File List	It specifies the recording file searched according to conditions.
D1 - D4	It specifies the channel number. Click a specific channel number to filter the recording files of the channel.

Parameter	Description
Channel	It specifies the channel to which the recording file belongs.
Start time	It specifies the start time of the recording file.
File type	It specifies the type of the recording file, including normal and alarm.
Start time	It specifies the start date and time of the currently selected recording file. The first recording file is selected by default.
End time	It specifies the end date and time of the currently selected recording file. The first recording file is selected by default.
Type	It specifies the type of the currently selected recording file. The first recording file is selected by default.
Size	It specifies the size of the currently selected recording file. The first recording file is selected by default.
	Home page. Click it to redirect to the home page of the file list.
	Previous page. Click it to redirect to the previous page of the current file list.
	Next page. Click it to redirect to the next page of the current file list.
	Last page. Click it to redirect to the last page of the file list.
	Specific page. Click it to redirect to the specific page of the file list.
	Click it to go back to the File Playback page.
	Click it to export the selected recording file.
	TIP Only one page of recording files can be exported at a time.

Play Back Normal or Alarm Recording

Assume that you want to check and play back all recordings of D1 from 00:00:00 to 23:59:59 on October 29, 2021.

Procedures:

Step 1 [Log in to the GUI of the NVR.](#)

Step 2 Navigate to **Playback > File.**

Step 3 Tick D1.

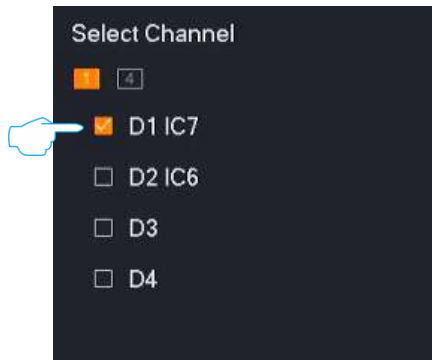

Step 4 Select time, which is **00:00:00** to **23:59:59** on **October 29, 2021**, in this example.

Step 5 Select the file type, which is **All** in this example.

Step 6 Click **Search**.

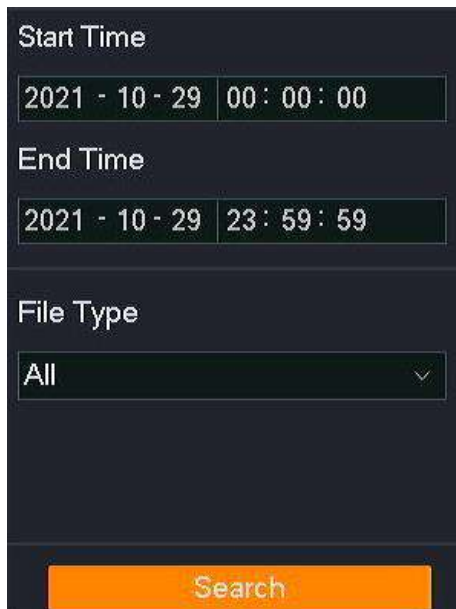

Step 7 Searched successfully. You can double-click the recording file to view the recording file in the live view window on the right and edit it as required.

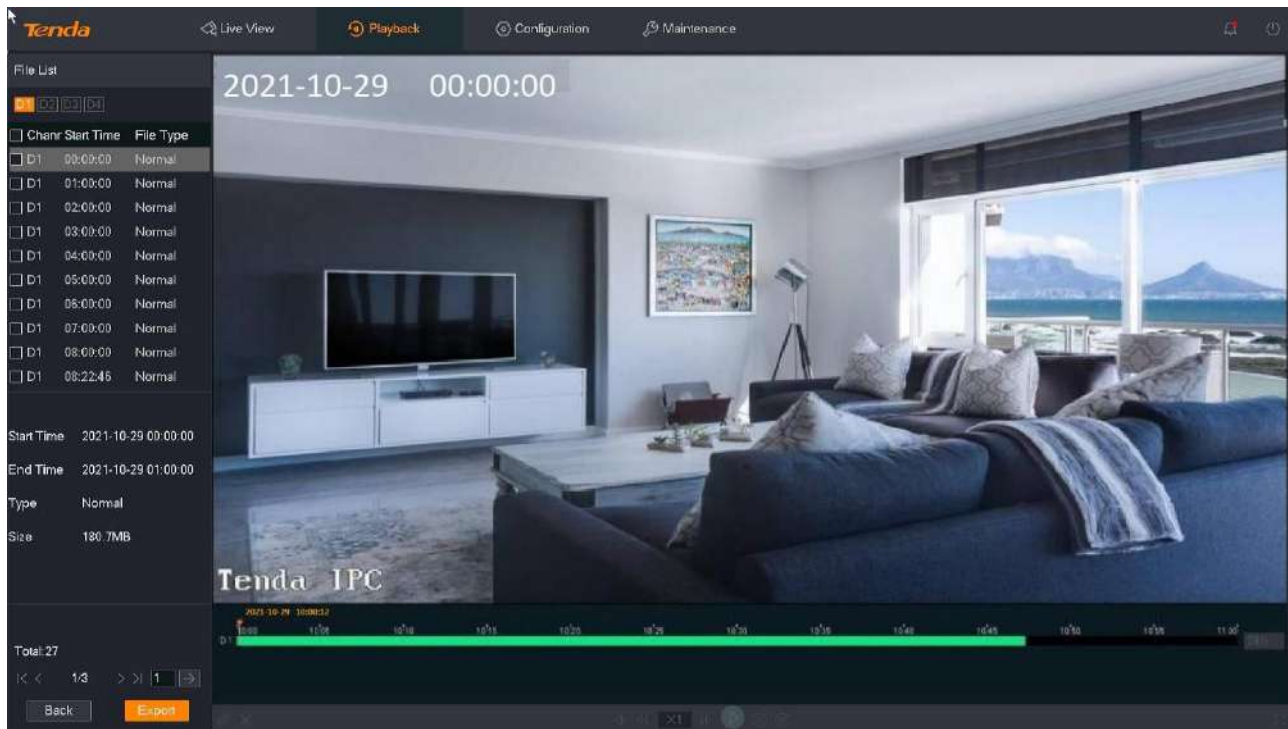

---End

Export Recording File

Assume that you want to export all recordings of D3 from 00:00:00 to 23:59:59 on October 29, 2021.



TIP

The NVR can only recognize USB storage devices formatted as FAT32 for now.

Method 1

It is applicable for the NVR that cannot be connected to the mouse and the USB storage device at the same time.

Step 1 [Log in to the GUI of the NVR.](#)

Step 2 Navigate to **Playback > File**, and tick **D3**.

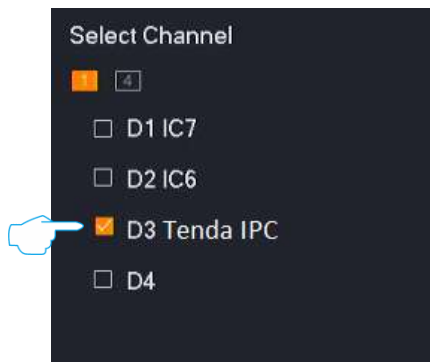

Step 3 Select time, which is **00:00:00** to **23:59:59** on **October 29, 2021**.

Step 4 Select the file type, which is **Alarm** in this example, then click **Search**.

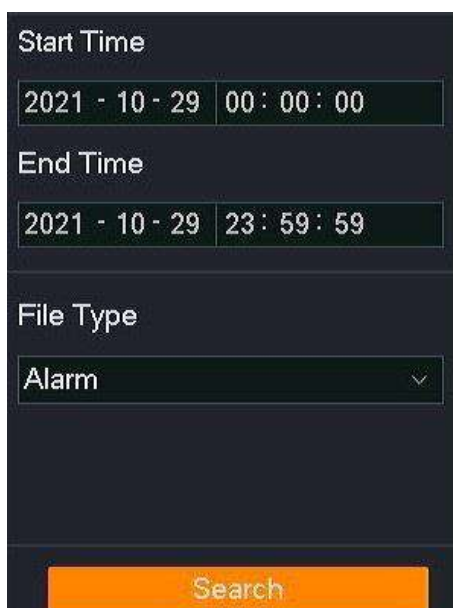

Step 5 Select all alarm recording files on the current page, then click **Export**.



Only one page of recording files can be exported at a time.

File List

D1 D2 D3 D4

<input type="checkbox"/>	Chanr	Start Time	File Type
<input type="checkbox"/>	D3	15:36:28	Alarm
<input type="checkbox"/>	D3	15:36:53	Alarm
<input type="checkbox"/>	D3	15:37:26	Alarm
<input type="checkbox"/>	D3	15:39:33	Alarm
<input type="checkbox"/>	D3	15:51:16	Alarm

Start Time 2021-10-30 15:36:28

End Time 2021-10-30 15:36:42

Type Alarm

Size 0.9MB

Total:5

<< < 1/1 > >> 1 →

- Step 6** Unplug the mouse and connect the USB storage device to the USB port of the NVR within 1 minute.



---End

The recording files with the suffix of .mp4 (R means normal recording, M means alarm recording) will be exported to the root directory of the USB storage device.

Method 2

It is applicable for the NVR that can be connected to the mouse and the USB storage device at the same time.



If the NVR has only one USB port or the USB port has been used, you need to prepare a USB hub by yourself.

- Step 1** Connect the USB storage device to the USB port of the NVR.

- Step 2** [Log in to the GUI of the NVR.](#)

- Step 3** Navigate to **Playback > File**, and tick D3.

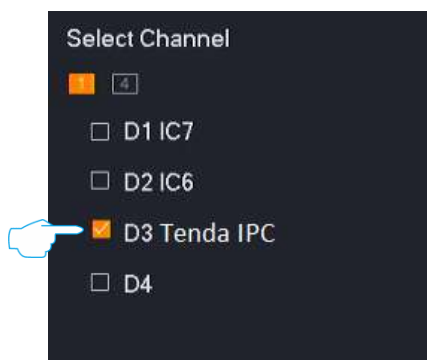

Step 4 Select time, which is **00:00:00** to **23:59:59** on **October 29, 2021**, in this example.

Step 5 Select the file type, which is **Alarm** in this example, then click **Search**.

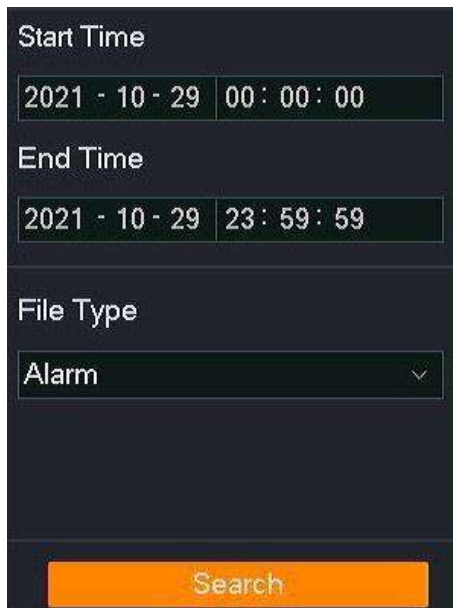

The image shows a dark-themed search filter interface. It contains the following elements:

- Start Time:** A text input field containing "2021 - 10 - 29" and a time selection field containing "00 : 00 : 00".
- End Time:** A text input field containing "2021 - 10 - 29" and a time selection field containing "23 : 59 : 59".
- File Type:** A dropdown menu with "Alarm" selected and a downward arrow icon.
- Search Button:** A prominent orange button with the text "Search" in white.

Step 6 Select all alarm recording files on the current page, then click **Export**.



Only one page of recording files can be exported at a time.

File List

D1 D2 D3 D4

<input type="checkbox"/>	Chanr	Start Time	File Type
<input type="checkbox"/>	D3	15:36:28	Alarm
<input type="checkbox"/>	D3	15:36:53	Alarm
<input type="checkbox"/>	D3	15:37:26	Alarm
<input type="checkbox"/>	D3	15:39:33	Alarm
<input type="checkbox"/>	D3	15:51:16	Alarm

Start Time 2021-10-30 15:36:28

End Time 2021-10-30 15:36:42

Type Alarm

Size 0.9MB

Total:5

<< < 1/1 > >> 1 →

Step 7 Select your USB storage device from the USB Device drop-down list box, then click **Export**.

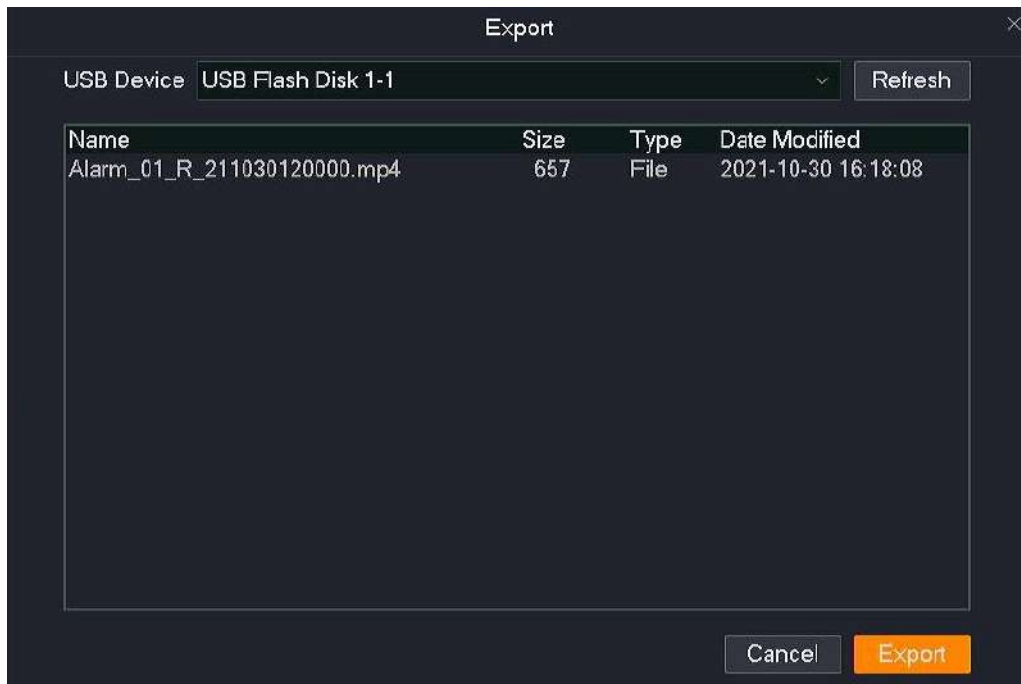

Step 8 After the files are exported successfully, if you want to continue to export the recording files on other pages, please redirect to the recording file on that page and repeat **Step 6** to **Step 7**.

---End

The recording files with the suffix of .mp4 (R means normal recording, M means alarm recording) will be exported to the root directory of the USB storage device.

4.5.3 Add Tag

Overview

Add tag refers to you can add a tag to the recording at a moment when the recording is played back, so that the recording file can be quickly located by the tag name. The system supports searching and positioning by tag keywords.

Add Tag for Channel Recording File

Assume that you found an alarm recording when you searched the recording file of D1 all day on October 30, 2021, and you want to add a tag to this recording.

Procedures:

- Step 1** [Log in to the GUI of the NVR.](#)
- Step 2** Navigate to **Playback > Channel.**
- Step 3** Tick **D1.**

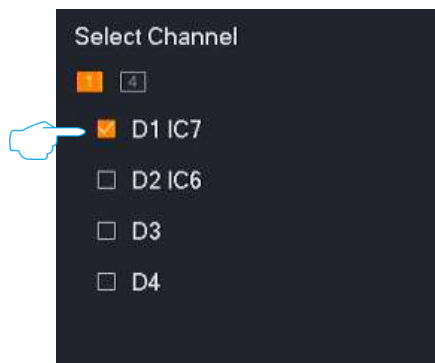

- Step 4** Select date, which is **October 30, 2021**, in this example.



Step 5 Left-click the time point you want to tag on the right time bar, then click  (tag) in the lower-left corner, the recording type is alarm recording in this example.

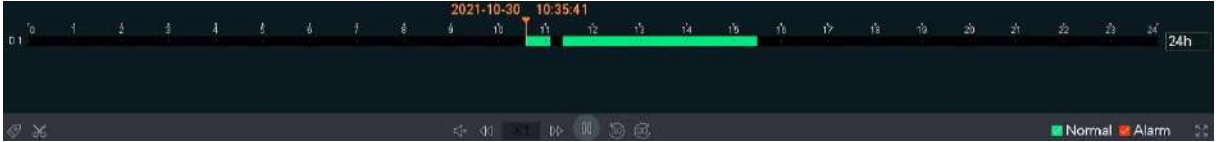

Step 6 Set the name of the tag, then click **Save**.

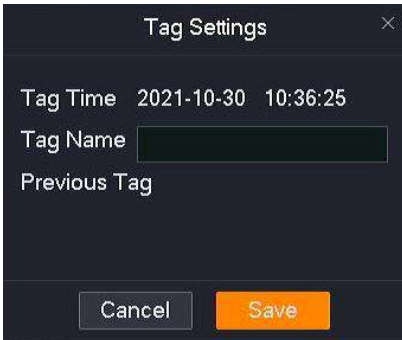

After the setting completes, you can search the recording file according to the tag name on the **Tag** page.

---End

Add Tag for the Searched Recording File

Assume that you want to add a tag to a target alarm recording when you are viewing the alarm recording files of D1 all day on October 30, 2021.

Procedures:

Step 1 [Log in to the GUI of the NVR.](#)

Step 2 Navigate to **Playback > File**.

Step 3 Tick D1.

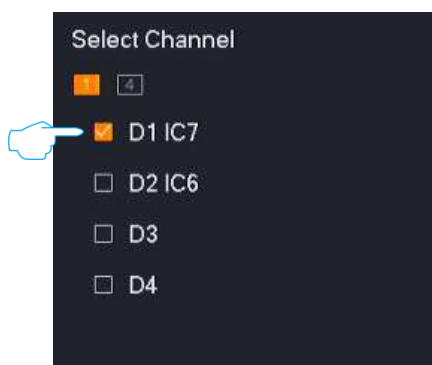

Step 4 Select time, which is **00:00:00** to **23:59:59** on **October 30, 2021**, in this example.

Step 5 Select the file type, which is **Alarm** in this example, then click **Search**.

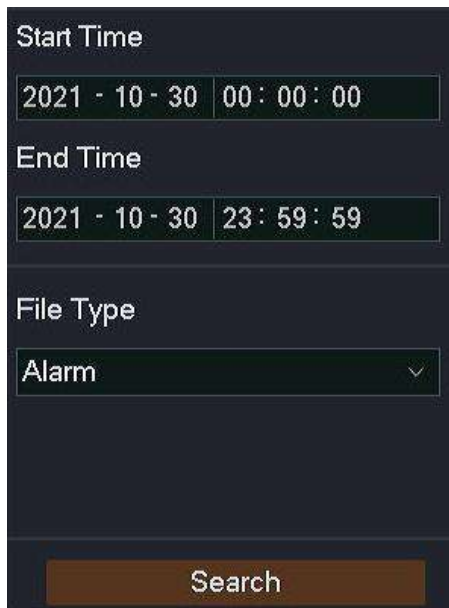

The screenshot shows a search form with three main sections: 'Start Time' with a date and time input field showing '2021 - 10 - 30' and '00 : 00 : 00'; 'End Time' with a date and time input field showing '2021 - 10 - 30' and '23 : 59 : 59'; and 'File Type' with a dropdown menu currently set to 'Alarm'. A 'Search' button is located at the bottom of the form.

Step 6 Double-click the recording file on the left to play back the recording file on the right, then click  (tag) in the lower-left corner.



Step 7 Set the name of the tag, then click **Save**.

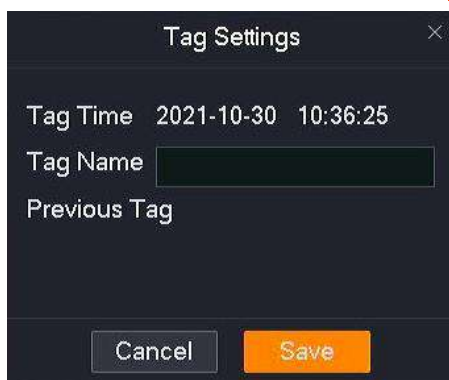

The screenshot shows a 'Tag Settings' dialog box. It contains the following fields: 'Tag Time' with the value '2021-10-30 10:36:25'; 'Tag Name' with an empty text input field; and 'Previous Tag' with an empty text input field. At the bottom, there are two buttons: 'Cancel' and 'Save'.

After the setting completes, you can search the recording file according to the tag name on the **Tag** page.

---End

4.5.4 Tag Playback

Overview

Navigate to **Playback > Tag**.

Tag playback refers to you can check the tagged recordings according to the channel, tag time and tag name. You can view, tag, clip and export the recording files as required.

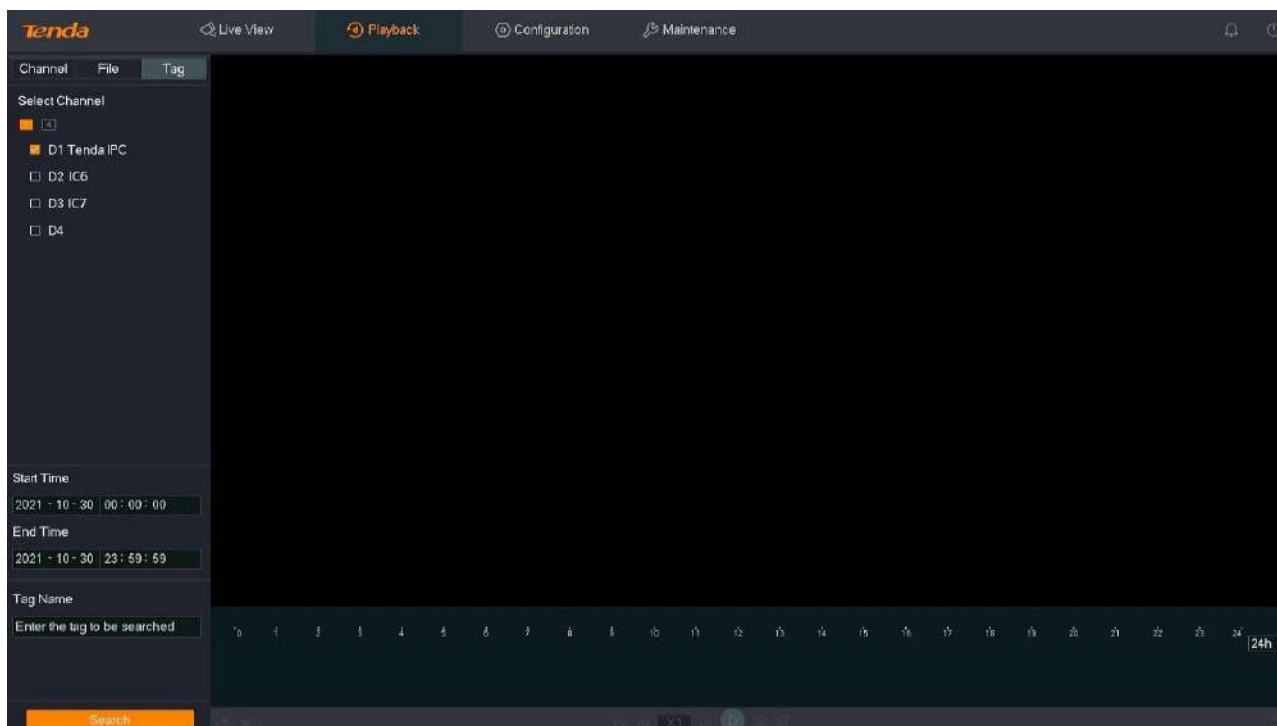

Parameter description

Parameter	Description
<div style="display: flex; align-items: center; gap: 10px;"> 1, 4, 8 </div>	<p>Channel selection shortcut button.</p> <p>It is used to quickly select single or multiple channels. The selected channel will be displayed on the live view page on the right.</p>
Select channel	<p>Channel quick selection.</p> <p>It is used to quickly select a target channel after a channel is selected through the channel selection shortcut button. The selected channel will be displayed on the live view page on the right.</p>
D1 - D4	<p>Channel number.</p> <p>If you want to play back the recording of a target channel, tick the channel number. The selected channel will be displayed on the live view page on the right.</p>

Parameter	Description
Start time /	They specify the start time and end time of the recording file.
End time /	
Tag name /	It specifies the tag name of the recording file.











After the channel, time, and tag name are configured, you can search for the recording files. Double-click the recording file to play back, and you can edit it according to the actual situation.



Some parameter description

Refer to [parameter description of channel playback](#) for other parameters description.

Parameter	Description
Tagged recording	It specifies the recording file searched according to conditions.
D1 - D4	Channel number. It specifies you can click a target channel number to filter the recording file of the channel.
Channel	It specifies the channel to which the recording file belongs.
Time	It specifies the time of tagging.

Parameter	Description
Name	It specifies the tag name of the recording file.
Operation	<p>It is used to perform operations for the recorded file:</p> <ul style="list-style-type: none"> – Click  to edit the tag name of the recording file. – Click  to delete the tag of the recording file.
	<p>Home page.</p> <p>Click it to redirect to the home page of the file list.</p>
	<p>Previous page.</p> <p>Click it to redirect to the previous page of the current file list.</p>
	<p>Next page.</p> <p>Click it to redirect to the next page of the current file list.</p>
	<p>Last page.</p> <p>Click it to redirect to the last page of the file list.</p>
	<p>Specific page.</p> <p>Click it to redirect to the specific page of the file list.</p>
	<p>Click it to go back to the file page.</p>
	<p>Click it to export the selected recording file.</p> <p> TIP</p> <p>Only one page of recording files can be exported at a time.</p>

Play Back Specific Tagged Recording

Assume that you want to check and play back the recording files whose tag name is **Human** in D1 to D4 on October 30, 2021.

Procedures:

Step 1 [Log in to the GUI of the NVR.](#)

Step 2 Navigate to **Playback > Tag**.

Step 3 Click 4.

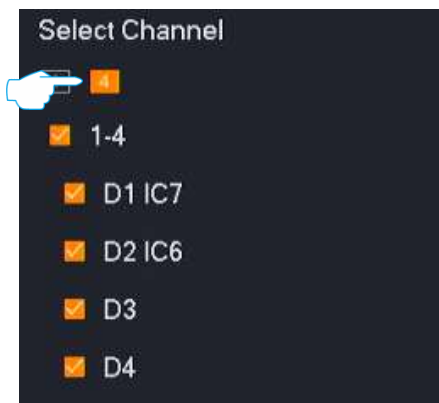

Step 4 Select time, which is **00:00:00** to **23:59:59** on **October 30, 2021**, in this example.

Step 5 Enter the tag name of the recording file you want to search in **Tag Name**, which is **Human** in this example.

Step 6 Click **Search**.



Step 7 After the search completes, you can double-click the recording file to view the recording file in the live view window on the right and edit it as required.

---End

Manage Tagged Recording

Modify Tag Name

Assume that you want to modify the tag name **Human** of the recording files in D1 to D4 on October 30, 2021, to **Human Detection**.

Procedures:

Step 1 [Log in to the GUI of the NVR.](#)

Step 2 Navigate to **Playback > Tag** and click .





Step 3 Select time, which is **00:00:00** to **23:59:59** on **October 30, 2021**, in this example.

Step 4 Enter the tag name of the recording file you want to search in **Tag Name**, which is **Human** in this example.

Step 5 Click **Search**.

Step 6 Select the channel number to filter the recording files that meet the conditions, and click  behind the recording file. Modify the tag name in the pop-up dialog window, which is **Human detection** in this example, and click **Save**.

Chan	Time	Name	Operatic
D1	10:36:52	Huma...	 

Step 7 Repeat **Step 6** to modify the tag names of other channel recording files.

---End

Delete Tag

Assume that you want to delete the tag name **Human detection** in D1 on October 30, 2021.

Procedures:

Step 1 [Log in to the GUI of the NVR.](#)

Step 2 Navigate to **Playback > Tag**, and tick D1.

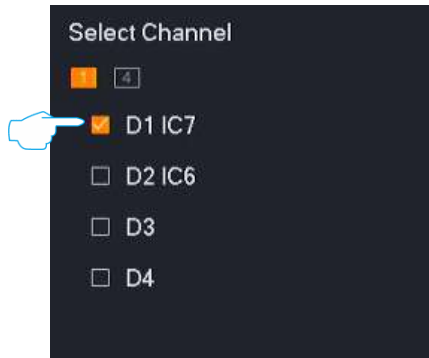

Step 3 Select time, which is **00:00:00** to **23:59:59** on **October 30, 2021**, in this example.

Step 4 Enter the tag name of the recording file you want to delete in **Tag Name**, which is **Human detection** in this example.

Step 5 Click **Search**.



Step 6 Find the tag of the recording file that you want to delete, and click  behind the recording file. Click **OK** in the pop-up dialog window.

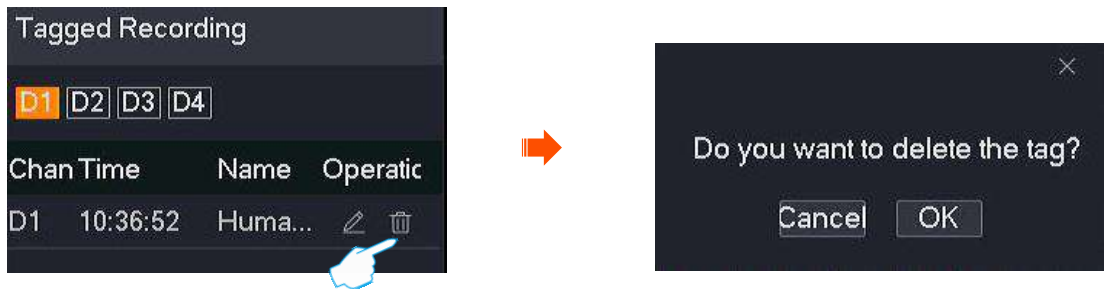

Step 7 Repeat **Step 6** to delete the tag names of other channel recordings files.

---End

4.5.5 Clip and Export the Recording File

Assume that you want to intercept a target recording and save it to the USB storage device.



The NVR can only recognize USB storage devices formatted as FAT32 for now.

Method 1

It is applicable for the NVR that cannot be connected to the mouse and the USB storage device at the same time.

Step 1 [Log in to the GUI of the NVR.](#)

Step 2 Enter the **Playback** page to play back the recording file.

Step 3 Click  in the lower-left corner.

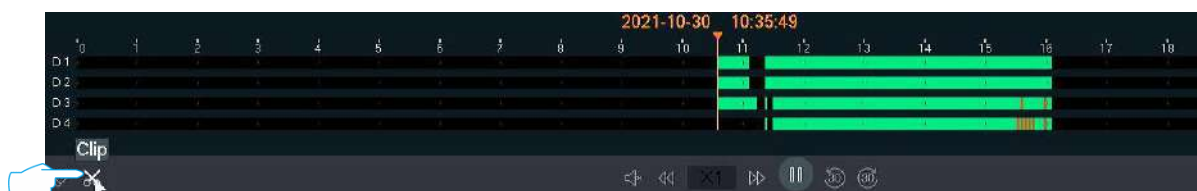

When multi-channel recordings are played back, the clipped recording file is one of the currently selected channels.

Step 4 Set the start time and end time of the editing, which are **00:11:00** to **00:16:00** in this example, and then click .

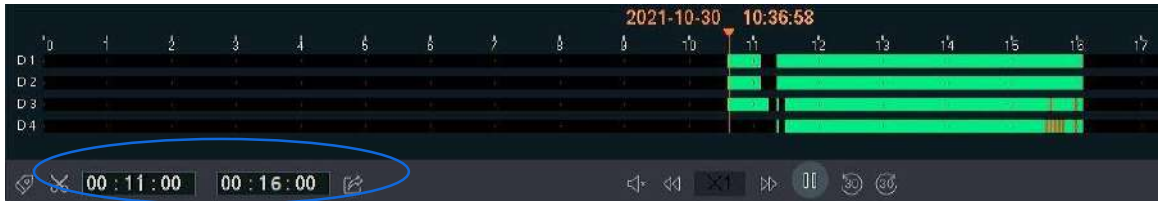

Step 5 Set the name of the recording file, which is **Alarm** in this example, and click **Export**.

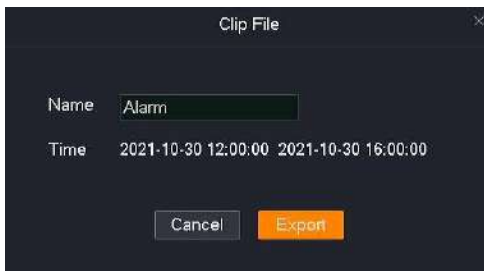

Step 6 Unplug the mouse and connect the USB storage device to the USB port of the NVR within 1 minute.

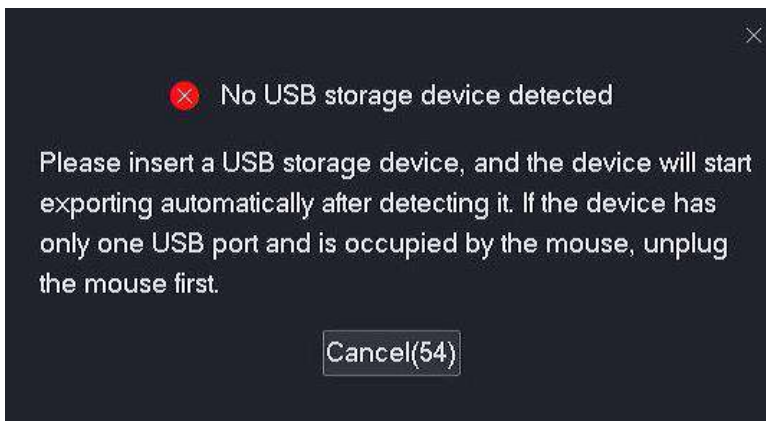

---End

The recording files with the suffix of .mp4 (R means normal recording, M means alarm recording) will be exported to the root directory of the USB storage device.

Method 2

It is applicable for the NVR that can be connected to the mouse and the USB storage device at the same time.



If the NVR has only one USB port or the USB port has been used, you need to prepare a USB hub by yourself.

- Step 1** Connect the USB storage device to the USB port of the NVR.
- Step 2** [Log in to the GUI of the NVR.](#)
- Step 3** Enter the GUI of the NVR. Enter the **Playback** page to play back the recording file.
- Step 4** Click  in the lower-left corner.



When multi-channel recordings are played back, the clipped recording file is the recording file of the currently selected channel.

- Step 5** Set the start time and end time of the editing, which are **00:11:00** to **00:16:00** in this example, and then click .

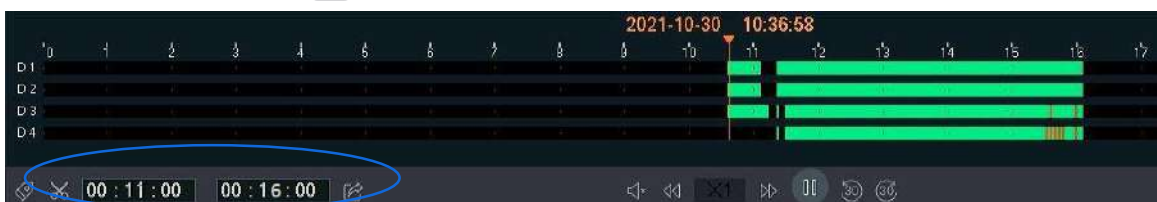

- Step 6** Set the name of the recording file, which is **Alarm** in this example, and click **Export**.

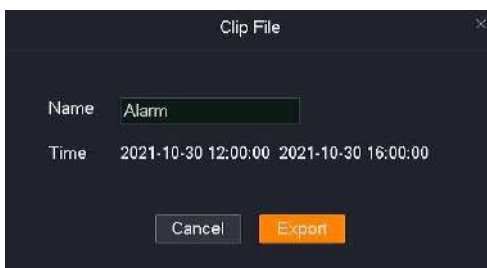

Step 7 Click the drop-down list to select your USB storage device, and click **Export**.

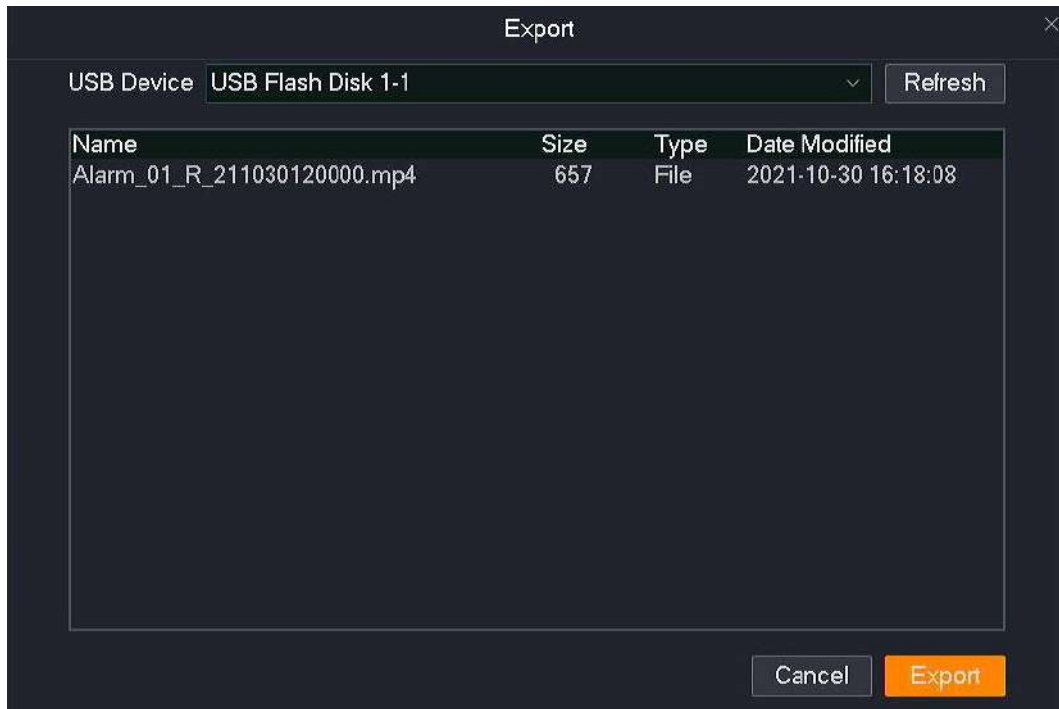

---End

The recording files with the suffix of .mp4 (R means normal recording, M means alarm recording) will be exported to the root directory of the USB storage device.

4.6 Configuration

On the configuration page, you can configure the primary functional parameters of the device, including channel management, storage management, alarm management, network configuration, and system configuration.

The configuration page supports basic settings and professional settings. Unless otherwise specified, the professional settings are illustrated here.

4.6.1 Show or Hide Professional Setting

Click **Configuration** to enter the page.

The professional mode is disabled by default. If you want to enable the professional mode for more settings, perform the following operations.

Enter the GUI of the NVR, click **Configuration**, find and click **Show Pro Settings** in the lower-left corner.

The screenshot shows the Tenda NVR Configuration page. The 'Configuration' tab is selected. The 'Auto add LAN cameras' toggle is turned on. The 'Online Camera' section is currently empty. Below it, there is an 'Add' button and a 'Manual' button. The 'Added Camera' table shows the following data:

Channel	Channel Name	IP Address	Model	Status	S/N	Version	Protocol	Port	Operation
<input type="checkbox"/> D1	IC7	192.168.0.149	IC7	Online	CB25956260	2111042006	ONVIF	6683	
<input type="checkbox"/> D2	IC6	192.168.0.156	IC6	Online	null	2112071022	ONVIF	6683	
<input type="checkbox"/> D3	IC7								
<input type="checkbox"/> D4	IT7								

The 'Remaining Bandwidth' is 59.2Mbps. A 'Show Pro Settings' button is located in the bottom-left corner, indicated by a hand cursor icon.

4.6.2 Channel Management

On the channel management page, you can manage cameras and configure OSD display, image parameters, and video parameters.

Camera Management

Overview

Navigate to **Configuration > Channel > Camera**.

You can manage cameras here, such as adding, editing or deleting cameras, upgrading camera software and viewing camera status.





- **Online Camera:** It displays the cameras currently in the same local area network as the NVR.
- **Added Camera:** It displays the cameras that have been successfully added to the NVR.

The screenshot displays the Camera Management interface. At the top, there is a toggle for 'Auto add LAN cameras' which is turned on. Below this, the 'Online Camera' section is currently empty, indicated by an 'Empty' message. There are 'Add' and 'Manual' buttons below the Online Camera table. The 'Added Camera' section shows a table with two entries, D1 and D2, both with 'Online' status. The 'Remaining Bandwidth' is shown as 59.0Mbps. A 'Delete' button is located at the bottom left of the interface.



No.	IP Address	Model	Status	S/N	Protocol	Port	Operation
Empty							

Channel	Channel Name	IP Address	Model	Status	S/N	Version	Protocol	Port	Operation
<input checked="" type="checkbox"/>	D1	192.168.0.140	TD-L33DS1201	Online	PC50739472	2111220953	ONVIF	6638	↶ 🗑️
<input checked="" type="checkbox"/>	D2	192.168.0.149	IC7	Online	CB25956250	2111042006	ONVIF	6638	↶ 🗑️

Parameter & button description

Parameter	Description
Auto add LAN cameras	<p>It specifies whether to enable the NVR to automatically add the LAN port camera function.</p> <p>Once it is enabled, the camera connected to the NVR can be discovered and added automatically within 2 minutes after the NVR is started. After 2 minutes, the camera can be discovered automatically and a prompt will be displayed through a pop-up window, you can manually add it.</p>
No.	It specifies the number of the camera.
IP address	It specifies the IP address of the camera.
Model	It specifies the model of the camera.
Status	<p>It specifies the status of the camera.</p> <p>Online indicates that the camera and the NVR are in the same LAN and the status is normal.</p>
S/N	<p>It specifies the S/N of the camera.</p> <p>The system can only recognize the S/N of the camera that supports the private protocol of Tenda.</p>
Protocol	It specifies the protocol supported by the camera.
Online camera	It specifies the port number of the protocol supported by the camera.
Operation	<p>It is used to perform operations for the camera:</p> <ul style="list-style-type: none"> – Click  to add the camera to the NVR. – Click  to modify the network parameters of the camera (such as IP address and subnet mask), and enable/disable the Auto Add camera (in the same LAN as the NVR) function. <p> NOTE</p> <p>The Auto Add function only takes effect when the Auto add LAN cameras function is enabled.</p>
	<p>It is used to add selected Online Camera in batches.</p> <p>When cameras are batch added, the system uses the user name and password of the admin account of the NVR to activate the cameras.</p>

Parameter	Description
Manual	<p>It specifies you can add cameras by entering the IP address, protocol, port, user name, and password of the camera.</p> <p>Generally used to add cameras that are not in the same LAN as the NVR.</p>
Remaining Bandwidth	It specifies the remaining bandwidth of the access bandwidth of the NVR (used for receiving the camera data). When the bandwidth is insufficient, the camera cannot be added.
Channel	It specifies the channel number of the camera.
Channel name	It specifies the channel name of the camera.
IP address	It specifies the IP address of the camera.
Model	It specifies the model of the camera.
Added Camera Status	<p>It specifies the status of the camera.</p> <ul style="list-style-type: none"> – Connecting... (Logging in...): It specifies the NVR is trying to log in to the camera. – Online: The camera is successfully added to the NVR, and you can view or manage the camera through the GUI of the NVR. – Exception: The NVR failed to add a camera. The detailed description is as follows. <ul style="list-style-type: none"> • Disconnected: The camera is not connected to the NVR. Ensure that the camera is working properly. • Incorrect user name or password: The user name or password of the camera is incorrect. • The user has been locked: The login account of the camera has been locked. • Network error: The network between the camera and the NVR is disconnected. Ensure that the network connection between the camera and the NVR is normal, and the network parameters are configured correctly.
S/N	It specifies the serial number of the camera.
Firmware Version	It specifies the firmware version of the camera.
Protocol	It specifies the protocol used by the camera to connect to the NVR.
Port	It specifies the port number of the protocol used by the camera to connect to the NVR.

Parameter	Description
Operation	<p>It is used to perform operations for the camera:</p> <ul style="list-style-type: none"> – Click  to modify the camera bound to the channel, such as IP address, protocol, port. – Click  to delete the camera. – Click  to upgrade the firmware of the camera.
<input type="button" value="Delete"/>	It is used to delete selected Online Camera in batches.
<input type="button" value="Upgrade"/>	It specifies you can upgrade the firmware for the selected camera.

Add Camera

The number of cameras that can be added varies with NVR models, and the actual product prevails. You can add cameras by following the operations below when the number of added cameras does not reach the upper limit.



- If you want to add other brand cameras, please connect the camera to the LAN where the NVR is located using an Ethernet cable.
- If it is a camera in the video security kit, the camera can be discovered and added automatically within 120 seconds after the NVR is started. After the NVR is working properly, the camera can be discovered automatically, and you need to add the camera manually.
- When adding cameras in the kit, please ensure that the cameras are in the factory settings. If not, please reset the camera first.
- If the camera is connected to the PoE port of the NVR, the camera will be discovered and added by the system within 2 minutes.

Add Cameras that are in the Same LAN as the NVR.

- Step 1** Connect the camera to the LAN where the NVR is located. If the Wi-Fi camera is included in the video security kit, place the camera within the coverage range of the NVR.
- Step 2** [Log in to the GUI of the NVR.](#)
- Step 3** Navigate to **Configuration > Channel > Camera.**
- Step 4** Find the **Online Camera** module, then add the camera.

Method 1:

Select the camera you want to add according to the S/N, and click **Add**.



If the user name and password of the camera to be added are different from the NVR, please add the camera by method 2.

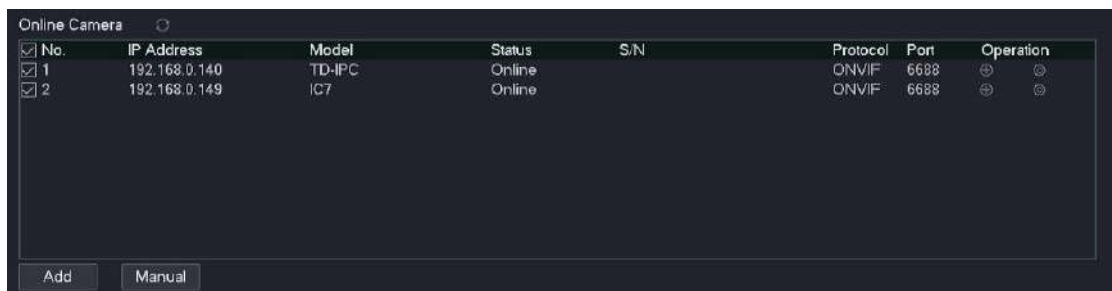

Method 2:

- Find the camera you want to add according to the S/N, then click  behind the camera.

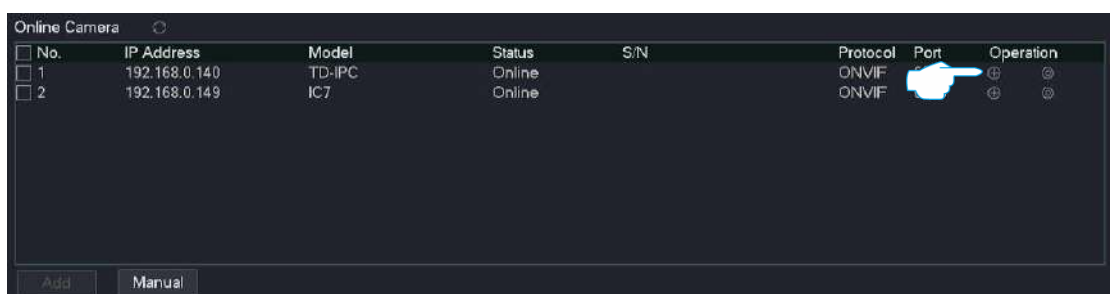

2. Select the protocol of the camera, enter the port, user name and password, and click **Add**.

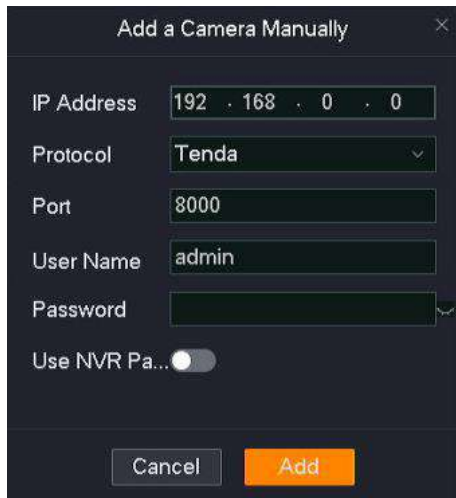

IP Address: 192 . 168 . 0 . 0

Protocol: Tenda

Port: 8000

User Name: admin

Password: [Empty]

Use NVR Pa...

Buttons: Cancel, Add

3. If you want to add other cameras, repeat steps 1 to 2.

---End

Wait a moment. The camera is added successfully. You can check the added camera in the **Added Camera** module.

Added Camera										Remaining Bandwidth: 59.0Mbps	
<input type="checkbox"/>	Channel	Channel Name	IP Address	Model	Status	S/N	Version	Protocol	Port	Operation	
<input type="checkbox"/>	D1	IC7	192.168.0.149	IC7	● Online	CB25956260	2111042006	ONVIF	6688		
<input type="checkbox"/>	D3		192.168.0.140	TD-L33DS1201	● Online	PC50739472	2111220953	ONVIF	6688		

Delete

Add Cameras that are not in the Same LAN as the NVR.

Step 1 Connect the camera to a network that is routable to the NVR using an Ethernet cable.

Step 2 [Log in to the GUI of the NVR.](#)

Step 3 Navigate to **Configuration > Channel > Camera.**

Step 4 Find the **Online Camera** module, and click **Manual**.

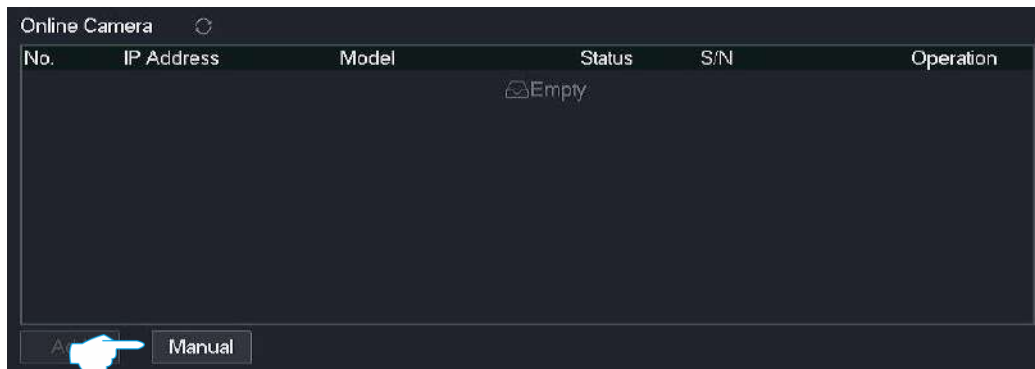

Step 5 Enter the IP address of the camera, select the protocol of the camera, enter the port, user name and password, and click **Add**. (The parameters in the figure are for reference only.)

---End

Wait a moment. The camera is added successfully. You can view the added camera in the **Added Camera** module.

Channel	Channel Name	IP Address	Model	Status	S/N	Version	Operation
<input type="checkbox"/> D1	Tenda IPC	10.251.251.114	KCT6	● Online	TD123450035654	V11.10.00.489	
<input type="checkbox"/> D2	Tenda IPC	10.251.251.153	IC7	● Online	TD123450035653	V11.10.00.489	
<input type="checkbox"/> D3	Tenda IPC	10.251.251.162	IC7	● Online	TD123450035667	V11.10.00.489	
<input type="checkbox"/> D4	Tenda IPC	192.168.8.201	IT7	● Online	TD123450035666	V11.10.00.489	

Buttons:

Upgrade Firmware of the Camera

The device can obtain new or more stable performance through a firmware upgrade.



- Before upgrading the camera firmware, ensure that the status of the camera is **Online**.
- After the camera firmware is upgraded successfully, the camera will automatically reboot and reconnect to the NVR.
- The NVR can only recognize USB storage devices formatted as FAT32 for now.

Method 1

It is applicable for the NVR that cannot be connected to the mouse and the USB storage device at the same time.

Step 1 Visit www.tendacn.com to download the latest upgrade firmware of the corresponding camera model, and unzip it to the root directory of the USB device.

Step 2 [Log in to the GUI of the NVR.](#)

Step 3 Navigate to **Configuration > Channel > Camera.**

Step 4 Find the **Added Camera** module, and upgrade the firmware of the camera.

Method 1: It is applicable for upgrading the firmware of multiple cameras at the same time.

Find the cameras you want to upgrade according to the S/N, tick the camera channel number, and click **Upgrade**.

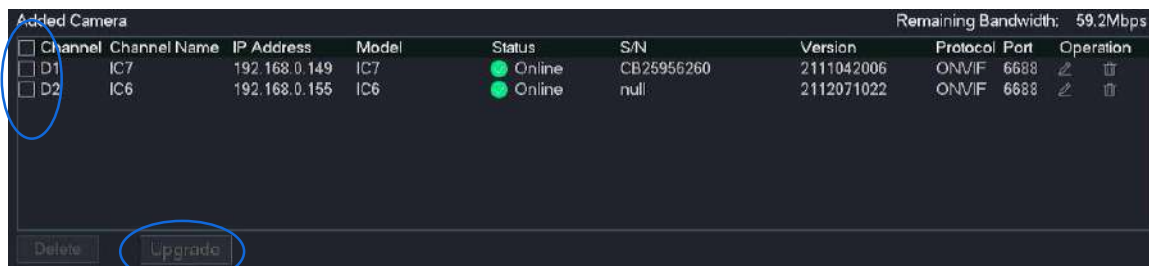

Method 2: It is applicable for upgrading the firmware of a single camera.

Find the camera you want to upgrade according to the S/N, and click behind the camera.

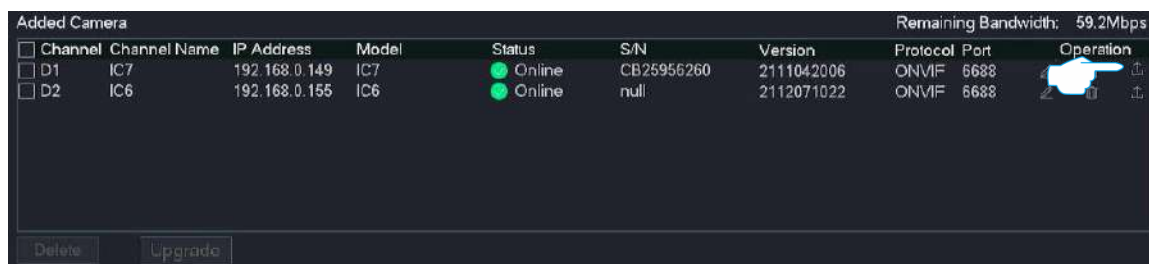

Step 5 Unplug the mouse and insert the USB storage device with the upgrade file in the root directory within 1 minute. The camera will be upgraded automatically.

---End

After the upgrade completes, you can unplug the USB device.

Method 2

It is applicable for the NVR that can be connected to the mouse and the USB storage device at the same time.



If the NVR has only one USB port or the USB port has been used, you need to prepare a USB hub by yourself.

- Step 1** Visit www.tendacn.com to download the latest upgrade firmware of the corresponding camera model, and unzip it to the root directory of the USB device.
- Step 2** Connect the USB storage device to the USB port of the NVR.
- Step 3** [Log in to the GUI of the NVR.](#)
- Step 4** Navigate to **Configuration > Channel > Camera.**
- Step 5** Find the **Added Camera** module, and upgrade the firmware of the camera.

Method 1: It is applicable for upgrading the firmware of multiple cameras at the same time.

Find the cameras you want to upgrade according to the S/N, tick the camera channel number, and click **Upgrade**.

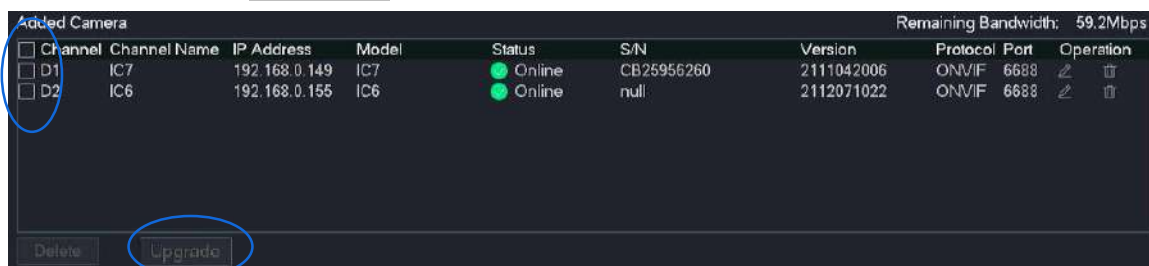

Method 2: It is applicable for upgrading the firmware of a single camera.

Find the camera you want to upgrade according to the S/N, and click behind the camera.

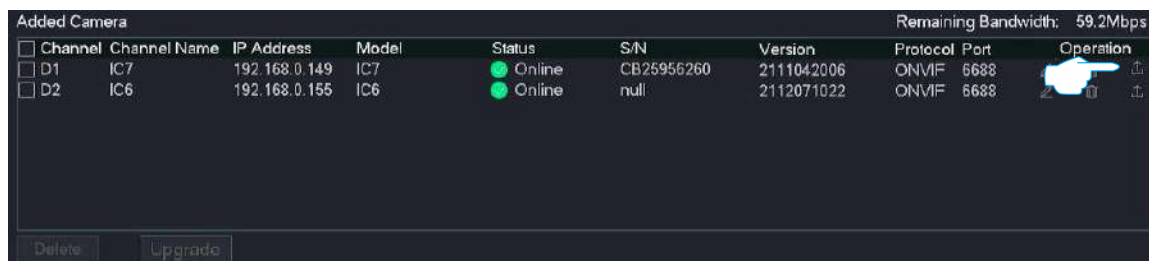

Step 6 Select the USB device and upgrade file, and click **Upgrade**.

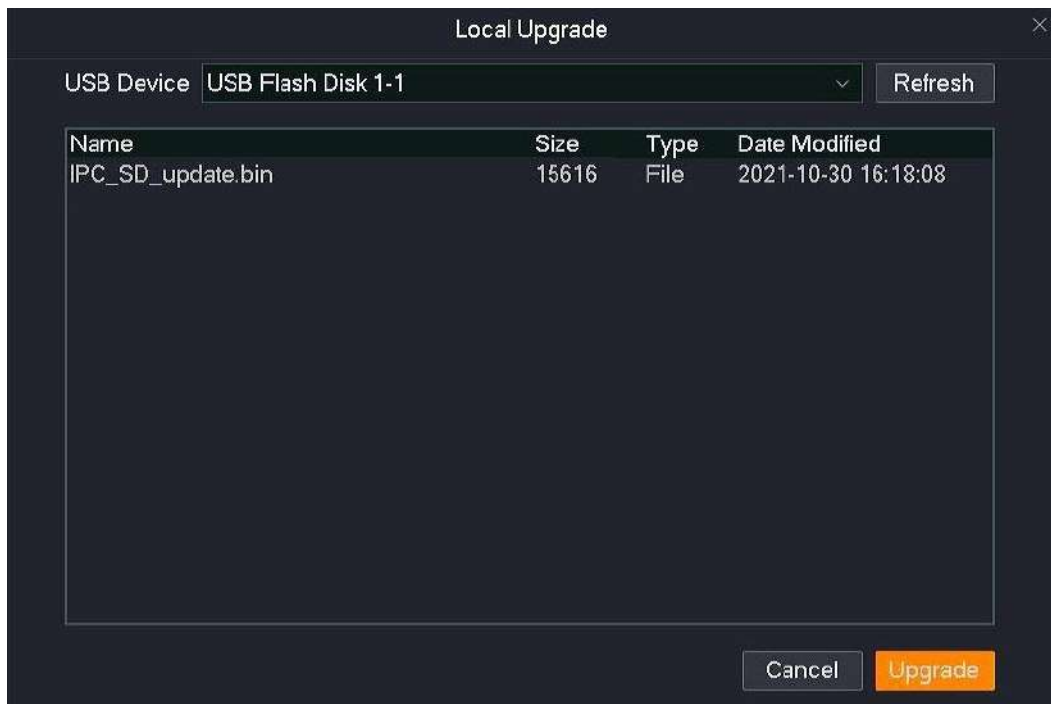

---End

OSD Configuration

Overview

Navigate to **Configuration > Channel > OSD**.

On-Screen Display (OSD) refers to displaying the required information on the screen. The OSD of the local live view supports the display of the channel name for now.

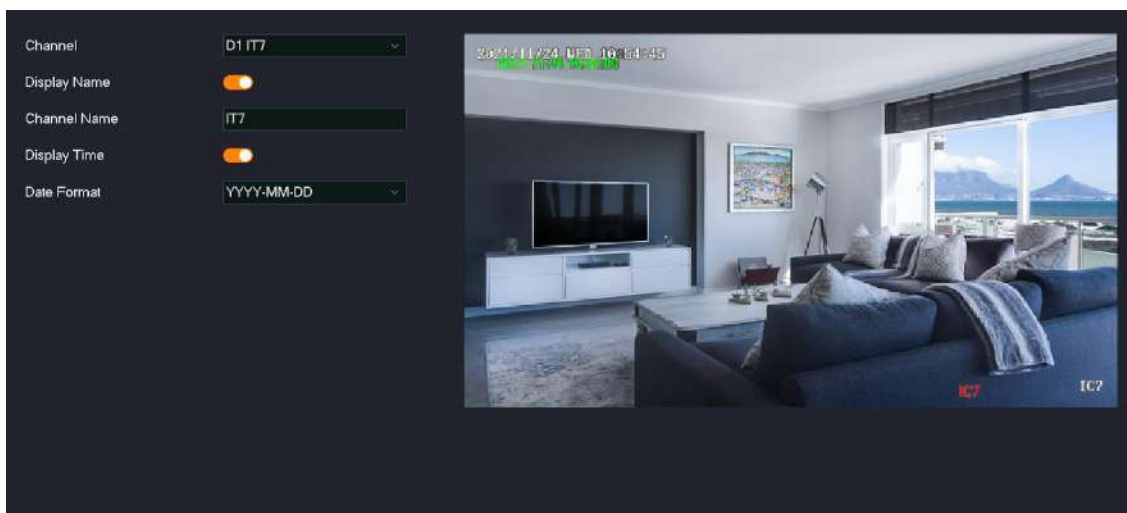

Parameter description

Parameter	Description
Channel	It specifies the channel to be selected for OSD configuration.
Display Name	It specifies the channel name can be displayed or hidden.
Channel name	It specifies the channel name. You are recommended to modify the channel name to the description of the installation position of the channel camera so that you can quickly locate each camera when managing multiple cameras.
Display Time	It specifies the system can be displayed or hidden.
Time Format	It specifies the format of the camera system time display.
Sync to	It is used to synchronize the OSD configuration parameters of the current channel to other channels.

Modify OSD

Assume that the camera of D1 is installed in the living room, you can modify channel name and location, time format and location to manage the camera easily.

Procedures:

- Step 1** [Log in to the GUI of the NVR.](#)
- Step 2** Click **Configuration > Channel > OSD.**
- Step 3** Set **Channel**, which is **D1** in this example.
- Step 4** Modify the channel name, which is the **Living room** in this example.
- Step 5** Select the display format of the camera system time.
- Step 6** Click and drag the time shown in green and the channel name shown in red to the position you want to display in the live view window on the right (the following figure is for reference only).
- Step 7** Click **Save** at the bottom of the page.

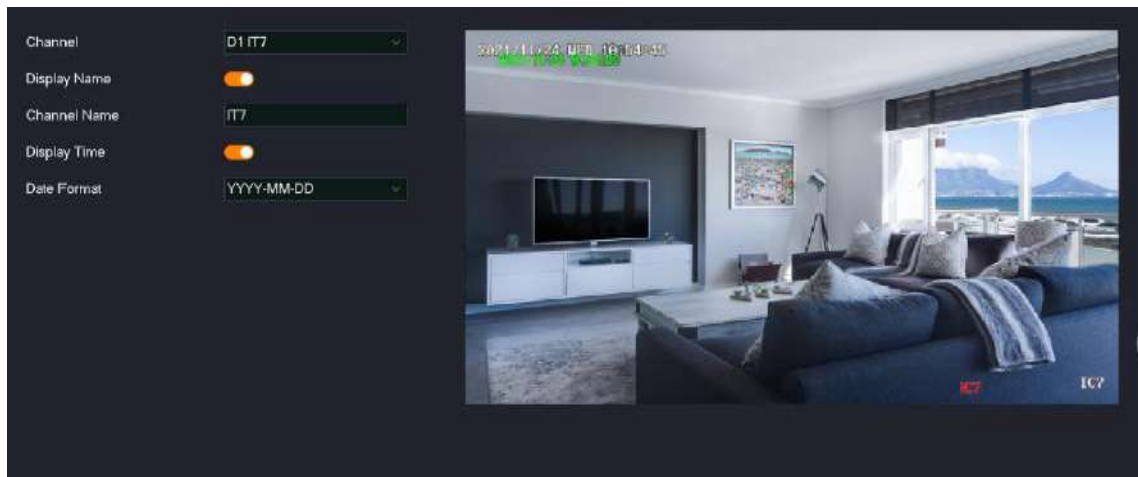

---End

After the setting completes, the channel name and position, system time display format and position of the camera D1 are the values currently set.

Image Configuration

Overview

Navigate to **Configuration > Channel > Image**. The N3W-4H is taken as an example here.

The image configuration function enables you to adjust the image parameters to improve the visual effect of the camera monitoring image. You can also set the day and night switching mode of the camera.

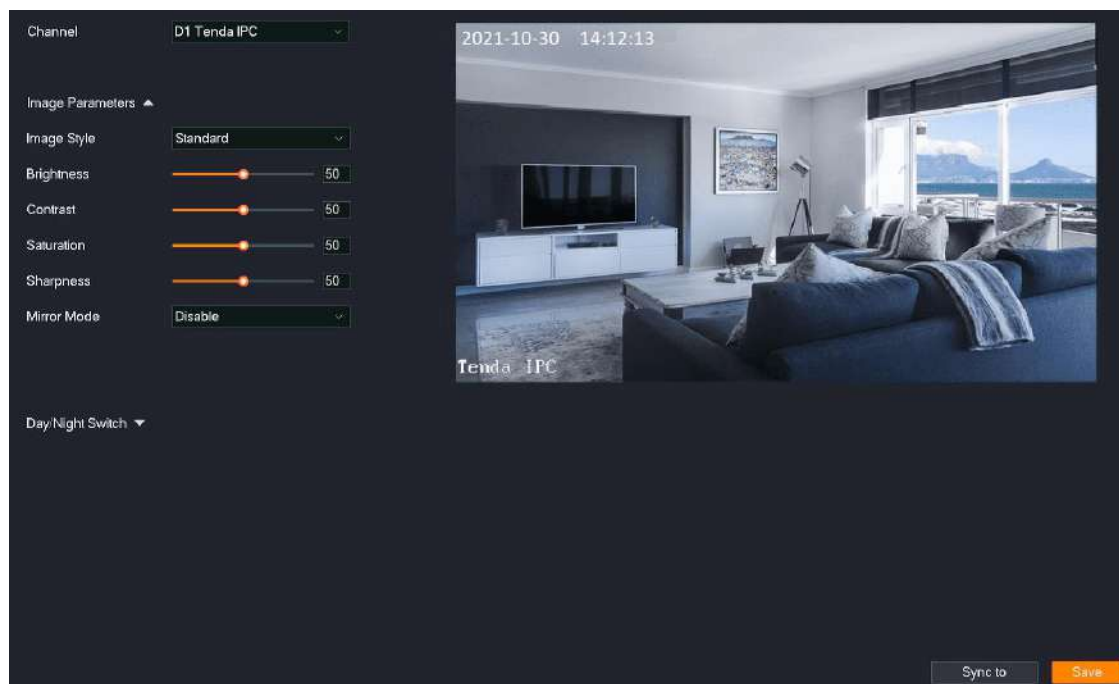

Parameter description

Parameter	Description	
Channel	It specifies the channel selected for adjusting the image parameters.	
Image Parameters	Image Style	It specifies the monitor image style. Standard, transparent, soft are supported for now.
	Brightness	It specifies the brightness of the image. The brightness value can be adjusted when the overall monitoring image is dark or bright. The larger the value, the brighter the image.
	Contrast	It specifies the ratio of the lightest area to the darkest area in the image. The contrast value can be adjusted when the sense of layering in the monitoring image is poor and the contrast between the white and black of the image is insufficient. The larger the value, the greater the contrast between light and dark of the image.
	Saturation	It specifies the saturation of the image.

Parameter	Description
Saturation	It specifies the vividness of the colors in the image. The larger the value, the more vivid the image color.
Sharpness	It specifies the sharpness of the edges of the image. The larger the value, the more obvious the edges of the image.
Mirror Mode	<p>It specifies the direction of the monitoring image.</p> <ul style="list-style-type: none"> – Disable: It specifies the image will not be mirrored. – Up-Down: It specifies the image will be reversed up and down. – Left-Right: It specifies the image will be reversed left and right. – Center: It specifies the image will be changed up and down, left and right. This mode can be selected when the camera is installed upside down.
Mode	<p>It specifies the day and night switching mode of the camera image.</p> <p>Auto Switch is supported for now. It means that the camera automatically switches to day mode (the monitoring image is always in color) or night mode according to the environment brightness.</p>
Day/Night Switch	<p>It specifies the camera monitoring image effect at night.</p> <ul style="list-style-type: none"> – Black & white: The infrared supplement light of the camera is enabled, and the monitoring image is always in black and white. – Full Color: The white supplement light of the camera is enabled, and the monitoring image is always in color. – Smart: When a moving object or human figure is detected, the white light of the camera will be enabled and the monitoring image will be in color, otherwise the infrared light will be enabled and the monitoring image will be in black and white.
Night Vision Mode	
Sync to	It is used to synchronize the image configuration parameters of the current channel to other channels.

Adjust Camera Image Parameter

If the monitoring images of D1, D2, D3 and D4 are not clear on the **Live View** page, you can try to adjust the image parameters of the camera.

Procedures:

Step 1 [Log in to the GUI of the NVR.](#)

Step 2 Navigate to **Configuration > Channel > Image**.

Step 3 Adjust the image parameters of the camera D1.

1. Select **Channel**, which is **D1** in this example.
2. Modify the relevant parameters such as **Image Style**, **Brightness** and **Contrast** according to the live view effect of the image on the right.

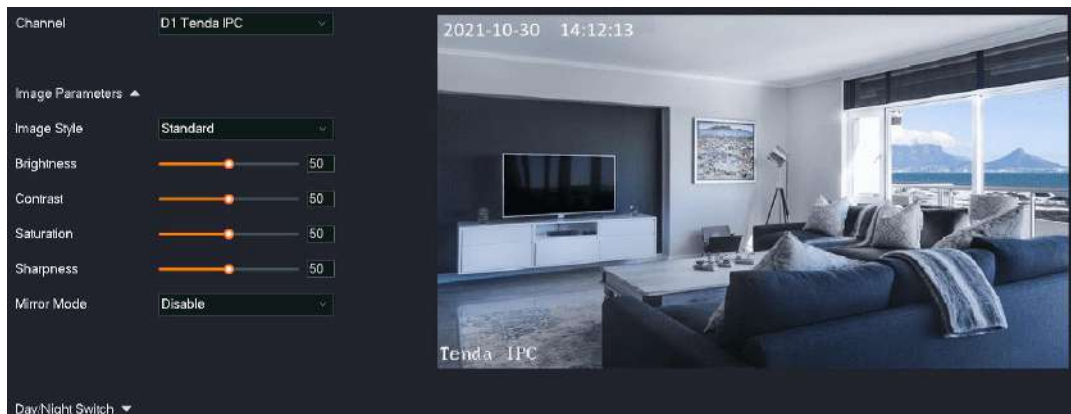

Step 4 Adjust the image parameters of other channel cameras.

Click **Sync to** at the bottom of the page, and select the channel to synchronize the image parameter configuration of the D1 camera, which is **D2** to **D4** in this example.

Step 5 Click **Save**.

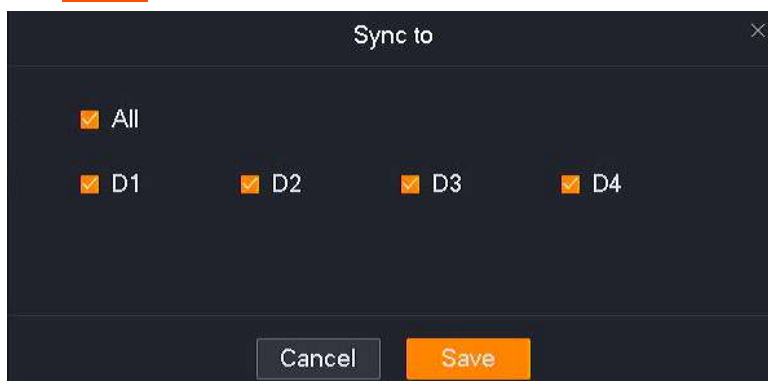

---End

Set Night Vision Mode of the Camera

Assume that you want the monitoring images of D1, D2, D3, and D4 cameras to be colored during the day and night, you can modify the night vision mode of the cameras.

Procedures:

Step 1 [Log in to the GUI of the NVR.](#)

Step 2 Navigate to **Configuration > Channel > Image**.

Step 3 Set the night vision mode of the D1 camera.

1. Select **Channel**, which is **D1** in this example.
2. Click the drop-down list of **Night Vision Mode** to modify the night vision mode, which is **Full Color** in this example.



Step 4 Adjust the night vision mode of other channel cameras.

Click **Sync to** at the bottom of the page, and select the channel to synchronize the image parameter configuration of the D1 camera, which is **D2 to D4** in this example.

Step 5 Click **Save**.

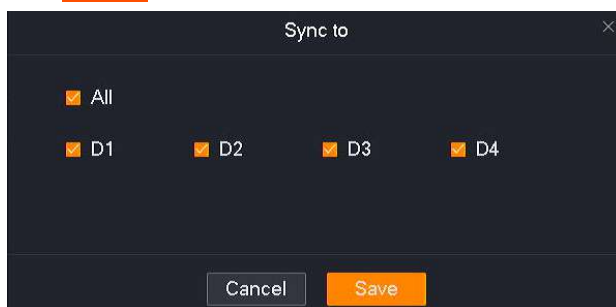

---End

After the setting completes, the monitoring images of D1, D2, D3 and D4 cameras are in color during the day. The white supplement light is enabled at night so that the monitoring images are also in color.

Audio and Video Configuration

Navigate to **Configuration > Channel > Audio & Video**. The N3W-4H is taken as an example here. The audio and video configuration function enables you to adjust the video encoding or audio encoding parameters. Only video encoding parameters can be adjusted.

By default, **Stream Adaptive** is enabled, and the system automatically adjusts video encoding parameters according to Wi-Fi network conditions. If you want to manually adjust the video encoding parameters, please disable the **Stream Adaptive** function.

The screenshot displays the 'Audio and Video Configuration' interface for a channel named 'D1 D1 Tenda IPC'. The interface is divided into two columns: 'Main Stream' and 'Sub-stream'. The 'Stream Adaptive' toggle is currently turned on. The 'Main Stream' settings are: Encoding Type: H.265, Resolution: 3M(2304*1296), Frame Rate: 15 fps, Bitrate Type: (empty), and Bitrate: 256 Kbps. The 'Sub-stream' settings are: Encoding Type: H.265, Resolution: 640 * 360, Frame Rate: 15 fps, Bitrate Type: (empty), and Bitrate: 64 Kbps. At the bottom right, there are 'Sync to' and 'Save' buttons.

Parameter	Main Stream	Sub-stream
Channel	D1 D1 Tenda IPC	
Stream Adaptive	On	
Encoding Type	H.265	H.265
Resolution	3M(2304*1296)	640 * 360
Frame Rate	15 fps	15 fps
Bitrate Type		
Bitrate	256 Kbps	64 Kbps

Parameter description

Parameter	Description
Channel	It specifies the channel chosen to adjust image parameters.
Stream Adaptive	It specifies whether the Stream Adaptive function is enabled. When it is enabled, the system automatically adjusts the resolution and bit rate according to changes in the network environment.
Main Stream	They specify the stream types of the video. <ul style="list-style-type: none"> – Main stream: The stream has a large value and a high occupied bandwidth, which is applicable for large-screen monitoring and storage.
Sub-stream	<ul style="list-style-type: none"> – Sub-stream: The stream has a small value and a small occupied bandwidth, which is applicable for small-screen monitoring and network transmission.
Encoding Type	<p>It specifies the encoding standard of the video.</p> <ul style="list-style-type: none"> – H.264 (H.264M): A generation of highly compressed video codec standards after MPEG4, which improves compression efficiency under the same video quality. – H.265: A generation of video coding standards after H.264, which improves the bit stream, coding quality, delay to optimize coding and save more bandwidth and capacity under the same video quality. <p> TIP</p> <p>Different cameras support different encoding standards. The actual page prevails.</p>
Resolution	It specifies the number of pixels contained in a frame of an image. The higher the resolution, the clearer the image and the more obvious details.
Frame Rate	It specifies the number of video frames displayed per second. The higher the frame rate, the smoother the image.
Smart Encoding	<p>Adopt H.264+ and H.265+ encoding standards, which is an optimization compared to H.264 and H.265.</p> <p>It specifies the smart encoding function can be enabled to maximize compression efficiency, expand storage time and save HDD capacity while ensuring image quality.</p>

Parameter	Description
Bitrate Type	<p>It specifies the bit rate control method of the video.</p> <ul style="list-style-type: none">– Fixed: The fixed bitrate tries to encode according to the upper limit of the bit rate, and the bit rate will fluctuate up and down in the bit rate value, and will not change with the monitoring scene.– Variable: The bit rate will change with the monitoring scene. Adopt a high bit rate when the monitoring scene is moving or changing. The variable bitrate adopts a lower bit rate when the monitoring scene is static.
Bitrate	<p>It specifies the size of the video data per unit time. The larger the bit rate, the better the picture quality.</p>

4.6.3 Storage Management

On the storage management page, you can manage the Hard Disk Driver (HDD) and set recording schedules.

HDD Management

Overview

Navigate to **Configuration > Storage > HDD**.

You can check HDD status, format HDD and set storage policy when the HDD is full.

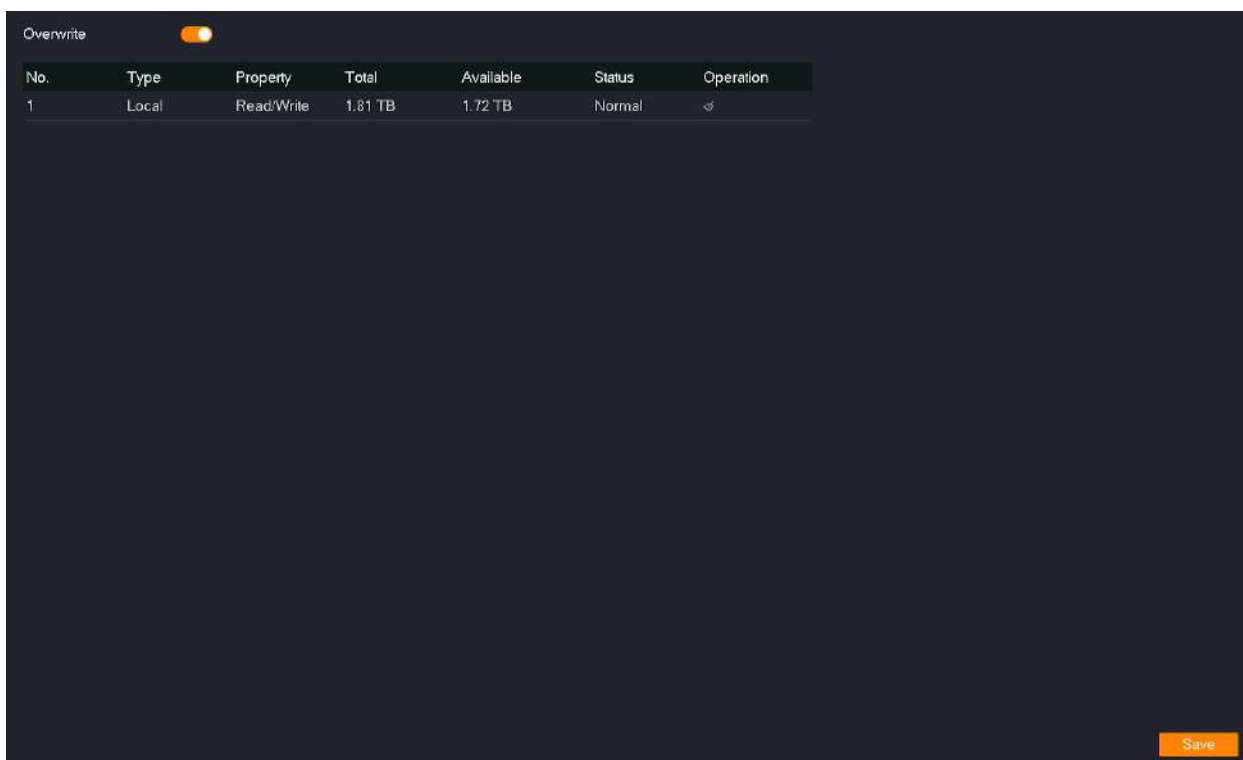

Parameter description

Parameter	Description
Overwrite	It specifies storage policy when HDD space is full. After it is enabled, if the HDD is full, the oldest recording files will be overwritten cyclically.
No.	It specifies the number of the HDD.
Type	It specifies the type of HDD. Local is supported for now, which means that the HDD is installed inside the NVR.

Parameter	Description
Property	It specifies the property of the HDD and cannot be modified for now.
Total	It specifies the total capacity of the HDD.
Available	It specifies the available capacity of the HDD.
Status	<p>It specifies the status of the HDD.</p> <p>If the HDD is abnormal. Try the following solutions:</p> <ul style="list-style-type: none"> – Please shut down the NVR first, reinstall the HDD and start up the NVR. – If the problem persists, please format the HDD.
Operation	<p>It is used to format the HDD.</p> <p> NOTE</p> <ul style="list-style-type: none"> – All data will be cleared and cannot be restored after the HDD is formatted. Please operate with caution. – If the format fails, please try again. If the problem persists, please shut down the NVR first, replace the HDD and start up the NVR.

Check HDD Status and Available Capacity

Log in to the GUI of the NVR, then navigate to **Configuration > Storage > HDD** to check HDD information, such as status and available capacity.

No.	Type	Property	Total	Available	Status	Operation
1	Local	Read/Write	1.81 TB	1.72 TB	Normal	

Format HDD

If the **Status** of the NVR is abnormal, or you want to clear the data of the HDD, you can format the HDD.



- All data will be cleared and cannot be restored after the HDD is formatted. Please operate with caution.
- If the formatting fails, please try again. If the problem persists, please shut down the NVR first, replace the HDD and start up the NVR.

Procedures:

- Step 1** Log in to the GUI of the NVR.
- Step 2** Navigate to **Configuration > Storage > HDD**.
- Step 3** Click the format button .

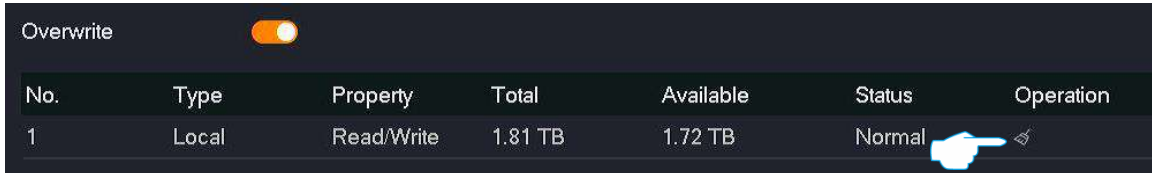

No.	Type	Property	Total	Available	Status	Operation
1	Local	Read/Write	1.81 TB	1.72 TB	Normal	

- Step 4** Read the prompt message, and click **OK**.

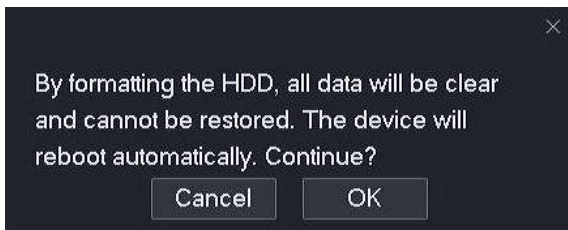

---End

The system will format the HDD.

Schedule

Overview

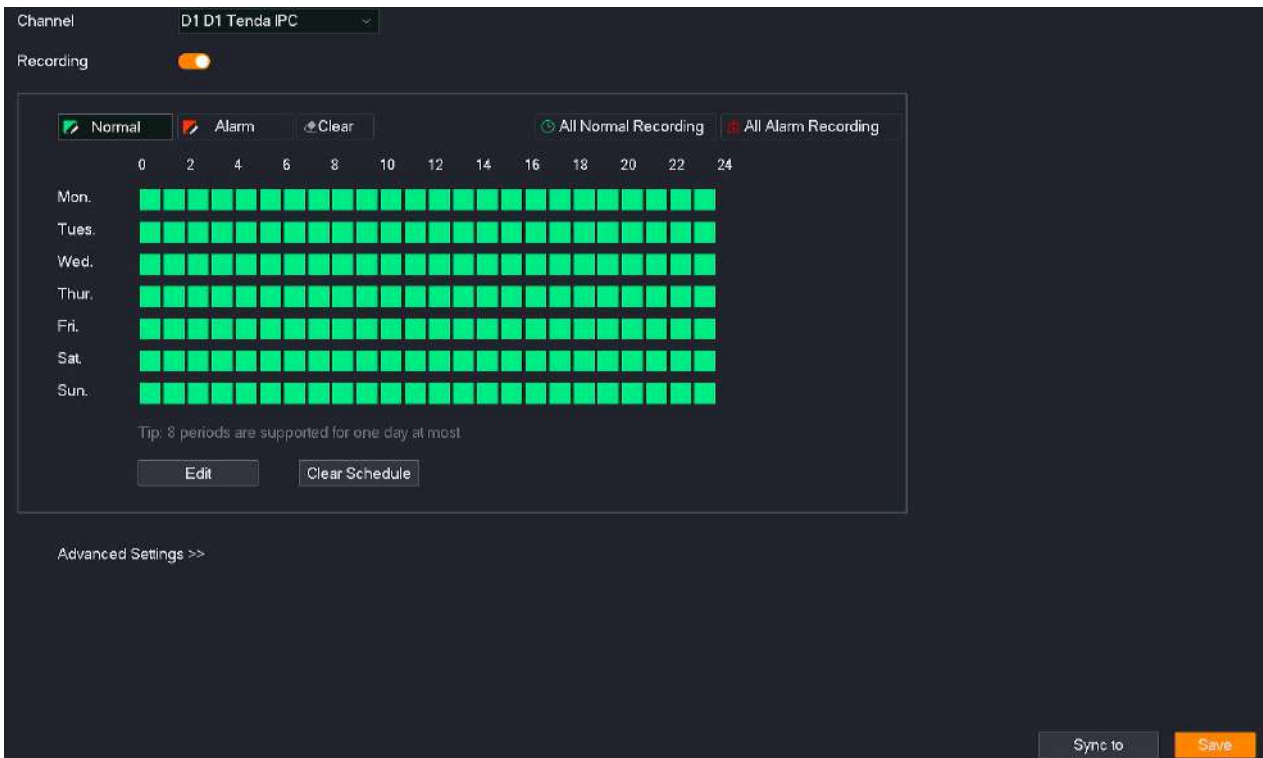

Navigate to **Configuration > Storage > Schedule**.

After the schedule is set, the system will record according to the schedule. By default, the system presets the schedule of 24 hours continuous normal recording for each channel, and you can modify the recording time and recording type as required.

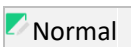
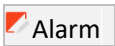
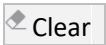

Parameter & button description

Parameter	Description
Channel	It specifies the channel chosen to set the schedule.
Recording	It specifies whether the recording function is enabled.
 Normal	Green means normal recording. It specifies the NVR always records. Click this button to draw the recording time in the timetable below.
 Alarm	Red means alarm recording. It specifies the NVR will only record when the camera triggers an alarm. Click this button to draw the recording time in the timetable below.
 Clear	It is used to clear the time that has been set in the timetable below. Click this button to clear the recording time in the timetable below.

Parameter	Description
 All Normal Recording	It is used to set a 24-hour normal recording from Monday to Sunday with one click.
 All Alarm Recording	It is used to set a 24-hour alarm recording from Monday to Sunday with one click.
Edit	It is used to edit the schedule for a specific time in detail.
Clear Schedule	It is used to clear the current recording schedule.
Sync to	It is used to synchronize the current schedule to other channels.
Post-record	Only applicable for Alarm . Click Advance to enter the page. It specifies the time of continuous recording after an alarm is finished.

Configure Schedule

Assume that you want to set a schedule for D1, D2, D3, and D4 cameras as shown in the table below:

Recording	Recording Time	Recording Type
Monday to Sunday	00:00 to 8:00	Not recording
Monday to Sunday	8:00 to 12:00	Alarm recording
Monday to Sunday	12:00 to 14:00	Normal recording
Monday to Sunday	14:00 to 18:00	Alarm recording
Monday to Sunday	18:00 to 24:00	Normal recording



After an alarm recording plan is set for the corresponding channel, the alarm event also needs to be set for the channel in the [Alarm Management](#).

Method 1

Step 1 [Log in to the GUI of the NVR.](#)

Step 2 Navigate to **Configuration > Storage > Schedule.**

Step 3 Set the schedule of the camera D1.

1. Set **Channel**, which is **D1** in this example, and enable the **Recording** function.
2. Click **Clear Schedule**.

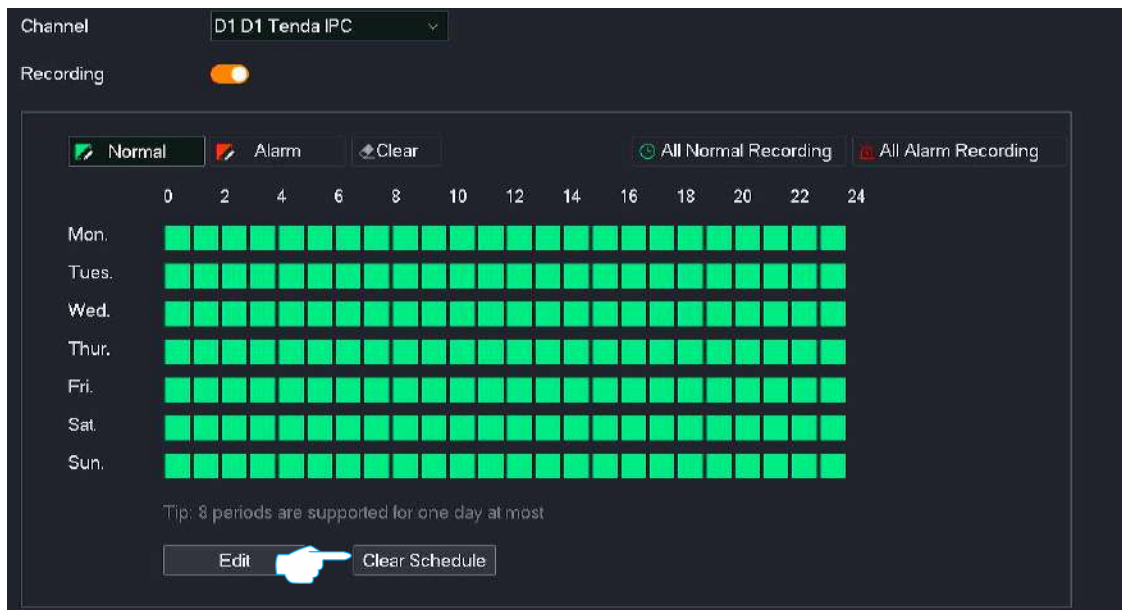

3. Click Normal, then hold down the left click and drag to draw the recording period, which is **12:00 to 14:00** and **18:00 to 24:00** from **Monday to Sunday** in this example.
4. Click Alarm, then hold down the left click and drag to draw the recording period, which is **8:00 to 12:00** and **14:00 to 18:00** from **Monday to Sunday** in this example.

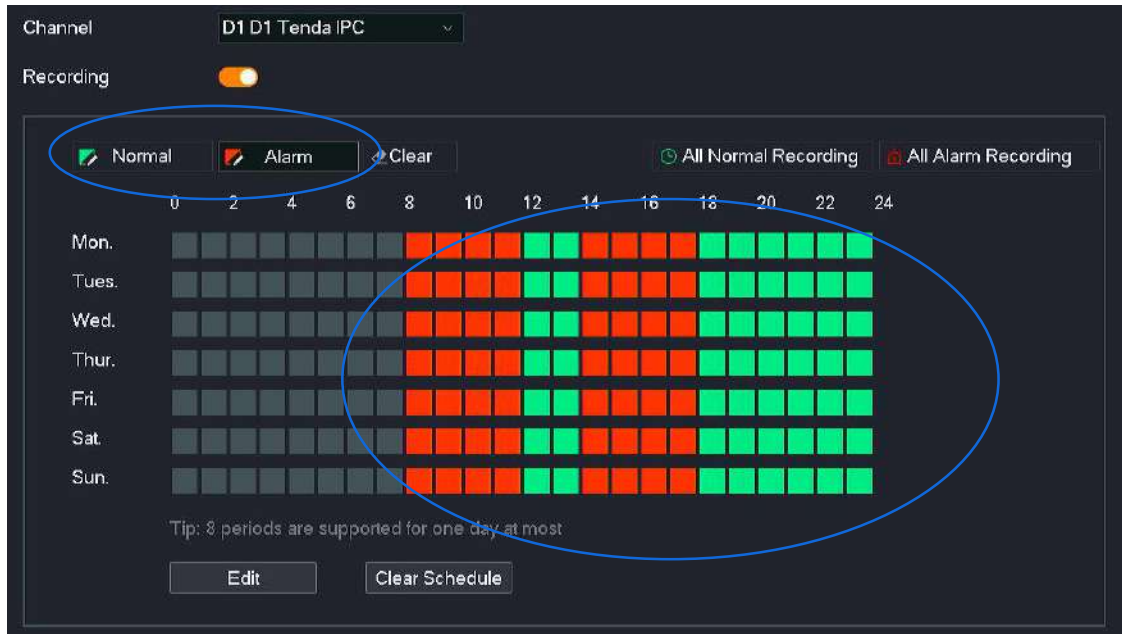

Step 4 Set the schedule of other channel cameras.

Click Sync to at the bottom of the page, and select the channel to synchronize the image parameter configuration of the D1 camera, which is **D2 to D4** in this example.

Step 5 Click Save .

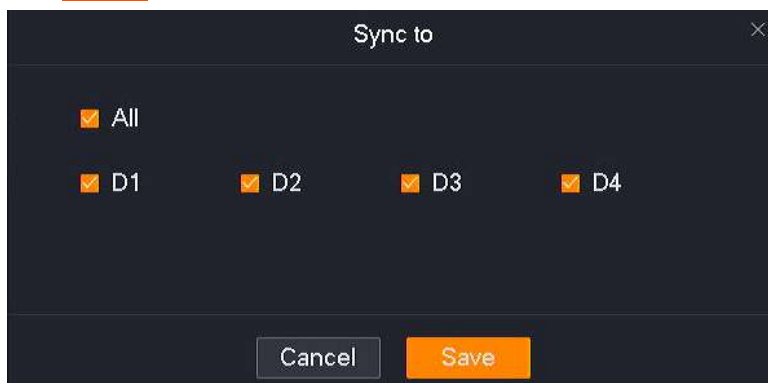

---End

After the setting completes, the system will enable the D1, D2, D3 and D4 cameras to record according to the above schedule.

Method 2

Step 1 [Log in to the GUI of the NVR.](#)

Step 2 Navigate to **Configuration > Storage > Schedule.**

Step 3 Set the schedule of the camera D1.

1. Set **Channel**, which is **D1** in this example, and ensure that the **Recording** function is enabled.
2. Click **Edit**.

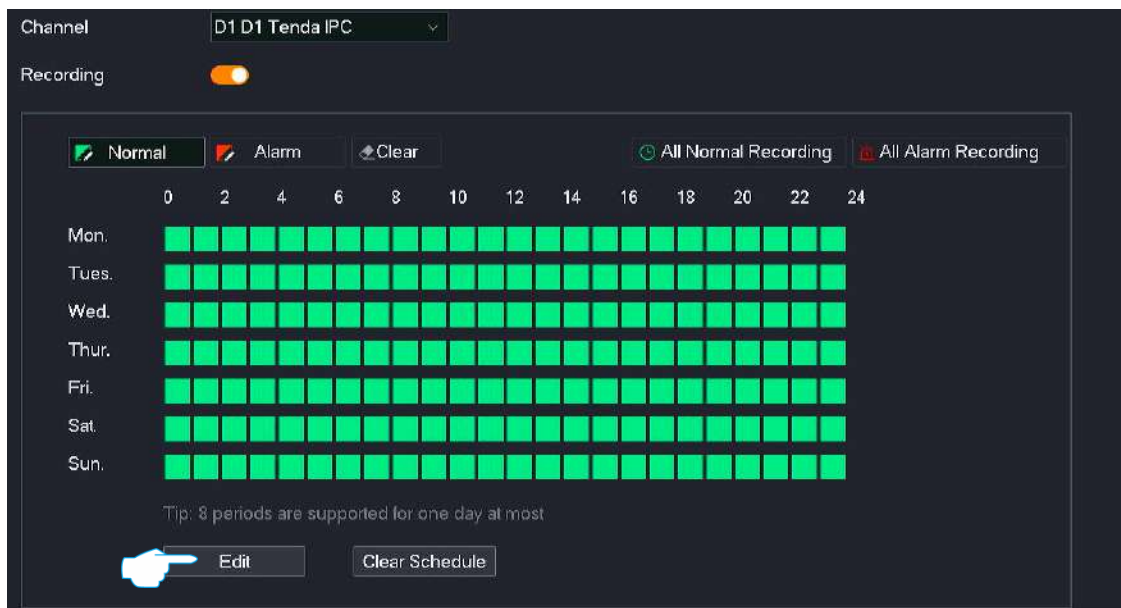

3. Set the schedule for **Monday** according to the schedule, as shown in the following figure. Then click **Copy to**.

Dialog: Edit

Mon. | Tues. | Wed. | Thur. | Fri. | Sat. | Sun.

Period	Recording Type
08:00 - 12:00	Alarm
12:00 - 14:00	Normal
14:00 - 18:00	Alarm
18:00 - 24:00	Normal
00:00 - 00:00	Normal
00:00 - 00:00	Normal
00:00 - 00:00	Normal
00:00 - 00:00	Normal

Copy to

Cancel Save

4. Tick **All**, and click **Save**. Return to the **Edit Schedule** page, and click **Save**.

Dialog: Copy to

All

Mon. Tues. Wed. Thur.

Fri. Sat. Sun.

Cancel Save

Step 4 Set the schedule of other channel cameras.

Click **Sync to** at the bottom of the page, and select the channel to synchronize the image parameter configuration of the D1 camera, which is **D2** to **D4** in this example.

Step 5 Click **Save**.

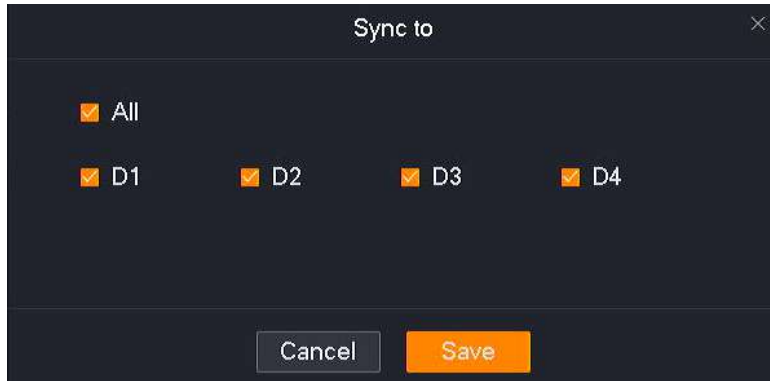

---End

After the setting completes, the system will enable the D1, D2, D3 and D4 cameras to record according to the above schedule.

4.6.4 Alarm Management

On the alarm management page, you can configure alarm events and the related information. If an alarm is triggered within the arming schedule, the system will alarm and record according to the linkage action you set.

Motion Detection



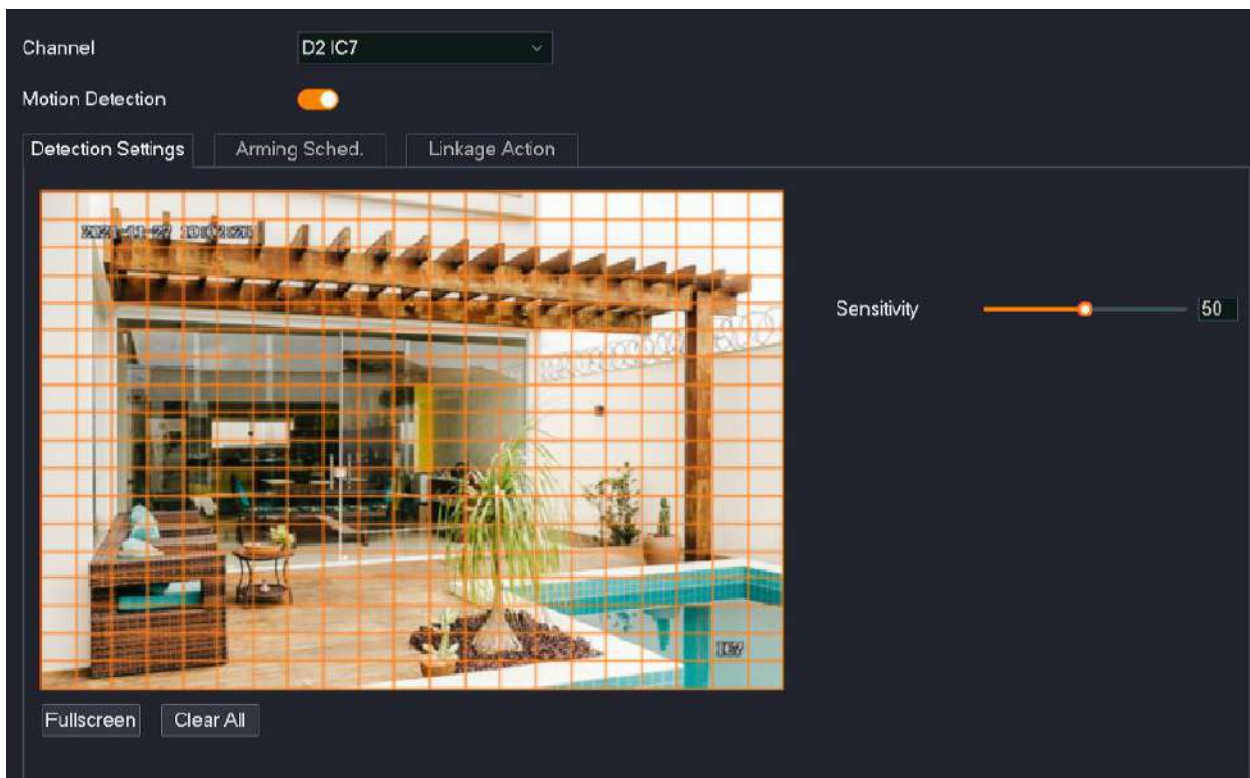

Overview

Navigate to **Configuration > Alarm > Motion Detection**.

Motion detection refers to the detection and alarm of moving targets. When a moving target appears on the monitoring image and the moving sensitivity reaches the preset value, the system will alarm and record according to the linkage action you set.

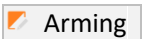

Parameter & button description

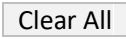
Parameter	Description
Channel	It specifies the channel chosen to set the schedule.
Motion Detection	It specifies whether the motion detection function is enabled.
Detection Settings	It specifies the detection type.
	Smart Detection By default, the movement of all objects is detected. After Human Detection is enabled, the system will be alarmed only when a human is detected.
	Sensitivity It specifies the detection sensitivity threshold that triggers an alarm. The larger the value, the easier it is to trigger an alarm.
	 Fullscreen It is used to one-click to set all areas as the detection area.
	 Clear All It is used to clear the current detection area.
Arming Sched.	It is used to set an arming schedule.
	 Arming Click this button to draw the motion detection time in the timetable below.
	It is used to clear the time that has been set in the timetable below.
	 Clear Click this button to clear the motion detection time in the timetable below.
	 Edit It is used to edit the motion detection schedule of a specific time.
	 Clear All It is used to clear the current arming schedule.

Parameter	Description
Linkage Action	<p>It specifies the alarm method of the NVR after an alarm is triggered.</p> <ul style="list-style-type: none"> – Single Screen Display: The alarm channel is displayed on a single screen on the Live View page after an alarm is triggered. – Send Email: The system will send an alarm email to the preset receiver email after an alarm is triggered. You need to set the relevant parameters of email for this alarm method to take effect. Please refer to Email Configuration for details.
	<ul style="list-style-type: none"> – Message Notification: The system will send an alarm notification to TDSEE App after an alarm is triggered. The NVR needs to be added successfully through TDSEE App. Please refer to Manage the NVR through TDSEE App for details. – Audio Alarm (Camera): The camera of the alarm channel will alarm through the audio after an alarm is triggered. – Light Alarm (Camera): The camera of the alarm channel will alarm through the supplement light after an alarm is triggered.
Recording Linkage	<p>It specifies the system enables the selected channel to record after an alarm is triggered.</p> <p> NOTE</p> <p>Please ensure that a schedule has been set for the channel of the arming schedule.</p>

Configure Motion Detection Alarm

Scenario: Assume that you have set up a monitoring network with an NVR, installed four cameras and bound D1 to D4 respectively.

Requirement: The motion detection function is enabled for all cameras at 8:00 to 22:00 from Monday to Friday. When a human detection alarm is triggered, an alarm notification is pushed to the TDSEE app, an email is sent to the designated recipients, and trigger the corresponding channel for recording.

Solutions: Configure the **Motion Detection** and **Email Configuration** functions to meet this requirement.

Assume that:

- SMTP server address: smtp.gmail.com
- SMTP service port: 465
- Sender email address: Tom@gmail.com

- Encryption mode: SSL
- Recipient email address: Jerry@gmail.com

Procedures:

Step 1 [Log in to the GUI of the NVR.](#)

Step 2 Set the motion detection.

1. Navigate to **Configuration > Alarm > Motion Detection.**
2. Set the motion detection function of the camera D1.
 - (1) Set **Channel**, which is **D1** in this example, and ensure that the **Motion Detection** is enabled.
 - (2) Use the mouse to draw the detection area (by default, all monitoring area of the camera has been set as the detection area), and adjust the sensitivity as required.

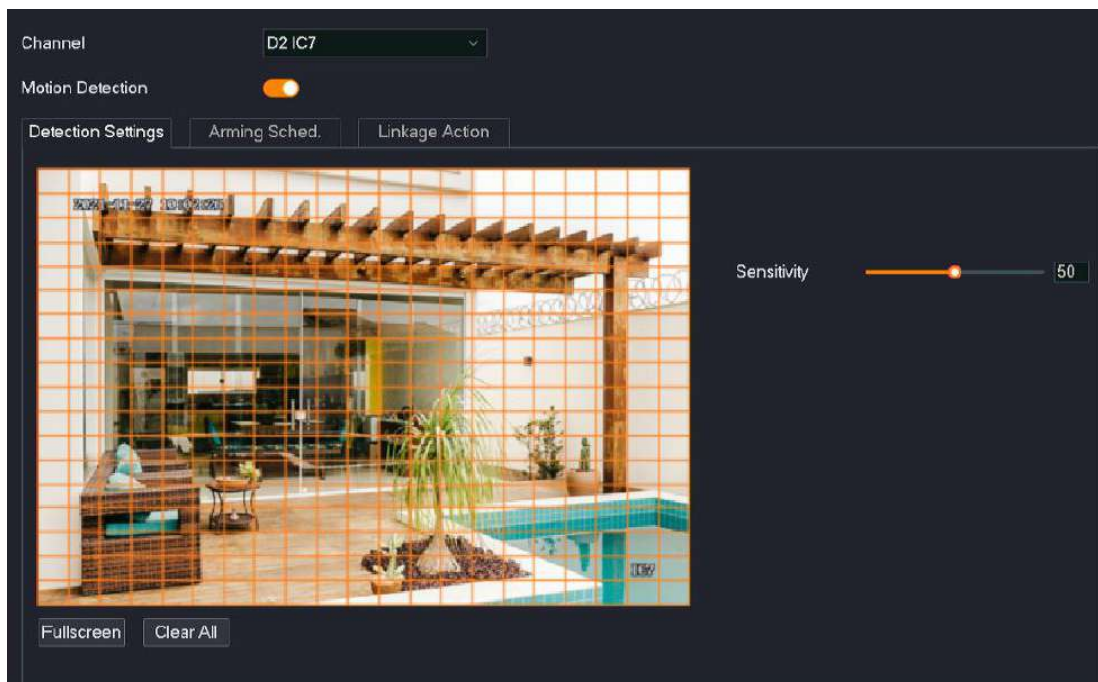

3. Set the motion detection of other channel cameras.

Click **Sync to** at the bottom of the page, and select the channels to synchronize the motion detection function of the D1 camera, which is **D2 to D4** in this example.

4. Click **Save**.

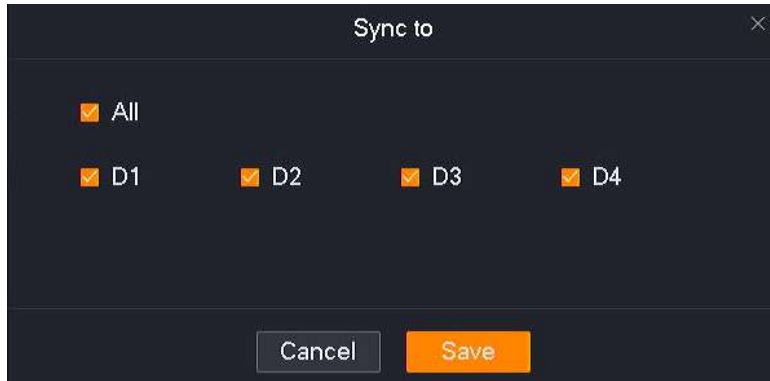

5. Set arming schedule.

- (1) Set arming schedule of the camera D1.

Click **Alarming Sched.**, and set the motion detection schedule, which is **8:00 to 20:00** from **Monday to Friday** in this example.

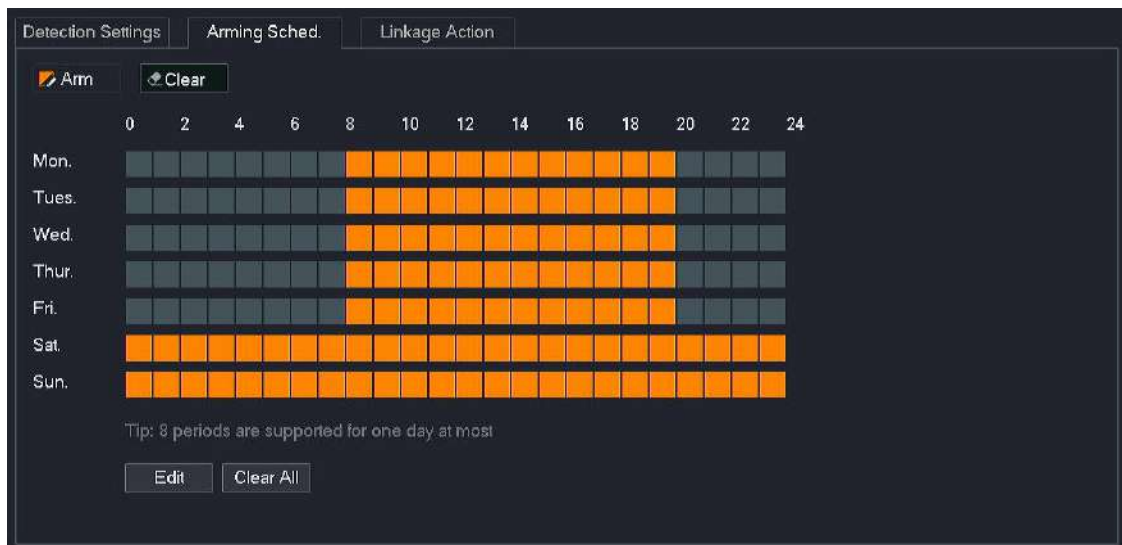

- (2) Set the alarming schedule of other channel cameras.

Click **Sync to** at the bottom of the page, and select the channels to synchronize the **Alarming Sched.** of the D1 camera, which is **D2** to **D4** in this example.

- (3) Click **Save**.

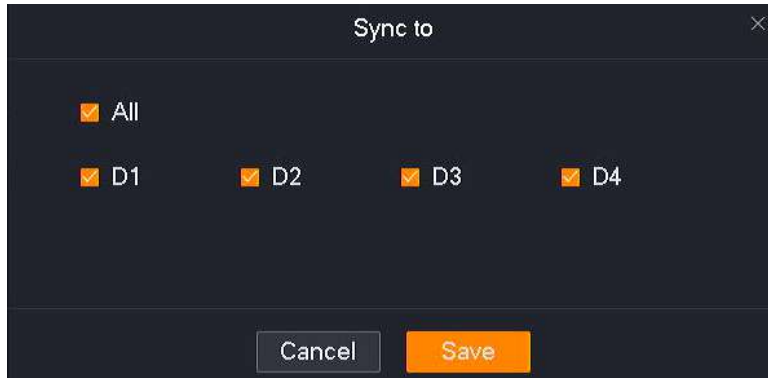

6. Set the linkage action.

- (1) Set the linkage action of the camera D1.

Click **Linkage Action**, and select alarm methods, which are **Send Email** and **Message Notification** in this example. Then select the recording channel, which is **D1** in this example.

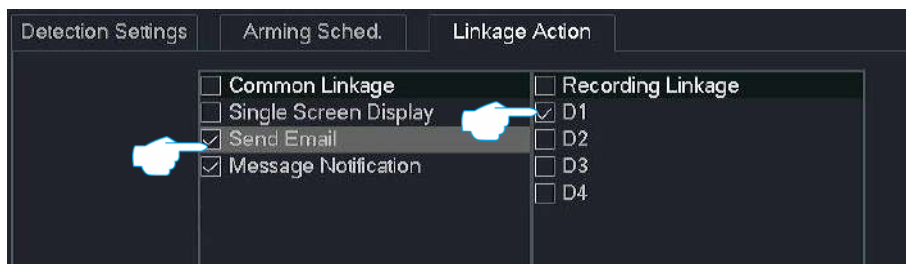

- (2) Set the linkage action of other channel cameras.

Click **Sync to** at the bottom of the page, and select the channels to synchronize the **Linkage Action** of the D1 camera, which is **D2** to **D4** in this example.

- (3) Click **Save**.

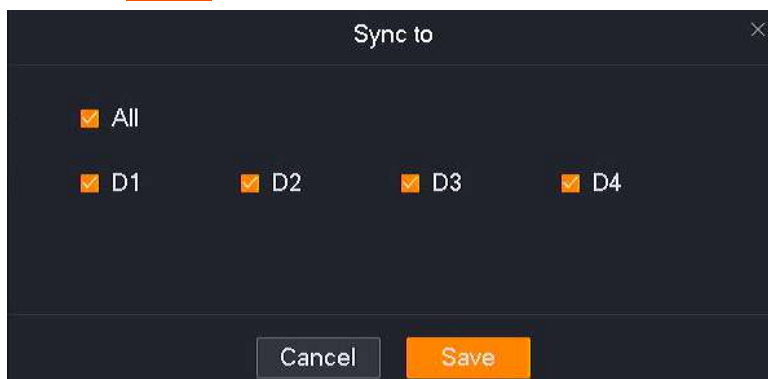

Step 3 Set email alarm function. Refer to [Configure Email Alarm](#) for the related steps.

No.	Recipient Name	Recipient Email	Test
1	Jerry	Jerry@gmail.com	Test
2	Custom recipient name	Recipient Email address	Test
3	Custom recipient name	Recipient Email address	Test

Step 4 Use TDSEE App to add the NVR. Refer to [Manage the NVR Through TDSEE App](#) for the related steps. (If set, please skip.)

---End

After the setting completes, if the system detects an alarm from D1 to D4, it will push an alarm notification and image to the TDSEE App, send emails to the designated recipients, and trigger the corresponding channel to record at the same time.

Exception Detection

Overview

Navigate to **Configuration > Alarm > Exception Detection**.

Exception detection refers to the detection and alarm of exception events. When an exception event occurs, the system will be alarmed according to the linkage action you set.

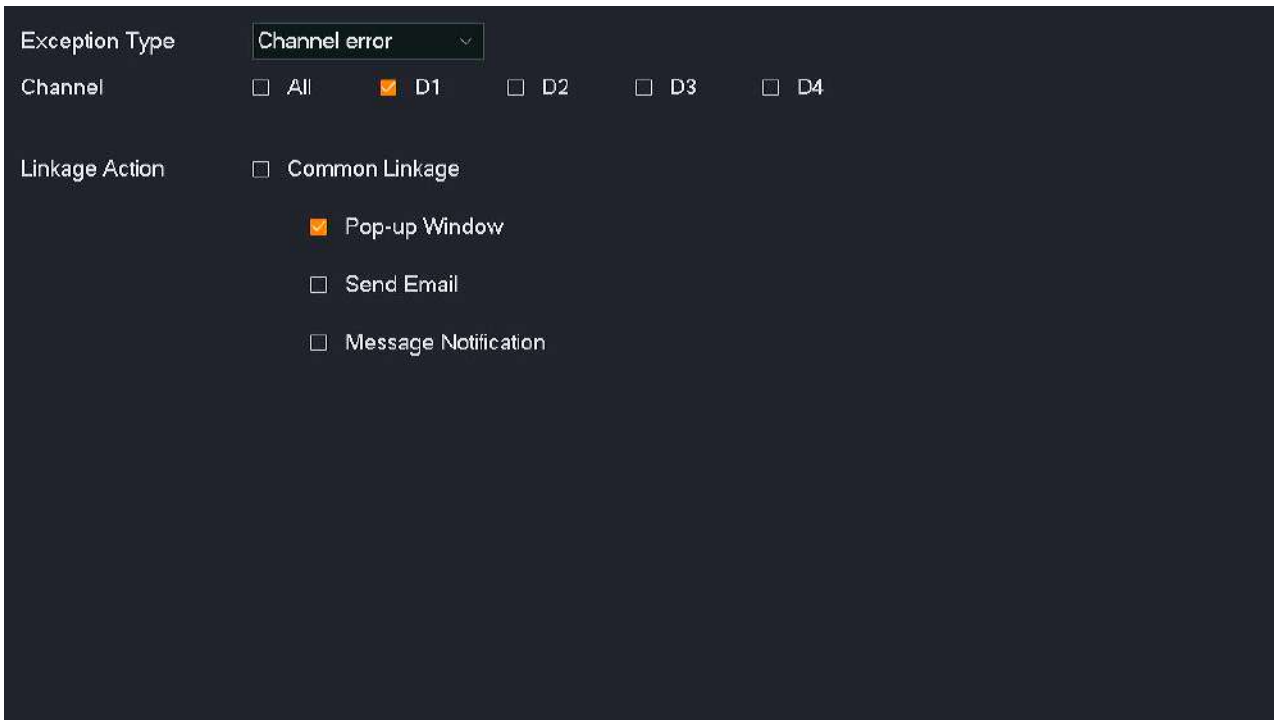

The screenshot shows a configuration panel for Exception Detection. It features a dark background with white text and controls. The 'Exception Type' is set to 'Channel error' in a dropdown menu. Under the 'Channel' section, there are five radio button options: 'All', 'D1', 'D2', 'D3', and 'D4'. The 'D1' option is selected. Under the 'Linkage Action' section, there are four radio button options: 'Common Linkage', 'Pop-up Window', 'Send Email', and 'Message Notification'. The 'Pop-up Window' option is selected.

Exception Type	Channel error
Channel	<input type="checkbox"/> All <input checked="" type="checkbox"/> D1 <input type="checkbox"/> D2 <input type="checkbox"/> D3 <input type="checkbox"/> D4
Linkage Action	<input type="checkbox"/> Common Linkage <input checked="" type="checkbox"/> Pop-up Window <input type="checkbox"/> Send Email <input type="checkbox"/> Message Notification

Parameter description

Parameter	Description
Exception Type	<p>It specifies the exception type of alarm detection that is supported by the NVR.</p> <ul style="list-style-type: none"> – No HDD: When the HDD is not detected, the system will alarm according to the corresponding linkage action. – HDD error: When an error of HDD (such as a read-write error) is detected, the system will alarm according to the corresponding linkage action. – HDD space is not enough: When the HDD space is less than 20%, the system will alarm according to the corresponding linkage action. – Channel error: When a channel error is detected, the system will alarm according to the corresponding linkage action. – Disconnected from the internet: When the Ethernet cable is not connected to the LAN port or not plugged in tight, the system will alarm according to the corresponding linkage action. – IP address conflict: When an IP address conflict is detected in the LAN, the system will alarm according to the corresponding linkage action. – Unauthorized access: When the number of failed password entry attempts has reached the upper limit, the system will alarm according to the corresponding linkage action.
Channel	<p>It is available only when Exception Type is set to Channel error.</p> <p>It specifies the channel chosen to set the Channel error alarm.</p>
Linkage Action	<p>It specifies the alarm mode of the NVR after an alarm is triggered. The alarm mode of each Exception Type is set independently, and the supported alarm modes are different. The actual page prevails.</p> <ul style="list-style-type: none"> – Pop-up Window: After an alarm is triggered, an alarm notification will be displayed in a pop-up window on the Live View page. – Send Email: After an alarm is triggered, the system will send an alarm email to the preset Recipient email. You need to set the relevant parameters of email for this alarm method to take effect. Please refer to Email Configuration for details. – Message Notification: After an alarm is triggered, the system will send an alarm notification to TDSEE App. The NVR needs to be added successfully through TDSEE App. Please refer to Manage the NVR through TDSEE App for details.

Configure Exception Detection Alarm

Scenario: Assume that you have set up a monitoring network with the NVR, and the camera D1 is installed at the door.

Requirement: When the system detects the channel is abnormal and the LAN port connection is abnormal of the NVR, it will alarm through a pop-up window. When the system detects unauthorized access, it will push an alarm notification to TDSEE App.

Solutions: The **Exception Detection** function can meet this requirement.

Procedures:

Step 1 [Log in to the GUI of the NVR.](#)

Step 2 Navigate to **Configuration > Alarm > Exception Detection.**

Step 3 Set alarm mode of the channel error.

1. Set **Exception Type**, which is a **Channel error** in this example.
2. Select the channel for exception detection, which is **D1** in this example.
3. Select alarm mode, which is **Pop-up Window** in this example.

The screenshot shows the configuration interface for Exception Detection. The 'Exception Type' is set to 'Channel error'. Under the 'Channel' section, 'D1' is selected with a checked checkbox, while 'All', 'D2', 'D3', and 'D4' are unchecked. Under the 'Linkage Action' section, 'Pop-up Window' is selected with a checked checkbox, while 'Common Linkage', 'Send Email', and 'Message Notification' are unchecked.

Step 4 Set alarm mode of LAN port connection error of the NVR.

1. Set **Exception Type**, which is **Disconnected from the internet** in this example.
2. Select alarm mode, which is **Pop-up Window** in this example.

The screenshot shows the configuration interface for Exception Detection. The 'Exception Type' is set to 'Disconnected from the internet'. Under the 'Linkage Action' section, both 'Common Linkage' and 'Pop-up Window' are selected with checked checkboxes.

Step 5 Set alarm mode of unauthorized access.

1. Set **Exception Type**, which is **Unauthorized access** in this example.
2. Select alarm mode, which is **Message Notification** in this example.

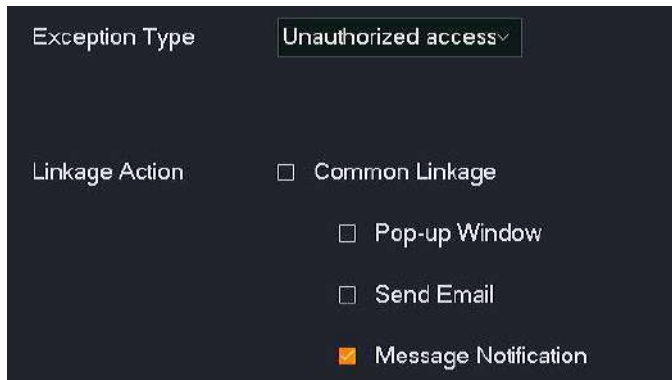

The screenshot shows a configuration window with a dark background. At the top, there is a label 'Exception Type' followed by a dropdown menu showing 'Unauthorized access'. Below this, there is a label 'Linkage Action' followed by four options, each with a checkbox: 'Common Linkage' (unchecked), 'Pop-up Window' (unchecked), 'Send Email' (unchecked), and 'Message Notification' (checked with an orange square).

Step 6 Click **Save** at the bottom of the page.

Step 7 Manage the NVR through TDSEE App. Please refer to [Manage the NVR through TDESS App](#) for details.

---End

After the setting completes, when the system detects that D1 is abnormal and the LAN port connection of the NVR is abnormal, it will alarm through a pop-up window. When the system detects unauthorized access, it will push an alarm notification to TDSEE App.

4.6.5 Network Configuration

On the network configuration page, you can configure the NVR to access the internet, enable cloud service, modify the Wi-Fi network, check the connected Wi-Fi cameras and enable an email alarm.

Internet Settings

Navigate to **Configuration > Network > Internet**.

You can view the LAN port parameters of the NVR, and can also modify the LAN port parameters to enable the NVR to access the internet.

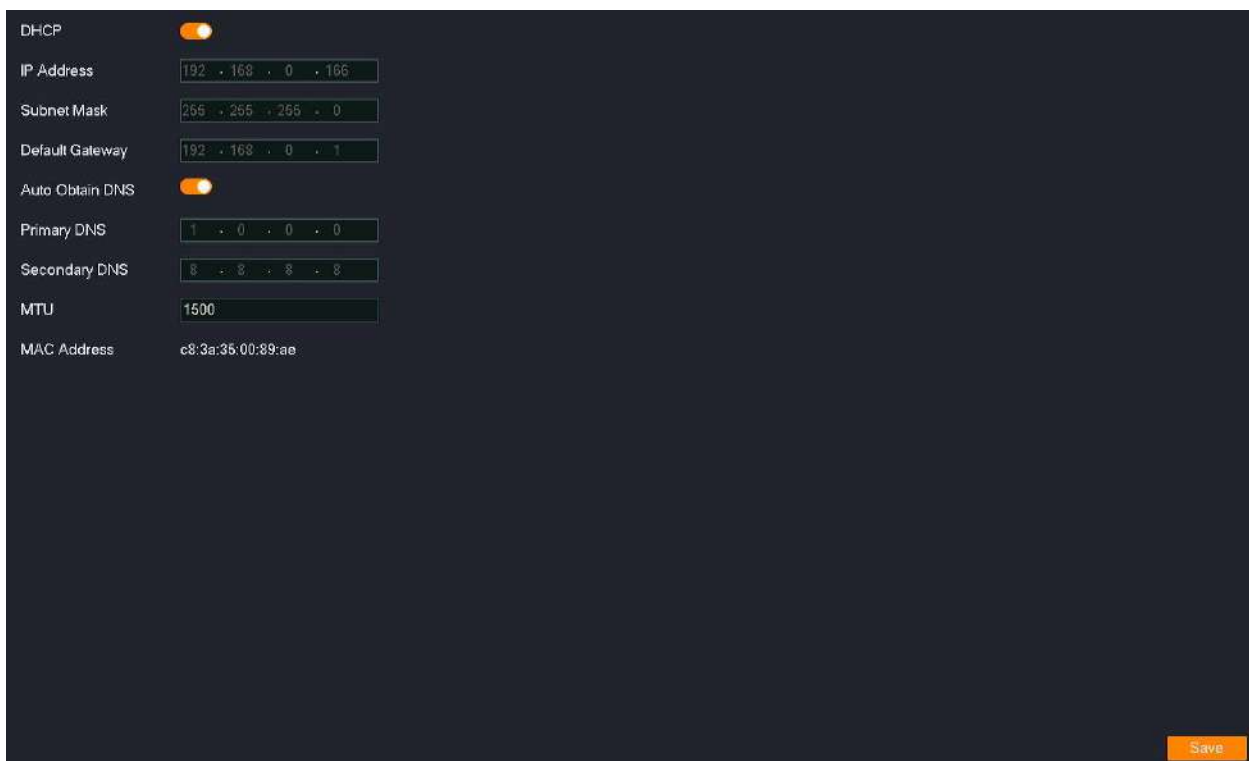



The screenshot displays the 'Internet Settings' configuration page for an NVR. The interface is dark-themed with white text. The settings are as follows:

DHCP	<input checked="" type="checkbox"/>
IP Address	192 . 168 . 0 . 166
Subnet Mask	255 . 255 . 255 . 0
Default Gateway	192 . 168 . 0 . 1
Auto Obtain DNS	<input checked="" type="checkbox"/>
Primary DNS	1 . 0 . 0 . 0
Secondary DNS	8 . 8 . 8 . 8
MTU	1500
MAC Address	c8:3a:35:00:89:ae

A 'Save' button is located in the bottom right corner of the configuration area.

Parameter description

Parameter	Description
DHCP	<p>It specifies whether to enable the function of the NVR automatically obtaining an IP address from an upstream device.</p> <p>After the DHCP is enabled, the NVR can automatically obtain its IP address, subnet mask, default gateway and DNS server from the DHCP server in the network.</p> <p> TIP</p> <p>If the DHCP is disabled, you need to manually configure an IP address, subnet mask, default gateway and DNS server for NVR.</p>
IP Address	<p>It specifies the IP address of the NVR.</p> <p>To connect the NVR to the internet, the IP address of the NVR must be set in the same network segment of the LAN IP address of the router with internet connectivity.</p>
Subnet Mask	It specifies the subnet mask of the NVR.
Default Gateway	<p>It specifies the default gateway of the NVR.</p> <p>To connect the NVR to the internet, the IP address of the NVR must be set in the default gateway of the LAN IP address of the router with internet connectivity.</p>
Auto Obtain DNS	<p>It specifies whether to enable the function of the NVR automatically obtaining DNS from an upstream device.</p> <p>After the Auto Obtain DNS function is enabled, the NVR can automatically obtain its DNS from the DHCP server in the network.</p> <p> TIP</p> <p>If the Auto Obtain DNS is disabled, you need to manually configure primary DNS and secondary DNS for NVR.</p>
Primary DNS	They specify the primary or secondary DNS server address of the NVR.
Secondary DNS	If the router with internet connectivity has a DNS proxy function, the Primary DNS address can be set to the IP address of the LAN port of the router with internet connectivity.
MTU	It specifies the largest data packet transmitted by the NVR, that is, the maximum transmission unit.
MAC Address	It specifies the LAN MAC address of the NVR.

Cloud Service



Overview

Navigate to **Configuration > Network > Cloud Service**.

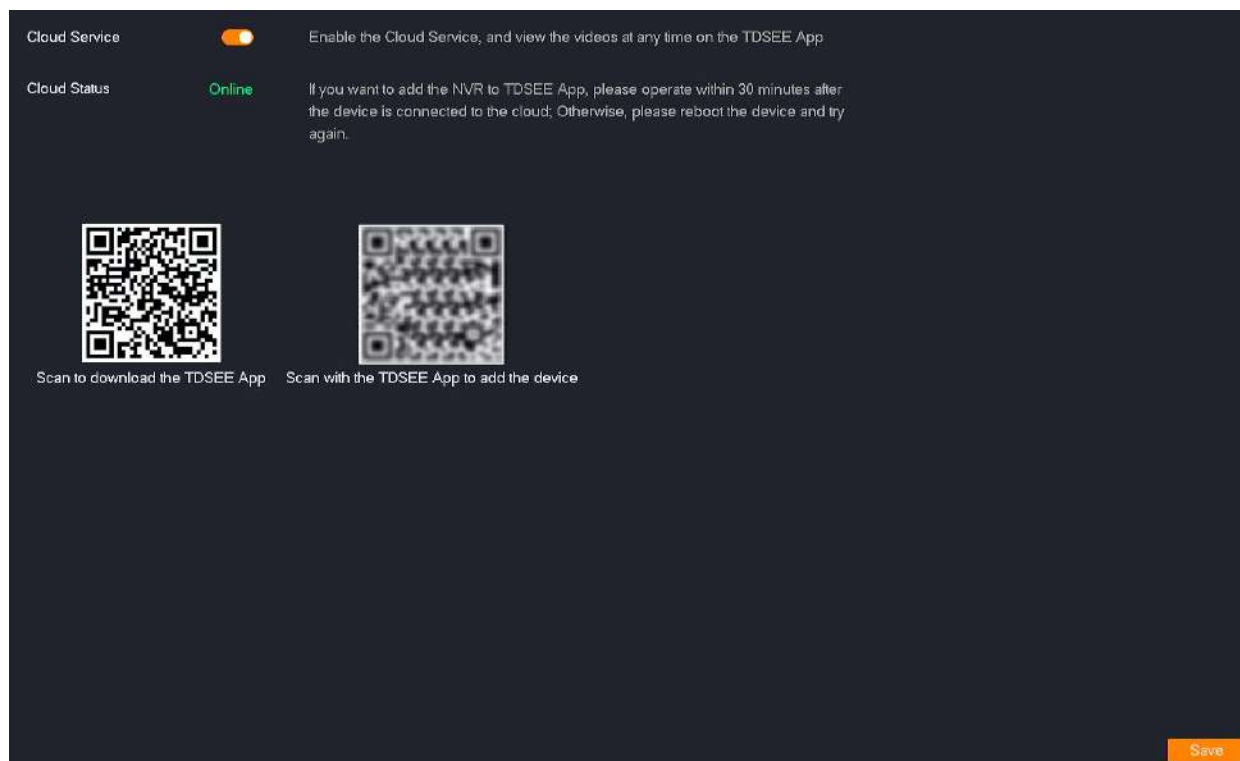
The cloud service function enables the NVR to connect to the cloud, and you can add the NVR through TDSEE App to preview monitoring videos remotely, play back history recordings and view alarm notifications.



Parameter description

Parameter	Description
Cloud Service	<p>It specifies whether to enable the cloud service function.</p> <p> TIP</p> <p>Disabling the cloud service requires rebooting the NVR to enable the settings.</p>
Cloud Status	<p>It specifies the status of the NVR connected to the cloud.</p> <p>If the cloud status displays Offline, move the mouse to  on the upper of the page, then follow the on-screen instructions.</p>

Manage the NVR Through TDSEE App

Assume that you have set up a monitoring network with the NVR, now you want to remotely manage the NVR and monitor the network through TDSEE App.

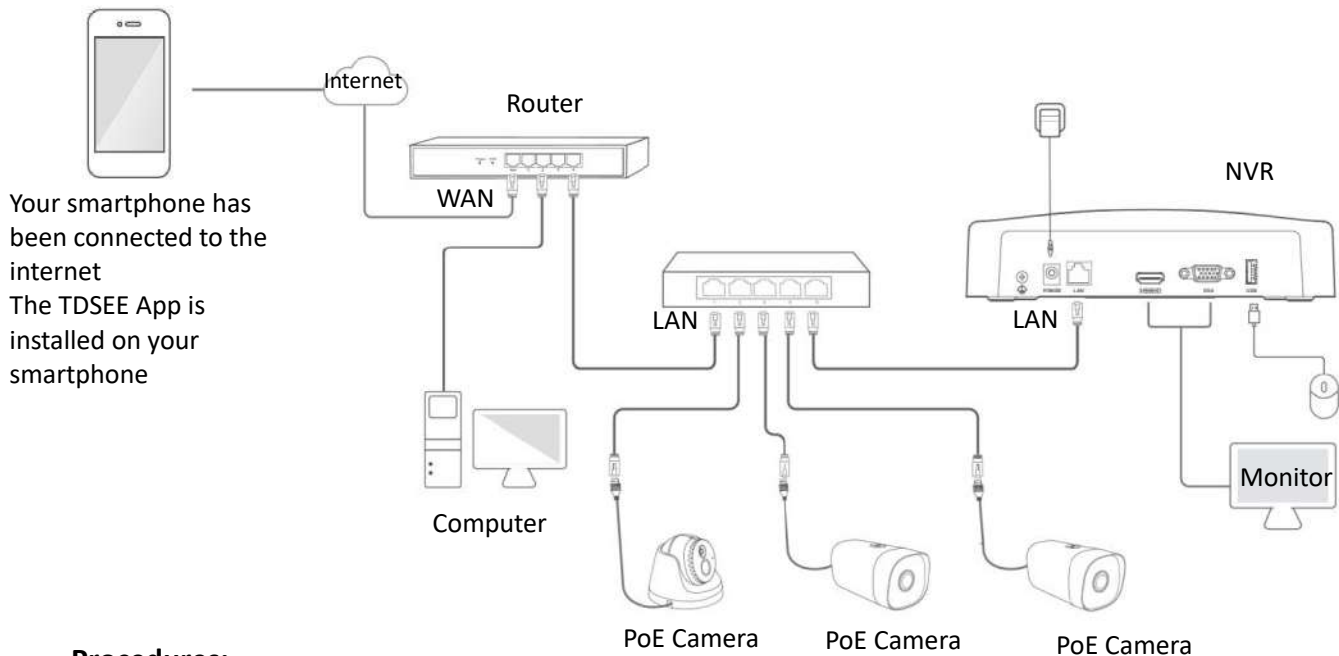

Procedures:

Step 1 Configure the NVR.

1. [Log in to the GUI of the NVR.](#)
2. Configure the cloud service function of the NVR.

Navigate to **Configure > Network > Cloud Service**, enable the **Cloud Service** function, and ensure that the **Cloud Status** is **Online**.

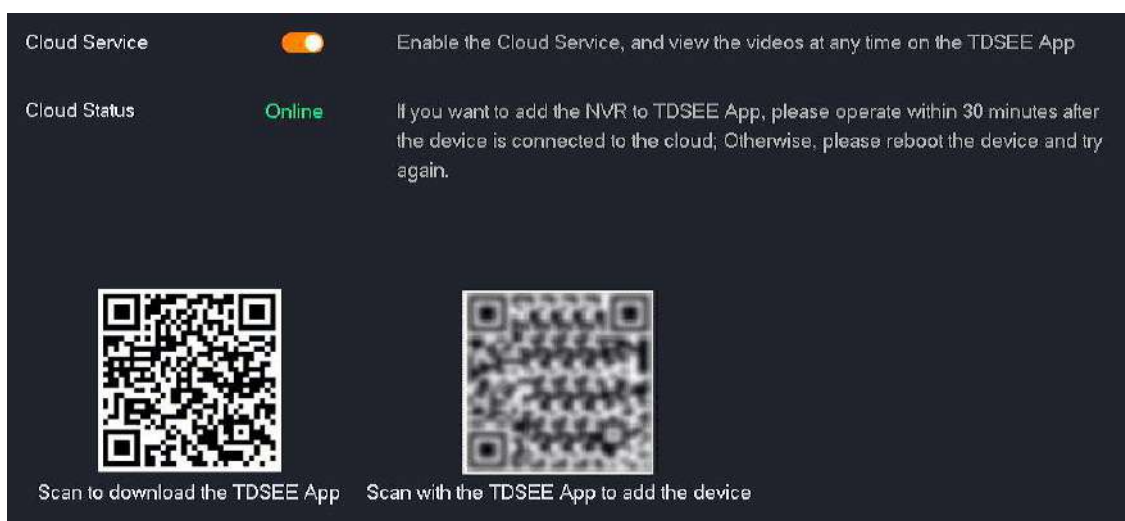

If the cloud status is **Offline**, please try the following solutions:

- Ensure that the router is connected to the internet in the network and the DHCP function is disabled.
- Ensure that the LAN port of the NVR is connected to the peer side (router or switch) correctly and securely.
- Ensure that the LAN [DHCP](#) function of the NVR is enabled.

Step 2 Download and register the TDSEE App. (If you have registered, skip this step.)

1. After the smartphone is connected to the internet successfully, download and install the TDSEE App onto your smartphone by scanning the QR code below or by searching for TDSEE in the Google Play or App Store.



Scan the code to download TDSEE App

2. Run the TDSEE App.



TDSEE

3. Tap **Register**, and follow the instructions to complete user registration. You can authorize the TDSEE App to use a third-party account to log in.



To ensure that the login password of the NVR can be reset through TDSEE App, please register with the email address you used to activate the NVR.

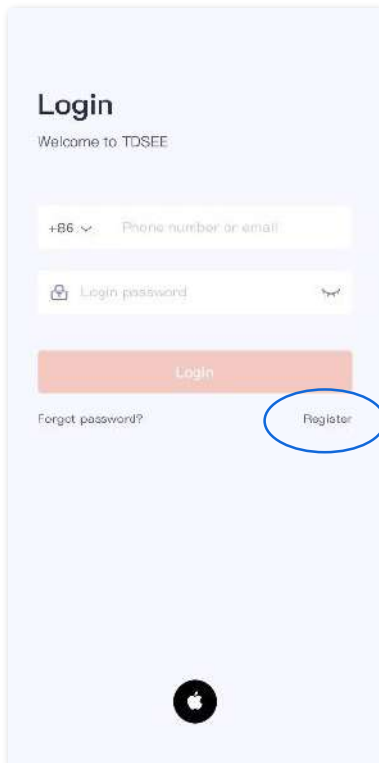

Step 3 Add the NVR on TDSEE App.



Ensure that the NVR is powered on and working properly.

1. Enter the **Home** page, and tap **Add a device** or  in the upper-right corner.



2. Scan the related QR code on the label at the bottom of the NVR or scan the QR code on the **Cloud Service** page, then follow the instructions in the App.

---End

After the setting completes, you can remotely preview real-time videos, play back the recordings and check alarm notifications through TDSEE App.

Wi-Fi Configuration

The N3W-4H is taken as an example here.

Wi-Fi Network

Navigate to **Configuration > Network > Wi-Fi > Wi-Fi Network**.

You can modify the Wi-Fi parameters of the NVR, such as Wi-Fi name, Wi-Fi password and channel.

Parameter description

Parameter	Description
Wi-Fi Network	<p>It specifies whether to enable the Wi-Fi network of the NVR.</p> <p> NOTE Disabling the Wi-Fi network will affect the connection of the Wi-Fi camera. Please operation with caution.</p>
Wi-Fi Name	It specifies the Wi-Fi name of the NVR.
Security Mode	It specifies the encryption mode of the NVR.
Wi-Fi Password	It specifies the Wi-Fi password of the NVR.
Region/Country	It specifies the country or region where the NVR is located.

Parameter	Description
Channel	It specifies the operating channel of the Wi-Fi network. The NVR is operating on a specific channel by default. You can modify the channel if the monitoring video is not smooth or the camera frequently goes online and offline.
Network Mode	It specifies the wireless transmission protocol.
Bandwidth	It specifies the bandwidth of the wireless channel.
IP Address	It specifies the IP address of the wireless interface and it cannot be changed.
MAC Address	It specifies the MAC address of the wireless interface.

Connected Camera

Navigate to **Configuration > Network > Wi-Fi > Connected Camera**.

You can view the related information of the Wi-Fi camera currently connected to the NVR, including IP address, MAC address, wireless speed, and uptime.

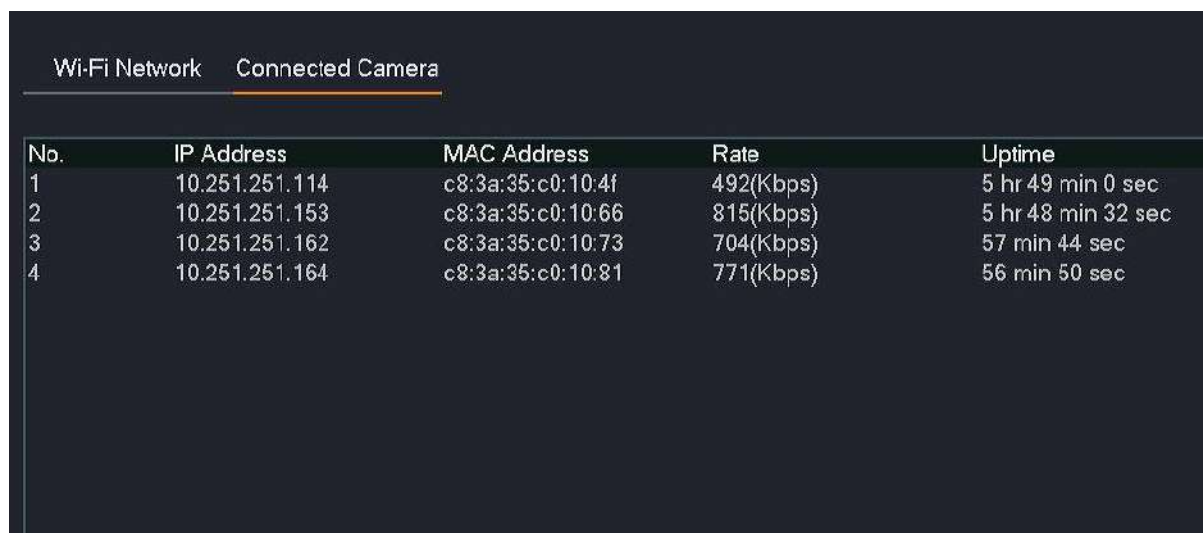

No.	IP Address	MAC Address	Rate	Uptime
1	10.251.251.114	c8:3a:35:c0:10:4f	492(Kbps)	5 hr 49 min 0 sec
2	10.251.251.153	c8:3a:35:c0:10:66	815(Kbps)	5 hr 48 min 32 sec
3	10.251.251.162	c8:3a:35:c0:10:73	704(Kbps)	57 min 44 sec
4	10.251.251.164	c8:3a:35:c0:10:81	771(Kbps)	56 min 50 sec

Parameter description

Parameter	Description
No.	It specifies the number of the camera.
IP Address	It specifies the IP address of the camera.
MAC Address	It specifies the MAC address of the camera.
Rate	It specifies the real-time wireless rate of the camera.

Parameter	Description
Uptime	It specifies the uptime of the camera that was last connected to the Wi-Fi of the NVR.

PoE Configuration

Navigate to **Configuration > Network > PoE**. The N6P-4H is taken as an example here.

You can view the connection status, power and IP address of the PoE port of the NVR, and can also switch the operating mode of the PoE port.

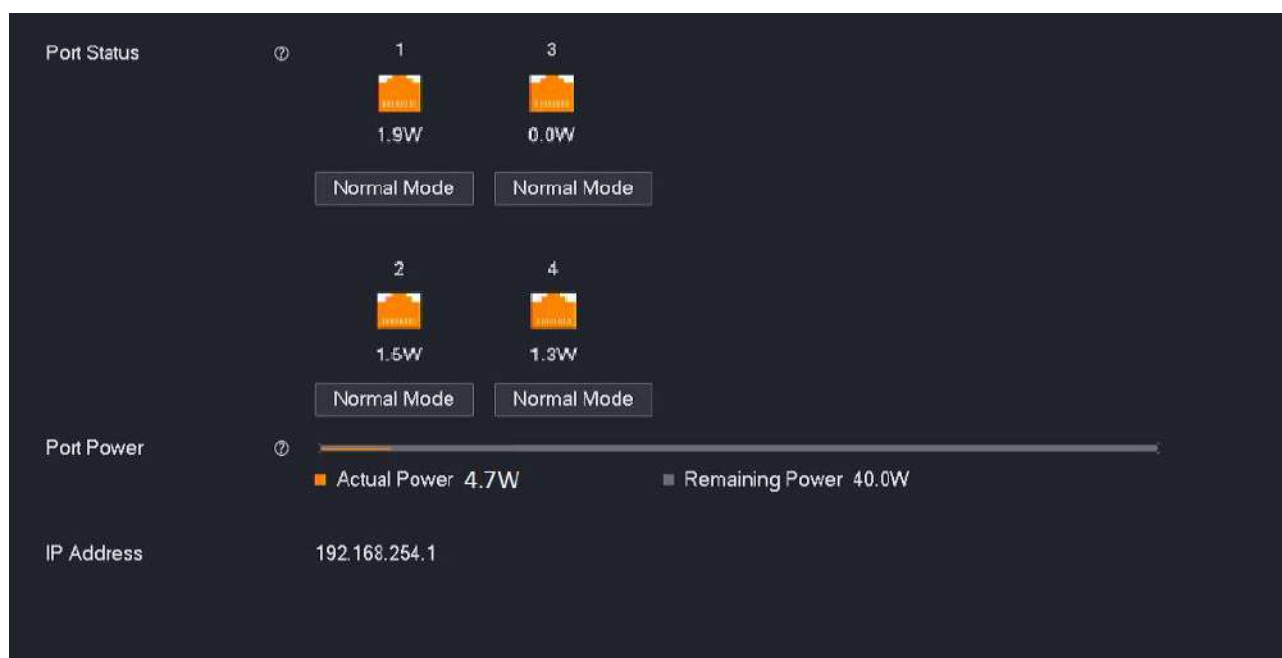

Parameter & button description

Parameter	Description
1, 2, 3, 4	It specifies the number of the PoE port of the NVR.
nW	It specifies the output power of the PoE port of the NVR.
Port Status	<p>It specifies the current operating mode of the PoE port of the NVR. Click it to switch the common mode to long-distance mode.</p> <p>Under normal mode, the maximum transmission distance is 100 m.</p>

Parameter	Description
Long-range Mode	It specifies the current operating mode of the NVR PoE port. Click it to switch the long-range mode to common mode. Under long-distance mode, the port rate is reduced to 10 Mbps, and the maximum transmission distance is 250 m
Port Power	Actual Power It specifies the output power of the current PoE power supply of the NVR.
	Remaining Power It specifies the remaining power of the PoE power supply of the NVR.
IP Address	It specifies the IP address of the PoE port of the NVR. The IP address cannot be modified.

Port Configuration

Navigate to **Configuration > Network > Port**.

The port number indicates different network services, for example, 443 port indicates HTTPS service. You can view or modify each service port number here.

The screenshot shows a configuration page with a dark background. At the top left, there are two labels: "HTTPS Port" and "WebSockets Port". To the right of "HTTPS Port" is a text input field containing the number "443". To the right of "WebSockets Port" is a text input field containing the number "9002". In the bottom right corner, there is an orange button labeled "Save".

Parameter description

Parameter	Description
HTTPS Port	<p>It specifies the port of the HTTPS protocol. You are recommended to keep the default settings.</p> <p>After the HTTPS port number is modified, when you log in to the web UI of the camera, you can manually enter this port number behind the IP address of the camera. The access format is HTTPS://camera IP address: HTTPS port.</p>
WebSockets Port	<p>It specifies the port of the WebSockets protocol. You are recommended to keep the default settings.</p> <p>You can realize two-way communication between the browser and the server, and allow the server to push data to the browser through WebSockets protocol.</p>

Email Configuration

Overview

Navigate to **Configuration > Network > Email**.

The alarm linkage action of this NVR supports email alarm. If you want to receive an alarm notification through email, you need to configure the email alarm function first.

By default, this function is disabled. When it is enabled, the page is shown as below.

Email Alarm Service

SMTP Server

SMTP Port

Anonymous

Sender

Sender Email



Password

Encryption Mode

Image Attachment

No.	Recipient Name	Recipient Email	Test
1	<input type="text" value="Custom recipient name"/>	<input type="text" value="Recipient Email address"/>	<input type="button" value="Test"/>
2	<input type="text" value="Custom recipient name"/>	<input type="text" value="Recipient Email address"/>	<input type="button" value="Test"/>
3	<input type="text" value="Custom recipient name"/>	<input type="text" value="Recipient Email address"/>	<input type="button" value="Test"/>

Parameter description

Parameter	Description	
Email Alarm Service	It specifies whether to enable the email alarm service function.	
SMTP Server	It specifies the SMTP server address and supports the IP address and domain address.	
SMTP Port	It specifies the SMTP server port.  After the encryption is enabled (SSL or TLS), the SMTP server port will be changed, users need to check and fill by themselves.	
Anonymous	It specifies whether to enable the Anonymous function. When it is enabled, the configuration of the sender information is not required, including sender name and sender email information.  This function is only available when the SMTP server address supports sending anonymous emails.	
Sender	It specifies the sender's name. You can custom it as required.	
Sender Email	It specifies the email account that sends the email.	
Password	It specifies the password corresponding to the email account of the sender.	
Encryption Mode	It specifies the encryption mode for mail transmission. <ul style="list-style-type: none"> – None: No encrypted transmission. – SSL: Secure Sockets Layer is a security protocol. It uses data encryption, identity verification, and message integrity verification mechanisms to provide security guarantees for network data transmission. – TLS: Transport Layer Security is a security protocol that provides security and data integrity for network communications. 	
Image Attachment	It specifies whether to send alarm pictures. After this function is enabled, when the system detects an alarm, it will send an alarming video and the captured picture at the same time.	
Recipient	No.	It specifies the number of the recipient.
	Recipient Name	It specifies the name of the recipient. You can custom it as required.
	Recipient	It specifies the email address of the recipient.

Parameter	Description
Email	
Test	It is used to test whether mail is sent and received normally.

Configure Email Alarm

Scenario: Assume that you have set up the monitoring network with NVR, and D1 to D4 have been connected to the camera.

Requirement: If there is a channel error in D1 to D4, such as **Camera offline**, an alarm notification will be pushed through email.

Solutions: Configure the **Exception Detection and Email Configuration** functions to meet this requirement.

- SMTP server address: smtp.gmail.com
- SMTP service port: 465
- Sender email address: Tom@gmail.com
- Encryption mode: SSL
- Recipient email address: Jerry@gmail.com

Procedures:



Please ensure that the NVR has connected to the internet successfully before configuring the email alarm.

Step 1 Enable the SMTP service of the sender's email. **Gmail** is taken as an example here. (If it is enabled, skip this step.)

1. Open the browser, and log in to your Gmail. Click  (**Settings**) in the upper-right corner → **See all settings**.

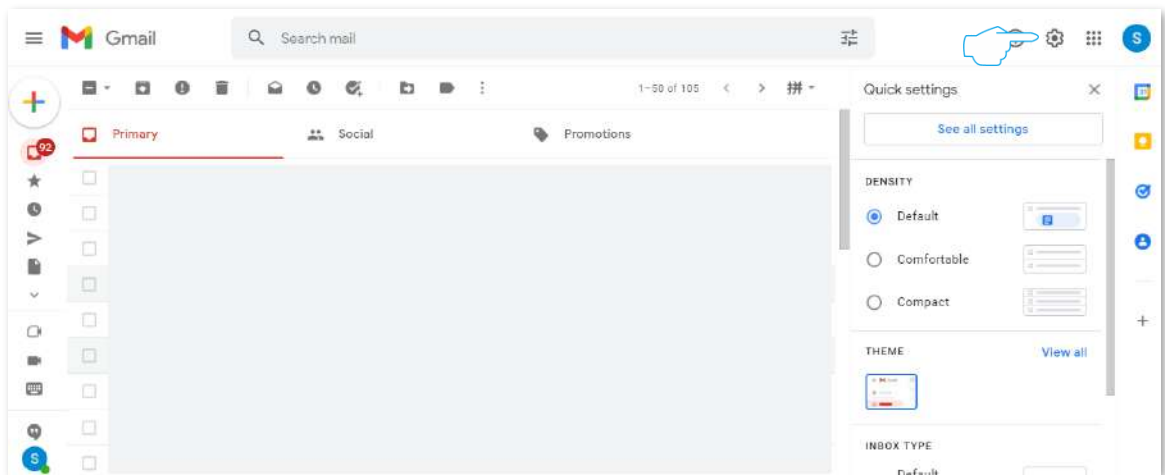

2. Click **Forwarding and POP/IMAP** on the settings page. Find **IMAP access**, tick **Enable IMAP**, and click **Save Changes** at the bottom of the page.

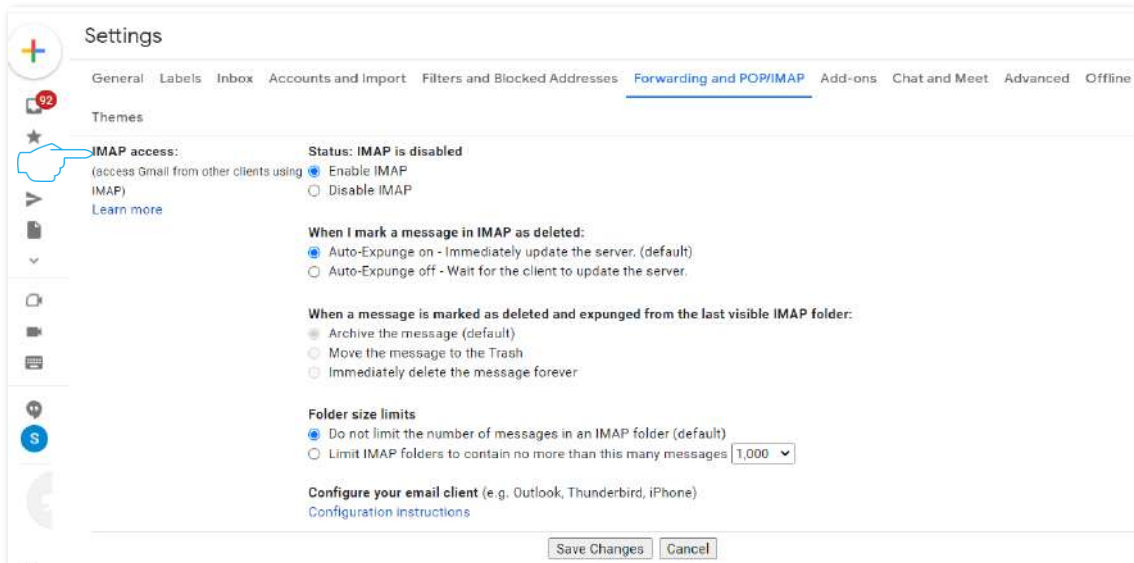

Step 2 Configure the NVR.

1. [Log in to the GUI of the NVR.](#)
2. When the channel is abnormal, you can set the linkage action.
 - (1) Navigate to **Configuration > Alarm > Exception Detection.**
 - (2) Set **Exception Type**, which is **Channel error** in this example.
 - (3) Select the channels for exception detection, which are **D1 to D4** in this example.
 - (4) Set **Linkage Action**, which is **Send Email** in this example.
 - (5) Click **Save** at the bottom of the page.

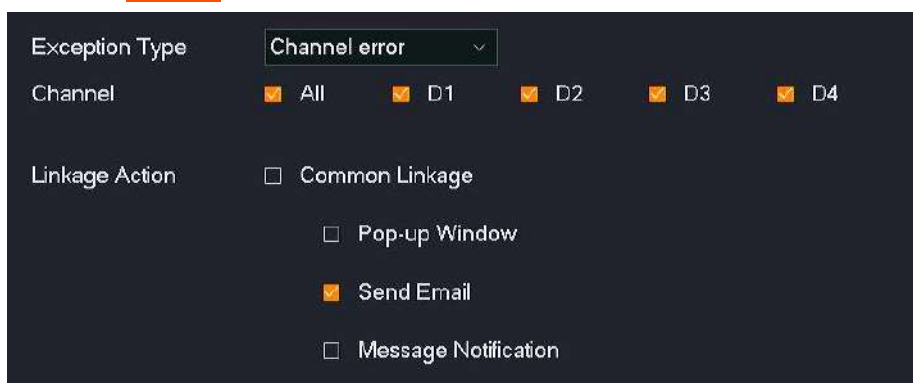

3. Configure the email alarm function.

- (1) Navigate to **Configuration > Network > Email**.
- (2) Enable the **Email Alarm Service** function.
- (3) Enter the SMTP server address, which is **smtp.gmail.com** in this example. Enter the SMTP server port, which is **465** in this example.
- (4) Set the name of the sender, which is **Tom** in this example. Enter the email address of the sender, which is **Tom@gmail.com** in this example.
- (5) Enter the login password of the Gmail of the sender. Click the icon  behind the input box to display the entered password.
- (6) Enable the **Image Attachment** function.
- (7) Set the name of the recipient, which is **Jerry** in this example. Enter the email address of the recipient, which is **Jerry@gmail.com** in this example.
- (8) Click **Test**.



If the test fails, try the following steps:

1. Please recheck the parameters you set in the NVR.
2. Log in to your Gmail, click **Accounts and Import** on the settings page, find **Change account settings**, and click **Other Google Account** settings.
3. Click **Security**, find less secure app access, and enable the **Turn on access** function.
- (9) Click **Save** at the bottom of the page.

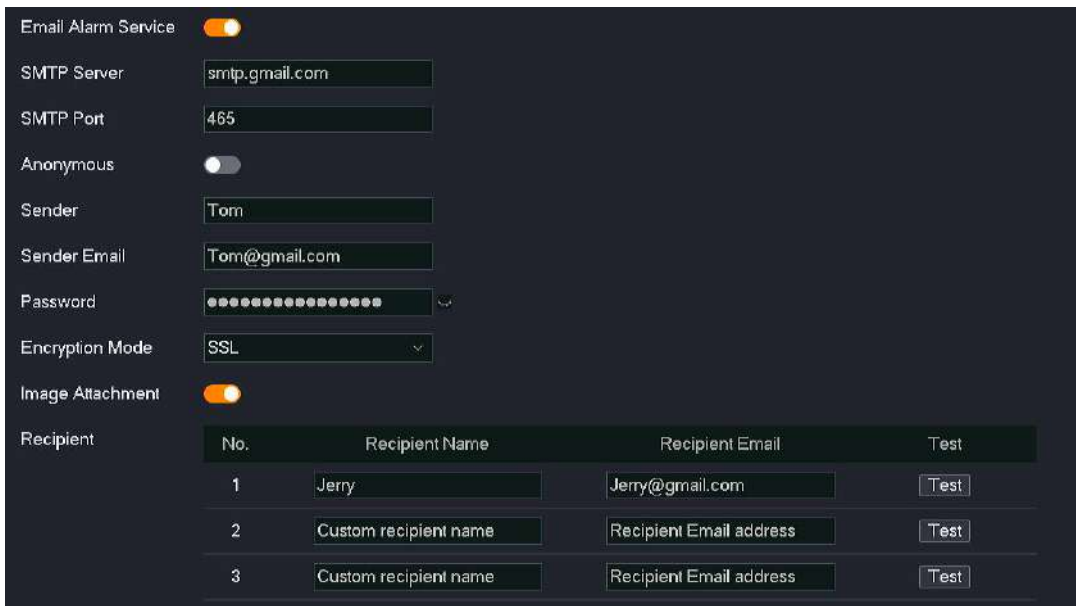

Email Alarm Service			
SMTP Server	smtp.gmail.com		
SMTP Port	465		
Anonymous	<input type="checkbox"/>		
Sender	Tom		
Sender Email	Tom@gmail.com		
Password	••••••••••••••••		
Encryption Mode	SSL		
Image Attachment	<input checked="" type="checkbox"/>		
Recipient	No.	Recipient Name	Recipient Email
	1	Jerry	Jerry@gmail.com
	2	Custom recipient name	Recipient Email address
	3	Custom recipient name	Recipient Email address

---End

After the setting completes, if there is a channel error in D1 to D4, an alarm notification will be pushed to the recipient through email.

DDNS

Overview

Navigate to **Configuration > Network > DDNS**.

Through the DDNS function, you can always map the dynamic IP address of the router (a public IP address) to a fixed domain name, so that internet users can access the router through this domain name.

DDNS

Connection Status: Disconnected

Service Provider: Oray DDNS

Server Address: ddns.oray.com

Domain Name: Get domain name at service

User Name: Registered user account at s

Password: Registered user password at s

Save

Parameter description

Parameter	Description
DDNS	It specifies whether to enable the DDNS function.
Connection Status	It specifies the connection status of the DDNS.
ISP	It specifies the ISP of the DDNS.
Server Address	It specifies the IP address of the DDNS. The system has preset the DDNS server address of the corresponding ISP.

Parameter	Description
Domain Name	It specifies the applied domain name on the website of the DDNS ISP.
User Name	It specifies the user name/password to log in to DDNS.
Password	The login user name and login password are registered on the website of the DDNS ISP.

Internet User Using the Domain Name to Access Web UI of the Camera

Scenario: Assume that you have set up a monitoring network with an NVR and connected to the internet.

Requirement: The user can access the web UI of the camera through the fixed domain name.

Solution: Configure the DDNS and UPnP functions to meet this requirement.

Assume that the related information of the registered DDNS service is as follows:

- ISP: Dyndns
- User name: Tom-Jerry
- Password: tomjerry123456
- Domain name: jointnet.dyndns.org

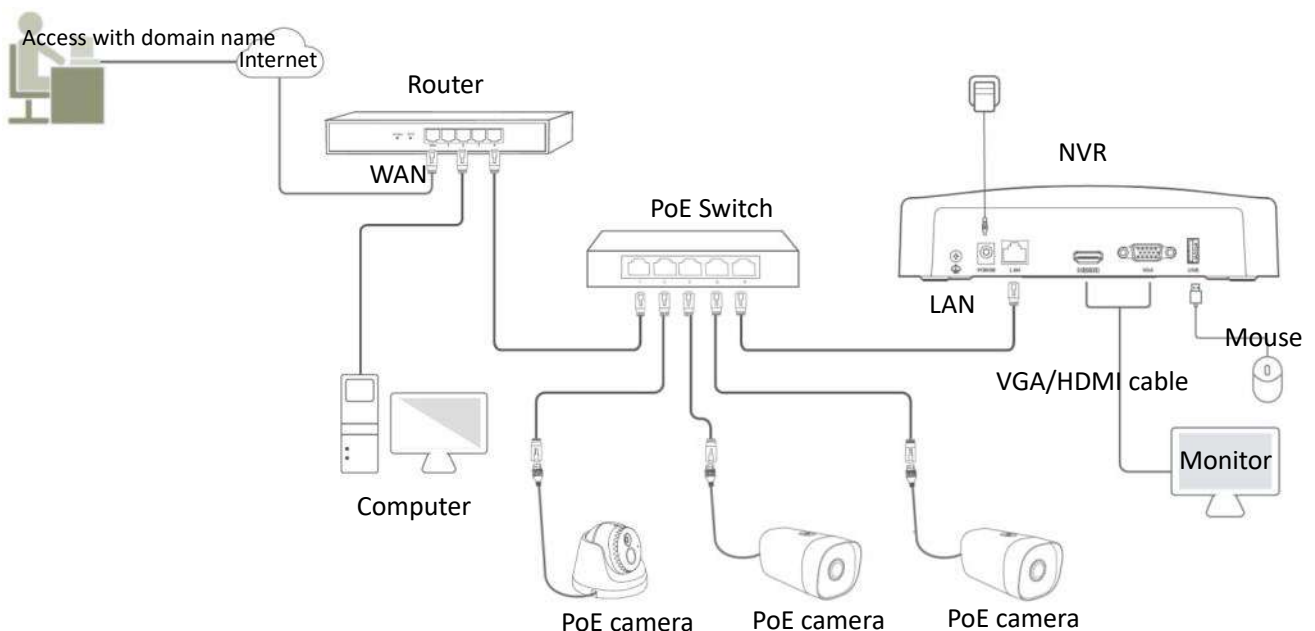



Please ensure that the WAN port of the router obtains a public IP address before configuring.

Procedures:

Step 1 [Log in to the GUI of the NVR.](#)

Step 2 Configure the DDNS.

1. Navigate to **Configuration > Network > DDNS**.
2. Set the button to the enabled status  .
3. Click the drop-down list to select **ISP**, which is **Dyndns DDNS** in this example.
4. Enter the applied domain name on the website of the **ISP**, which is **jointnet.dyndns.org** in this example.
5. Enter the login user name and login password registered on the website of the DDNS ISP, which are **Tom-Jerry** and **tomjerry123456** in this example.
6. Click **Save** at the bottom of the page.

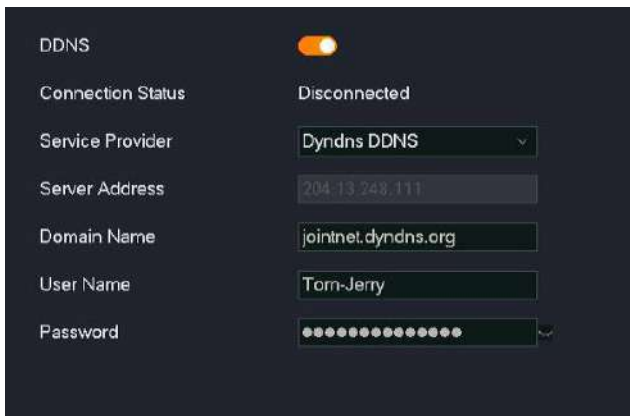

DDNS

Connection Status Disconnected

Service Provider Dyndns DDNS

Server Address 204.13.248.111

Domain Name jointnet.dyndns.org

User Name Tom-Jerry

Password ●●●●●●●●●●

Wait a moment, when the connection status is **Connected**, it is configured successfully.

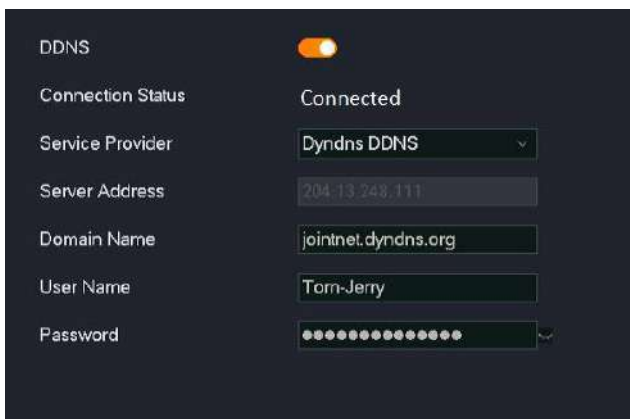

DDNS

Connection Status Connected

Service Provider Dyndns DDNS

Server Address 204.13.248.111

Domain Name jointnet.dyndns.org

User Name Tom-Jerry

Password ●●●●●●●●●●

Step 3 To configure the UPnP, please refer to the [Internet User Using the IP Address to Access the Web UI of the NVR](#) for detailed steps.

---End

After the setting completes, the user can use the domain name to successfully access the web UI of the NVR. When configuring the UPnP, the external port of the HTTPS is not the default port number, the access format is https://domain name: external port.

The access address is https://jointnet.dyndns.org in this example.

UPnP

Overview

Navigate to **Configuration > Network > UPnP**.

The internet user cannot access the NVR by default. The UPnP function enables the internet user to access the NVR through an external IP address.

After the UPnP function is enabled, the NVR will open the internal network port and external network port of the designated service, and identify the corresponding service with the LAN IP address and the internal network port. If the NVR receives a request from the external network port of the internet, the NVR forwards the request to the corresponding internal network port, so that internet users can access the NVR through the external IP address.



The UPnP function of the NVR can be used with the UPnP function of the camera.

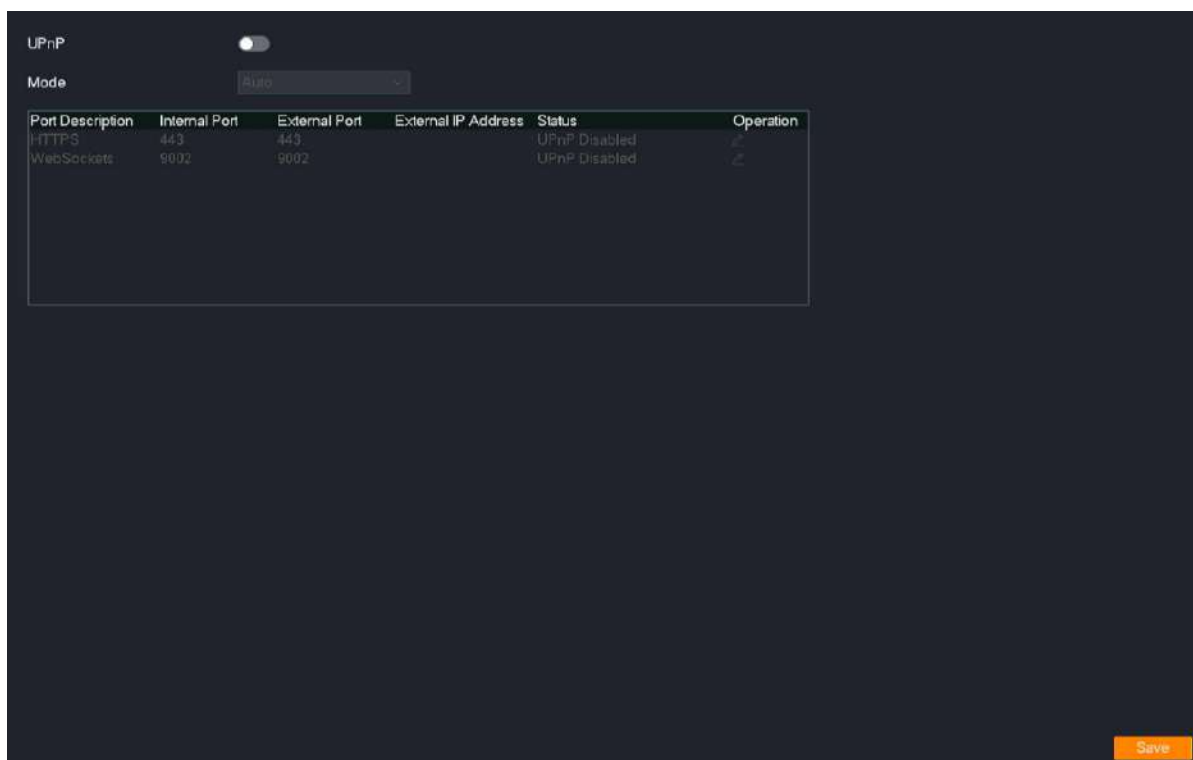

Parameter description

Parameter	Description
UPnP	It specifies whether to enable the UPnP function.
Mode	<p>It specifies the mode of port mapping.</p> <ul style="list-style-type: none"> – Auto: The system uses the preset external network port to map to the internal network port. – Custom: The system uses the custom external network port to map to the internal network port.
Port Description	It specifies the type of the port.
Internal Port	<p>It specifies the port of the corresponding service of the NVR.</p> <p>You can modify the port number on the Port Configuration page.</p>
External Port	<p>It specifies the port allows to internet users to access.</p> <p>The system presets the external port number. When the port mapping mode is Custom, you can customize the external port number.</p>

Parameter	Description
External IP Address	<p>It specifies the WAN IP address of the upstream router of the NVR.</p> <p> NOTE After the port mapping succeeded, the system will automatically fill in without any configuration.</p>
Status	<p>It specifies the status of each port mapping.</p> <ul style="list-style-type: none"> – Mapping Succeeded: The internal port is mapped to the external port successfully. – Router UPnP Disabled: The upstream router of the NVR does not enable the UPnP function. – UPnP Disabled: The UPnP function is disabled. – Mapping Failed: The internal port is not mapped to the external port successfully. You are recommended to customize the external port as the non-known port (1024 - 65535) and check whether the UPnP configuration is correct of the upstream router of the NVR.
Operation	<p>Available in the port mapping mode is Custom.</p> <p>You can customize the external port of the corresponding service.</p>

Internet User Using the IP Address to Access Web UI of the NVR

Scenario: Assume that you have set up a monitoring network with an NVR and connected to the internet.

Requirement: The user accesses the web UI of the NVR.

Solution: Configure the UPnP function to meet this requirement.

Assume that the WAN IP address of the upstream device is 102.33.66.88:

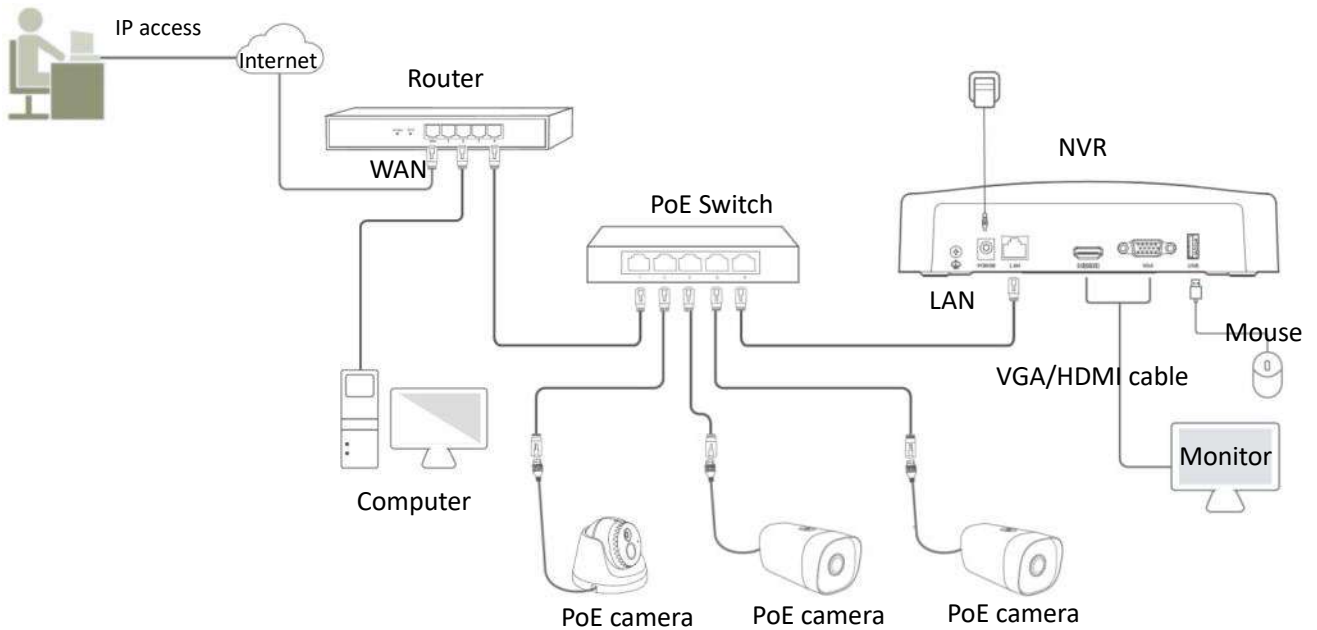

Please ensure that the WAN port of the router obtains a public IP address before configuring.

Procedures:**Step 1** [Log in to the GUI of the NVR.](#)**Step 2** Enable the UPnP function of the NVR.

1. Navigate to **Configuration > Network > UPnP**.
2. Set the button to the enabled status  .
3. Click **Save** .

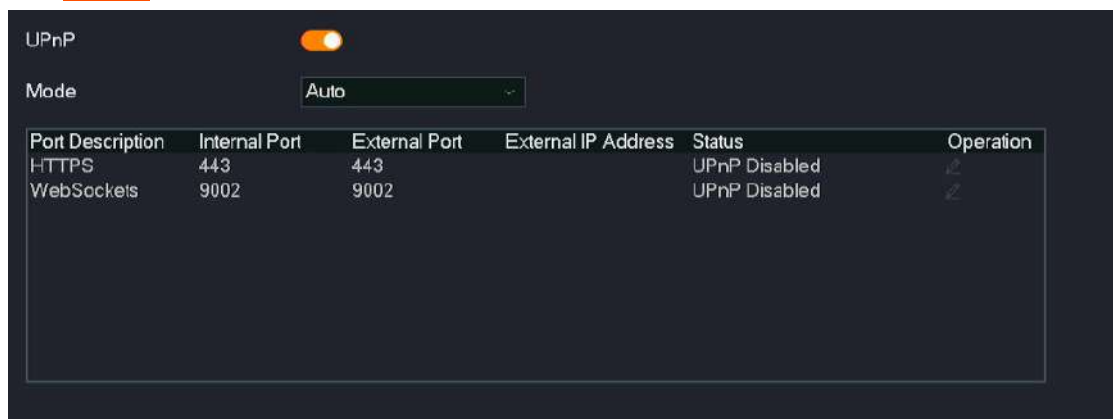

If the port mapping of the HTTPS service fails, try the following solutions:

- Set the mode to **Custom** and customize the external port of HTTPS as the non-known port (1024-65535). Note: When the external port is modified, the internal port will also be modified synchronously. At this time, when the LAN user uses the IP address of the NVR to access the web UI, the internal port needs to be added. The format is https://IP address of the NVR: internal port.
- Check whether the UPnP configuration of the upstream router of the NVR is correct.

Step 3 Enable the UPnP function of the router that is in the network.

Please refer to the user guide of the corresponding model for detailed steps.

---End

The internet user uses https://current IP address of WAN port of the router to successfully access the web UI of the NVR. If the external port of the HTTPS is not the default port number, the access format is https://current IP address of WAN port of the router: external port.

The access address is https://102.33.66.88 in this example.

4.6.6 System Configuration

On the system configuration page, you can configure the basic information of the NVR, set the system time, manage the login users and configure the live view parameters.

Basic Configuration

Overview

Navigate to **Configuration > System > Basics**.

You can configure the basic parameters of the NVR here, such as device name, language, output resolution, lock screen password.

The screenshot shows the 'System Configuration' page for an NVR. It features a dark background with white text. The settings are as follows:

- Device Name:** Tenda NVR
- Language:** English
- Output Resolution:** 1920*1080/60Hz
- Lock Screen Password:** Enabled (indicated by an orange toggle switch)

A 'Save' button is located in the bottom right corner of the configuration area.

Parameter description

Parameter	Description
Device Name	It specifies the name of the NVR. You can modify it as required.
Language	It specifies the language displayed on the GUI. You can modify it as required.
Output Resolution	It specifies the output resolution of the NVR. The resolution of different monitors is different. You can modify it according to the actual situation.

Parameter	Description
Lock Screen Password	<p>It specifies whether to enable the Lock Screen Password function.</p> <ul style="list-style-type: none"> – Enable: The default status. After you enter the GUI of the NVR, if there is no operation within the Lock Screen Time (default: 5 minutes, you can modify it as required), the system will automatically log out and return to the Live View page. If you want to enter the GUI, you need to log in again. – Disable: It is not restricted by “Need to log in again when the page is idle for a timeout” unless you log out or reboot the NVR. <p> TIP</p> <p>Only administrator account admin is supported.</p>

Disable Lock Screen Password

If you do not want to log in again when you enter the GUI even if there is no operation during the **Lock Screen Time**. You can disable the **Lock Screen Password**.

Procedures:

- Step 1** [Log in to the GUI of the NVR.](#)
- Step 2** Navigate to **Configuration > System > Basics**.
- Step 3** Disable the **Lock Screen Password** function.
- Step 4** Click **Save** at the bottom of the page.

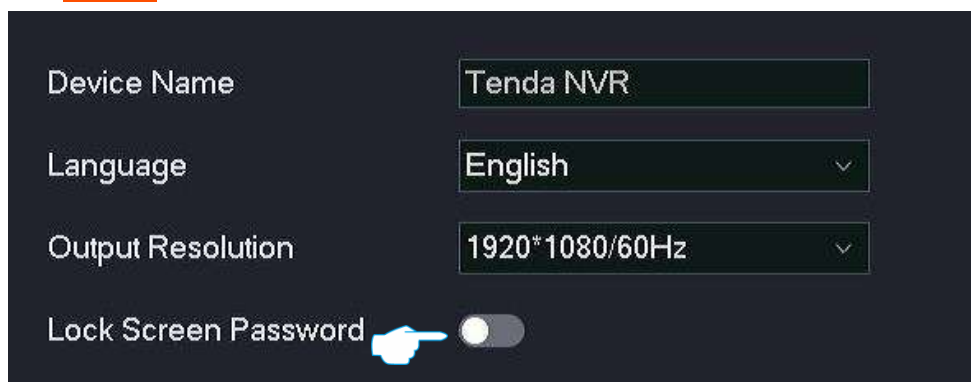

---End

After the setting completes, even if there is no operation during the **Lock Screen Time**, you can enter the GUI without logging in again.

Time Settings

Overview

Navigate to **Configuration > System > Time**.

You can set the system time of the NVR here.

To ensure that the time-based functions of the NVR take effect normally, it is necessary to ensure that the system time of the NVR is accurate. The NVR supports two time-setting methods: [Synchronize with the internet](#) and [Manual](#). The default is synchronizing with the internet.

The screenshot displays the 'Time Settings' configuration interface. Key parameters include:

- System Time:** 2022-01-07 14:27:38
- Time Zone:** (UTC+08:00) Beijing, Chon
- Date Format:** YYYY-MM-DD
- Time Synchronization:** Radio buttons for Manual and Internet (selected).
- NTP Server Address:** time.windows.com
- NTP Service Port:** 123
- Interval:** 10 minute(s) (Range: 1 to 10080)
- DST:** Toggle switch is turned on.
- Type:** Radio buttons for Date (selected) and Week.
- Start Time:** January 1 00:00
- End Time:** January 1 00:00
- DST Bias:** 60 minute(s)

A 'Save' button is located in the bottom right corner of the configuration area.

Parameter description

Parameter	Description
System Time	It specifies the current system time of the NVR.
Time Zone	It specifies the standard time zone in which the NVR locates.
Date Format	It specifies the format of the NVR system time.
Time Synchronization	They specify the synchronization mode of the NVR system time. <ul style="list-style-type: none"> – Manual: Set the date and time manually. – Internet: Synchronize the time of the NTP server according to the interval.

Parameter	Description
Date Time	Displayed when Time Synchronization is set to Manual . They are used to manually set the date and time of the NVR.
NTP Server Address	Displayed when Time Synchronization is set to Synchronize with the internet . It specifies the address or port of the time server.
NTP Service Port	Network Time Protocol (NTP) is used to synchronize the time between the client and the network time server. After the Internet function is enabled, the NVR will synchronize the system time through this NTP server according to the Interval .
Interval	Displayed when Time Synchronization is set to Synchronize with the internet . It specifies the time interval of the NVR to synchronize the system time to the NTP server.
DST	It specifies whether to enable the DST function. DST is a time system to save energy. The unified time adopted during the implementation of this system is called DST . If the country or region where the NVR is located implements the DST system, please enable the DST function.
Type	It specifies the type of the DST. Please select according to the local DST system.
Start Time End Time	They specify the start time and end time of the DST.
DST Bias	It specifies the time bias during the DST period. For example, the DST system implemented in a country or region is to move the time forward by one hour, the DST Bias should be set to 60 minutes.

Manually Synchronize the System Time

Manually setting the system time of the NVR, and it is used to the NVR that is disconnected from the internet.

Method 1

This method is applicable when the professional settings are hidden. When using this method to set the system time, if the NVR is connected to the internet, the system time will automatically synchronize with the NTP server according to the **Interval**.

- Step 1** [Log in to the GUI of the NVR.](#)
- Step 2** Navigate to **Configuration > System > Time**.
- Step 3** (Optional) Select the system time display format.
- Step 4** Set date and time.
- Step 5** Click **Save** at the bottom of the page.

Time Zone	(UTC+08:00) Beijing, Chon
Date Format	YYYY-MM-DD
Time Synchronization	<input checked="" type="radio"/> Manual <input type="radio"/> Internet
Date	2021 - 10 - 30
Time	17 : 32 : 07

---End

After the setting is completed, you can click **Show Pro Settings** in the lower-right corner to check whether the **System Time** on the page is accurate.

Method 2

This method is applicable when the professional settings are displayed.

- Step 1** [Log in to the GUI of the NVR.](#)
- Step 2** Navigate to **Configuration > System > Time.**
- Step 3** (Optional) Select the system time display format.
- Step 4** Set **Time Synchronization**, which is **Manual** in this example.
- Step 5** Set date and time.
- Step 6** Click **Save** at the bottom of the page.

System Time	2021-10-30 17:32:07
Time Zone	(UTC+08:00) Beijing, China
Date Format	YYYY-MM-DD
Time Synchronization	<input checked="" type="radio"/> Manual <input type="radio"/> Internet
Date	2021 - 10 - 30
Time	17 : 32 : 07

---End

After the setting completes, you can check whether the **System Time** on the page is accurate.

Synchronize the System Time Through Internet

This method is applicable when the professional settings are displayed.

After the NVR is successfully connected to the internet, without settings again, the system time will automatically synchronize with the NTP server according to the **Interval**. You can modify the NTP server and time synchronization according to the actual situation.

Refer to [Internet Settings](#) for the camera accesses to the internet method.

Procedures:

- Step 1** [Log in to the GUI of the NVR.](#)
- Step 2** Navigate to **Configuration > System > Time**.
- Step 3** Select the time zone in which the NVR locates.
- Step 4** (Optional) Select the system time display format.
- Step 5** Set **Time Synchronization**, which is **Internet** in this example.
- Step 6** Click **Save** at the bottom of the page.

System Time	2021-10-30 17:30:13	
Time Zone	(UTC+08:00) Beijing, Chon	
Date Format	YYYY-MM-DD	
Time Synchronization	<input type="radio"/> Manual <input checked="" type="radio"/> Internet	
NTP Server Address	time.windows.com	
NTP Service Port	123	
Interval	10	minute(s) (Range: 1 to 10080)

---End

After the setting completes, you can check whether the **System Time** on the page is accurate.

Enable DST

If the country or region where the NVR is located implements the DST system, please enable the DST function.

Procedures:

- Step 1** [Log in to the GUI of the NVR.](#)
- Step 2** Navigate to **Configuration > System > Time.**
- Step 3** Find DST, then set the button to the enabled status  .
- Step 4** Select the type of DST.
- Step 5** Select the start time and end time of DST.
- Step 6** Set the time bias during the DST period.
- Step 7** Click **Save** at the bottom of the page.

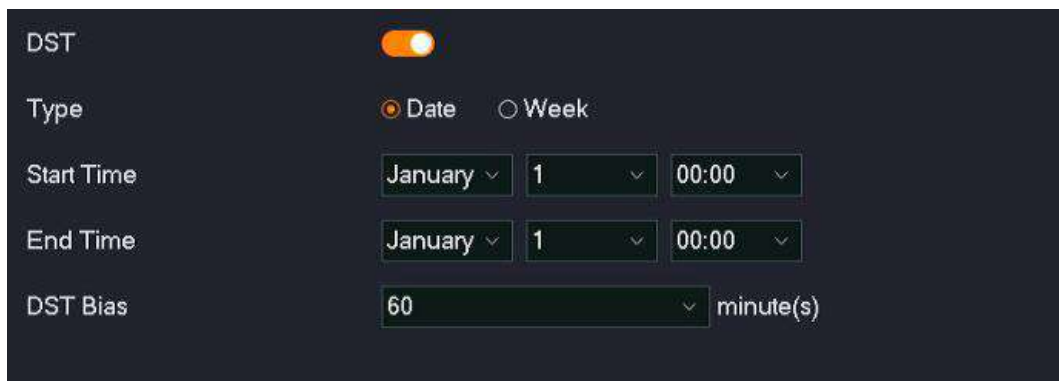

The screenshot shows the DST configuration interface. It includes a toggle switch for DST, which is currently turned on. Below the toggle, there are radio buttons for 'Date' (selected) and 'Week'. The 'Start Time' and 'End Time' are both set to 'January 1 00:00'. The 'DST Bias' is set to '60 minute(s)'.

---End

After the setting completes, the system time will perform the DST system of this time zone in this period you set. You can check whether the **System Time** on the current page is correct.

User Management

Overview



Navigate to **Configuration > System > Users**.

You can modify and add the login account information of the NVR here to prevent unauthorized users from entering the GUI of the NVR to change the settings.

No.	User Name	User Type	Operation
1	admin	Administrator	

Parameter description

Parameter	Description
No.	It specifies the number of the login account.
User Name	It specifies the user name allowed to log in to the GUI.
User Type	<p>It specifies the login user type.</p> <ul style="list-style-type: none"> – Administrator: After you log in to the NVR with this type of account, you can add a login account and view or modify all configurations of the NVR. – Common user: After you log in to the NVR with this type of account, you have local authority and channel authority. The allowed authority items are subject to the assignment of the administrator.

Parameter	Description
Operation	<p>It is used to perform for the login account.</p> <ul style="list-style-type: none"> Click  to modify such information as the user name, password and permissions of the account. The administrator account and the common user support different edit items. The actual page prevails. Click  to delete the account. The administrator account cannot be deleted.

The NVR allows administrator user to add common users and assign permissions to common users. Click **Add** in the lower-right corner to add a login account.

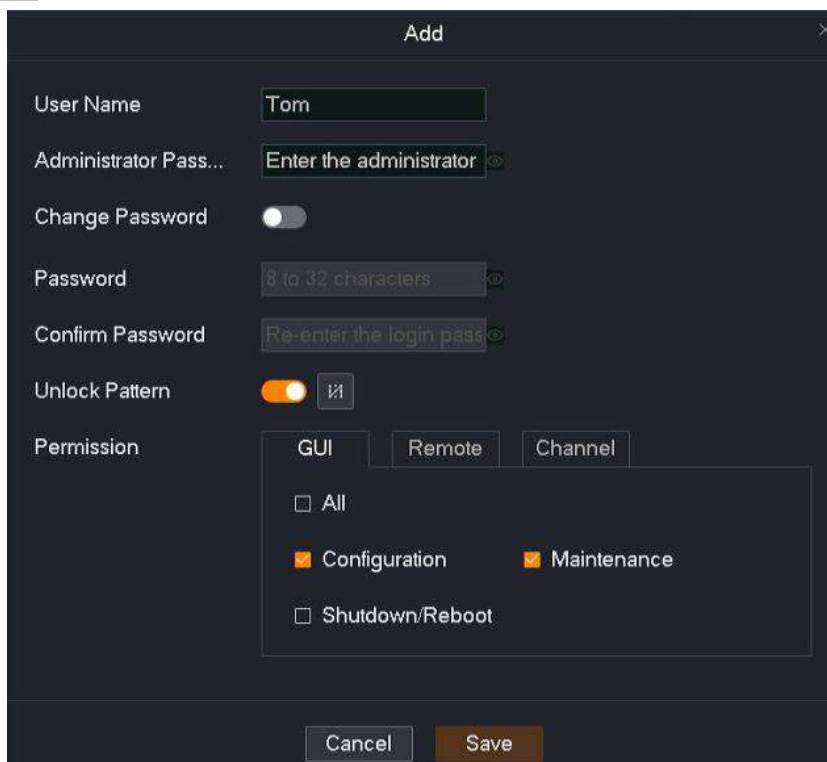

Parameter description

Parameter	Description
User Name	
Password	They specify the login user name, password and confirm the password to enter the GUI.
Confirm Password	

Parameter	Description
Unlock Pattern	<p>It specifies whether to use a pattern to log in to the GUI.</p> <p>After it is enabled, you need to draw an unlock pattern by following the instructions.</p>
Permission	<p>It specifies the permission of the account.</p> <ul style="list-style-type: none"> – GUI: It specifies the local operation permission, which includes configuration, maintenance, and shutdown or reboot. – Remote: It specifies the remote management permission. Configuration and system management are supported for now. – Channel: It specifies the channels that can be operated and channel permissions (live view and playback are supported for now).

Add User

Assume that the administrator wants to add a login account for Tom.

The account can be used to:

- Log in to the GUI using a password and pattern.
- Configure and maintain with local permissions.
- Configure operation with remote permissions.
- Preview and play back recordings of channels D1 to D3 with channel permissions.

Procedures:

Step 1 [Log in to the GUI of the NVR.](#)

Step 2 Navigate to **Configuration > System > Users.**

Step 3 Add the login user account.

1. Click **Add** in the lower-right corner.
2. Set the user name and password. The following figure is for reference only.
3. Re-enter the login password in **Confirm Password** input box.
4. Enable the **Unlock Pattern** and draw an unlock pattern by following the instruction.

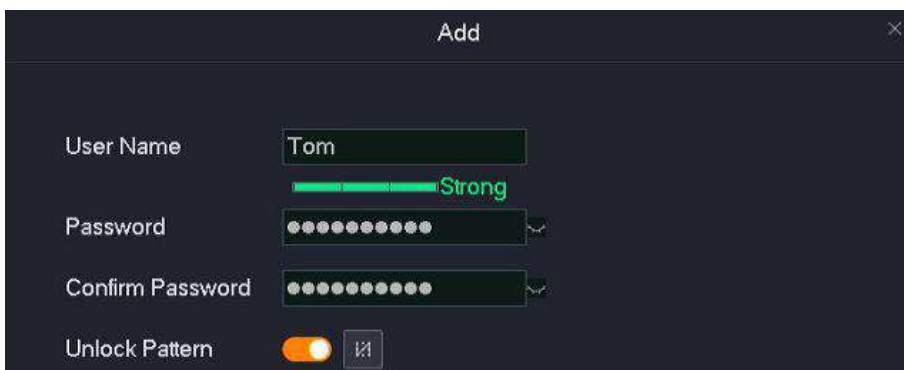

5. Set the management permissions of this account.
 - (1) Set the local permission of this account, which are **Configuration** and **Maintenance** in this example.



- (2) Click **Remote** and set the remote permission of this account, which is **Configuration** in this example.

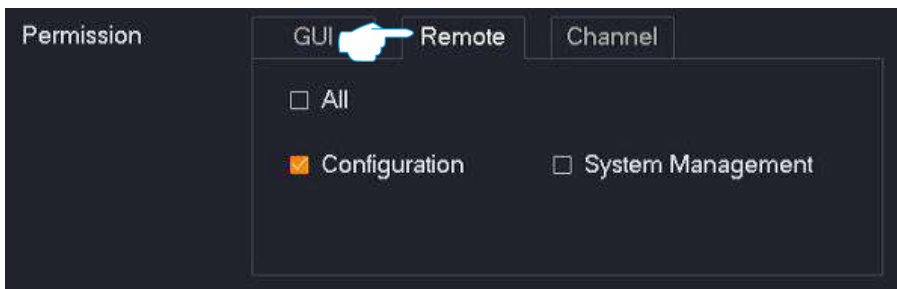

- (3) Click **Channel** and set related-permissions, which is **Live view** and **Playback** permission of the D1 to D3 in this example.

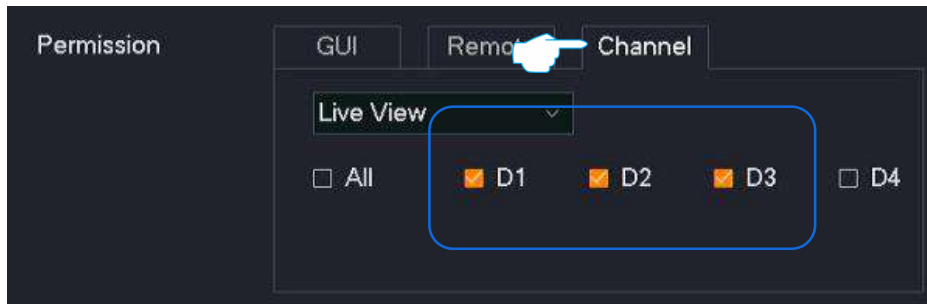

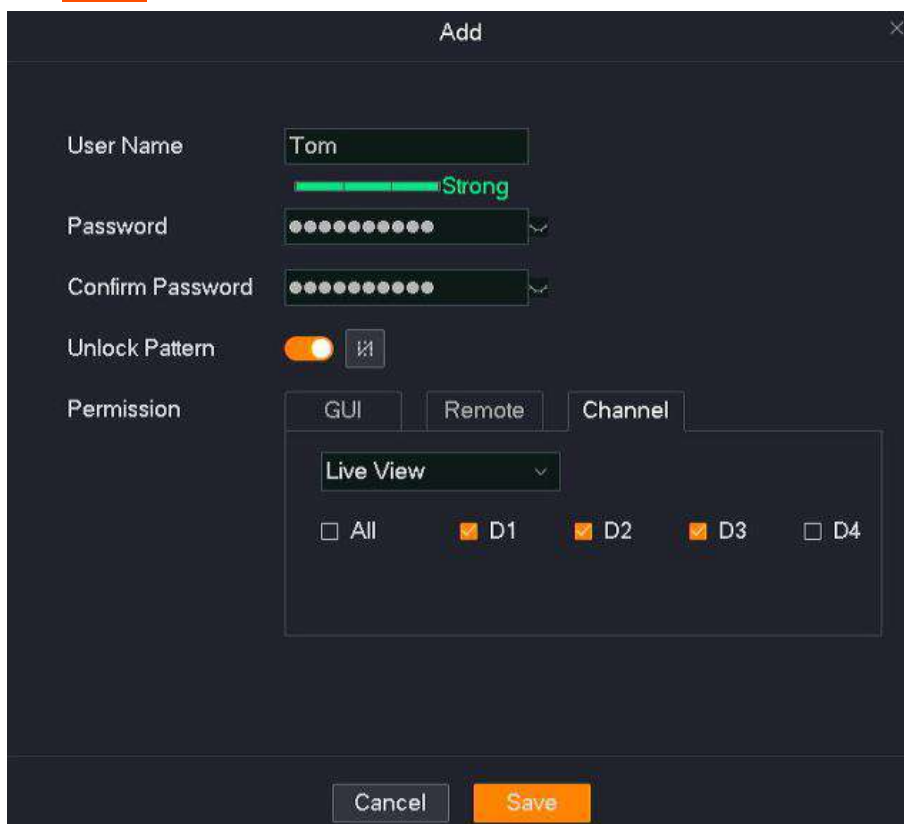

Step 4 Click **Save**.



---End

After the setting completes, when logging in with the user name **Tom**, both password and pattern login are supported. During local management, configuration and maintenance can be performed, and the recordings of D1 to D3 can be play backed and live viewed. During remote access, the configuration can be operated.



No.	User Name	User Type	Operation
1	admin	Administrator	
2	Tom	Common user	 

Modify User Info

Assume that you want to modify the login unlock pattern of **Tom**.

Procedures:

- Step 1** Log in to the GUI of the NVR.
- Step 2** Navigate to **Configuration > System > Users**.
- Step 3** Find the user name of the user for which the login and unlock pattern is to be modified, and click .

No.	User Name	User Type	Operation
1	admin	Administrator	
2	Tom	Common user	 

Step 4 Enter the administrator password.

Step 5 Click the unlock pattern icon , then follow the on-screen instructions to draw an unlock pattern.

Step 6 Click **Save**.

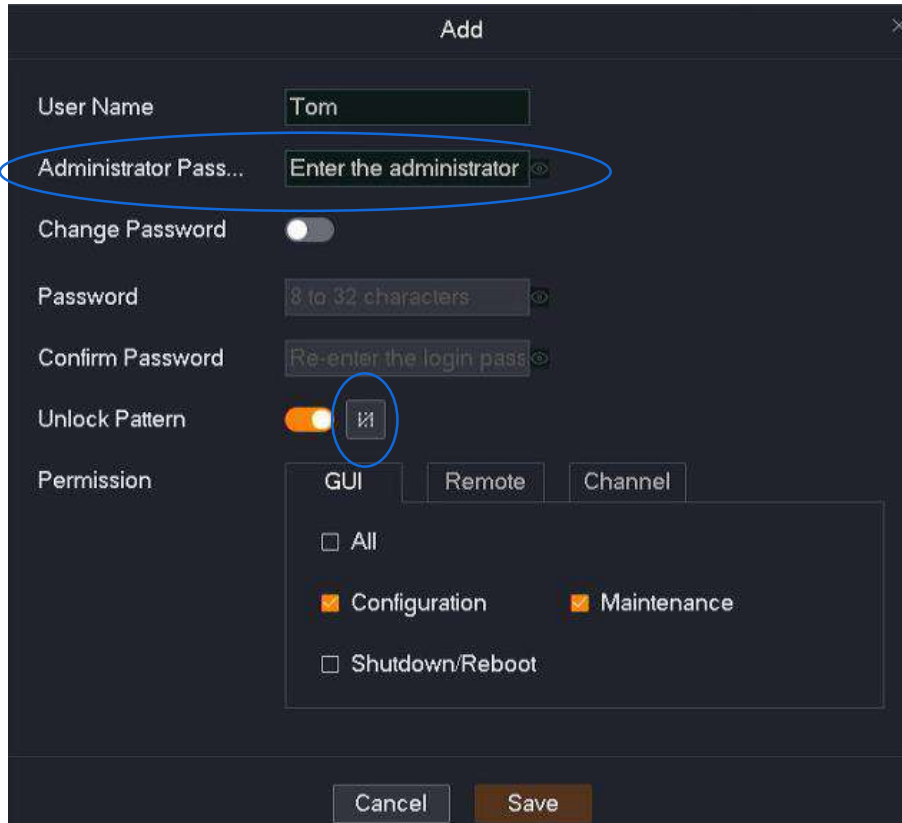

The screenshot shows a dark-themed 'Add' dialog box with the following fields and options:

- User Name: Tom
- Administrator Pass...: Enter the administrator (circled in blue)
- Change Password: Off
- Password: 8 to 32 characters
- Confirm Password: Re-enter the login pass
- Unlock Pattern: On (toggle and icon circled in blue)
- Permission: GUI (selected), Remote, Channel
 - All
 - Configuration
 - Maintenance
 - Shutdown/Reboot

Buttons: Cancel, Save

---End

Live View Configuration

Overview

Navigate to **Configuration > System > Live View**.

You can modify the live view information of the NVR, including auto-switch dwell time, single-screen alarm dwells time, lock screen time and default live view division.

Auto-switch Dwell Time	5	second(s)
Single Screen Alarm Dwell Time	5	second(s)
Lock Screen Time	5	minute(s)
Default Live View Division	4	screen(s)

Parameter description

Parameter	Description
Auto-switch Dwell Time	It specifies the image dwell time during auto-switch live view on the Live View page.
Single Screen Alarm Dwell Time	It specifies the dwell time of the single-screen display of the alarm image when the alarm mode is Single-screen display and an alarm is triggered.
Lock Screen Time	It specifies the page idle timeout time. After entering the GUI of the NVR, if there is no operation during the Lock Screen Time , the system will automatically log out and return to the Live View page.

Parameter	Description
Default Live View Division	It specifies the default number of division screens for a single screen of the live view page. You can modify it according to the actual situation.

Set Lock Screen Time

Assume that you want to extend the page timeout time.

Procedures:

- Step 1** [Log in to the GUI of the NVR.](#)
- Step 2** Navigate to **Configuration > System > Live View.**
- Step 3** Click the drop-down list of the **Lock Screen Time**, then select the corresponding time, which is **30 minutes** in this example.
- Step 4** Click **Save** at the bottom of the page.



---End

After the setting completes, when you enter the GUI of the NVR, if there is no operation within 30 minutes, the system will automatically log out and return to the **Live View** page. If you want to enter the GUI, you need to log in again.

4.7 Maintenance

On the maintenance page, you can check the device information and channel information of the NVR, and can also perform maintenance operations on the NVR, including device upgrade, device log view or export, network detection and device maintenance.

4.7.1 Devie Info

Navigate to **Maintenance > Device Info**.

You can view such basic information as device name, device model, software version, software release time and system time of the NVR.

Device Name	Tenda NVR
Device Model	N3L-4H
Device S/N	2106C5110100000025
Firmware Version	V12.1.3.9
Release Date	2021-12-22
System Time	2022-01-06 17:55:54
Uptime	0day(s)00hour(s)38minute(s)

Parameter description

Parameter	Description
Device Name	It specifies the name of the NVR.
Device Model	It specifies the model of the NVR.
Device S/N	It specifies the S/N of the NVR.
Firmware Version	It specifies the version number of the current system firmware of the NVR.
Release Date	It specifies the release time of the current system firmware of the NVR.
System Time	It specifies the current system time of the NVR.
Uptime	It specifies the time during which the NVR is operating since the last start.

4.7.2 Channel Info

Navigate to **Maintenance > Channel Info**.

You can view such channel information as channel name, camera model, IP address, status and resolution of the NVR.

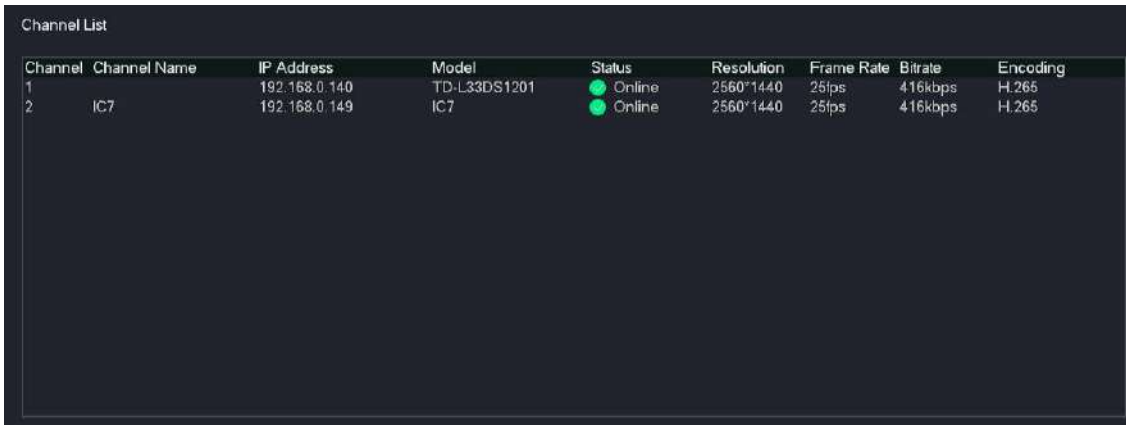

Channel	Channel Name	IP Address	Model	Status	Resolution	Frame Rate	Bitrate	Encoding
1		192.168.0.140	TD-L33DS1201	Online	2560*1440	25fps	416kbps	H.265
2	IC7	192.168.0.149	IC7	Online	2560*1440	25fps	416kbps	H.265

Parameter description

Parameter	Description
Channel	It specifies the number of channels in which the camera locates.
Channel Name	It specifies the name of channels in which the camera locates.
IP Address	It specifies the IP address of the camera.
Model	It specifies the model of the camera.

Parameter	Description
Status	<p>It specifies the status of the camera.</p> <ul style="list-style-type: none"> – Connecting... (Logging in...): The NVR is trying to log in to the camera. – Online: The NVR has successfully added a camera, and you can view or manage the camera through the NVR GUI. – Exception: The NVR failed to add a camera. The detailed reasons for the exception are as follows: <ul style="list-style-type: none"> • Disconnected: The camera is not connected to the NVR. • Incorrect user name or password: The user name or password of the camera is incorrect. • The user has been locked: The login user of the camera has been locked. • Network error: The network between the camera and the NVR is disconnected. Please ensure that the network connection between the camera and the NVR is normal, and the network parameters are configured correctly.
Resolution	It specifies the resolution of the camera video. The higher the resolution, the clearer the image and the more obvious details.
Frame Rate	It specifies the frame rate of the camera video. The higher the frame rate, the smoother the image.
Bitrate	It specifies the data traffic used by the camera video file per unit time. The larger the bit rate, the better the picture quality.
Encoding	It specifies the encoding standard of the camera video.

4.7.3 Device Upgrade

Navigate to **Maintenance > Device Upgrade**.

The firmware upgrade enables the NVR to get new or more stable performance. The NVR only supports **Local Upgrade** for now.



- To avoid damage to the NVR, please use the correct upgrade file to upgrade. Generally, the suffix of the firmware upgrade file is .bin.
- During upgrading, do not directly cut off the power supply of the NVR; it may cause upgrade fails or damage the NVR.

Method 1

It is applicable for the NVR that cannot be connected to the mouse and the USB storage device at the same time.

Step 1 Visit www.tendacn.com to download the latest upgrade firmware of the corresponding camera model, and unzip it to the root directory of the USB device.

Step 2 Save the upgrade file to the root directory of the USB storage device.



The NVR can only recognize USB storage devices formatted as FAT32 for now.

Step 3 [Log in to the GUI of the NVR](#) to upgrade firmware.

1. Navigate to **Maintenance > Device Upgrade**, and click **Local Upgrade**.

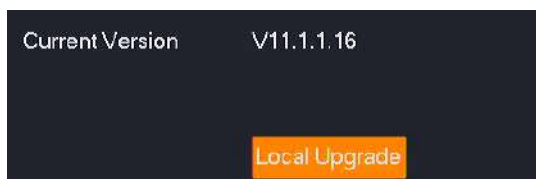

2. Unplug the mouse and connect the USB storage device to the USB port of the NVR within 1 minute.



The system will automatically verify and select the latest version upgrade file in the USB storage device that fits the current NVR model to upgrade.

---End

After the system detects the upgrade file, it will be upgraded automatically. Please wait with the patience.

After the upgrade completes, unplug the USB storage device, and re-plug in the mouse to enter the GUI of the NVR, and check the **Current version** of the NVR on the **Device upgrade** page to confirm that it is the same as the firmware version you just upgraded.

Method 2

It is applicable for the NVR that can be connected to the mouse and the USB storage device at the same time.



If the NVR has only one USB port or the USB port has been used, you need to prepare a USB hub by yourself.

- Step 1** Visit www.tendacn.com to download the latest upgrade firmware of the corresponding camera model, and unzip it to the root directory of the USB device.
- Step 2** Save the upgrade file to the root directory of the USB storage device.



The NVR can only recognize USB storage devices formatted as FAT32 for now.

- Step 3** [Log in to the GUI of the NVR](#) to upgrade firmware.
1. Navigate to **Maintenance > Device Upgrade**, and click **Local Upgrade**.

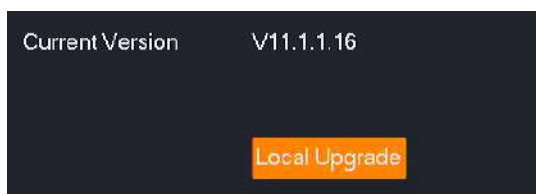

- Click the drop-down list to select your USB storage device, then select upgrade file (the suffix of the file is .bin.), and click **Upgrade**.

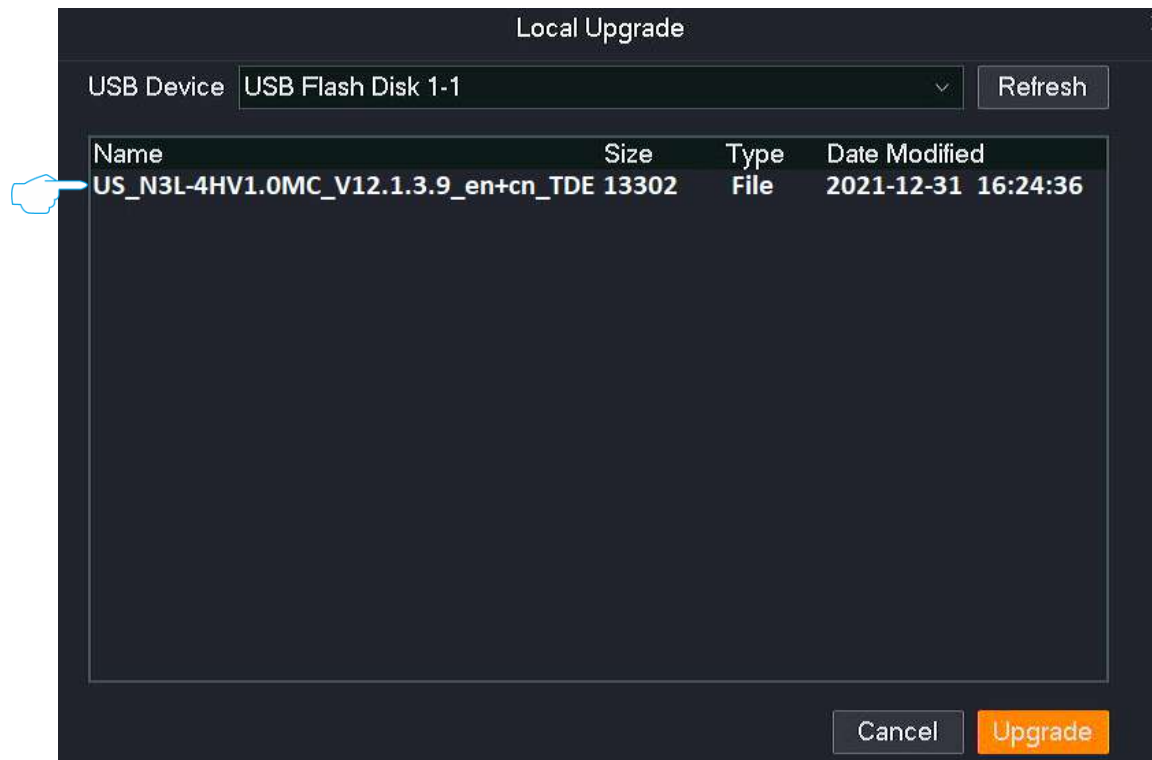

---End

Wait for a moment until the ongoing process finishes. Log in to the GUI of the NVR again. Check the **Current Version** of the NVR on the **Firmware Upgrade** page to confirm the firmware version of your NVR is the same as the latest firmware version.

4.7.4 System Log

Overview

Navigate to **Maintenance > Device Log**.

The system log records such information as running status, configuration information, alarm information, exception conditions of the system. You can use system logs for viewing alarm information and troubleshooting. It is recommended to check and back up logs regularly.

No.	Time	Type	Detail
1	2021-10-30 09:40:02	Operation	Shutdown{"Shutdown Time":"2000-00-00 00:00:00"}
2	2021-10-30 09:40:05	Operation	Start Up{"Disk":1,"Flag":"1"}
3	2021-10-30 09:40:05	Exception	IPC Disconnect{"Channel":"1"}
4	2021-10-30 09:40:05	Exception	IPC Disconnect{"Channel":"2"}
5	2021-10-30 09:40:05	Exception	IPC Disconnect{"Channel":"3"}
6	2021-10-30 09:40:05	Exception	IPC Disconnect{"Channel":"4"}
7	2021-10-30 09:40:06	Exception	Network Failure{"Network Failure":"eth0"}
8	2021-10-30 09:41:09	Operation	User Login{"Address":"","LoginAs":"Local","Session":"2"}
9	2021-10-30 09:56:49	Operation	User Login{"Address":"","LoginAs":"Local","Session":"4"}
10	2021-10-30 10:12:21	Operation	Modify Password{"Modify User":"admin","Session":"6"}
11	2021-10-30 10:12:21	Operation	User Login{"Address":"","LoginAs":"Local","Session":"7"}
12	2021-10-30 10:14:28	Operation	User Login{"Address":"","LoginAs":"Local","Session":"8"}
13	2021-10-30 10:15:07	Configuration	Modify Configuration{"Config Name":"VideoWidget","New Config":"","Old Config"}
14	2021-10-30 10:15:07	Operation	Shutdown{"Shutdown Time":"2000-00-00 00:00:00"}
15	2021-10-30 10:15:09	Operation	Start Up{"Disk":1,"Flag":"1"}
16	2021-10-30 10:15:11	Configuration	Modify Configuration{"Config Name":"LoginSet","New Config":"","Old Config"}
17	2021-10-30 10:15:11	Exception	Video Lost{"Channel":"1"}
18	2021-10-30 10:15:11	Exception	Video Lost{"Channel":"2"}
19	2021-10-30 10:15:11	Exception	Video Lost{"Channel":"3"}
20	2021-10-30 10:15:11	Exception	Video Lost{"Channel":"4"}
21	2021-10-30 10:15:11	Exception	Network Failure{"Network Failure":"eth0"}
22	2021-10-30 10:16:15	Operation	Modify Password{"Modify User":"admin","Session":"1"}
23	2021-10-30 10:16:16	Configuration	Modify Configuration{"Config Name":"LoginSet","New Config":"","Old Config"}
24	2021-10-30 10:16:16	Configuration	Modify Configuration{"Config Name":"NetCommon","New Config":"","Old Config"}
25	2021-10-30 10:16:16	Configuration	Modify Configuration{"Config Name":"NetCommon","New Config":"","Old Config"}

Total: 229 << 1 / 3 >> 1

Export Log

Check System Log

Assume that you want to check the exception log information from 12:00:00 on October 30, 2021, to 16:00:00 on October 31, 2021.

Procedures:

Step 1 [Log in to the GUI of the NVR.](#)

Step 2 Navigate to **Maintenance > Device Log.**

Step 3 Set **Type**, which is **Exception** in this example.

Step 4 Set the **Start Time** and **End Time**, which is **12:00:00 on October 30, 2021**, to **16:00:00 on October 31, 2021**, in this example.

Step 5 Click **Search**.

The screenshot shows a search interface with the following fields:

- Type: Exception (dropdown menu)
- Start Time: 2021 - 10 - 30 12 : 00 : 00
- End Time: 2021 - 10 - 31 16 : 00 : 00
- Search button

---End

After the search completes, you can check the related information as required.

The screenshot shows the search results table with the following columns: No., Time, Type, and Detail. The table contains 16 rows of data.

No.	Time	Type	Detail
1	2021-10-30 14:54:52	Exception	Network Failure{"Network Failure":"eth0"}
2	2021-10-30 16:22:13	Exception	IPC Disconnect{"Channel":"3"}
3	2021-10-30 16:22:14	Exception	Video Lost{"Channel":"3"}
4	2021-10-30 16:22:39	Exception	IPC Disconnect{"Channel":"4"}
5	2021-10-30 16:22:39	Exception	Video Lost{"Channel":"4"}
6	2021-10-30 16:22:57	Exception	IPC Disconnect{"Channel":"3"}
7	2021-10-30 16:22:57	Exception	Video Recover{"Channel":"3"}
8	2021-10-30 16:23:54	Exception	Video Recover{"Channel":"4"}
9	2021-10-30 16:23:54	Exception	Login IPC Fail{"Channel":"4","IPCAddr":"192.168.0.0","Result":"Login Error"}
10	2021-10-30 16:24:10	Exception	Video Lost{"Channel":"4"}
11	2021-10-30 16:24:20	Exception	Video Recover{"Channel":"4"}
12	2021-10-30 16:27:11	Exception	Video Lost{"Channel":"4"}
13	2021-10-30 16:28:01	Exception	Video Recover{"Channel":"4"}
14	2021-10-30 16:28:07	Exception	Login IPC Fail{"Channel":"4","IPCAddr":"192.168.8.201","Result":"Login Error"}
15	2021-10-30 16:28:22	Exception	Video Lost{"Channel":"4"}
16	2021-10-30 16:28:57	Exception	Video Recover{"Channel":"4"}

Total: 16

Export System Log

Assume that you want to check the exception log information from 12:00:00 on October 30, 2021 to 16:00:00 on October 31, 2021.



The NVR can only recognize USB storage devices formatted as FAT32 for now.

Method 1

It is applicable for the NVR cannot be connected to the mouse and the USB storage device at the same time.

Step 1 [Log in to the GUI of the NVR.](#)

Step 2 Navigate to **Maintenance > Device Log.**

Step 3 Set **Type**, which is **Exception** in this example.

Step 4 Set the **Start Time** and **End Time**, which is **12:00:00 on October 30, 2021**, to **16:00:00 on October 31, 2021**, in this example.

Step 5 Click **Search**.

Step 6 Click **Export Log** in the lower-right corner.

No.	Time	Type	Detail
1	2021-10-30 14:54:52	Exception	Network Failure{"Network Failure":"","eth0"}
2	2021-10-30 16:22:13	Exception	IPC Disconnect{"Channel":"","3"}
3	2021-10-30 16:22:14	Exception	Video Lost{"Channel":"","3"}
4	2021-10-30 16:22:39	Exception	IPC Disconnect{"Channel":"","4"}
5	2021-10-30 16:22:39	Exception	Video Lost{"Channel":"","4"}
6	2021-10-30 16:22:57	Exception	IPC Disconnect{"Channel":"","3"}
7	2021-10-30 16:22:57	Exception	Video Recover{"Channel":"","3"}
8	2021-10-30 16:23:54	Exception	Video Recover{"Channel":"","4"}
9	2021-10-30 16:23:54	Exception	Login IPC Fail{"Channel":"","4","IPAddr":"","192.168.0.0","Result":"","Login Error"}
10	2021-10-30 16:24:10	Exception	Video Lost{"Channel":"","4"}
11	2021-10-30 16:24:20	Exception	Video Recover{"Channel":"","4"}
12	2021-10-30 16:27:11	Exception	Video Lost{"Channel":"","4"}
13	2021-10-30 16:28:01	Exception	Video Recover{"Channel":"","4"}
14	2021-10-30 16:28:07	Exception	Login IPC Fail{"Channel":"","4","IPAddr":"","192.168.8.201","Result":"","Login Error"}
15	2021-10-30 16:28:22	Exception	Video Lost{"Channel":"","4"}
16	2021-10-30 16:28:57	Exception	Video Recover{"Channel":"","4"}

Total:16 << 1/1 >> 1

Step 7 Unplug the mouse and connect the USB storage device to the USB port of the NVR within 1 minute.

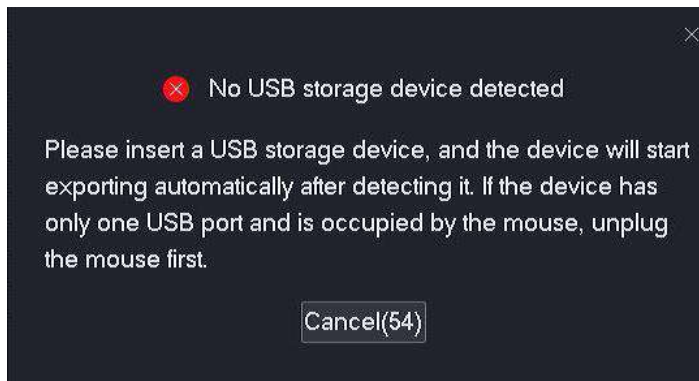

---End

The system log with the suffix of .txt will be exported to the root directory of the USB storage device.

Method 2

It is applicable for the NVR that can be connected to the mouse and the USB storage device at the same time.



If the NVR has only one USB port or the USB port has been used, you need to prepare a USB hub by yourself.

Step 1 Connect the USB storage device to the USB port of the NVR.

Step 2 [Log in to the GUI of the NVR](#), and export the system log.

1. Navigate to **Maintenance > Device Log**.
2. Set **Type**, which is **Exception** in this example.
3. Set the **Start Time** and **End Time**, which is **12:00:00 on October 30, 2021** to **16:00:00 on October 31, 2021**, in this example.
4. Click **Search**, and click **Export Log** in the lower-right corner.

No.	Time	Type	Detail
1	2021-10-30 14:54:52	Exception	Network Failure{"Network Failure":"eth0"}
2	2021-10-30 16:22:13	Exception	IPC Disconnect{"Channel":"3"}
3	2021-10-30 16:22:14	Exception	Video Lost{"Channel":"3"}
4	2021-10-30 16:22:39	Exception	IPC Disconnect{"Channel":"4"}
5	2021-10-30 16:22:39	Exception	Video Lost{"Channel":"4"}
6	2021-10-30 16:22:57	Exception	IPC Disconnect{"Channel":"3"}
7	2021-10-30 16:22:57	Exception	Video Recover{"Channel":"3"}
8	2021-10-30 16:23:54	Exception	Video Recover{"Channel":"4"}
9	2021-10-30 16:23:54	Exception	Login IPC Fail{"Channel":4,"IPAddr":"192.168.0.0","Result":"Login Error"}
10	2021-10-30 16:24:10	Exception	Video Lost{"Channel":"4"}
11	2021-10-30 16:24:20	Exception	Video Recover{"Channel":"4"}
12	2021-10-30 16:27:11	Exception	Video Lost{"Channel":"4"}
13	2021-10-30 16:28:01	Exception	Video Recover{"Channel":"4"}
14	2021-10-30 16:28:07	Exception	Login IPC Fail{"Channel":4,"IPAddr":"192.168.8.201","Result":"Login Error"}
15	2021-10-30 16:28:22	Exception	Video Lost{"Channel":"4"}
16	2021-10-30 16:28:57	Exception	Video Recover{"Channel":"4"}

5. Click the drop-down list to select your USB storage device, and click **Export**.

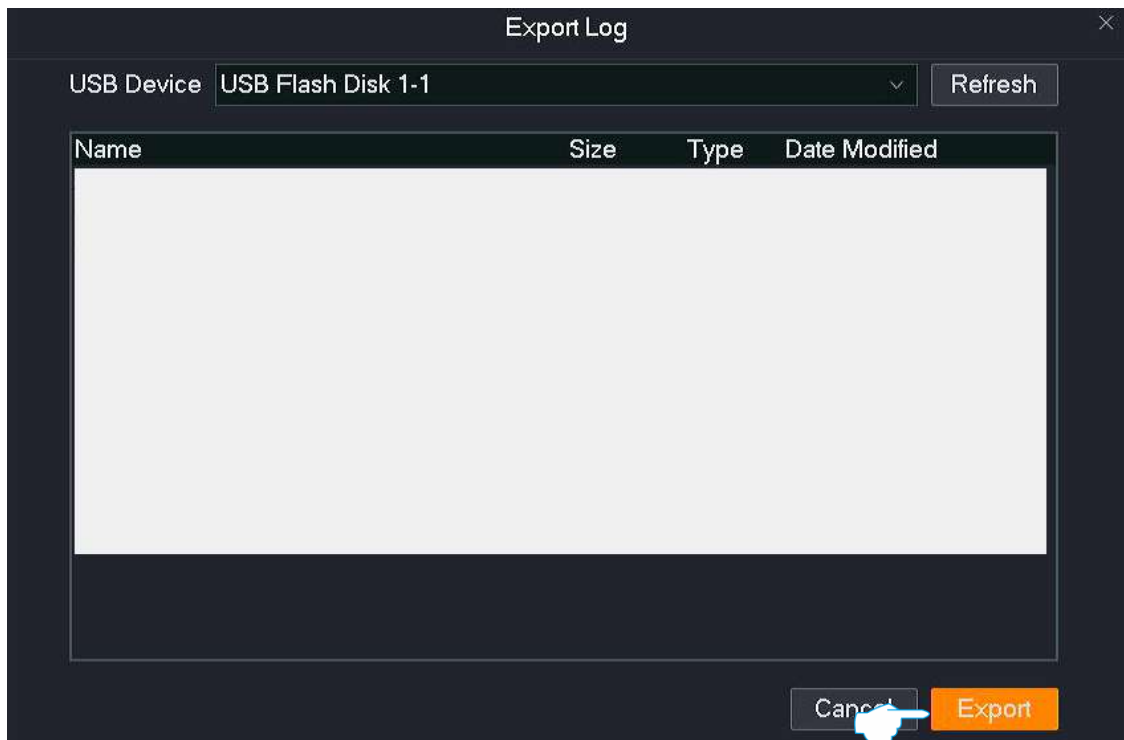

---End

The system log with the suffix of .txt will be exported to the root directory of the USB storage device.

4.7.5 Diagnosis

Overview

Navigate to **Maintenance > Diagnosis**.

You can check the bandwidth usage of the NVR and perform network detection here.

The screenshot displays the 'Diagnosis' interface with the following elements:

- Input Bandwidth:** A progress bar showing 1.6Mbps used (orange) and 58.4Mbps available (grey).
- Output Bandwidth:** A progress bar showing 0.2Mbps used (orange) and 59.8Mbps available (grey).
- One-key Diagnosis:** A prominent orange button labeled 'One-key Diagnosis'.
- Custom Diagnosis:** Radio buttons for 'Ping' (selected) and 'Traceroute'.
- Target Address:** A text input field containing 'IP address/Domain name'.
- Packet Size:** A text input field containing '64'.
- Packet Number:** A text input field containing '4'.
- Start:** A button to initiate the diagnosis.

Parameter description

Parameter	Description
Input Bandwidth	It specifies the usage of the NVR input bandwidth (used for receiving data from cameras). Cameras cannot be added when the bandwidth is used up.
Output Bandwidth	It specifies the usage of the NVR output bandwidth (used for forwarding data from cameras). Remote live view, playback and download cannot be conducted when the bandwidth is used up.
One-key Diagnosis	It is used to diagnose the network connectivity and network quality of all channels.

Parameter	Description
Custom Diagnosis	<p>It specifies the network diagnosis method.</p> <ul style="list-style-type: none"> – Ping: Used to check whether the connection is correct and the connection quality. – Traceroute: Used to detect the route from the NVR to the destination IP address.
Target Address	It specifies the target address to be detected. IP address and domain name are supported.
Packet Size	It specifies the size of a single data packet. Only Ping is supported.
Packet Number	It specifies the number of data packets detected by a single Ping. It is available only when Custom Diagnosis is set to Ping .
Max. Hop	<p>It is available only when Custom Diagnosis is set to Traceroute.</p> <p>It specifies the maximum number of hops (maximum lifetime) detected by Traceroute. It means the maximum number of routes that a data packet can pass to reach the destination IP address after it leaves the LAN of the NVR.</p>

Execute One-key Diagnosis

Assume that you want to diagnose the network connectivity and network quality of all channels.

Procedures:

Step 1 [Log in to the GUI of the NVR.](#)

Step 2 Navigate to **Maintenance > Diagnosis.**

Step 3 Click **One-key Diagnosis**.

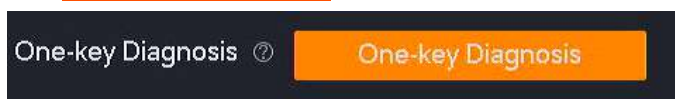

---End

The diagnosis result is displayed on the right side of the page. See the following figure.

Network Connectivity	
Gateway connectivity	Connected
Internet connectivity	Connected
Cloud service connectivity	Connected

Channel Network Quality		
Channel	Delay	PLR
D1	4.69ms	0%
D2	6.09ms	0%
D3	13.66ms	0%

Parameter description

Parameter	Description
Network Connectivity	Gateway connectivity It specifies the connectivity between the NVR and the gateway.
	Internet connectivity It specifies the connectivity of the NVR to the internet.
	Cloud service connectivity It specifies the connectivity between the NVR and the cloud platform.
Channel Network Quality	Channel It specifies the NVR channel number.

Parameter	Description
Delay	It specifies the average round-trip time taken for the data packet between the NVR and camera.
PLR	It specifies the ratio of the total number of packets lost to the total number of packets sent.

Execute Ping Command to Detect Connection Quality

Assume that you want to detect whether the link between the NVR and Facebook (www.facebook.com) is unblocked.

Procedures:

Step 1 [Log in to the GUI of the NVR.](#)

Step 2 Navigate to **Maintenance > Diagnosis**.

Step 3 Set **Custom Diagnosis**, which is **Ping** in this example.

Step 4 Enter the destination IP address or domain name, which is **facebook.com** in this example.

Step 5 Enter the ping packet size. The default value is recommended.

Step 6 Enter the number of ping packets. The default value is recommended.

Step 7 Click **Start**.

Custom Diagnosis Ping Traceroute

Target Address

Packet Size

Packet Number

---End

The diagnosis result is displayed on the right side of the page. See the following figure.

```
PING 218.93.250.18 (218.93.250.18): 56 data bytes

Ping statistics for 218.93.250.18:
Packets: Sent = 4, Received = 0, Lost = 4 (100% loss)
Approximate round trip times in milli-seconds:
Minimum = 0.0ms, Maximum = 0.0ms, Average = 0.0ms
```

Execute Traceroute Command to Detect Connection Quality

Assume that you want to detect whether the link between the NVR and Facebook (www.facebook.com) is unblocked.

Procedures:

- Step 1** [Log in to the GUI of the NVR.](#)
- Step 2** Navigate to **Maintenance > Diagnosis**.
- Step 3** Set **Custom Diagnosis**, which is **Traceroute** in this example.
- Step 4** Enter the destination IP address or domain name, which is **facebook.com** in this example.
- Step 5** Enter the number of hops. The default value is recommended.
- Step 6** Click **Start**.

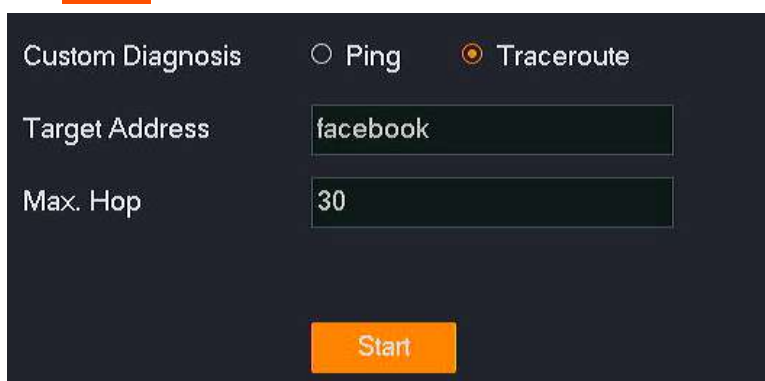

Custom Diagnosis Ping Traceroute

Target Address facebook

Max. Hop 30

Start

---End

The diagnosis result is displayed on the right side of the page. See the following figure.

```

traceroute to facebook (218.93.250.18), 31 hops max, 38 byte packets
 1 192.168.0.1 (192.168.0.1) 0.225 ms 0.169 ms 0.143 ms
 2 172.16.200.1 (172.16.200.1) 1.080 ms 0.872 ms 0.676 ms
 3 192.168.20.1 (192.168.20.1) 1.728 ms 1.543 ms 1.620 ms
 4 192.168.21.254 (192.168.21.254) 1.537 ms 0.977 ms 0.885 ms
 5 113.87.160.1 (113.87.160.1) 18.380 ms 3.145 ms 2.640 ms
 6 233.106.38.59.broad.fs.gd.dynamic.163data.com.cn (59.38.106.233) 4.617 ms 229.106.3
 8.59.broad.fs.gd.dynamic.163data.com.cn (59.38.106.229) 10.058 ms 14.147.74.33 (14.147
 7 14.147.127.105 (14.147.127.105) 3.939 ms 14.147.127.85 (14.147.127.85) 7.690 ms *
 8 202.97.42.202 (202.97.42.202) 29.558 ms 202.97.29.74 (202.97.29.74) 44.325 ms 202.97.
 2.33 (202.97.2.33) 30.013 ms
 9 61.147.248.18 (61.147.248.18) 29.262 ms 61.147.245.74 (61.147.245.74) 34.923 ms 61.1
 47.245.90 (61.147.245.90) 36.783 ms
10 222.187.235.201 (222.187.235.201) 51.313 ms 45.905 ms *
11 61.147.244.126 (61.147.244.126) 55.602 ms 61.147.244.90 (61.147.244.90) 39.826 ms 4

```

4.7.6 Device Maintenance

Navigate to **Maintenance > Device Maintenance**.

You can perform maintenance operations on the NVR here, such as enabling or disabling SSH debugging, scheduled reboot, restoring default settings, and restoring factory settings.

SSH Debugging

Secure Shell (SSH) is a protocol used to realize secure remote access and file transfer services through encryption mechanisms and authentication mechanisms. This NVR supports SSH server function and accepts SSH client connections.

By default, SSH debugging is disabled.

After SSH debugging is enabled, you can log in to the NVR through the SSH client. The SSH debugging is only used by professionals to debug the NVR. For security, please do not enable this function unless special situation.

SSH Debugging



Set Scheduled Reboot

The scheduled reboot can prevent performance decrease and instability of the NVR due to long-time running. You can set the NVR to automatically reboot periodically during idle time, for example, set the NVR to automatically reboot at 3:00:00 from Monday to Friday.

Procedures:

- Step 1** [Log in to the GUI of the NVR.](#)
- Step 2** Navigate to **Maintenance > Maintenance.**
- Step 3** Enable the **Scheduled Reboot** function.
- Step 4** Select reboot date, which is **Monday to Friday** in this example.
- Step 5** Set automatic reboot time of the NVR, which is **03:00:00** in this example.
- Step 6** Click **Save** at the bottom of the page.

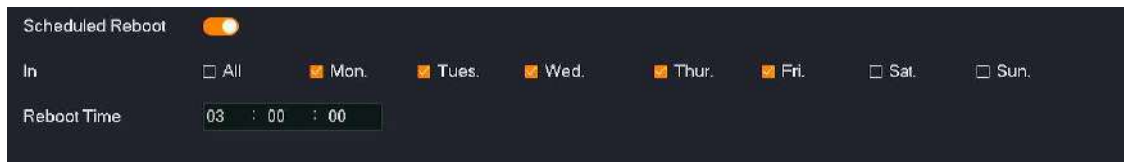

---End

After the setting completes, the NVR will automatically reboot from Monday to Friday at 3 am.

Restore Settings

If the NVR is running slowly, or a configuration error occurs, you can try to restore the NVR.

- Restore the default settings: Except for the network configuration and user management-related configuration, all other settings are restored to the factory settings.
- Restore factory settings: Restore all settings of the NVR to the factory settings.

NOTE .

- When the NVR restores its settings, it will disconnect all current connections.
- Restoring the settings will not delete recordings and log information.
- To avoid damaging the NVR, please ensure that the NVR is powered on properly during the process of restoring the factory settings.

Procedures:

Step 1 [Log in to the GUI of the NVR.](#)

Step 2 Navigate to **Maintenance > Device Maintenance.**

Step 3 Click **Restore Default Settings** or **Restore Factory Settings** according to the actual situation.

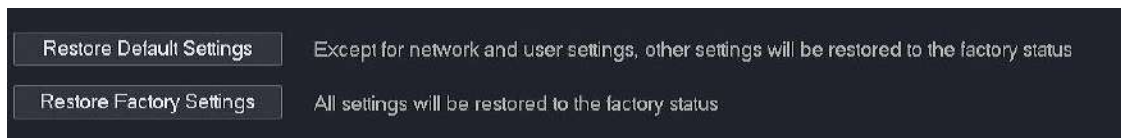

Step 4 Read the prompt message, and click **OK**.

---End

Wait until the progress bar completes.

5 Web Management

5.1 Web Login

Scenario 1: With DHCP Server in the Network

Step 1 Connect the computer to the switch or router that is connected to the NVR.

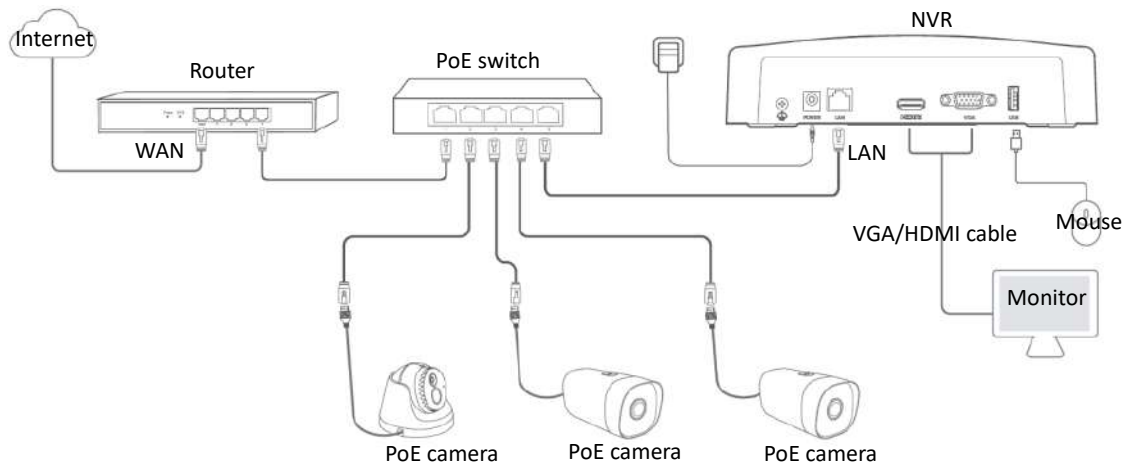

Step 2 Log in to the web UI of the DHCP to view the IP address of the NVR.

Step 3 Start a web browser on the computer, input the IP address (which is 192.168.0.188 in this example) of the NVR in the address bar.

The NVR supports HTTPS secure login. When you access the web UI of the NVR, the browser may prompt that the address is not safe, just ignore it and continue. Here takes Google Chrome as an example, please click **Advanced** → **Proceed to 192.168.0.188** (unsafe).

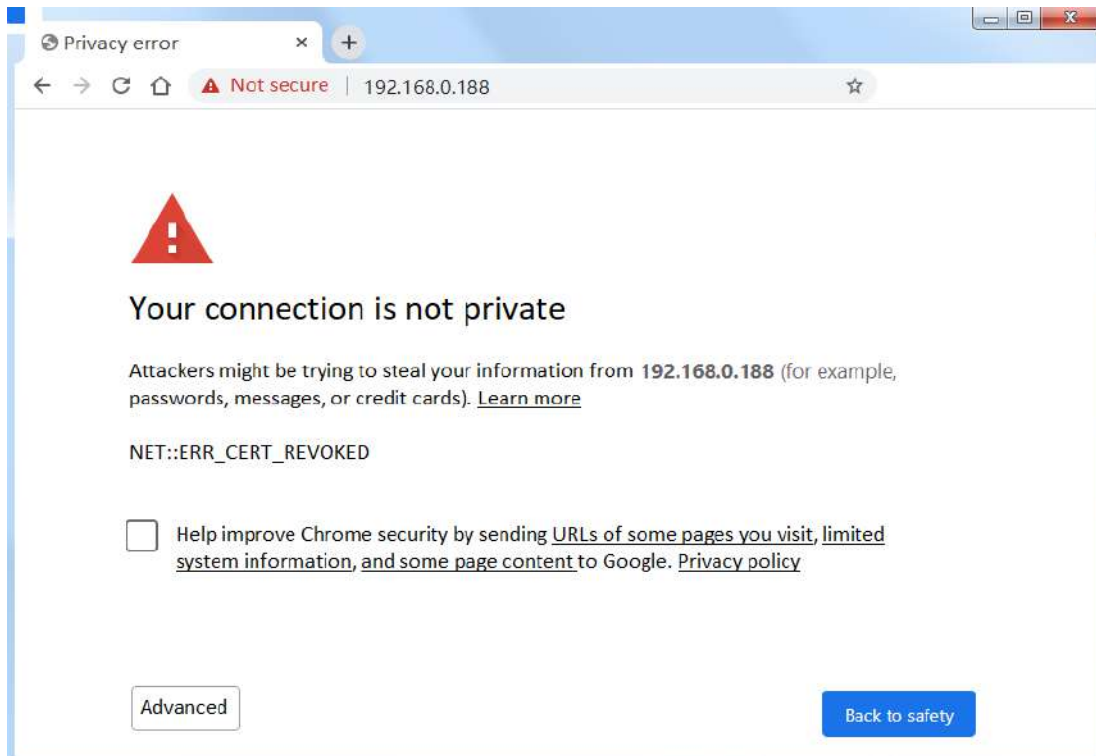

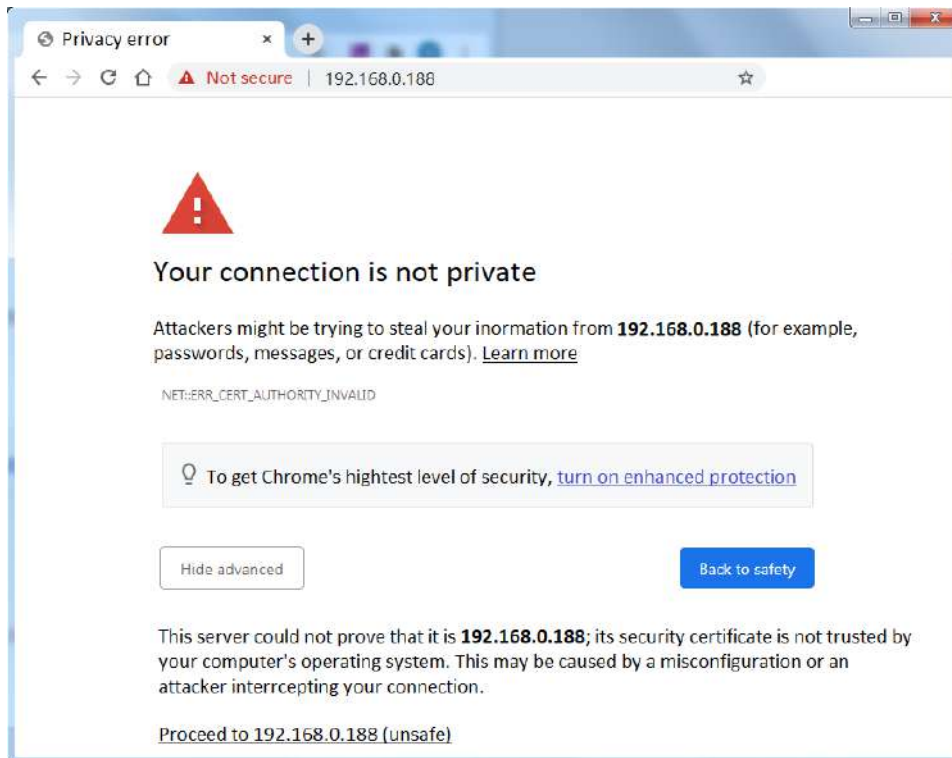

Step 4 Enter the **Login User Name** and **Login Password**, and click **Login**.

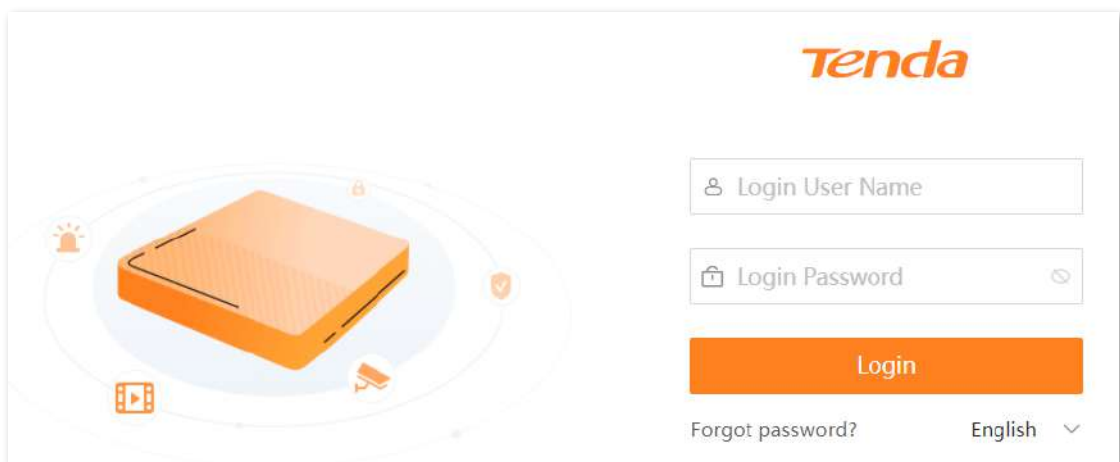

---End

After you successfully log in to the web UI of the NVR, you can preview real-time videos or configure as required.

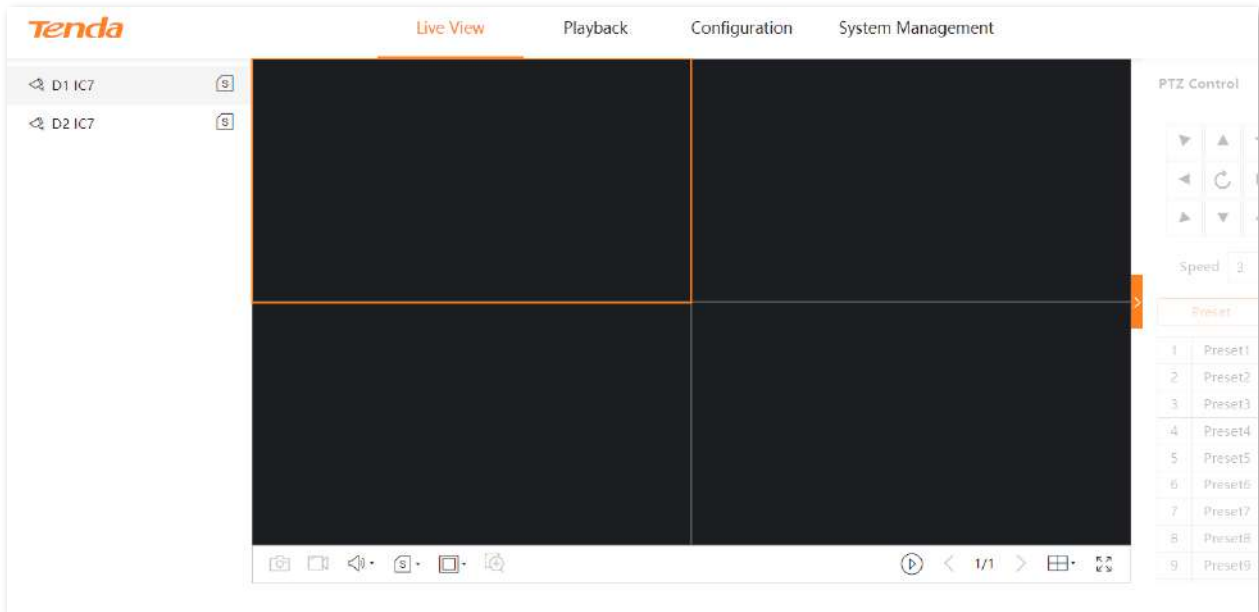

Scenario 2: Without DHCP Server in the Network

Step 1 Connect the computer to the switch or router that is connected to the NVR.

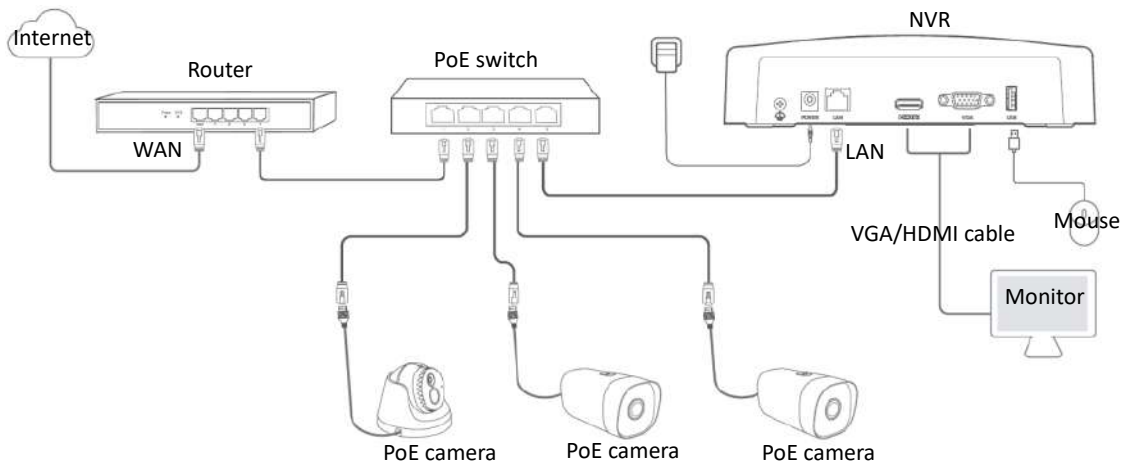

- Step 2** Set the IP address of the computer to an unused one belonging to the same network segment of the IP address (default: 192.168.1.254) of the NVR but different from the IP address of the NVR.

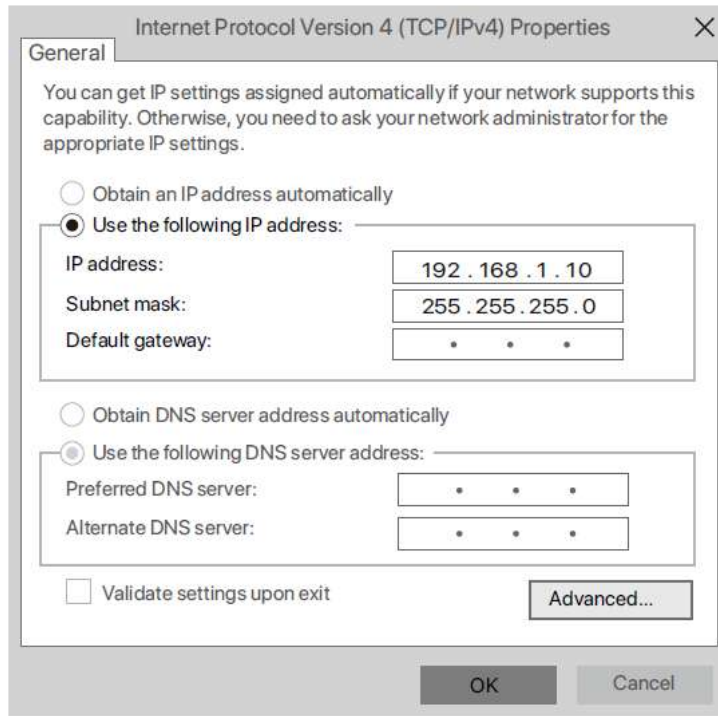

Step 3 Start a web browser on the computer, input the IP address of the NVR (default: 192.168.1.254).

The NVR supports HTTPS secure login. When you access the web UI of the NVR, the browser may prompt that the address is not safe, just ignore it and continue. Here takes Google Chrome as an example, please click **Advanced** → **Proceed to 192.168.1.254 (unsafe)**.

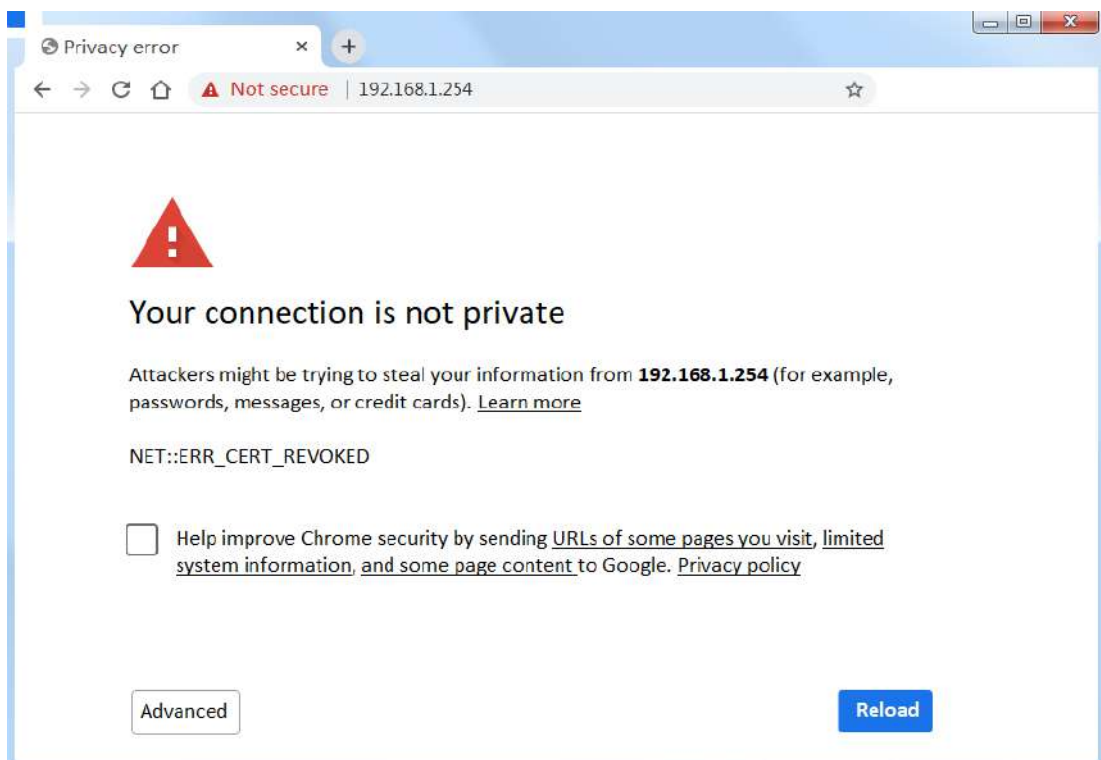

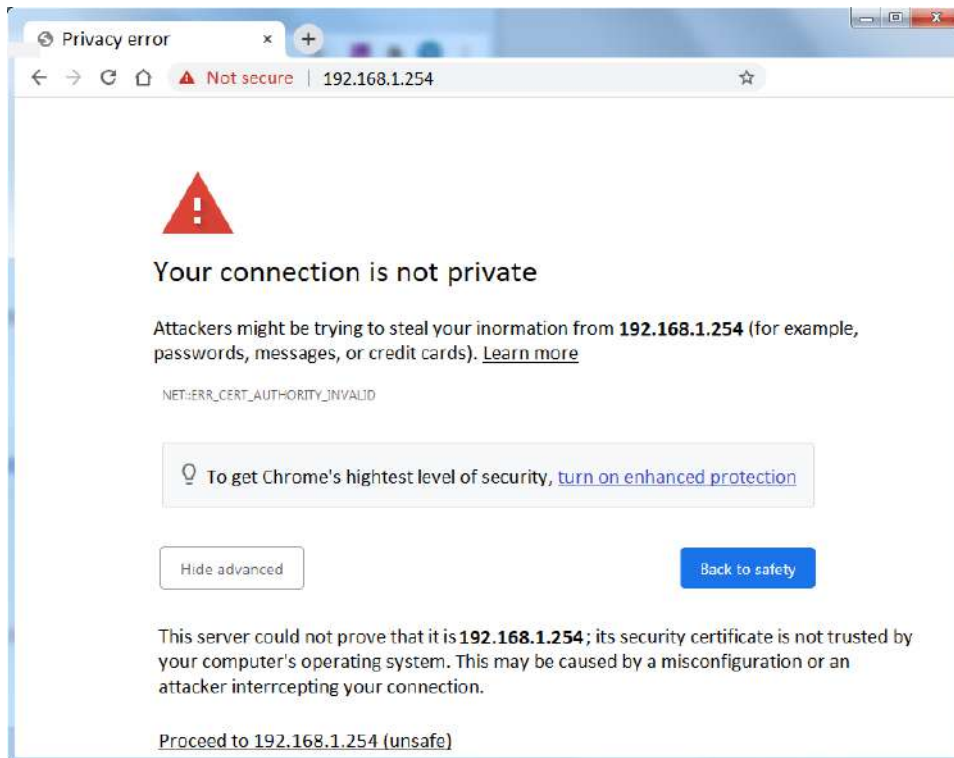

Step 4 Enter the **Login User Name** and **Login Password**, and click **Login**.

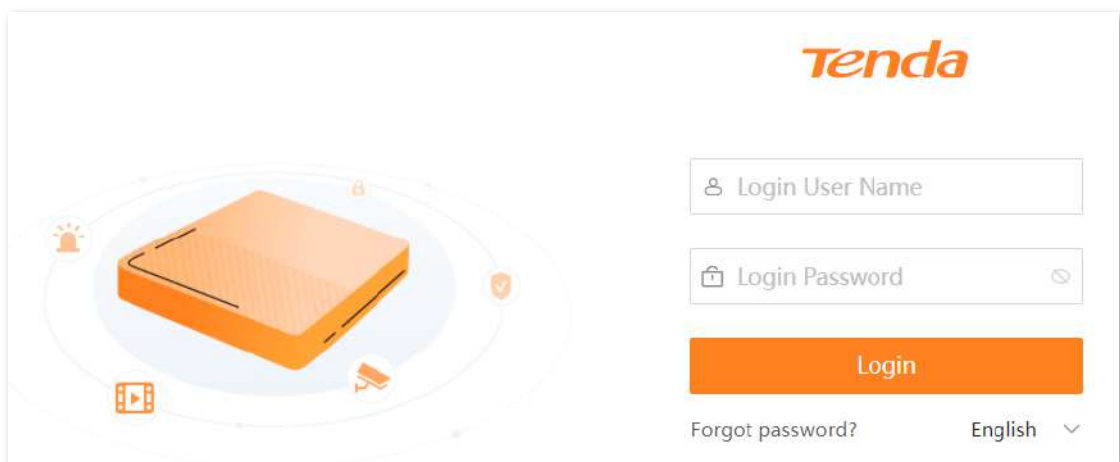

---End

After you successfully log in to the web UI of the NVR, you can preview real-time videos or configure as required.

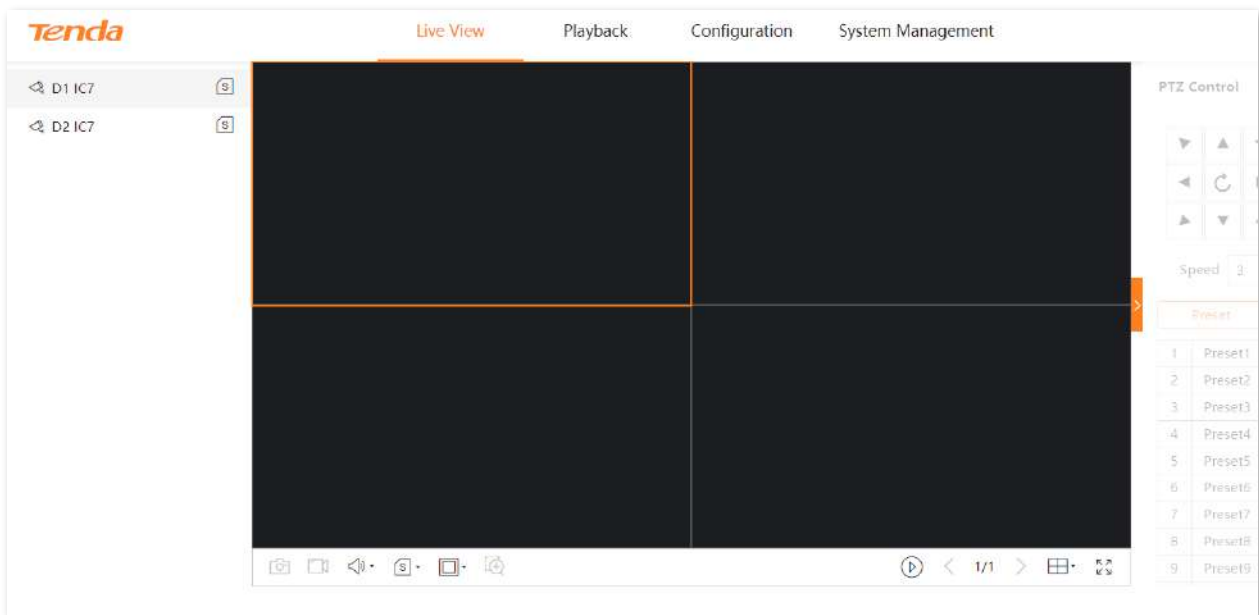

5.2 Live View

5.2.1 Overview

Click **Live View** to enter the page.





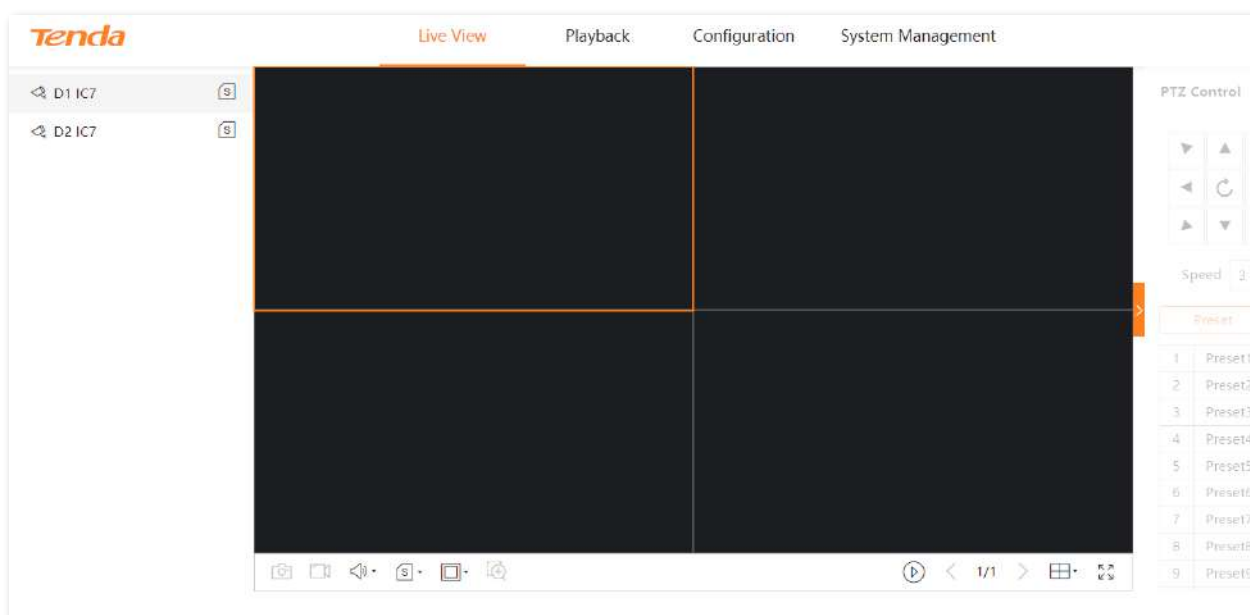

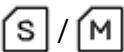

The default page is the live view page after you enter the web UI of the NVR. The number of window divisions of devices varies with different models. The actual model prevails. In this section, you can check the monitoring image of each channel, and perform such basic management as switch division mode, recording and PTZ control for the channel or camera.

Some description of parameter and function are as follows. Please refer to the [Live View](#) of the GUI chapter for other content.

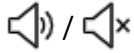
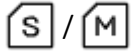
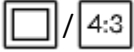

Parameter description

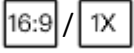
Parameter	Description
	It specifies the icon of the camera. Double-click the icon to start/stop the preview of this channel. By default, the preview is not performed. A green dot icon at the upper-right of the icon indicates that the monitoring image is being previewed.
	Click it to check or set the stream of a single channel. It is located on the left side of the page.

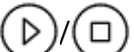
Parameter	Description
	<p>Capture.</p> <p>Click it to take a screenshot of the currently selected monitoring image of the channel and save it to the local computer.</p>
	<p>Recording.</p> <p>Click  to start recording the monitoring image, and click  to stop recording. The recorded files will be automatically saved to the local computer.</p>
	<p>Click it to adjust the video volume of all channels.</p>
	<p>Click it to set the stream of all online channels. It is located at the bottom of the page.</p>
	<p>Click it to adjust the ratio of the monitoring image display, or display the monitoring image in its original size ().</p>
	
	<p>Area zoom-in.</p> <p>Click it to select a specific area of the channel to zoom in this area through the mouse. Click it again to stop zooming in.</p> <p>Refer to Zoom in function of web UI chapter for details.</p>
	<p>Click it to start/stop previewing all channel monitoring.</p>
PTZ Control	<p>It specifies the monitoring direction and patrol of PTZ cameras or domes that can be managed. Only PTZ cameras can be edited.</p> <p>Please refer to PTZ Control of the GUI chapter for details.</p>

5.2.2 Preview the Monitoring Image of Each Channel

Preview the Monitoring Image of Single Channel

Assume that you want to preview the monitoring image of D3.

Procedures:

Step 1 [Log in to the web UI of the NVR.](#)

Step 2 Click **Live View**, then double-click the channel on the left side, which is D3 in this example.

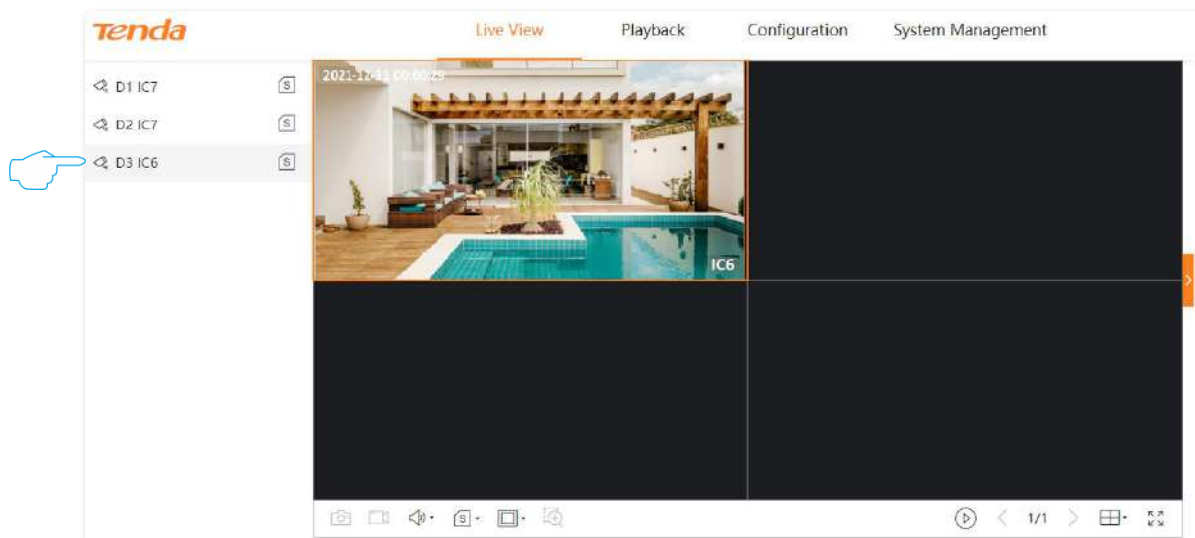

---End

Preview the Monitoring Image of All Channel

Assume that you want to preview the monitoring image of all channels.

Procedures:

Step 1 [Log in to the web UI of the NVR.](#)

Step 2 Click **Live View**, then click  at the bottom of the page.

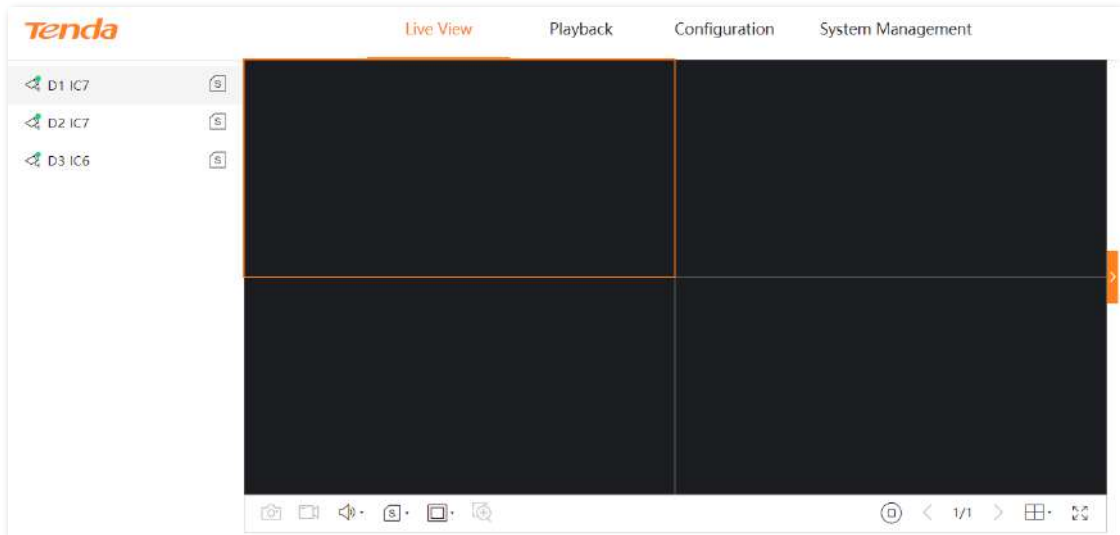

---End

The monitoring image of all channels is previewed successfully.

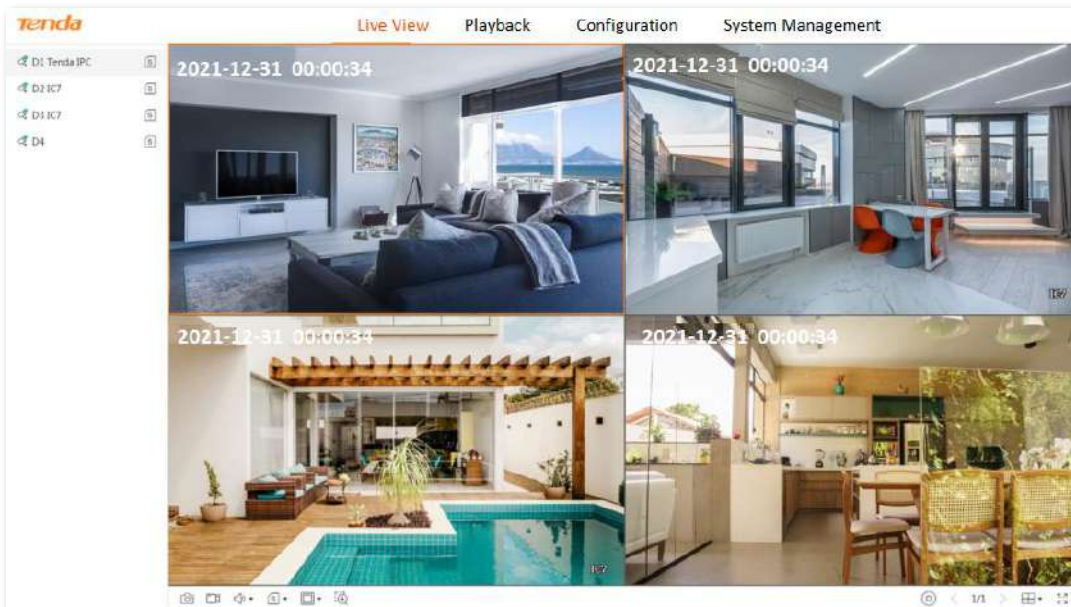

5.2.3 Zoom in

The zoom-in function enables you to zoom in a specific area of the monitoring image to check the details.

Procedures:

- Step 1** [Log in to the web UI of the NVR.](#)
- Step 2** Click **Live View**.
- Step 3** Select the channel you want to zoom in the monitoring image, which is D3 in this example.
- Step 4** Click  at the bottom of the page.

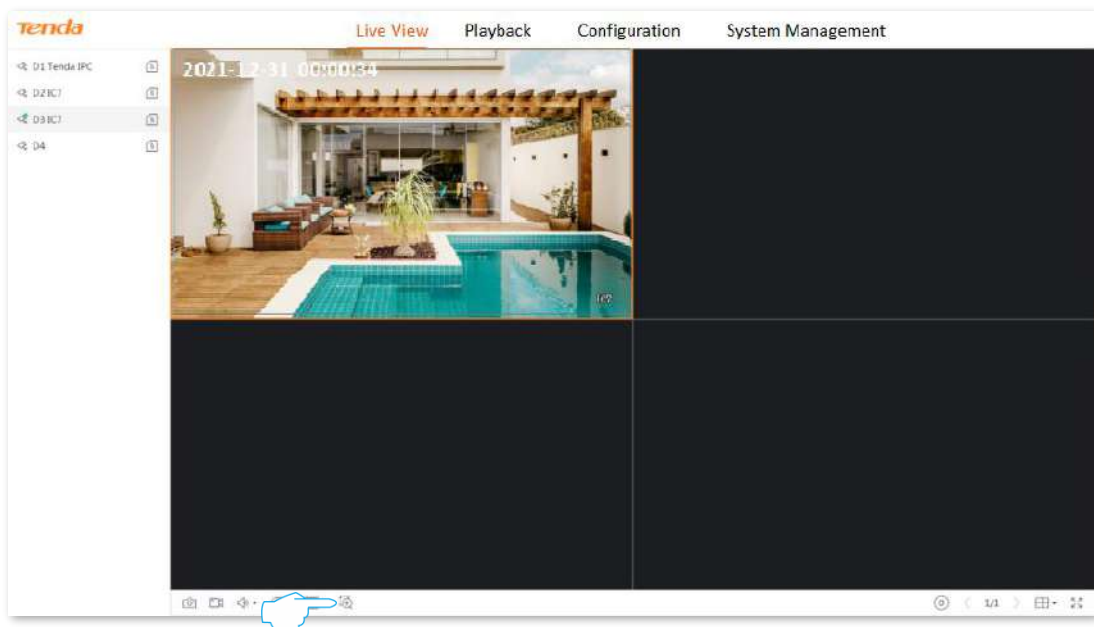

Step 5 Use the mouse to select the area you want to zoom in.

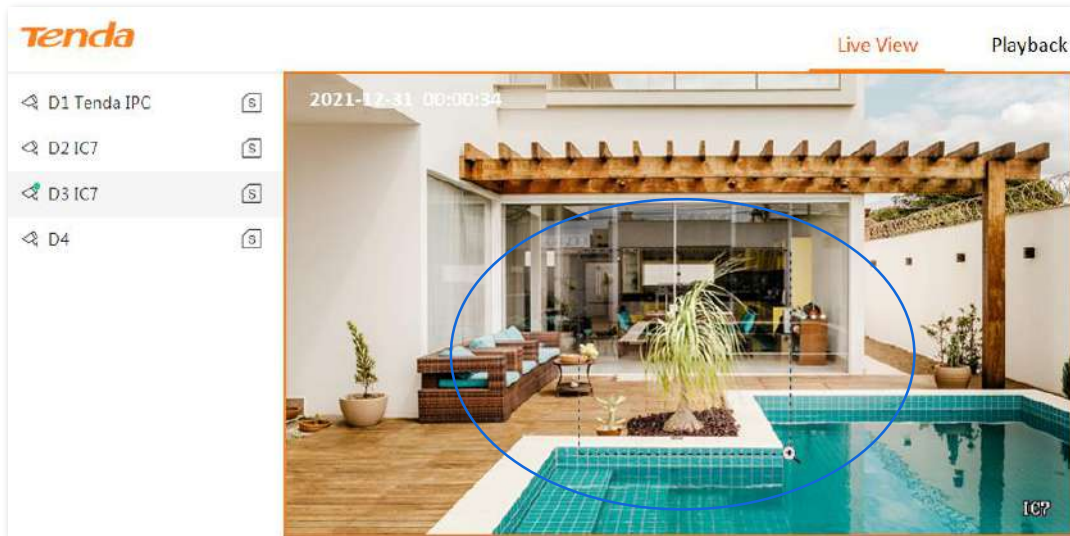

---End

The area is zoomed in successfully. You can check the details of this area.

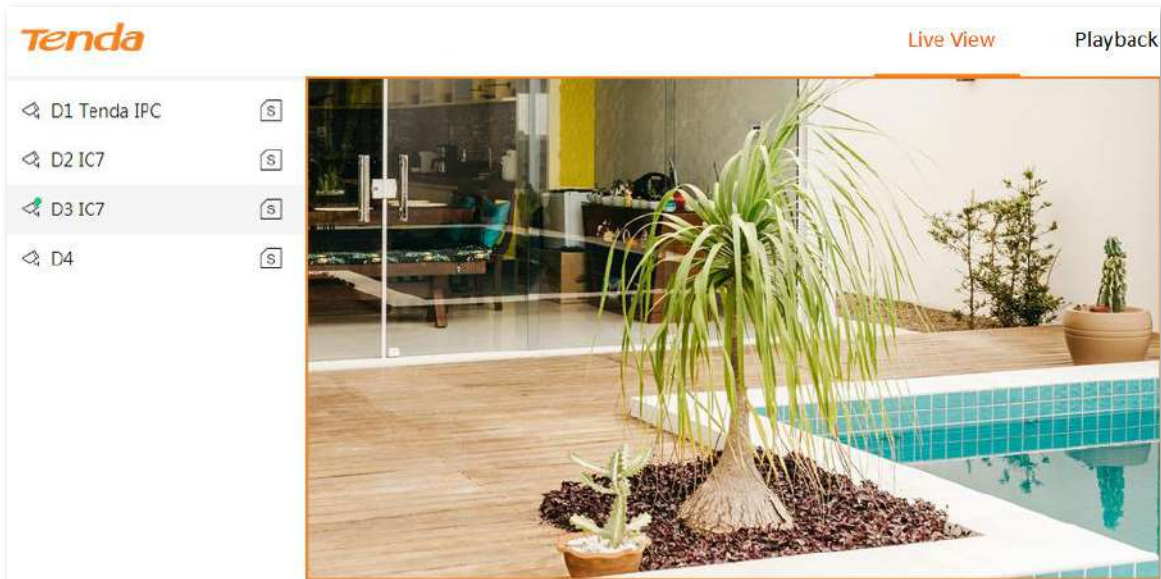

5.3 Playback

5.3.1 Overview



Click **Playback** to enter the page.

The channel playback is supported for now. It indicates that you can search and play back the corresponding recording file according to the channel and date. You can perform such operations as check, capture, clip and export for recording files as required.

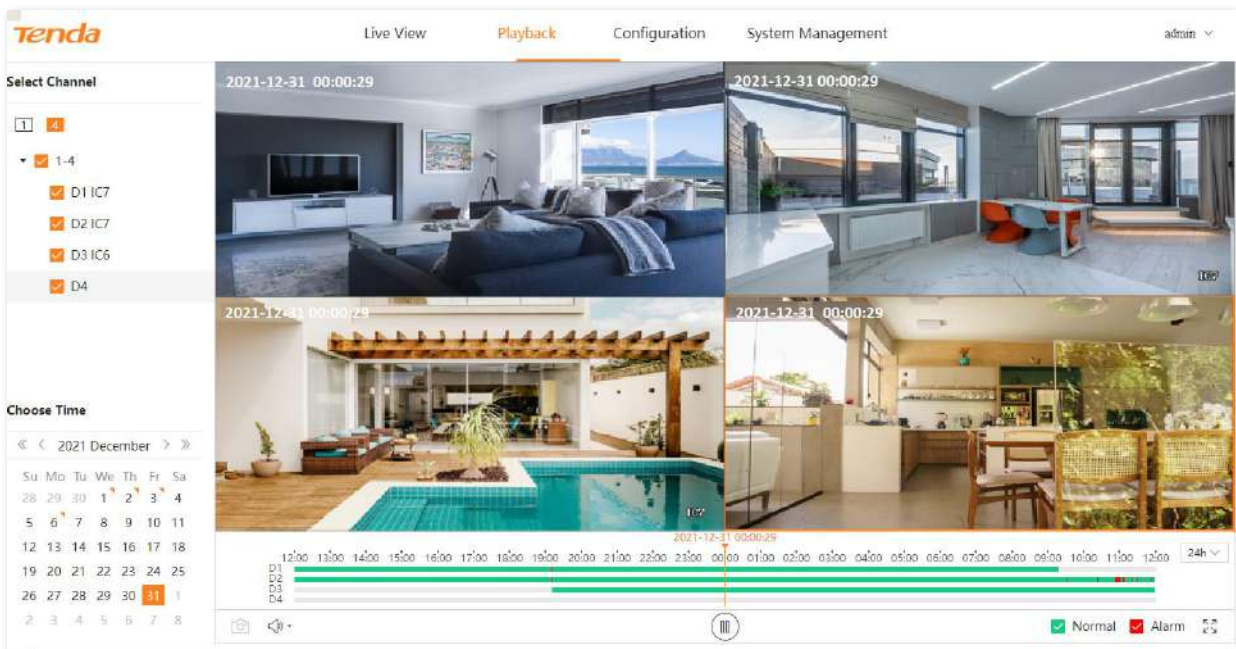
Some description of parameter and function are as follows, please refer to the [Playback](#) of the GUI chapter for more content.



Parameter description

Parameter	Description
Time Bar	<p>It specifies the recording and time under the current filter conditions.</p> <ul style="list-style-type: none"> – Use the mouse to drag the time bar to left or right, and the playback interface will start to play back from the time point of the time bar. – The time bar color varies with recoding file types. Green means normal recording and red means alarm recording. <p> TIP</p> <p>Up to 4 channels can be displayed. If you select more than 4 channels, only the currently selected channel will be displayed.</p>
	<p>Capture.</p> <p>Take a screenshot of the currently selected monitoring image of the channel and save it to the local computer.</p>

5.3.2 Play Back the Specific Channel

Assume that you want to play back the recordings of D1 to D4 on December 31, 2021.

Procedures:

Step 1 [Log in to the web UI of the NVR.](#)

Step 2 Click **Playback**, and then click .

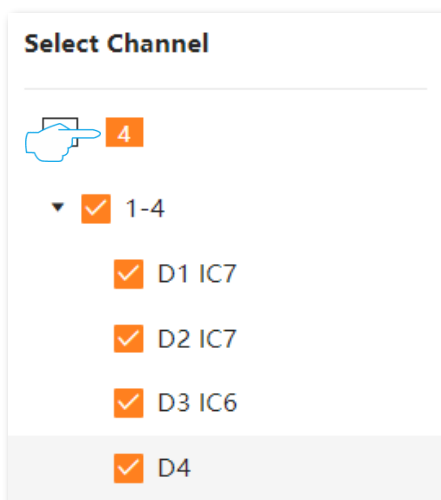

Step 3 Select the date, which is **December 31, 2021** in this example.

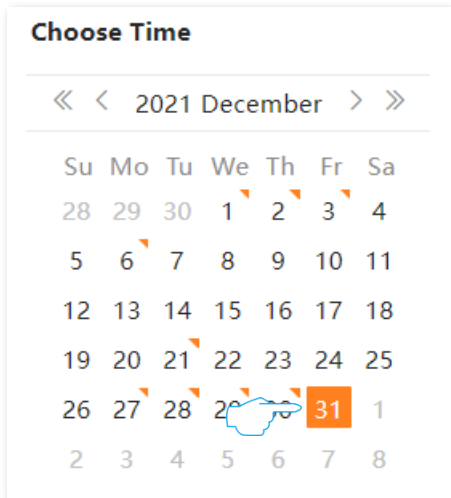

Step 4 Edit the time bar and play back control area as required to play back the recordings.



---End

5.4 Configuration

On the configuration page, you can configure such main function parameters as channel management, storage management, alarm management and network configuration of the device.

5.4.1 Channel

Navigate to **Configuration > Channel**.

You can manage the camera, configure OSD display, image and video parameters here. Please refer to the [Channel Management](#) of the GUI chapter for more content.

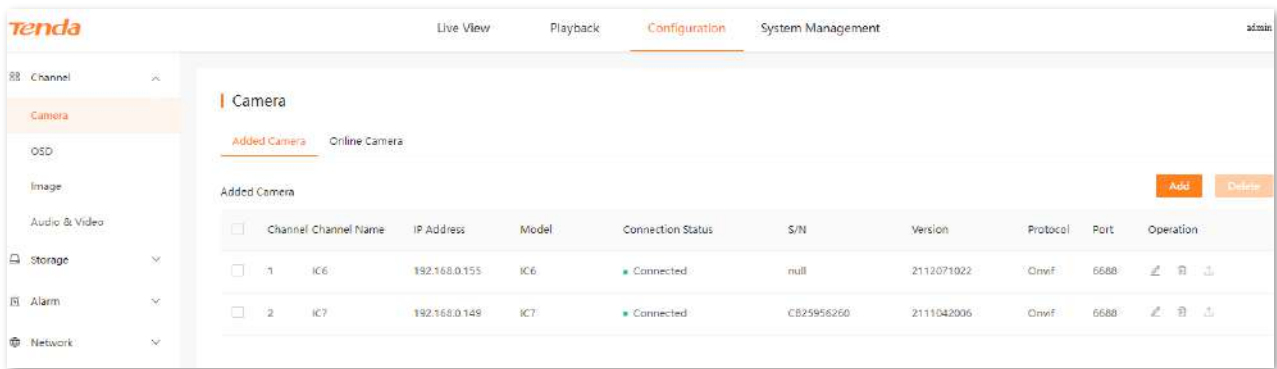

5.4.2 Storage Management

HDD Management

Navigate to **Configuration > Storage > HDD**.

You can check the HDD status, format the HDD, and make a storage strategy when the HDD space is not enough. Please refer to the [HDD Management](#) of the GUI chapter for details.



Schedule

Overview

Navigate to **Configuration > Storage > Schedule**.

The system will record according to the recording schedule. By default, the system presets the recording schedule of 24 hours continuous normal recording of each channel.

You can modify the recording time and recording type as required. Some description of parameter and function is as follows, please refer to the [Schedule](#) of the GUI chapter for more content.

Schedule

Channel:

Recording:

Normal
 Alarm

0 1 2 3 4 5 6 7 8 9 10 11 12 13 14 15 16 17 18 19 20 21 22 23 24



Mon.																									
Tues.																									
Wed.																									
Thur.																									
Fri.																									
Sat.																									
Sun.																									

Tip: 8 periods are supported for one day at most

Advanced >>

Parameter & button description

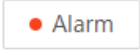
Parameter	Description
<input checked="" type="radio"/> Normal	Green means normal recording. It specifies the NVR always records. Click this button to draw the normal recording time in the period when the recording schedule is not configured.

Parameter	Description
	Red means alarm recording. It specifies the NVR will only record when the camera triggers an alarm. Click this button to draw the alarm recording time in the period when the recording schedule is not configured.
Time Bar	Click it to edit the recording type and the recording time, and also to delete the recording period.
	Click it to synchronize the recording schedule of the current week to other days in the week.
	Click it to clear the current recording schedule.
Post-record	Only applicable for Alarm . Click Advanced to enter the page. It specifies the time of continuous recording after an alarm is finished.

Configure Schedule

Assume that you want to set a schedule for D1, D2, D3, and D4 cameras as shown in the table below:

Recording	Recording Time	Recording Type
Monday to Sunday	00:00 to 8:00	Not recording
Monday to Sunday	8:00 to 12:00	Alarm recording
Monday to Sunday	12:00 to 14:00	Normal recording
Monday to Sunday	14:00 to 18:00	Alarm recording
Monday to Sunday	18:00 to 24:00	Normal recording



After an alarm recording plan is set for the corresponding channel, the alarm event also needs to be set for the channel in the [Alarm Recording](#).

Step 1 [Log in to the web UI of the NVR.](#)

Step 2 Navigate to **Configuration > Storage > Schedule.**

Step 3 Set the recording schedule of the D1 camera.

1. Select **Channel** as **D1**, and ensure that **Recording** function is enabled.
2. Set the recording schedule for **Monday**.
 - (1) Click **Monday**, then drag the time bar.

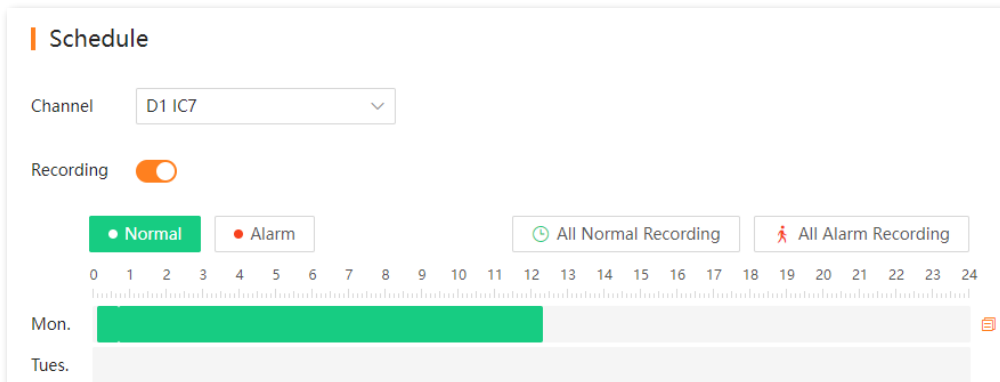

- (2) Set the first alarm recording period, which is 8:00 to 12:00 in this example. Select **Alarm** and set the arming schedule, see the following figure. Click **OK**.

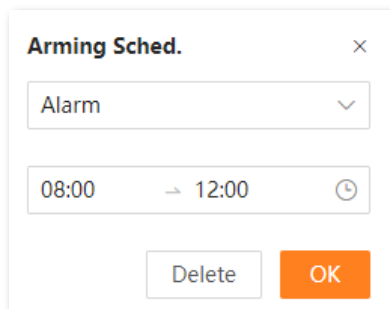

- (3) Set the second alarm recording period, which is 14:00 to 18:00 in this example. Click **Alarm**, and then hold down the left mouse button and drag to draw the recording period on the corresponding time on the Monday time bar.



If the drawn time is not accurate, you can click the period after the drawing is completed, and then select the time again in the pop-up window.

- (4) Refer to step (3) to set a normal recording schedule, which is 12:00 to 14:00 and 18:00 to 24:00 in this example.
- (5) Click **Save**.

3. Set the recording schedule for Tuesday to Sunday.

(1) Click  behind the Monday time bar.

(2) Select other days in the week to synchronize the recording schedule of Monday, Which is **Tuesday to Sunday** in this example (You can also tick **All.**), and click **OK**.

(3) Click **Save**.

Schedule

Channel: D1 IC7

Recording:

Normal Alarm

Day	0	1	2	3	4	5	6	7	8	9	10	11	12	13	14	15	16	17	18	19	20	21	22	23	24
Mon.	Normal							Alarm		Normal		Alarm		Normal											
Tues.	Normal							Alarm		Normal		Alarm		Normal											
Wed.	Normal							Alarm		Normal		Alarm		Normal											
Thur.	Normal							Alarm		Normal		Alarm		Normal											
Fri.	Normal							Alarm		Normal		Alarm		Normal											
Sat.	Normal							Alarm		Normal		Alarm		Normal											
Sun.	Normal							Alarm		Normal		Alarm		Normal											

Tip: 8 periods are supported for one day at most

Advanced >>

Step 4 Set the recording schedule of other channel cameras.

1. Click at the bottom of the page, then select the channel you want to synchronize the D1 camera recording schedule, which is **D2** to **D4** in this example. (You can also tick **All**.)
2. Click **Sync**.

Sync to

All D1 D2 D3

---End

After the setting completes, the system will record to D1, D2, D3 and D4 according to the above schedule.

5.4.3 Alarm Recording

Motion Detection

Navigate to **Configuration > Alarm > Motion Detection**.

Motion detection refers to the detection alarm of moving targets. When a moving target appears on the monitoring image and the moving sensitivity reaches the preset value, the system will alarm and record according to the linkage action you set.

Some description of parameter and function are as follows. Please refer to the [Motion Detection](#) of the GUI chapter for more content.

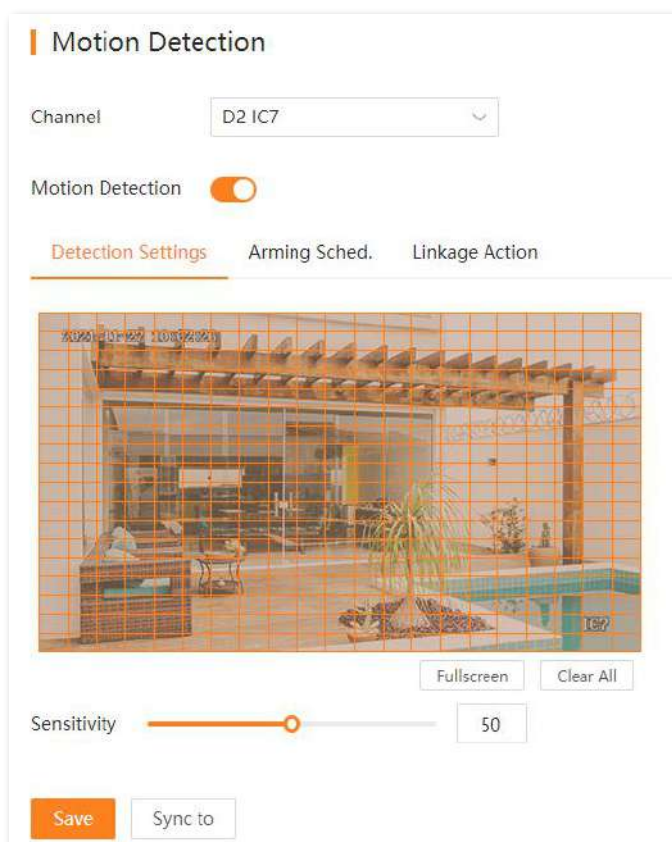

Parameter description

Parameter	Description
Time Bar	Click it to edit the recording type and recording time, or delete the recording period.
Arming Sched.	 Click it to sync the recording schedule of the current week to other days in the week.

Parameter	Description
<div style="text-align: center;"> <input type="button" value="Clear"/> </div>	<p>Click it to clear the arming schedule of the current channel.</p>
Linkage Action	<p>Linkage Action</p> <p>It specifies the alarm method of the NVR after an alarm is triggered.</p> <ul style="list-style-type: none"> - Single Screen Display: The alarm channel is displayed on a single screen on the Live View page after an alarm is triggered. - Send Email: The system will send an alarm email to the preset receiver email after an alarm is triggered. You need to set the relevant parameters of email for this alarm method to take effect. Please refer to Email Configuration for details. - Message Notification: The system will send an alarm notification to TDSEE App after an alarm is triggered. The NVR needs to be added successfully through TDSEE App. Please refer to Manage the NVR through TDSEE App for details.

Exception Detection

Navigate to **Configuration > Alarm > Exception Detection**.

Exception detection refers to the detection and alarm of exception events. When an exception event occurs, the system will be alarmed according to the linkage action you set.

Some description of parameter and function are as follows. Please refer to the [Exception Detection](#) of the GUI chapter for more content.

Exception Detection

Exception Type

Linkage Action Monitor pop-up window Send Email Message Notification

Parameter description

Parameter	Description
Linkage Action	<p>It specifies the alarm method of the NVR after an alarm is triggered.</p> <ul style="list-style-type: none"> – Single Screen Display: The alarm channel is displayed on a single screen on the Live View page after an alarm is triggered. – Send Email: The system will send an alarm email to the preset receiver email after an alarm is triggered. You need to set the relevant parameters of email for this alarm method to take effect. Please refer to Email Configuration for details. – Message Notification: The system will send an alarm notification to TDSEE App after an alarm is triggered. The NVR needs to be added successfully through TDSEE App. Please refer to Manage the NVR through TDSEE App for details.

5.4.4 Network Configuration

Navigate to **Configuration > Network**. The N6P-4H is taken as an example here.

On the network configuration page, you can perform the network configuration, including internet settings, cloud service, PoE configuration, port configuration, email configuration, DDNS and UPnP. Please refer to the [Network Configuration](#) of the GUI chapter for details.

The screenshot displays the Tenda web interface for network configuration. The top navigation bar includes 'Live View', 'Playback', 'Configuration' (selected), and 'System Management'. The left sidebar lists various settings categories, with 'Internet' highlighted. The main configuration area for 'Internet' includes:

- DHCP:** Enabled (toggle switch).
- IP Address:** 192 . 168 . 0 . 188
- Subnet Mask:** 255 . 255 . 255 . 0
- Default Gateway:** 192 . 168 . 0 . 1
- Auto Obtain DNS:** Enabled (toggle switch).
- Primary DNS:** 192 . 168 . 0 . 1
- Secondary DNS:** 0 . 0 . 0 . 0
- MTU:** 1500
- MAC Address:** 50:2b:73:f9:09:40

A 'Save' button is positioned at the bottom right of the configuration area.

5.5 System Management

5.5.1 Device Info

Navigate to **Configuration > Device Info > Device Info**.

You can check such basic information as device name, device model, firmware version, firmware release time and system time of the NVR.

Please refer to the [Device Info](#) of the GUI chapter for details.

Device Info	
Device Name	Tenda NVR
Device Model	N3L-4H
Device S/N	2106C5110100000025
Version	V12.1.3.9
Release Date	2021-12-22
System Time	2022-01-04 14:23:01
Uptime	0day(s)0hour(s)45minute(s)

5.5.2 Device Log

Navigate to **Configuration > Device Info > Device Log**.

The system log records such information as running status, configuration information, alarm information, exception conditions of the system. You can use system logs for viewing alarm information and troubleshooting. It is recommended to check and back up logs regularly.

Please refer to the [System Log](#) of the GUI chapter for details.

Device Log

Type: All Time: 2022-01-04 00:00:00 → 2022-01-04 23:59:59 Search Export Log

No.	Time	Type	Detail
1	2022-01-04 13:37:39	Operation	{ "Shutdown Time": "2000-00-00 00:00:00" }
2	2022-01-04 13:37:41	Operation	{ "Disk": "1", "Flag": "1" }
3	2022-01-04 13:37:42	Exception	{ "Channel": "4" }
4	2022-01-04 13:37:45	Exception	{ "Channel": "1", "Result": "Disconnect", "State": "5" }
5	2022-01-04 13:44:41	Operation	{ "Session": "2" }

5 items in total 10

5.5.3 System Configuration

Basic Settings

Navigate to **System Management** > **System Settings** > **Basics**.

You can configure such basic parameters as the device name and output resolution of the NVR.

Please refer to the [Basic Configuration](#) of the GUI chapter for details.

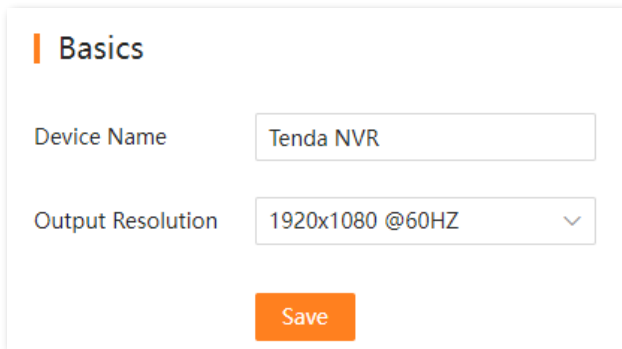

The screenshot displays the 'Basics' configuration page. It features a title 'Basics' with a vertical bar icon. Below the title, there are two configuration items: 'Device Name' with a text input field containing 'Tenda NVR', and 'Output Resolution' with a dropdown menu showing '1920x1080 @60HZ'. At the bottom of the configuration area, there is an orange 'Save' button.

Time

Navigate to **System Management > System Settings > Time**.

You can configure the system time of the NVR. To ensure that the time-based functions of the NVR take effect normally, the system time of the NVR must be accurate.

Please refer to the [Time Settings](#) of the GUI chapter for details.

Time

System Time 2022-01-04 14:59:23

Time Zone (UTC+08:00) Beijing, Chongqing

Date Format YYYY-MM-DD

Time Synchronization Manual Internet

Server Address time.windows.com

Port 123

Interval 10 minute(s) (range: 1 - 10080)

DST

Type Date Week

Start Time January 1 0:00

End Time January 1 0:00

Offset Time 60 minute(s)

Save

5.5.4 System Maintenance

Device Upgrade

Navigate to **System Management > System Maintenance > Device Upgrade**.

The firmware upgrade enables the NVR to get new or more stable performance. The NVR only supports **Local Upgrade** for now.



- To avoid damage to the NVR, please use the correct upgrade file to upgrade. Generally, the suffix of the firmware upgrade file is .bin.
- During upgrading, do not directly cut off the power supply of the NVR; it may cause upgrade failure or damage the NVR.

Upgrade firmware:

Step 1 [Log in to the web UI of the NVR.](#)

Step 2 Navigate to **System Management > System Maintenance > Device Upgrade**.

Step 3 (If you have got the upgrade file, skip this step) Click **Tenda Download Center**, and then download the latest upgrade file of the corresponding model NVR to the local computer and unzip it.

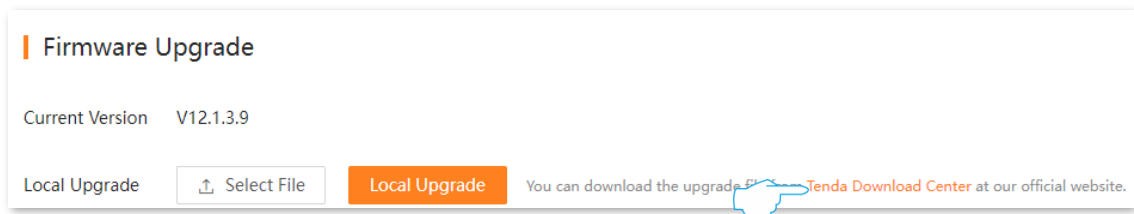

Step 4 Click **Select File**.

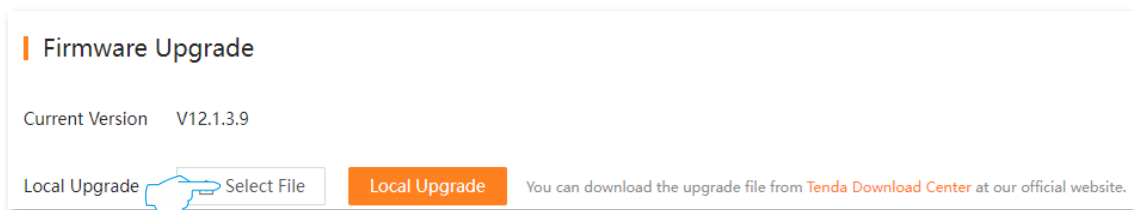

Step 5 Target the firmware file downloaded previously, and click **Open**. The following figure is for reference only.

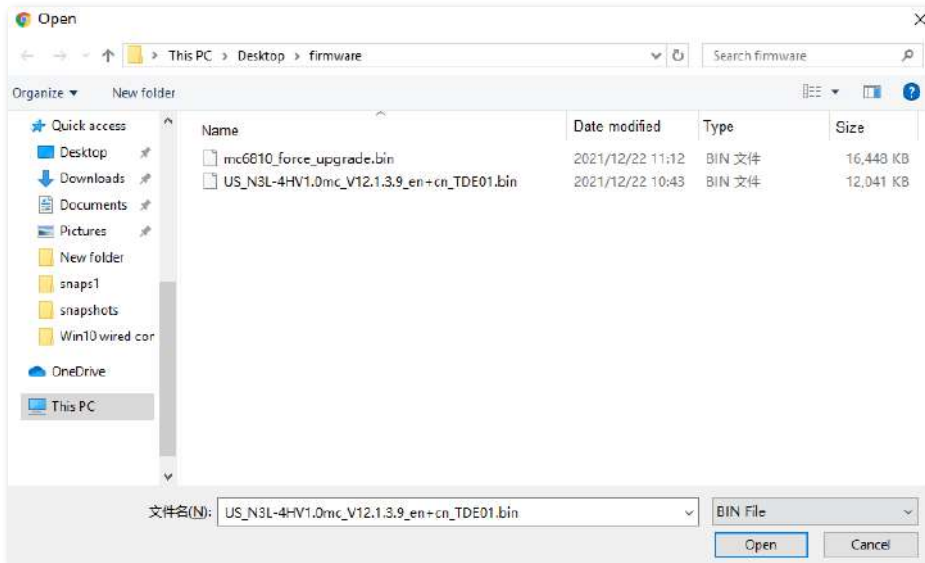

Step 6 Click **Local Upgrade**.

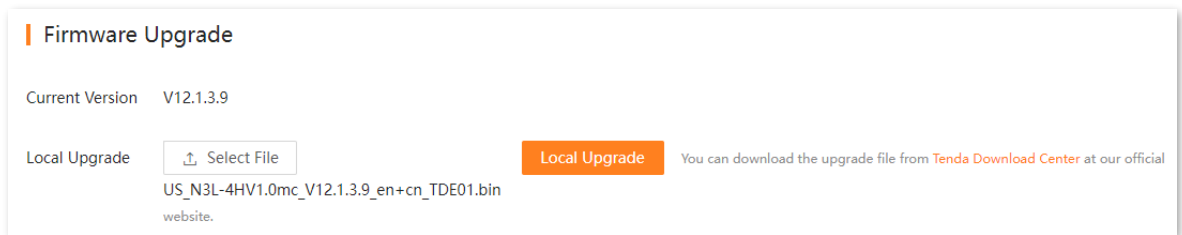

---End

Wait for a moment until the ongoing process finishes. After the upgrade completes, log in to the web UI of the NVR again, and check the **Current Version** on the **Firmware Upgrade** page to confirm whether the firmware version is correct.

Configuration Management

Navigate to **System Management > System Maintenance > Configuration Mgmt.**

If the NVR is running slowly, or a configuration error occurs, you can try to restore the NVR.

Please refer to the [Restore Settings](#) of the GUI chapter for details.

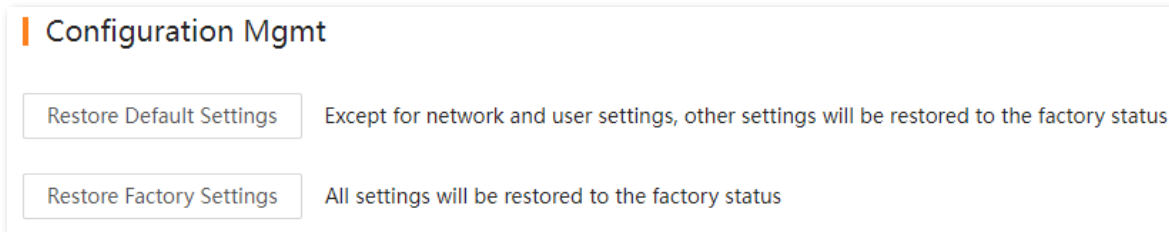

Reboot Settings

Navigate to **System Management > System Maintenance > Reboot Settings.**

The reboot can prevent performance decrease and instability of the NVR due to long-time running. You can reboot the NVR now, or set the NVR to automatically reboot periodically during idle time.

Assume that you want to the NVR to automatically reboot at 3:00:00 from Monday to Friday.

Procedures:

- Step 1** [Log in to the web UI of the NVR.](#)
- Step 2** Navigate to **System Management > System Maintenance > Reboot Settings.**
- Step 3** Enable the **Scheduled Reboot** function.
- Step 4** Select reboot date, which is **Monday to Friday** in this example.
- Step 5** Set automatic reboot time of the NVR, which is **03:00:00** in this example.
- Step 6** Click **Save** at the bottom of the page.

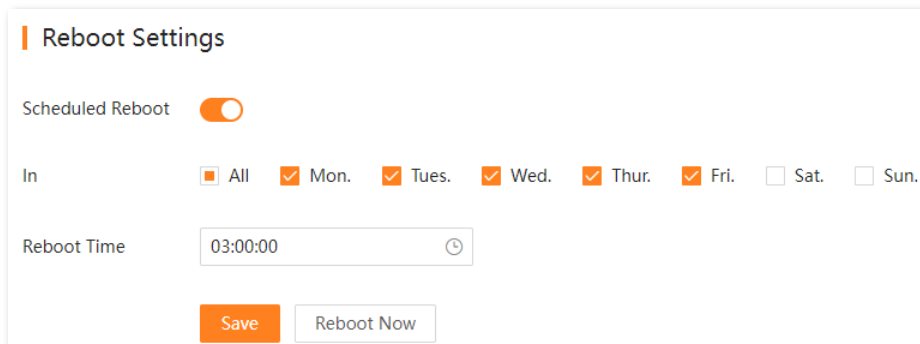

---End

After the setting completes, the NVR will automatically reboot from Monday to Friday at 3 am.

System Service

Navigate to **System Management > System Maintenance > System Service**.

You can configure the SSH debugging function here.

Please refer to the [SSH Debugging](#) of the GUI chapter for details.

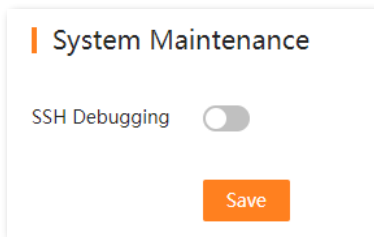

5.5.5 User Management

Navigate to **System Management > Users**.

You can modify and add the login account information of the NVR here to prevent unauthorized users from entering the GUI of the NVR to change the settings.

Please refer to the [User Management](#) of the GUI chapter for details.



Appendix

Acronyms and Abbreviations

Acronym or Abbreviation	Full Spelling
CBR	Constants Bits Rate
DDNS	Dynamic Domain Name Server
DHCP	Dynamic Host Configuration Protocol
DNS	Domain Name System
GUI	Graphical User Interface
HTTP	HyperText Transfer Protocol
IMAP	Internet Message Access Protocol
IP	Internet Protocol
ISP	Internet Service Provider
LAN	Local Area Network
MAC	Medium Access Control
MTU	Maximum Transmission Unit
VBR	Variable Bit Rate
NAT	Network Address Translation
NTP	Network Time Protocol
ONVIF	Open Network Video Interface Forum
OSD	on-screen display
SATA	Serial Advanced Technology Attachment

Acronym or Abbreviation	Full Spelling
SMTP	Simple Mail Transfer Protocol
SSH	Secure Shell
SSID	Service Set IDentifier
SSL	Secure Sockets Layer
TCP	Transmission Control Protocol
TLS	Transport Layer Security
UDP	User Datagram Protocol
UI	User Interface
UTC	Coordinated Universal Time
UPnP	Universal Plug and Play
VBR	Variable Bit Rate
Wi-Fi	Wireless Fidelity