

CA12240/UPS

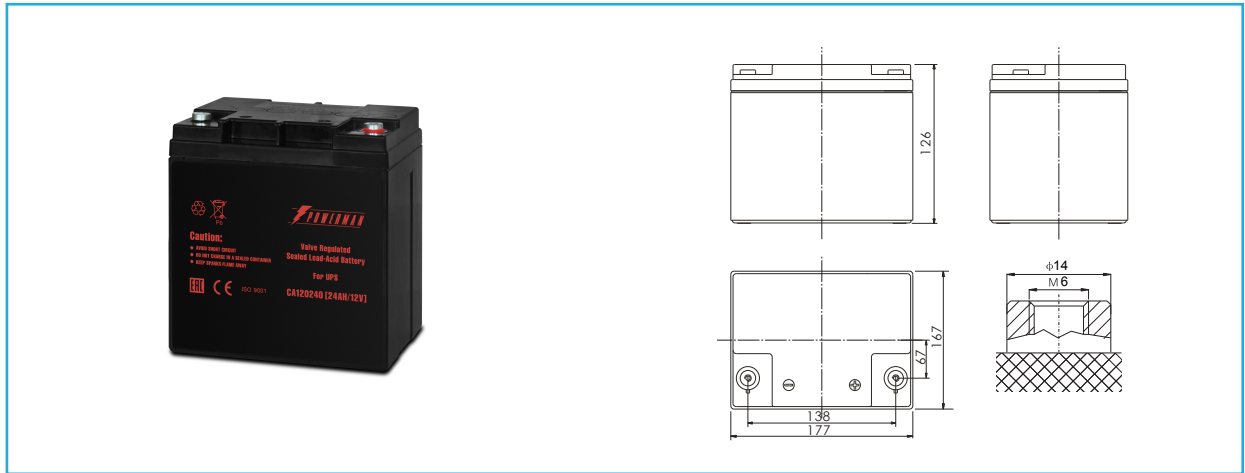

Specifications

Nominal Voltage		12V
Rated Capacity(20 hour rate)		24Ah
Dimensions	Total Height (with terminals)	6.85inches(174mm)
	Height	6.85inches(174mm)
	Length	6.54inches(166mm)
	Width	4.96inches(126mm)
Weight		Approx. 18.48pound(8.4kg)

Characteristics

Capacity 77°F(25°C)	20 hour rate (1.20A)	24Ah
	10 hour rate (2.23A)	22.3Ah
	5 hour rate (3.84A)	19.2Ah
	1 hour rate (14.4A)	14.4Ah
	15 minute Rate (42.2 A)	10.55Ah
Internal Resistance	Full charged Battery 77°F(25°C)	12mΩ
Capacity affected by Temperature (20 hour rate)	104°F(40°C)	102%
	77°F(25°C)	100%
	32°F(0°C)	85%
	5°F(-15°C)	65%
Self-Discharge 77°F(20°C)	Capacity after 3 month storage	91%
	Capacity after 6 month storage	81%
	Capacity after 12 month storage	60%
Max. Discharge Current 77°F(25°C)	360A(5S)	
Terminal	B1/M1	
Charge (Constant Voltage)	Cycle	Initial Charging Current less than 7.2A
		Voltage 14.4~14.7V/77°F(25°C)
	Float	Voltage 13.5~13.8V/77°F(25°C)

Discharge Curves 77°F (25°C)

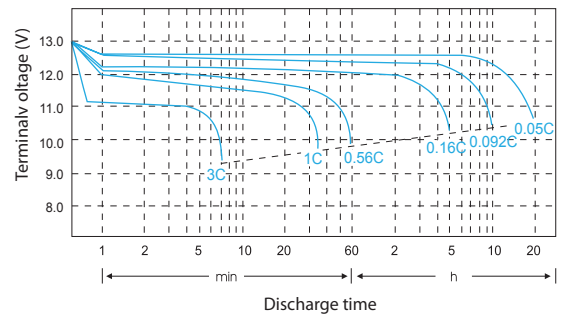

Relationship between charge voltage and temperature

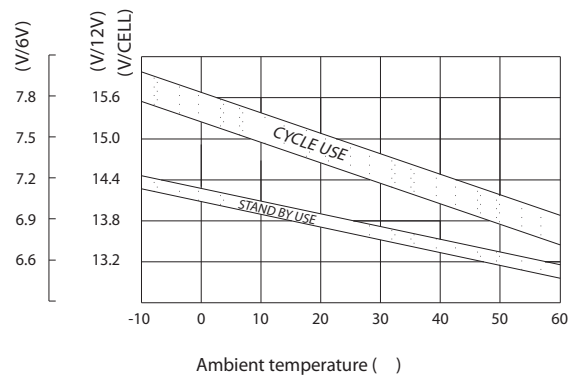

Constant Current Discharge (AMPERES @25°C)

F.V/Time	5Min	10Min	15Min	30Min	60Min	2H	3H	4H	5H	10H	20H
9.60	91.44	58.08	46.56	25.92	15.84	8.95	6.17	4.94	4.18	2.28	1.22
9.90	89.28	56.40	44.88	25.20	15.43	8.64	6.10	4.90	4.16	2.26	1.21
10.20	85.20	54.00	43.44	24.72	15.00	8.52	6.03	4.85	4.13	2.24	1.21
10.50	81.60	51.84	41.76	24.48	14.64	8.40	6.00	4.80	4.08	2.24	1.20
10.80	76.80	51.36	39.60	23.76	14.16	8.16	5.90	4.68	4.03	2.19	1.18

Constant Power Discharge (WATTS PER CELL@25°C)

F.V/Time	5Min	10Min	15Min	30Min	60Min	2H	3H	4H	5H	10H	20H
9.60	1018.64	652.82	528.92	295.49	182.79	104.63	73.34	58.88	49.78	27.27	14.60
9.90	995.47	634.50	510.29	288.54	178.39	101.07	72.60	58.41	49.67	27.06	14.55
10.20	950.83	608.04	494.35	283.29	173.55	99.85	71.84	57.89	49.32	26.85	14.50
10.50	911.47	584.76	475.65	280.79	169.53	98.62	71.58	57.36	48.80	26.86	14.45
10.80	858.62	580.37	451.49	272.76	164.26	95.88	70.55	55.97	48.28	26.26	14.20

CA12240/UPS

The operating environment temperature above 40°C should be avoided. After long term storage, The battery actual capacity would be less than the rated capacity. Full capacity will be obtained through several charge/discharge cycles. To get the longest life, POWERMAN battery should be fully charged before storage.

Cycle service life in relation to depth of discharge

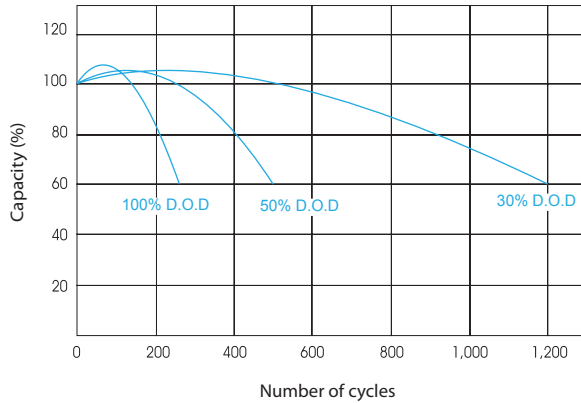

Constant voltage charge characteristic

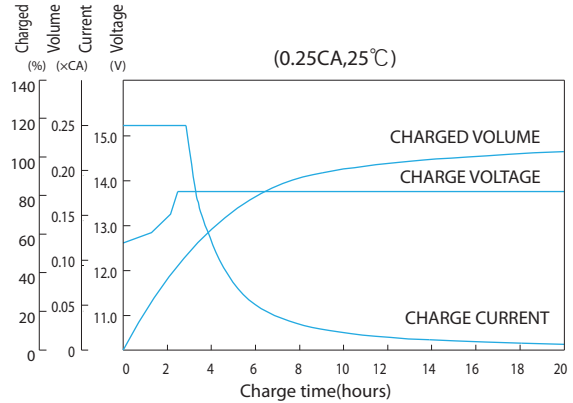

Self-Discharge Characteristics

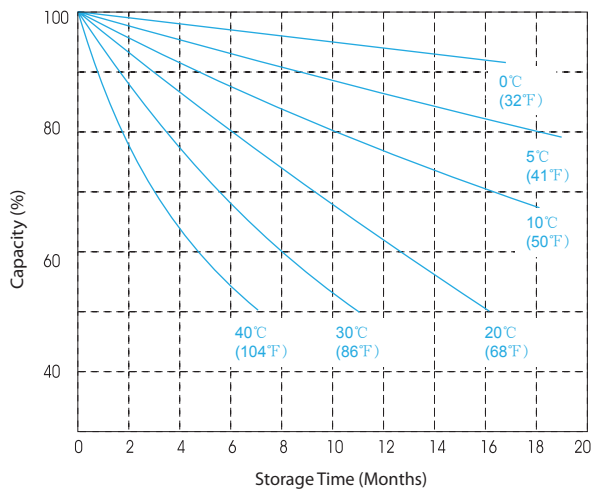

Relationship of OCV and Residual Capacity % (25°C)

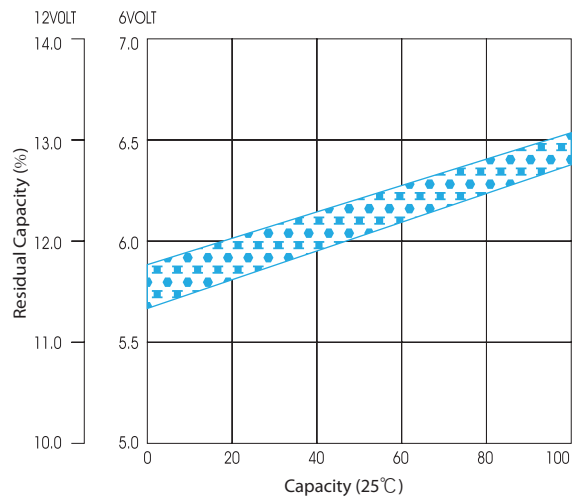

Temperature effects on capacity

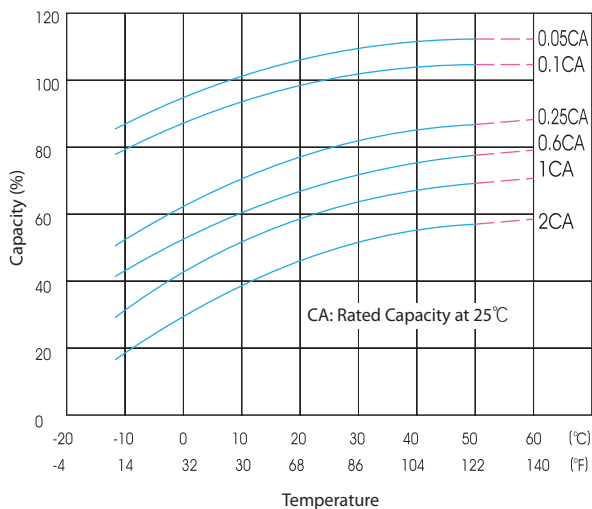

Temperature effects float life

