

# Инструкция по установке

## LADA XRAY

(2015-)



Арт.: F.6015.002

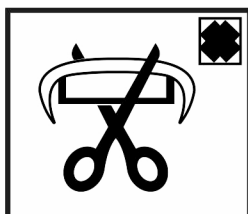
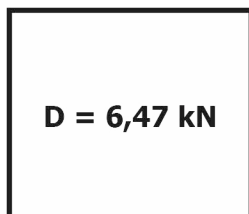
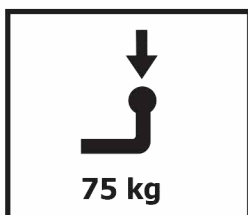
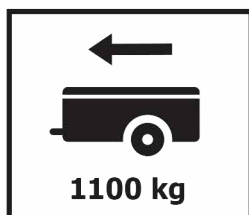

$$D \text{ (kN)} = \frac{\text{MAX kg} \times \text{MAX kg}}{\text{MAX kg} + \text{MAX kg}} \times 0,00981$$

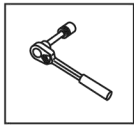

Вкрутить/выкрутить используя инструмент

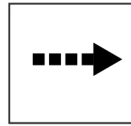

Движение

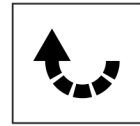

Поворот



Вкрутить/выкрутить не затягивая

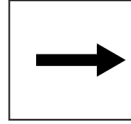

Расположение

## Используемый инструмент:

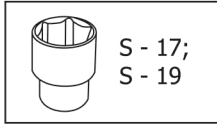
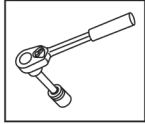





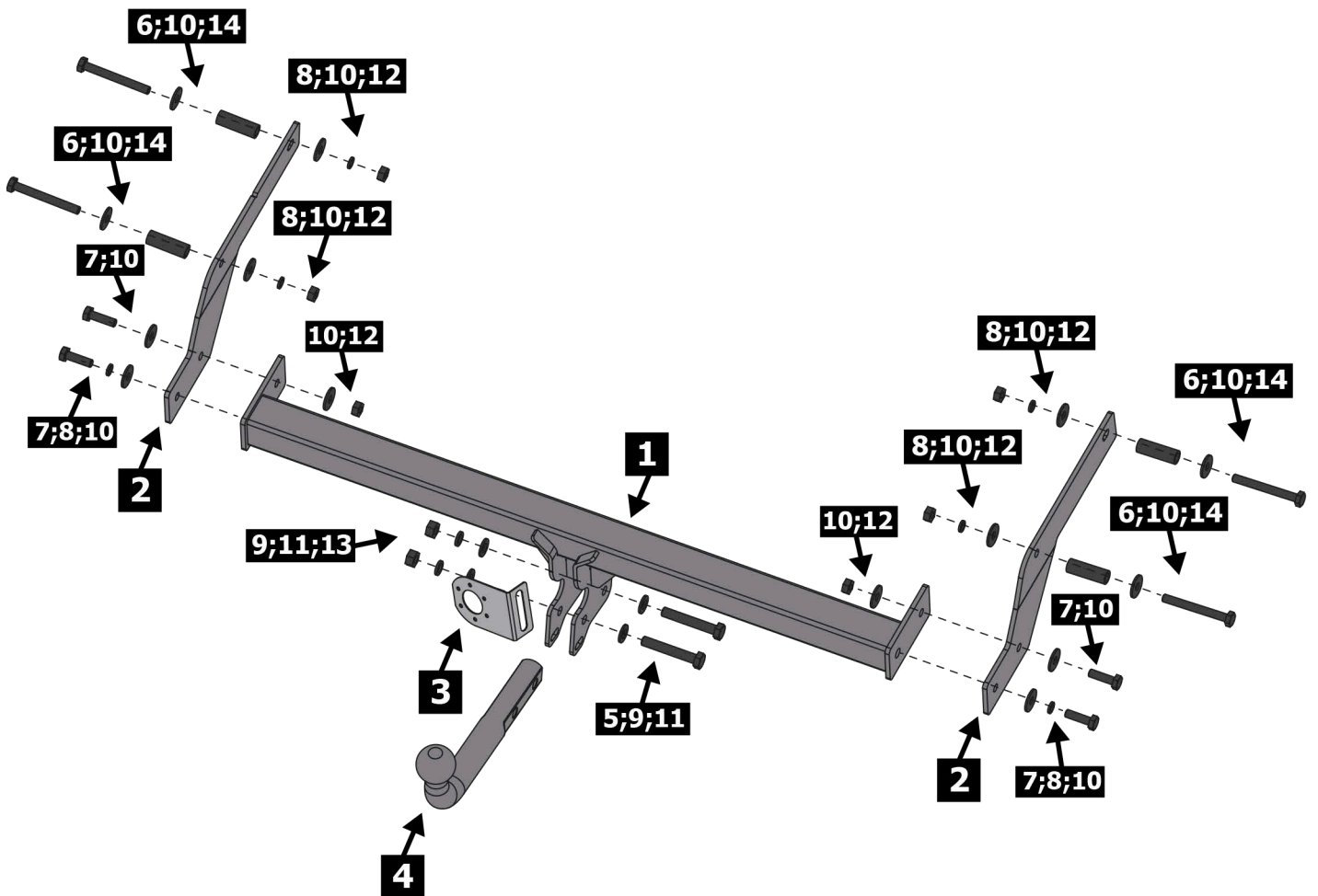

S - 17;  
S - 19

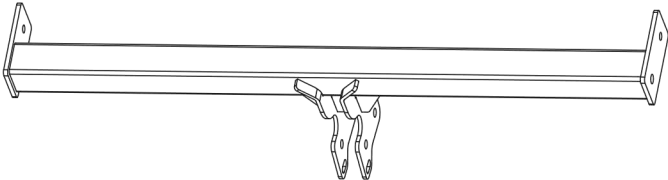
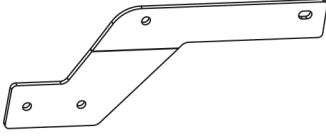
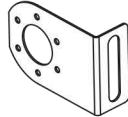
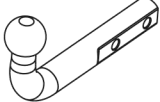
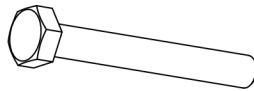
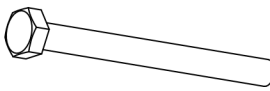
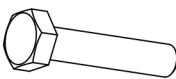

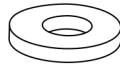
TORX 30;  
TORX 20

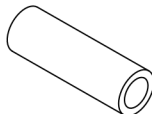

<b>1</b>	x1	Балка	
<b>2</b>	x2	Кронштейн	
<b>3</b>	x1	Подрозетник	
<b>4</b>	x1	Крюк	
<b>5</b>	x2	M12x75	
<b>6</b>	x4	M10x90	
<b>7</b>	x4	M10x35	
<b>8</b>	x6	∅ 10	
<b>9</b>	x2	∅ 12	
<b>10</b>	x14	∅ 10	
<b>11</b>	x4	∅ 12	
<b>12</b>	x6	M10	
<b>13</b>	x2	M12	
<b>14</b>	x4	Втулка	

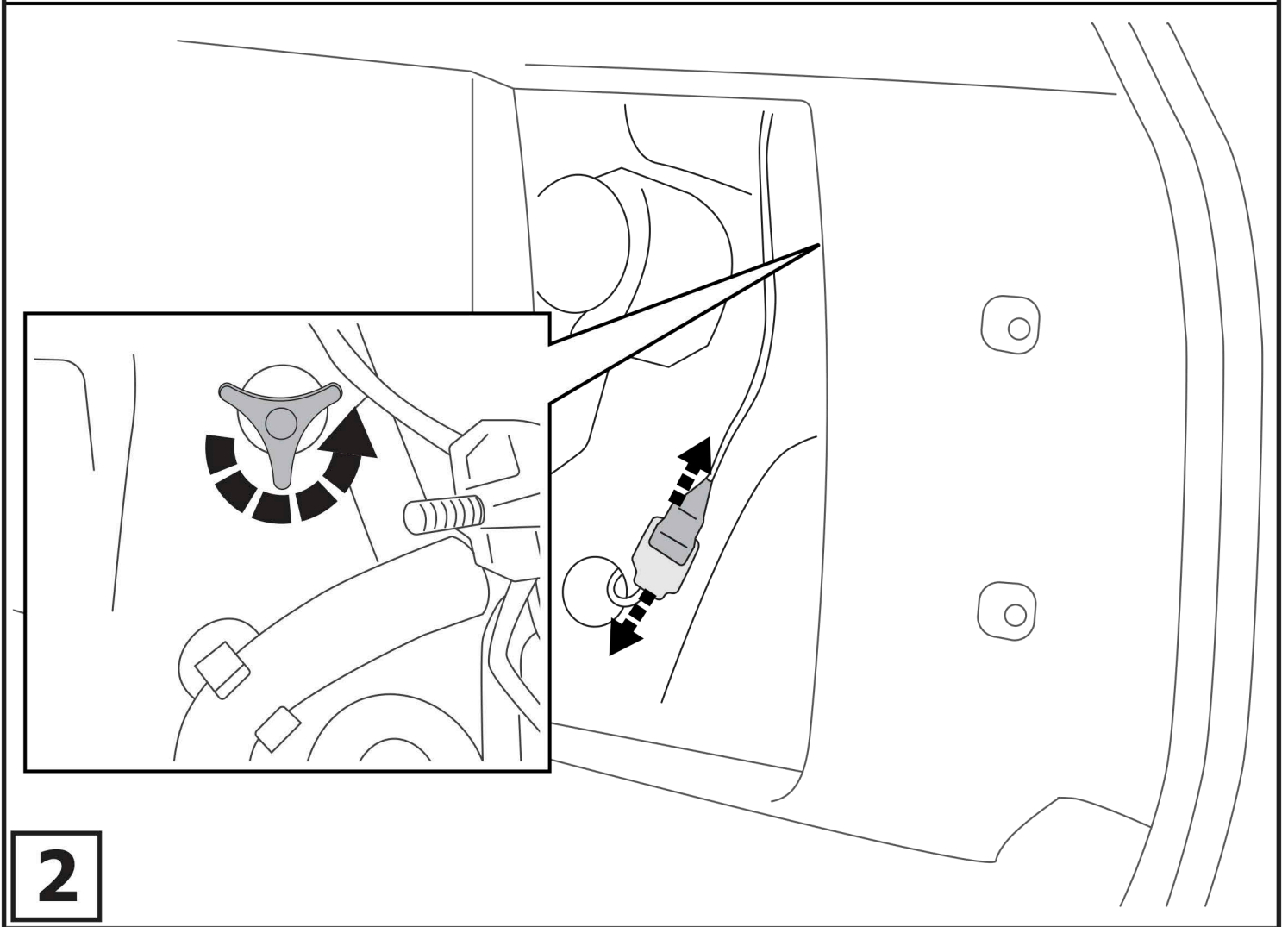
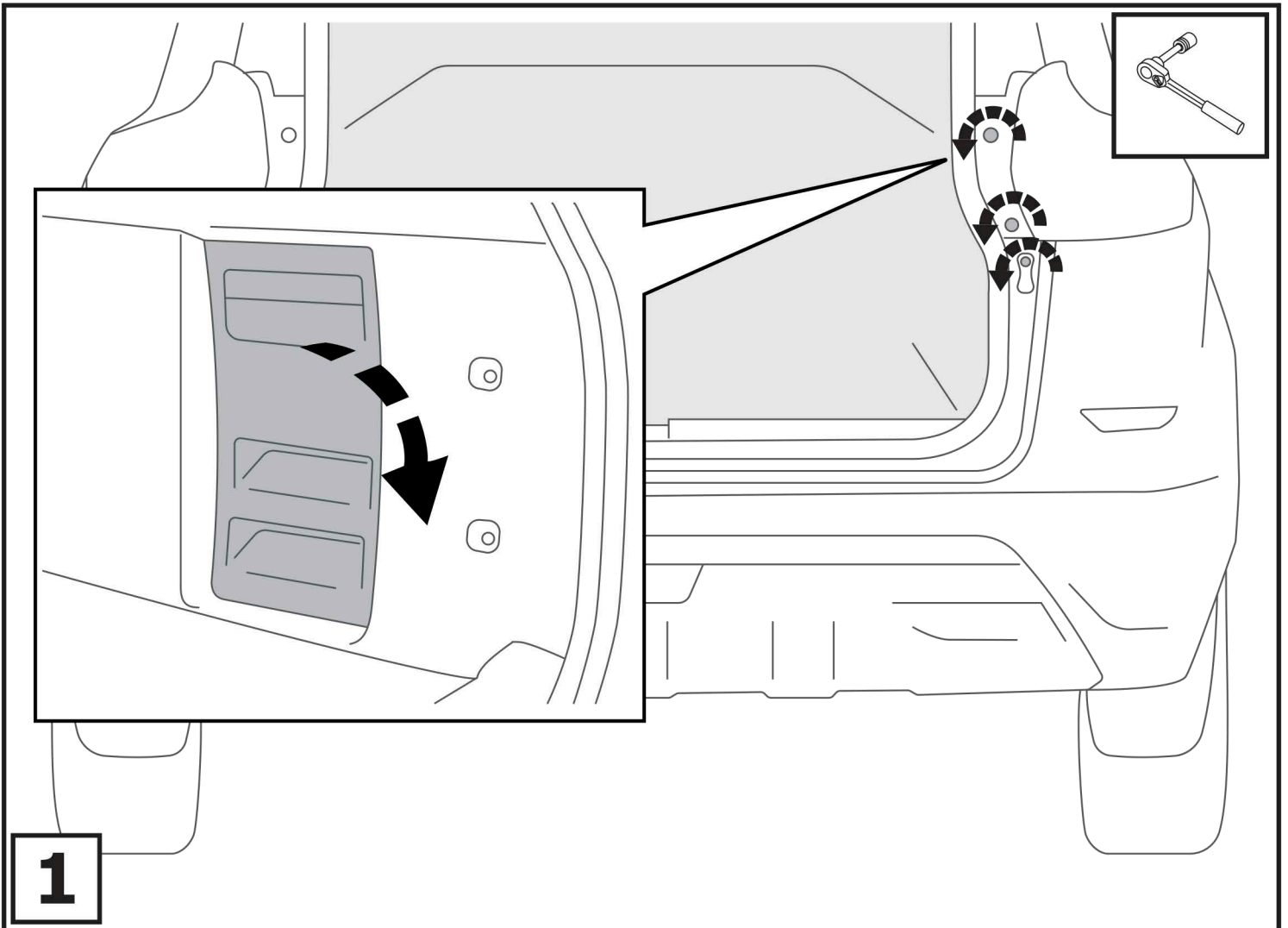

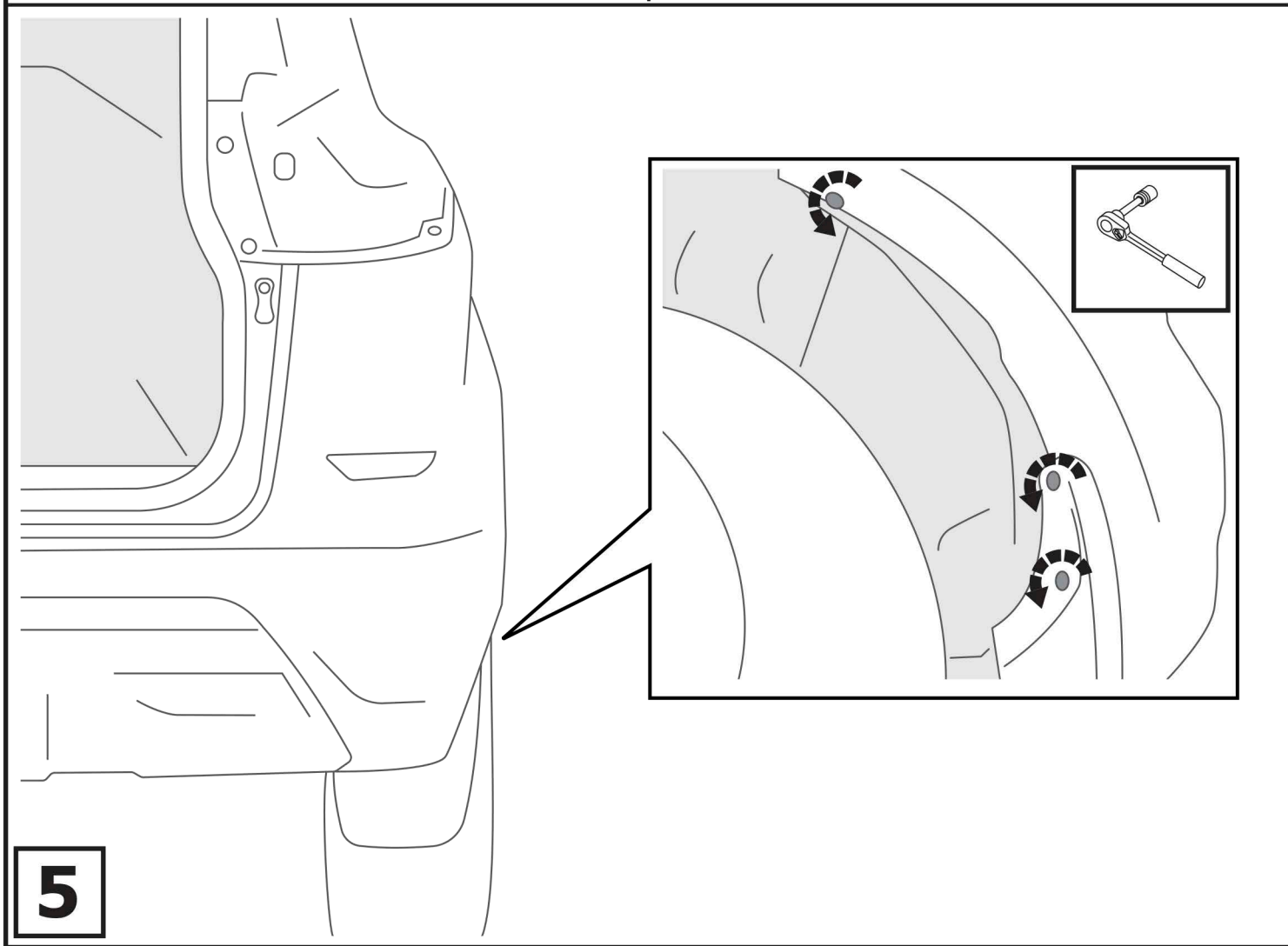
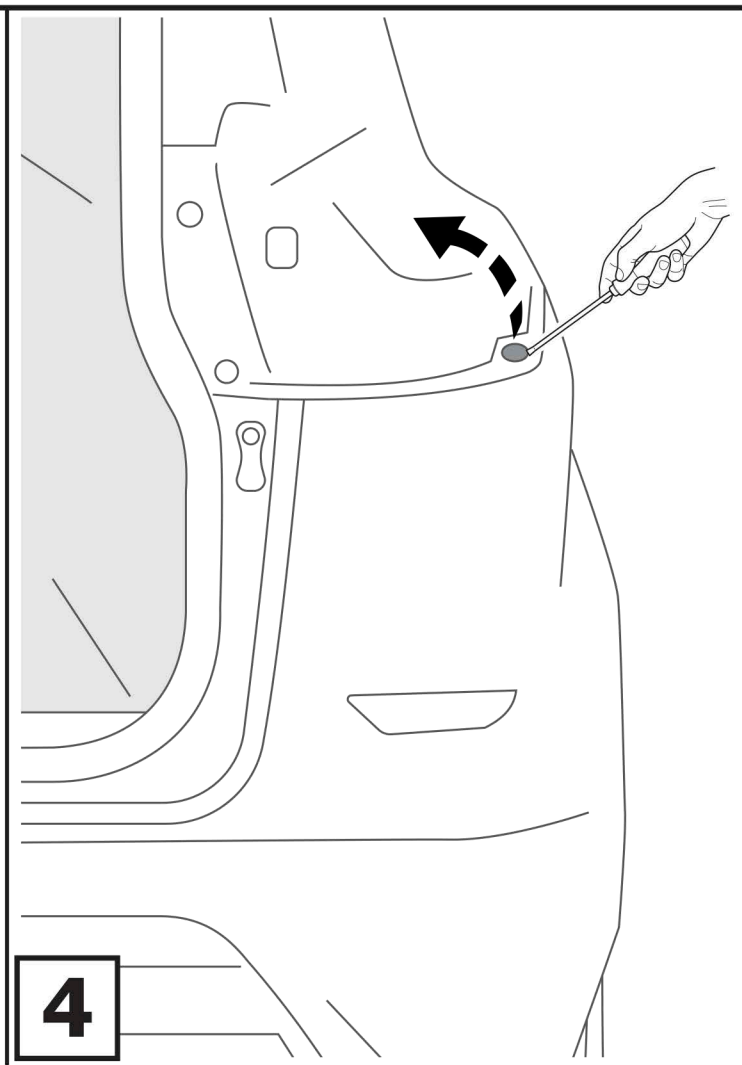
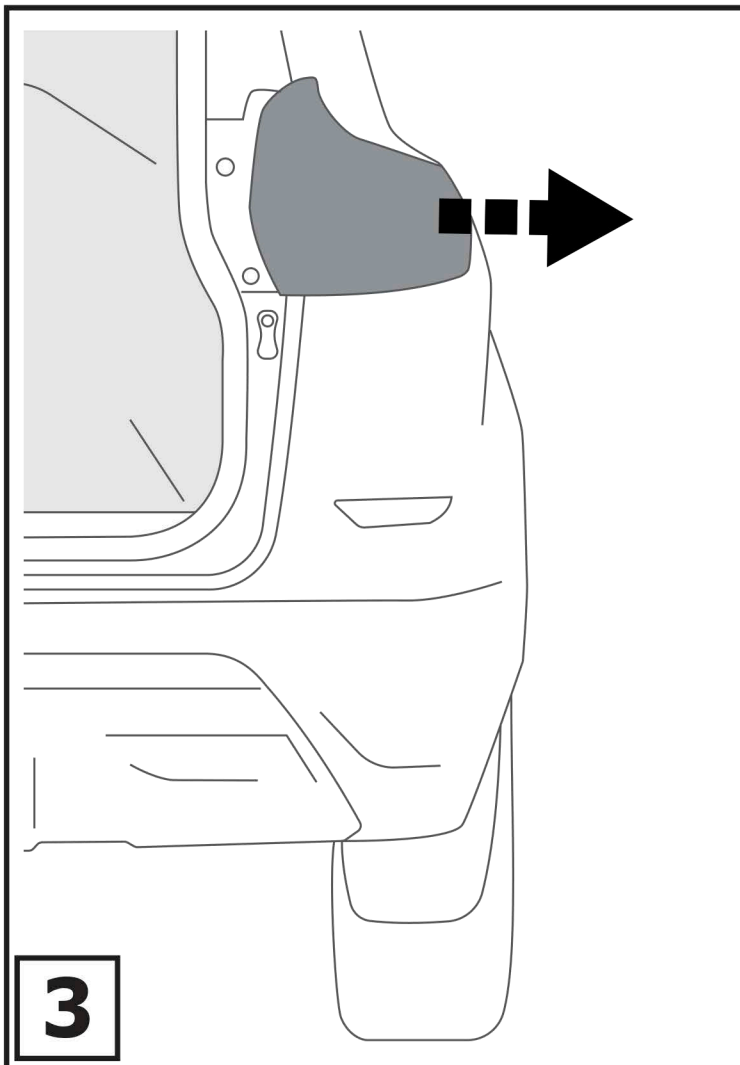

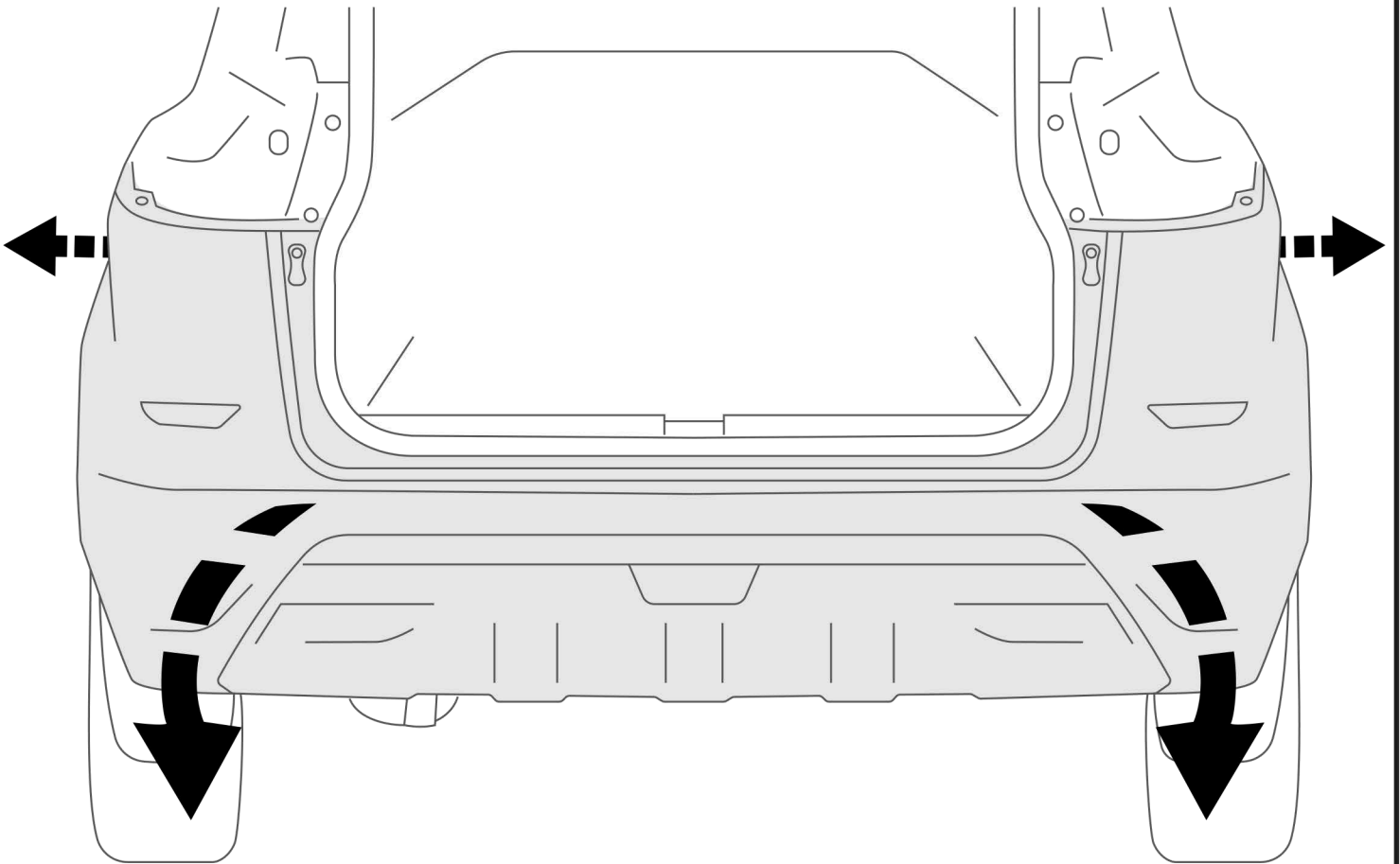
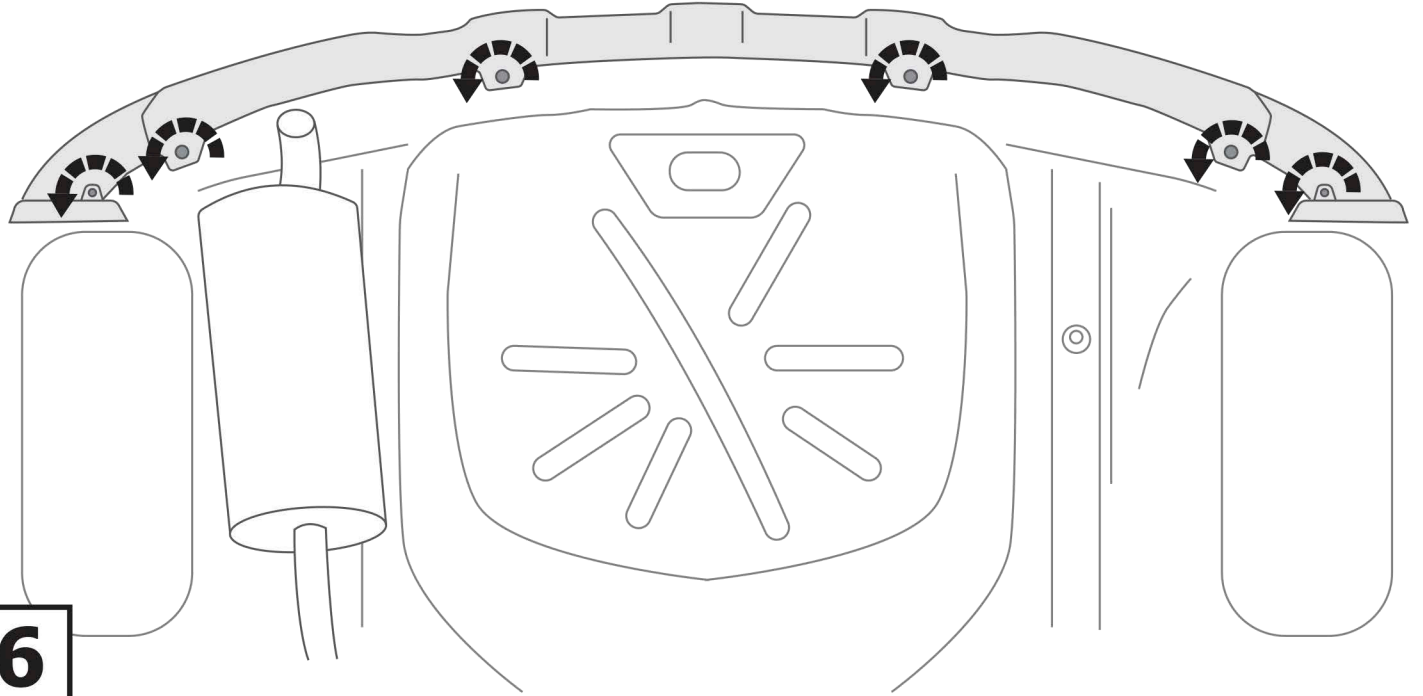
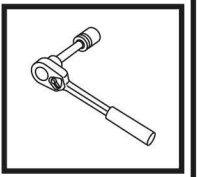
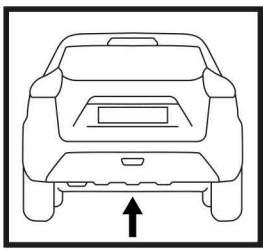

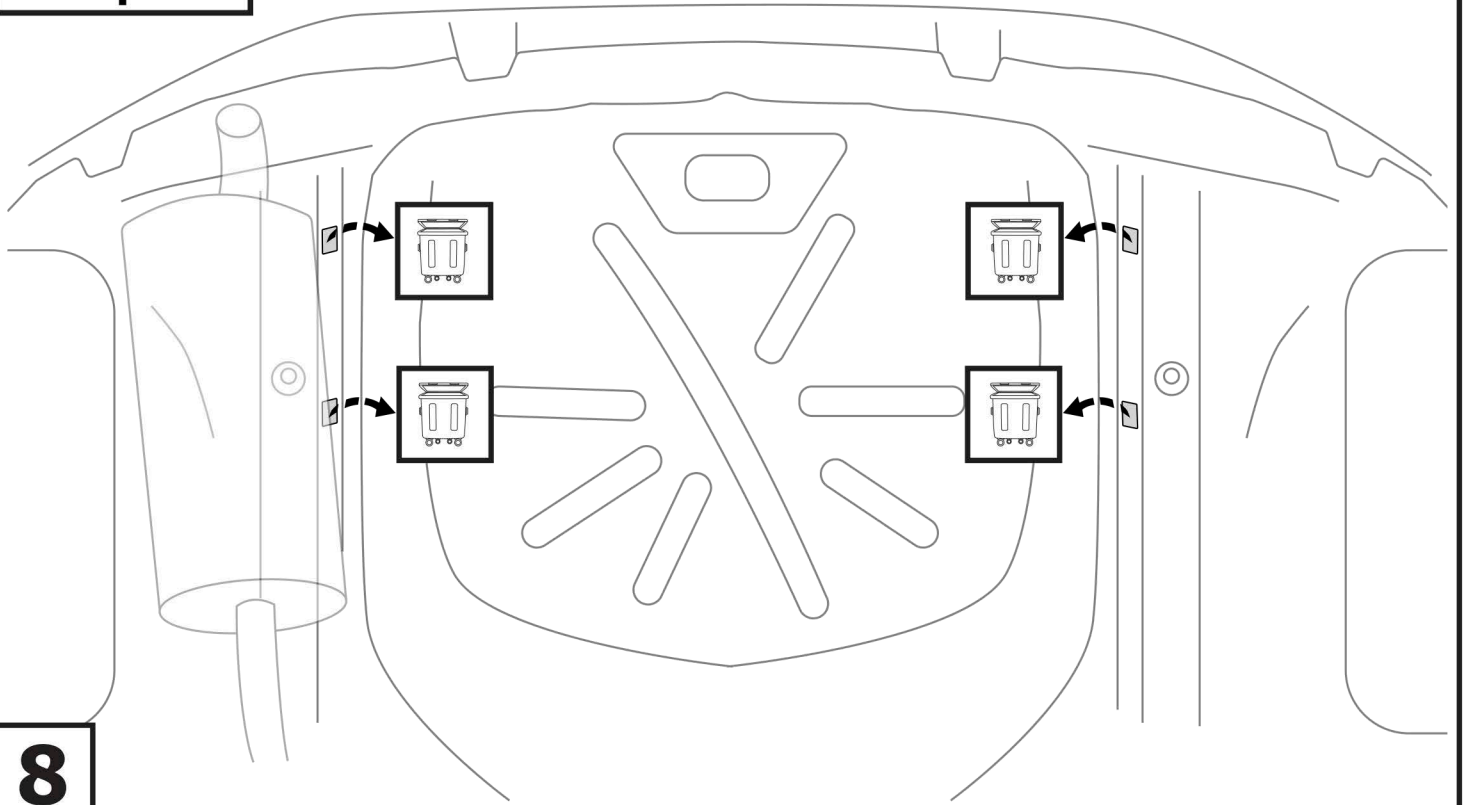
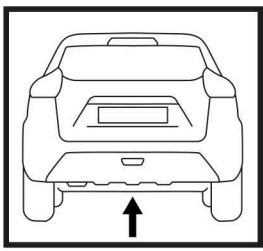

**8**

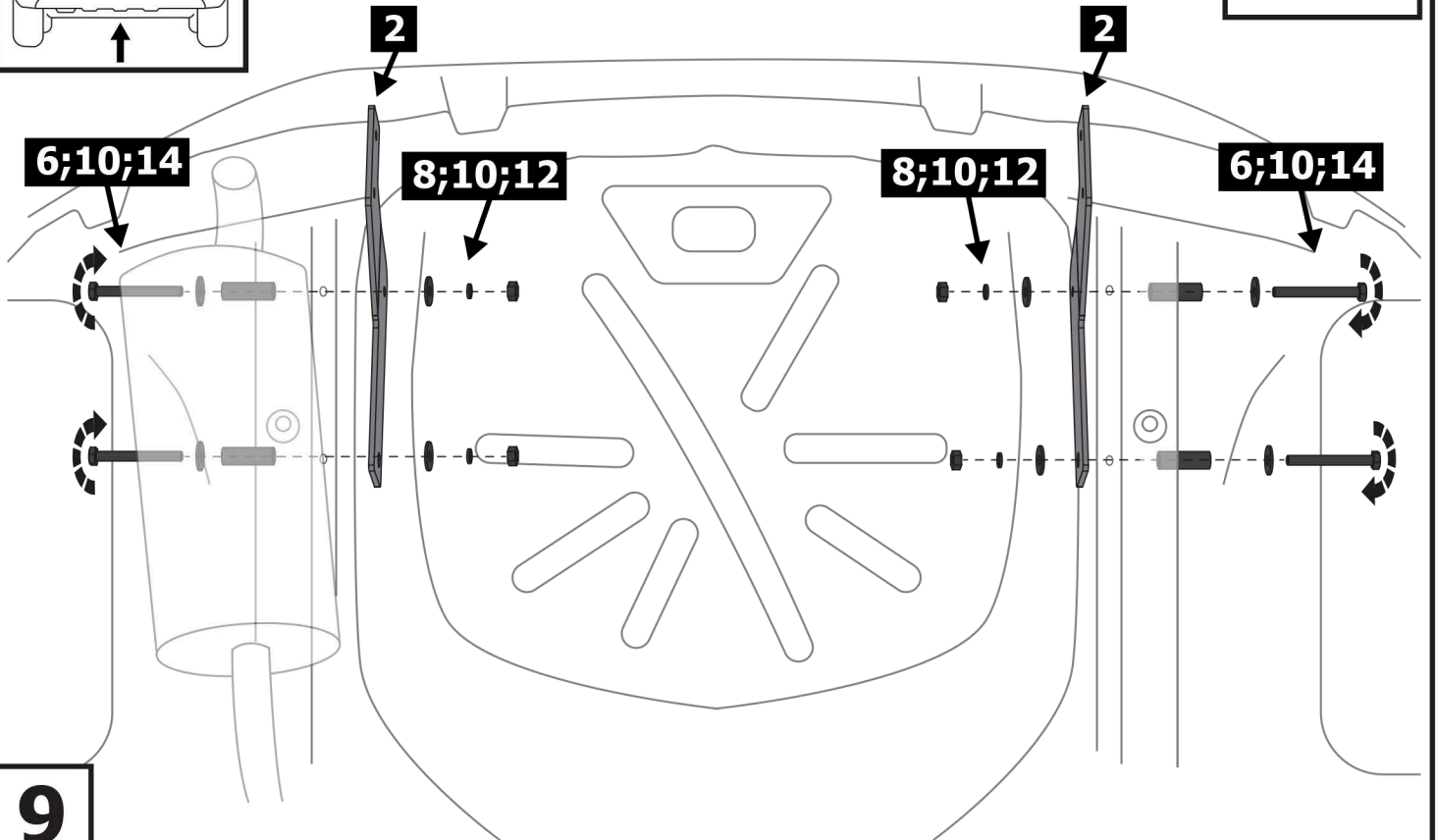
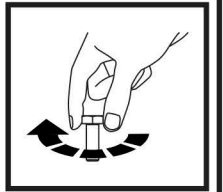
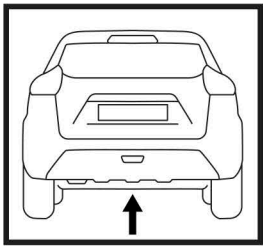

**9**

