

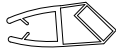











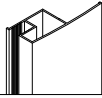



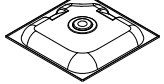



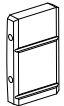

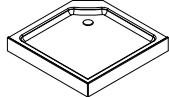
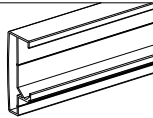



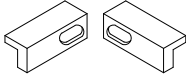
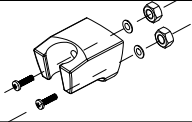

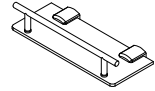
A		8	I		2	Q		4
B	 ST4X35	8	J	 ST4X10	8	R	 ST4X8	12
C		2	K		4	S		1
D		2	L	 ST4X10	4	T		1
E		2	M		2	U		1
F		4	N		2	V		1
G		4	O		2	W		2
H		2	P		2	X		2

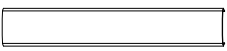
a1		1	f1		2	k1		1
b1		1	g1		1	l1		1
c1		1	h1	 ST4X12	28	m1		1
d1		1	i1		1			
e1		1	j1		2			

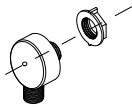

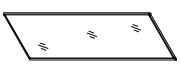
Ø6, Ø2.8

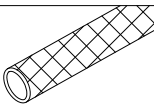
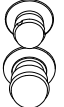
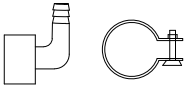
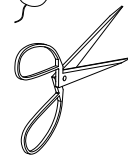
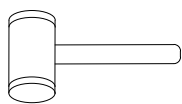
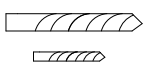
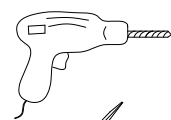
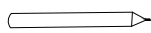
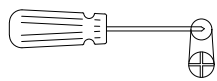
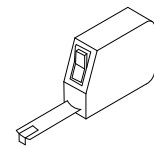
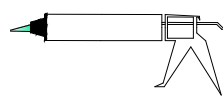
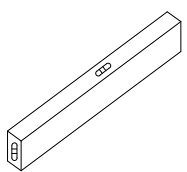
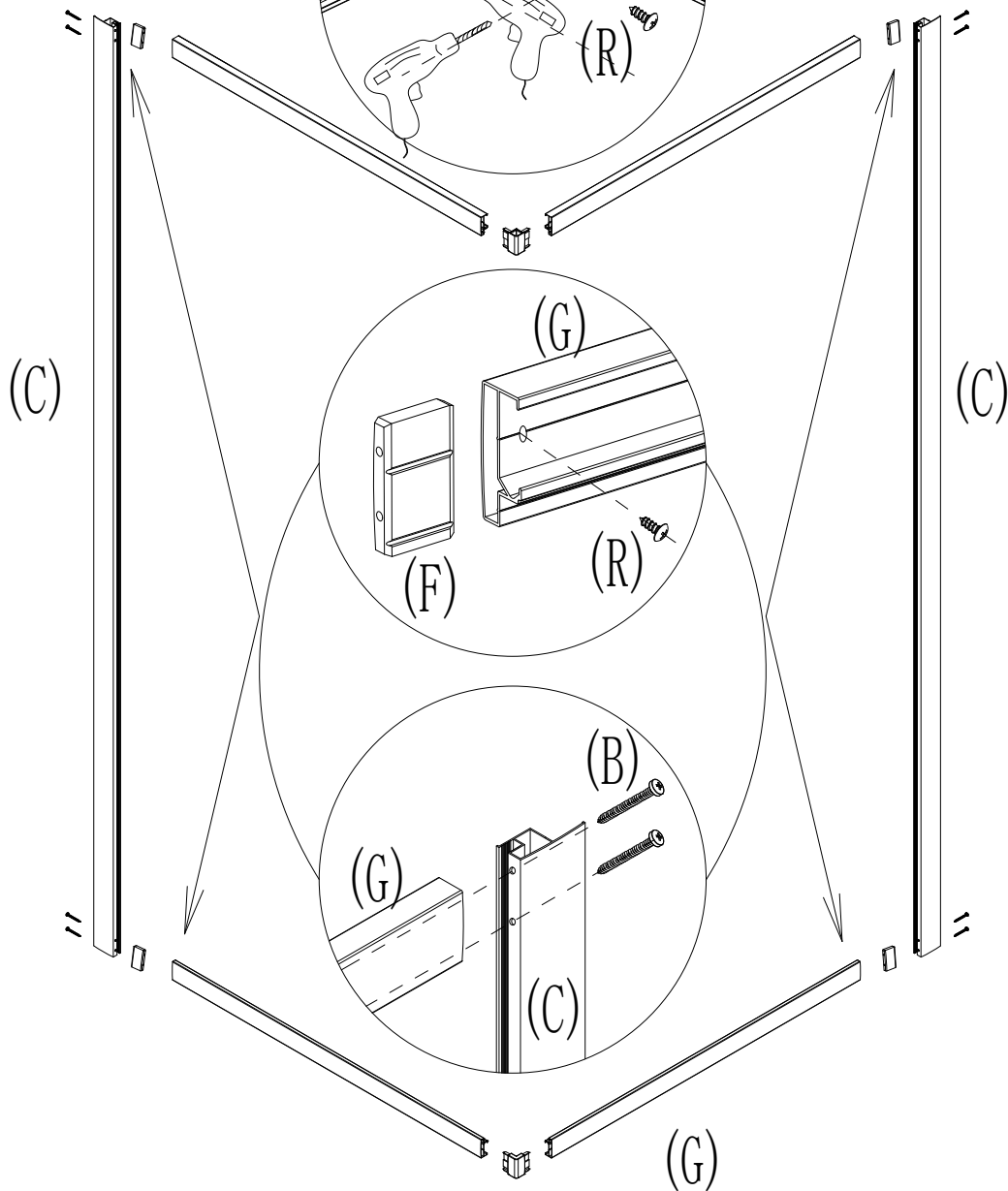
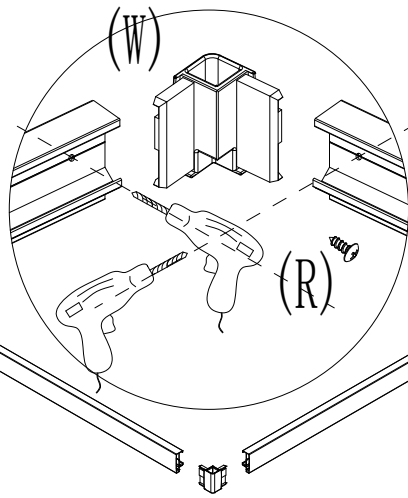
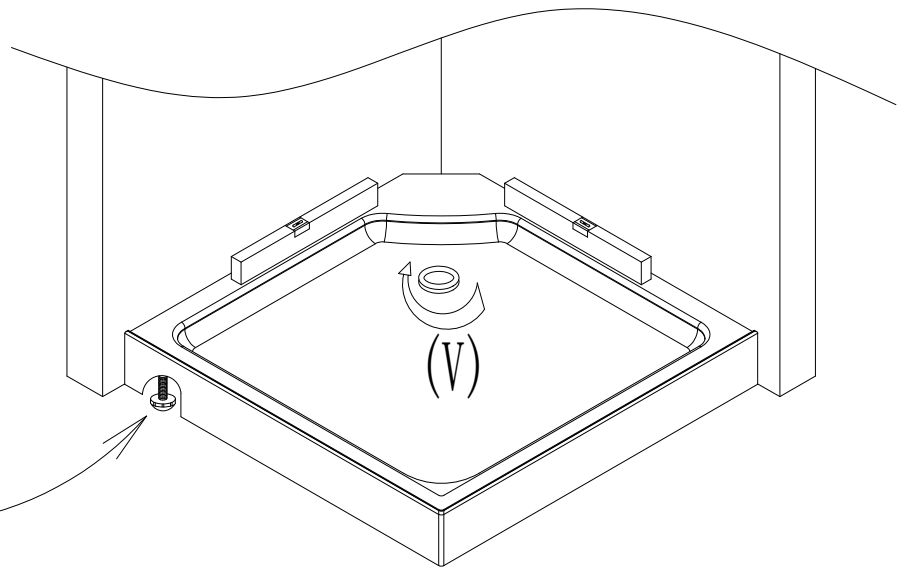
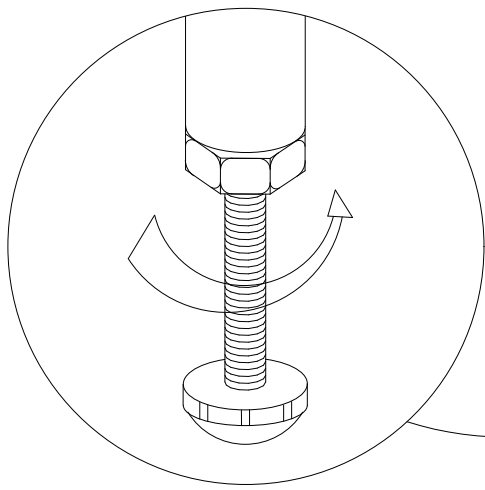

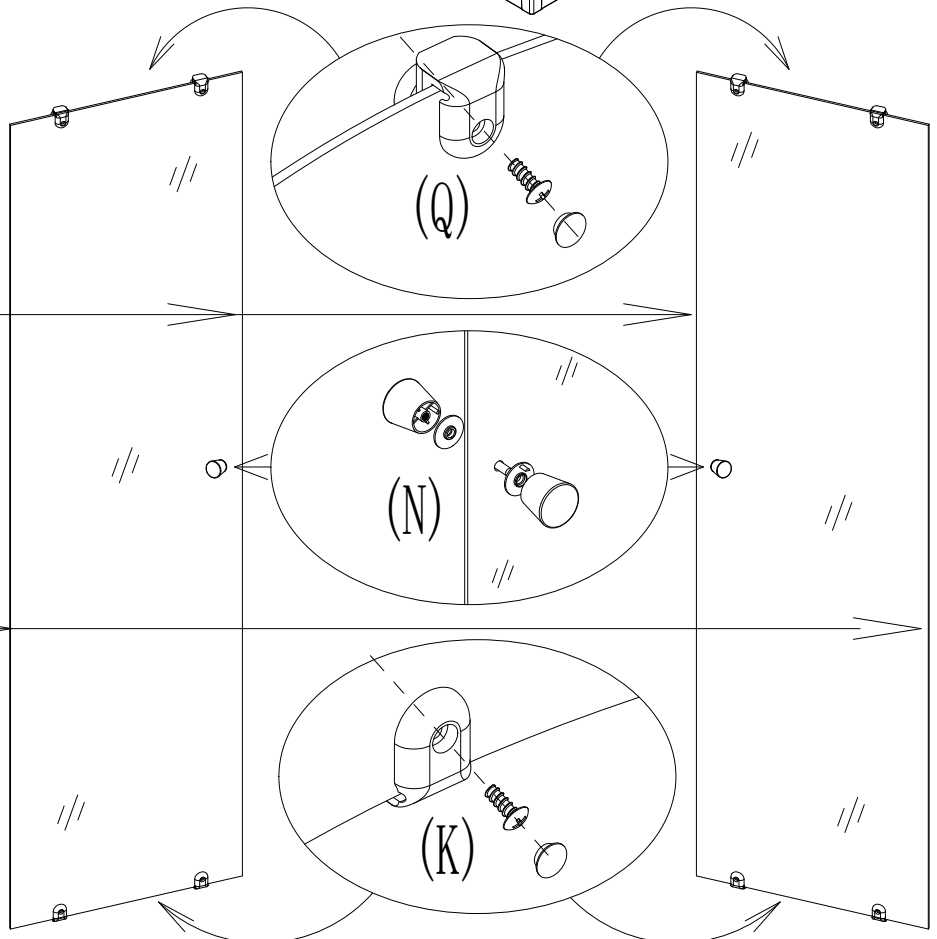
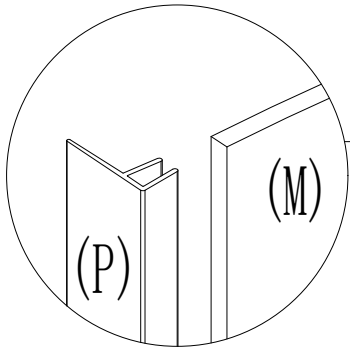
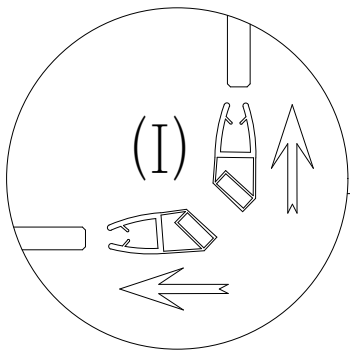
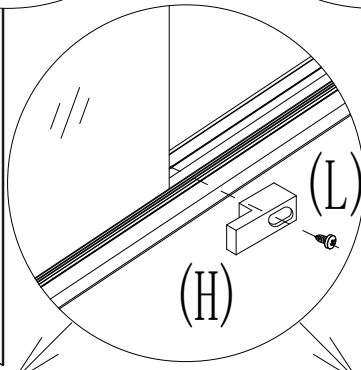
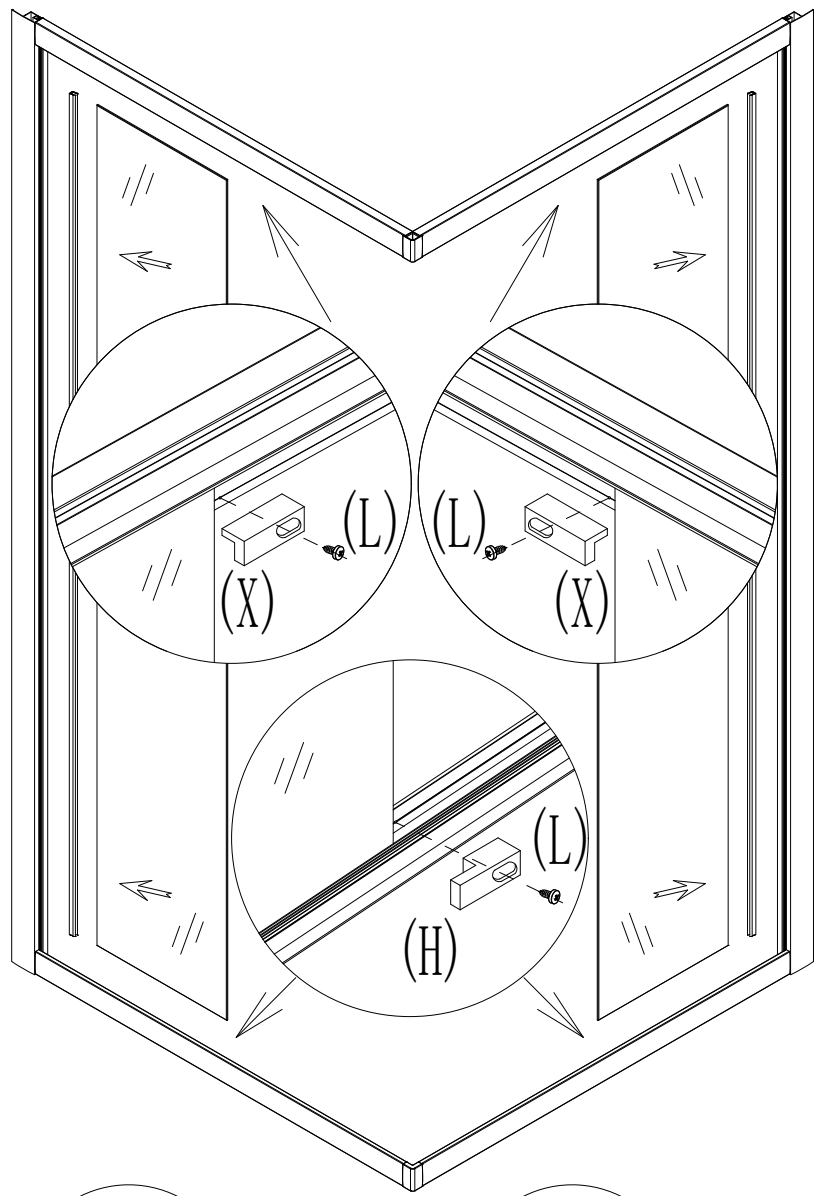
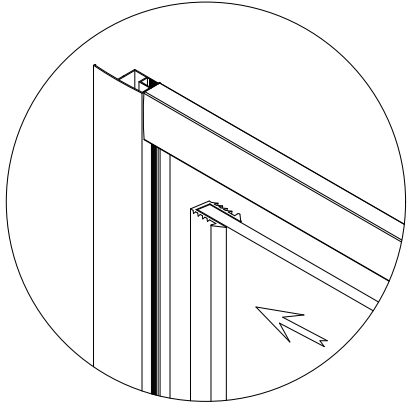
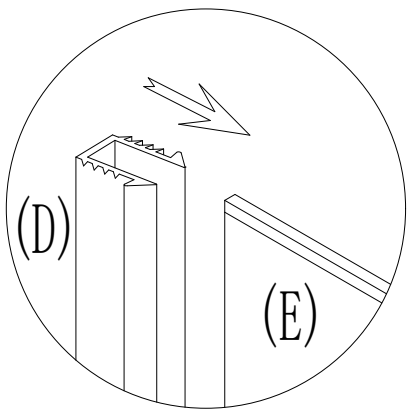

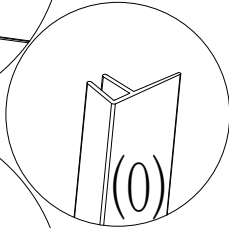
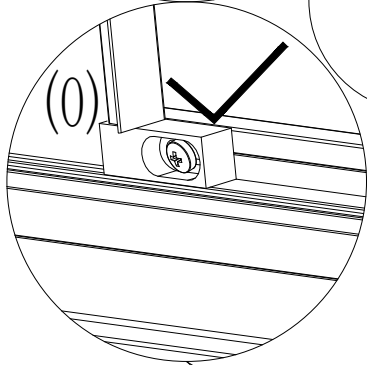
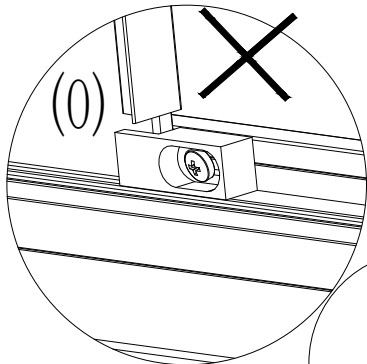

!

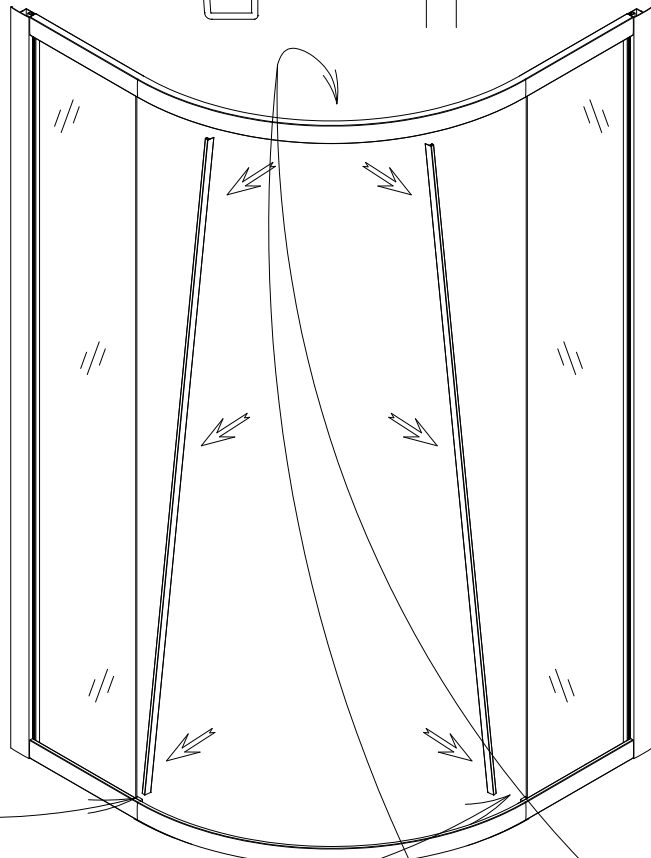

(G)

(Q)

