

# ODDA

711-18-1024  
711-196-1029

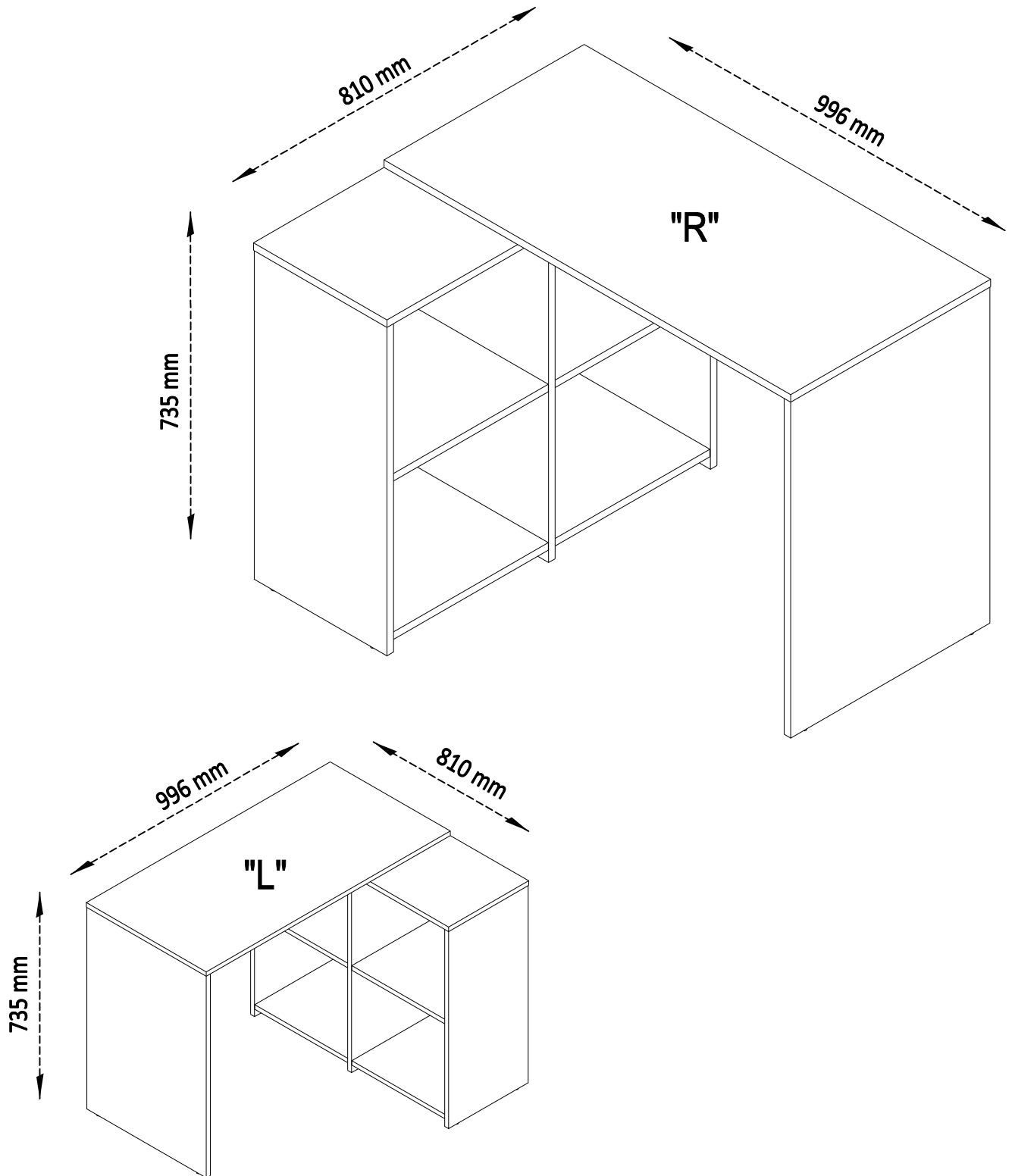

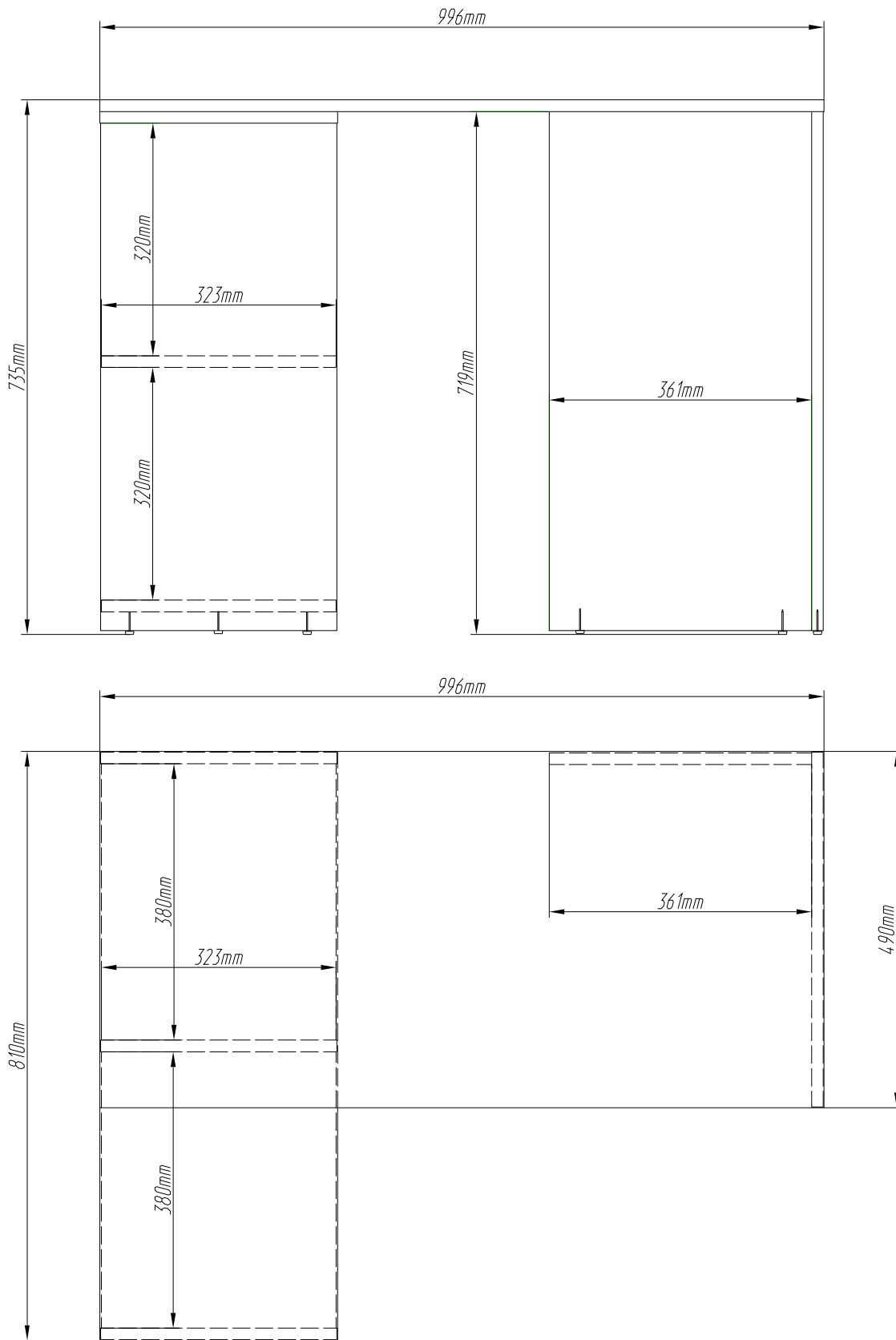
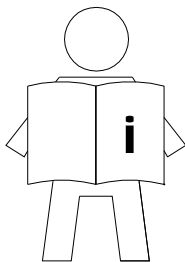

**EN: IMPORTANT INFORMATION!**

Please read the entire manual carefully before starting to assemble and/or using this product. Follow the manual thoroughly and keep it for further reference.

**LV: SVARĪGA INFORMĀCIJA!**

Pirms šī izstrādājuma montāžas un/val lietošanas uzsākšanas pilnībā izlasiet lietošanas pamācību. Stingri ievērojiet pamācības norādījumus un saglabājiet to turpmākai lietošanai.

**LT: SVARBI INFORMACIJA!**

Prieš pradėdami montuoti gaminį ir (arba) juo naudotis, prašome atidžiai perskaityti visą vadovą. Atidžiai skaitykite vadovą ir turėkite jį su savimi, kad galėtumėte toliau vadovautis jo nuorodomis.

**EE: OLULINE TEAVE!**

Enne kui alustate toote kokku panemist ja/või kasutamist, lugege see kasutusjuhend hoolikalt läbi. Järgige täpselt juhendis toodud juhiseid ja hoidke juhend alles.

**BY(RU): ВАЖНАЯ ИНФОРМАЦИЯ!**

Внимательно и полностью прочитайте это руководство, прежде чем приступать к сборке или использованию этого изделия. Следуйте всем инструкциям этого руководства и сохраните его на будущее для справки.

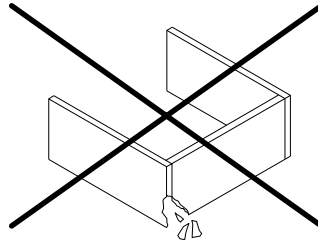
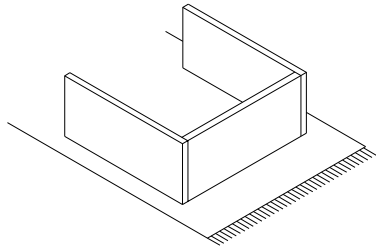

**EN: WARNING TO AVOID SCRATCHES!**

In order to avoid scratching this furniture should be assembled on a soft layer - could be rug.

**LV: BRĪDINĀJUMS PAR SKRĀPĒJUMIEM!**

Lai nesaskrāpētu šo izstrādājumu, veiciet montāžu uz mīkstas pamatnes, piemēram, paklāja.

**LT: ĮSPĖJIMAS, KAD IŠVENGTUMĖTE ĮBRĖŽIMŲ!**

Šio baldo nesubraižysite, jei jį surinksite ant švelnaus paviršiaus, pavyzdžiui, kilimo.

**EE: HOIATUS KRIIMUSTUSTE VÄLTIMISEKS!**

Kriimustuste tekkimise vältimiseks mööblile tuleb see kokku panna pehmel pinnal, nt kaltsuvaibal.

**BY(RU): ПРЕДУПРЕЖДЕНИЕ ОТНОСИТЕЛЬНО ЦАРАПИН!**

Во избежании нанесения царапин, сборку мебели необходимо выполнять на мягкой поверхности, например на ковре.

**EN: IMPORTANT!**

It is important that any product which is assembled using any kind of screw is retightened 2 weeks after assembly, and once every 3 months - in order to assure stability through-out the lifespan of the product.

**LV: SVARĪGI!**

Ir svarīgi, lai jebkuram produktam, kas tiek uzstādīts ar jebkādu skrūvju palīdzību, skrūves tiktu atkārtoti pievilktas 2 nedēļas pēc montāžas; pēc tam - reizi 3 mēnešos, tā nodrošinot stabilitāti visā izstrādājuma kalpošanas laikā.

**LT: SVARBU!**

Bet kokį varžtais tvirtinamą gaminį 2 savaites po surinkimo bei kas 3 mėnesius reikia papildomai suveržti - taip užtikrinamas naudojamo gaminio stabilumas.

**EE: TÄHTIS!**

Oluline on, et toote kruvisid pingutataks 2 nädalat pärast kokkupanekut ja seejärel iga 3 kuu järel, et tagada stabiilsus kogu toote eluea jooksul.

**BY(RU): ВАЖНО!**

В любом изделии, собранном с использованием винтов любого типа, необходимо через 2 недели после сборки и в дальнейшем каждые 3 месяца подтягивать винты, чтобы обеспечить прочность изделия в течение срока эксплуатации



**EN: GENERAL INSTRUCTION FOR FURNITURE MADE OF WOOD OR WOOD COMPOSITES SUCH AS MELAMINE, LAMINATE OR VENEER SURFACES!**

Wipe clean with a damp cloth. Use only water or a gentle detergent. Wipe dry with a clean cloth.

**LV: VISPĀRĒJI NORĀDĪJUMI MĒBELĒM NO KOKA VAI KOKSNES KOMPOZĪTIEM, PIEMĒRAM, MELAMĪNA, LAMINĀTA VAI FINIERA VIRSMĀM!**

Noslaukiet ar mitru drānu. Lietojiet tikai ūdeni vai maigu mazgāšanas līdzekli. Nosusiniet ar tīru drānu.

**LT: BALDŲ IŠ MEDIENOS AR MEDIENOS KOMPOZITO, DENGTO MELAMINU, LAMINATU AR PLONU FANEROS SLUOKSNIU, BENDRIEJI VALYMO NURODYMAI!**

Valykite drėgnu skudurėliu. Naudokite tik vandenį arba švelnų valiklį. Nusausinkite švariu skudurėliu.

**EE: PUIDUST VÕI MITMEKIHILISEST PUIDUST, NAGU MELAMIINIST, LAMINAADIST VÕI VINEERIST MÖÖBLI ÜLDJUHISED!**

Kasutage puhastamiseks niisket lappi. Kasutage ainult vett või õrnatoimelist puhastusvahendit. Pühkige puhta lapiga kuivaks.

**BY(RU): ОБЩИЕ УКАЗАНИЯ ОТНОСИТЕЛЬНО МЕБЕЛИ, ИЗГОТОВЛЕННОЙ ИЗ ДЕРЕВА ИЛИ ДРЕВЕСНЫХ КОМПОЗИЦИОННЫХ МАТЕРИАЛОВ, ТАКИХ КАК МЕЛАМИН, ЛАМИНАТ ИЛИ ШПОН!**

Очистите изделие чистой влажной тканью. Используйте мягкодействующее моющее средство. Вытрите досуха чистой тряпкой.

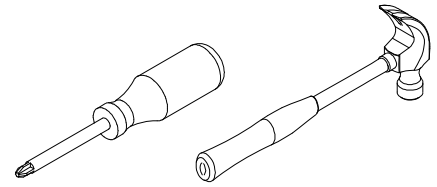
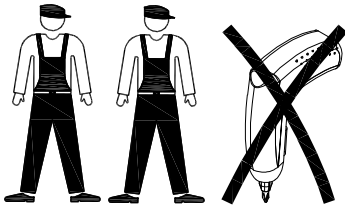

**Ax28**

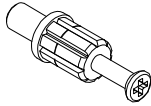

**Ø7x32 mm**

**Bx28**

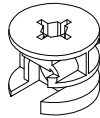

**Ø15x12 mm**

**Cx28**



**20x0,5 mm**

**Dx28**

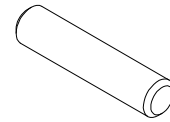

**Ø8x35 mm**

**Ex9**



**Fx2**

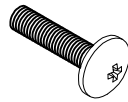

**M6x25**

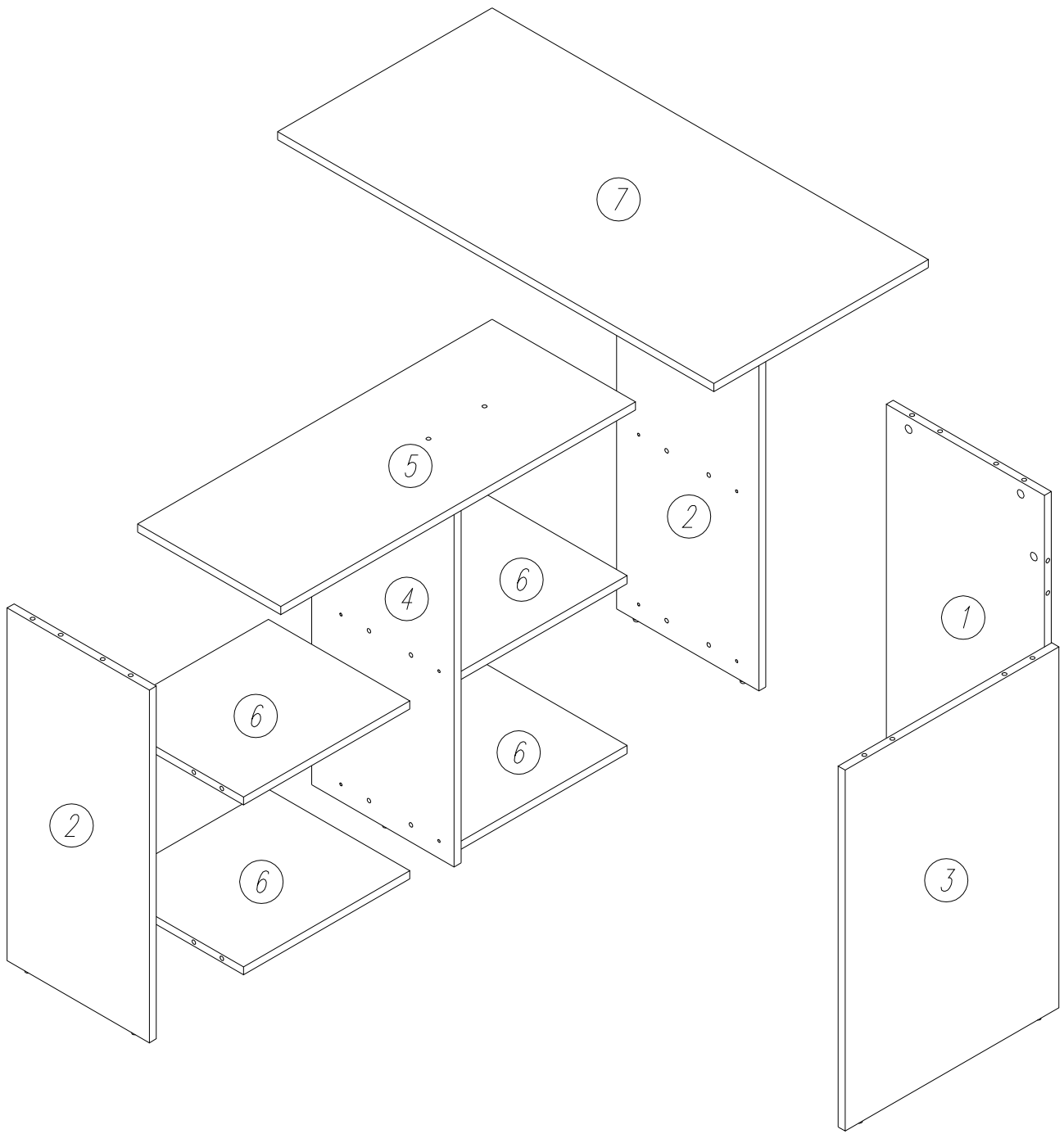



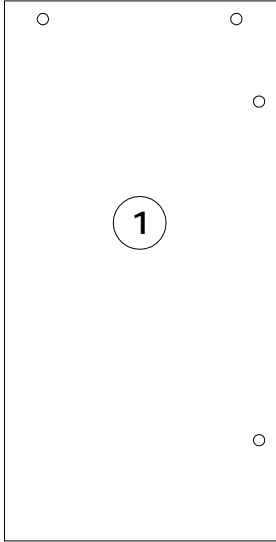

**714x361x16**

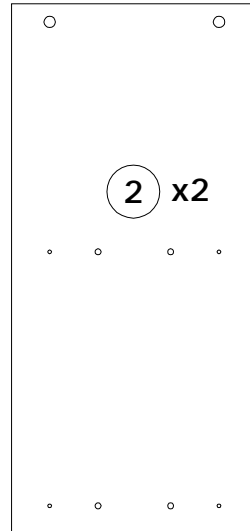

**698x325x16**

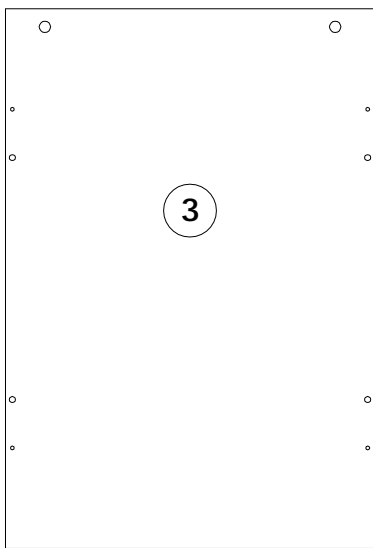

**714x488x16**

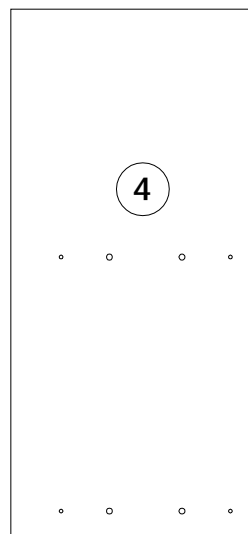

**698x325x16**

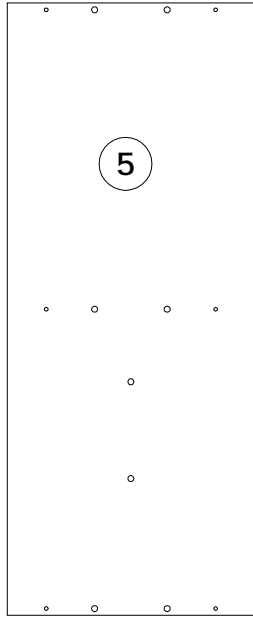

**810x327x16**

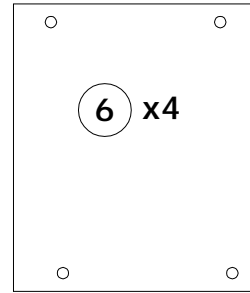

**380x323x16**

1

x2

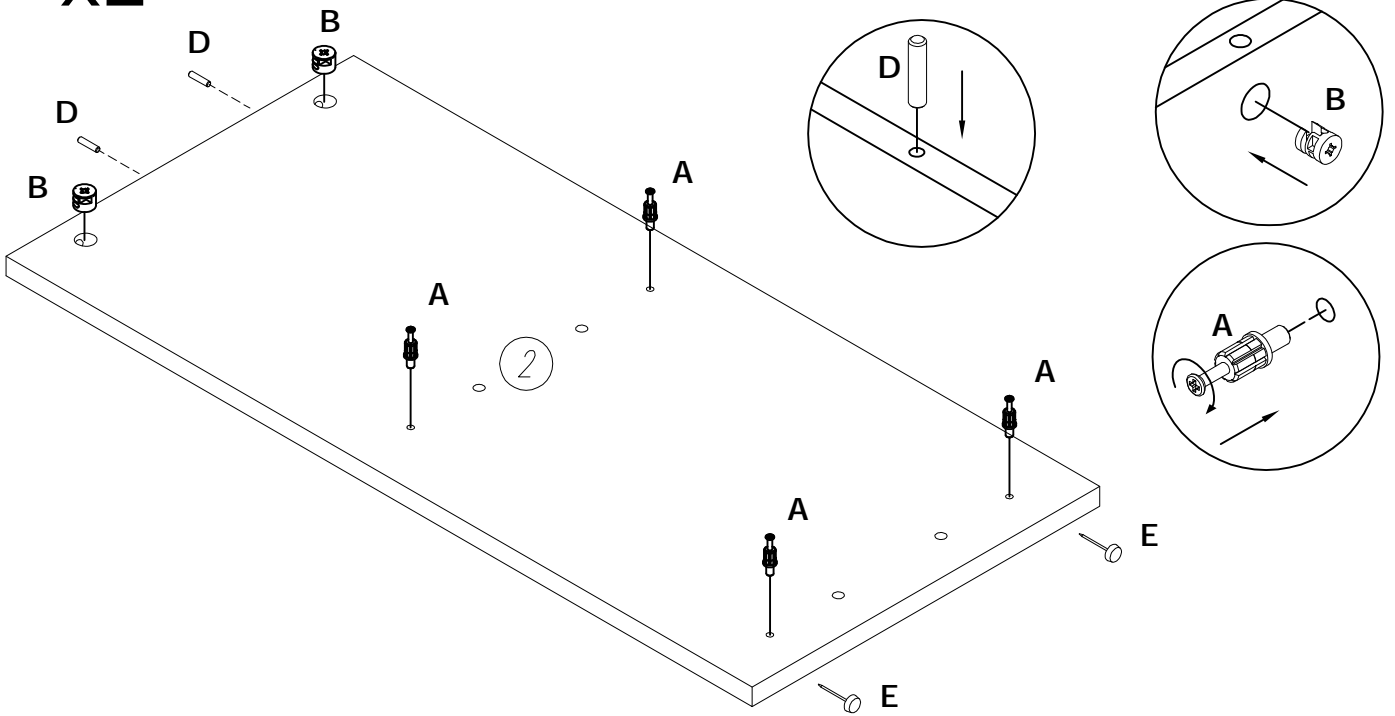
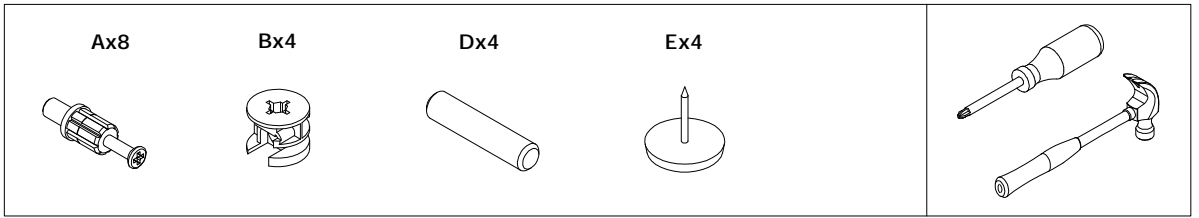

2

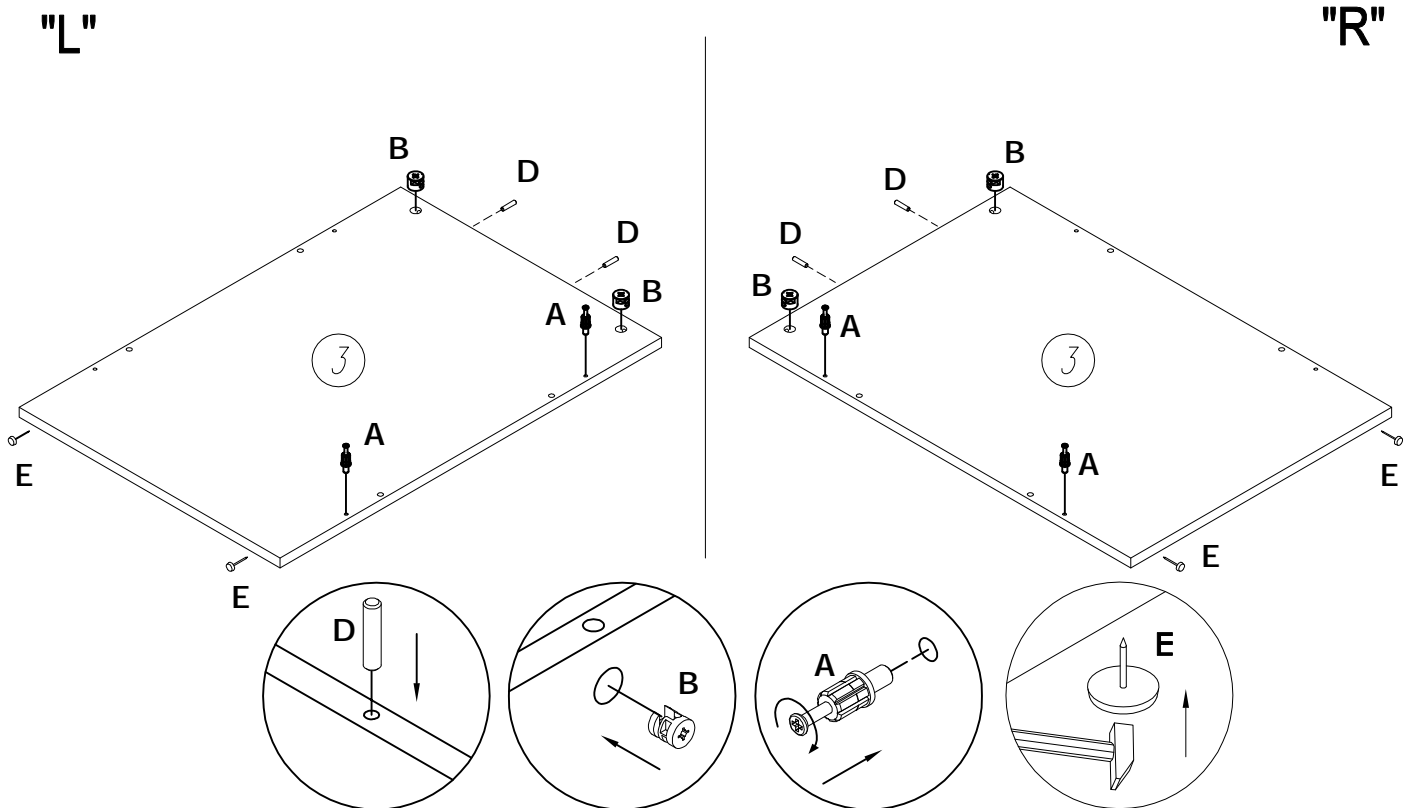
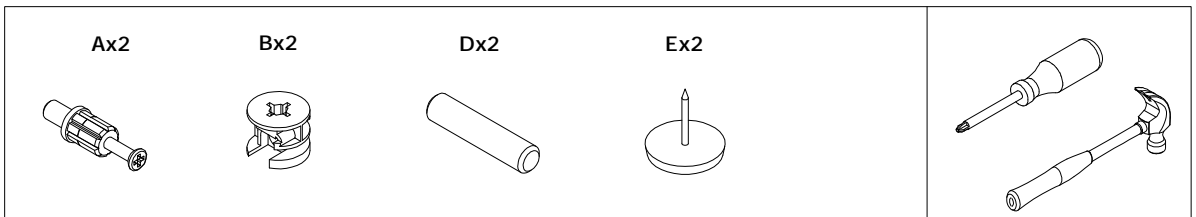

3

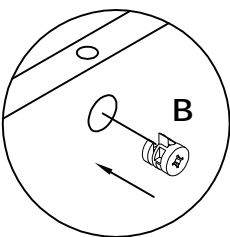
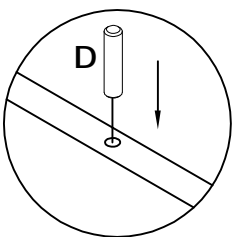
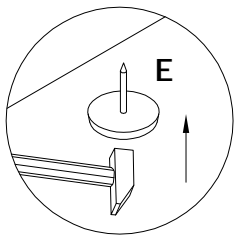
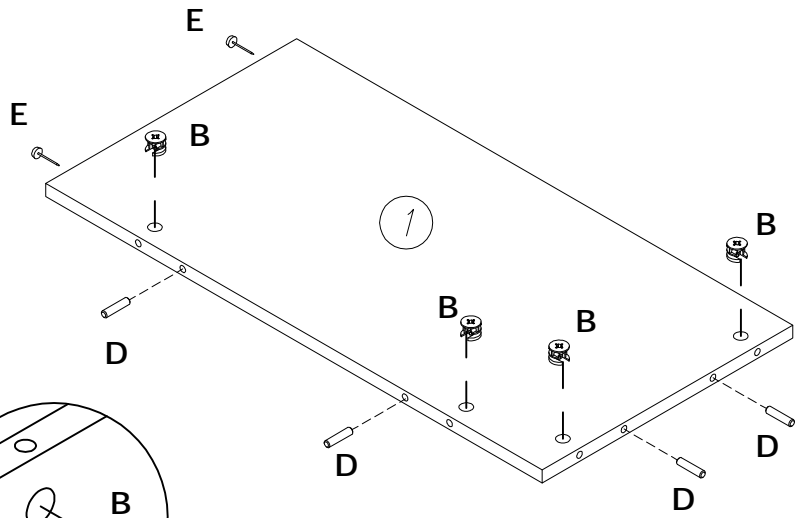
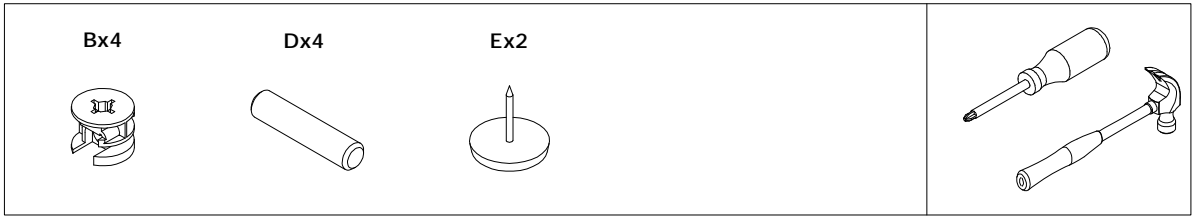

4

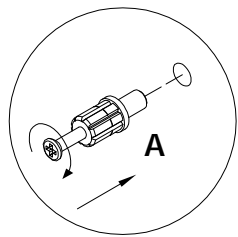
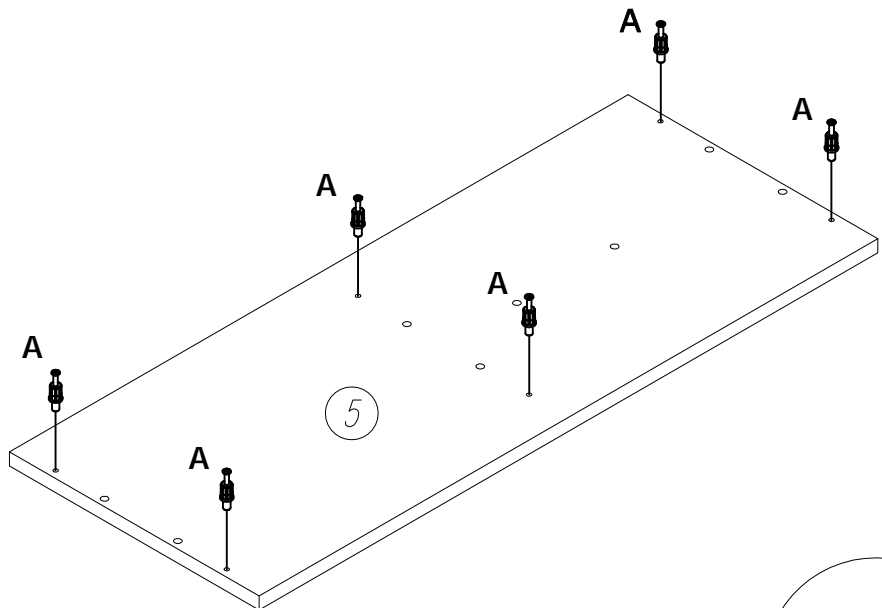
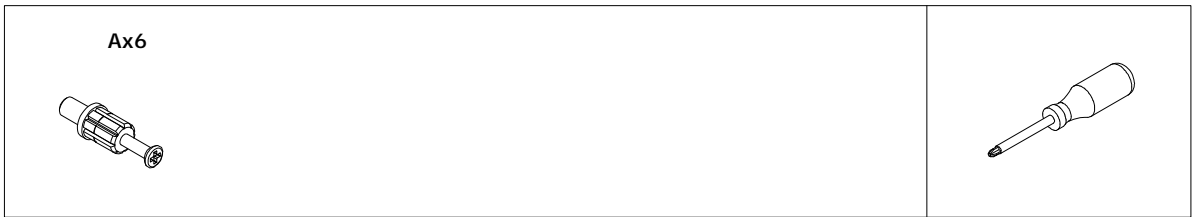

5

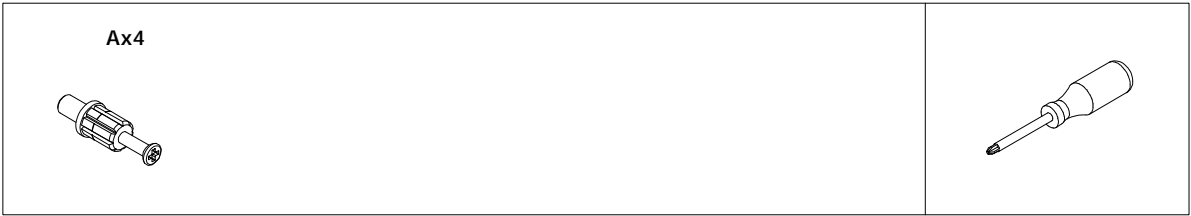

"L"

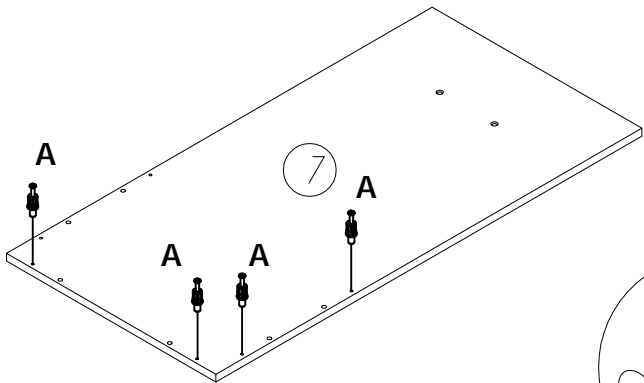

"R"

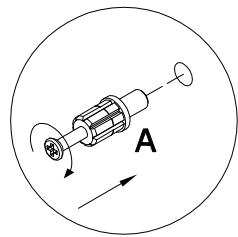
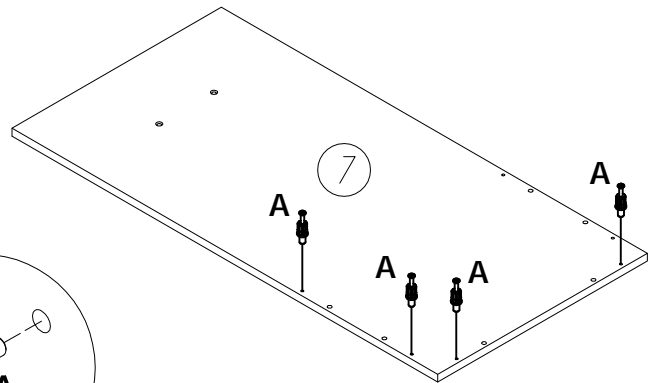

6

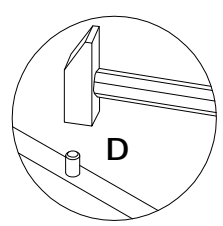
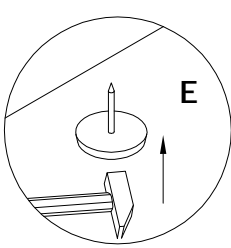
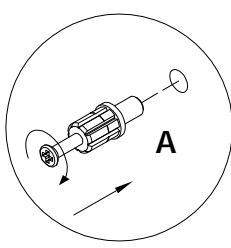
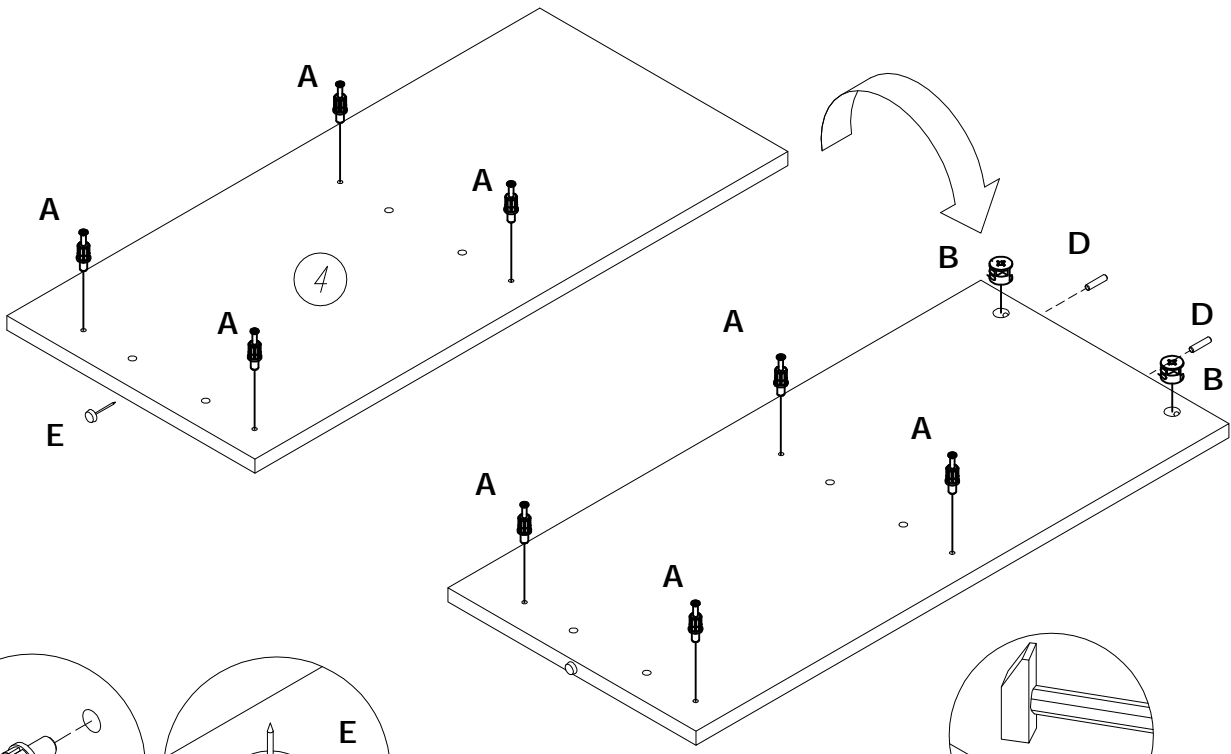
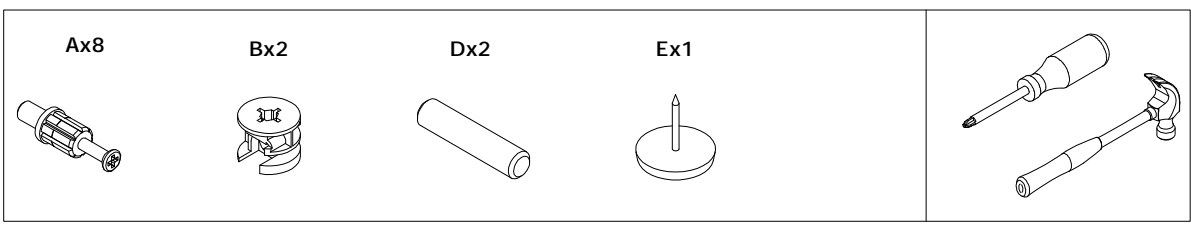

7

x4

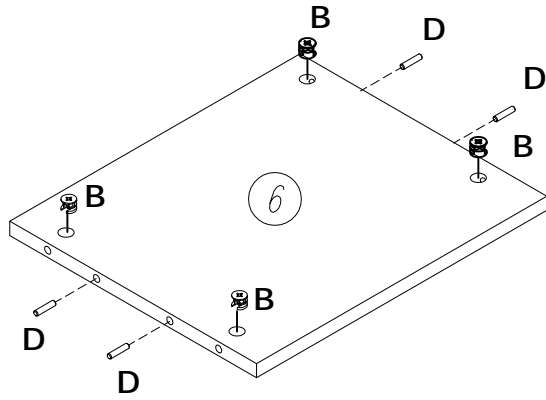
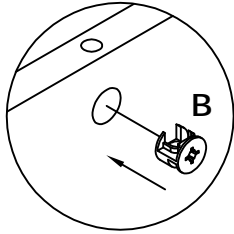
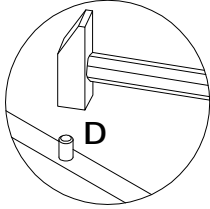
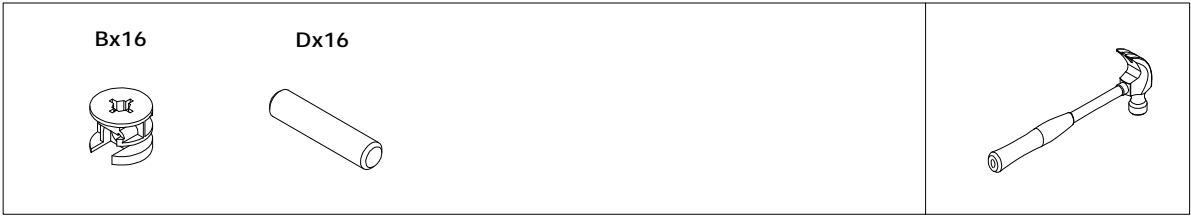

8

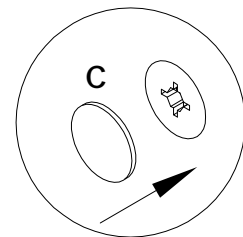
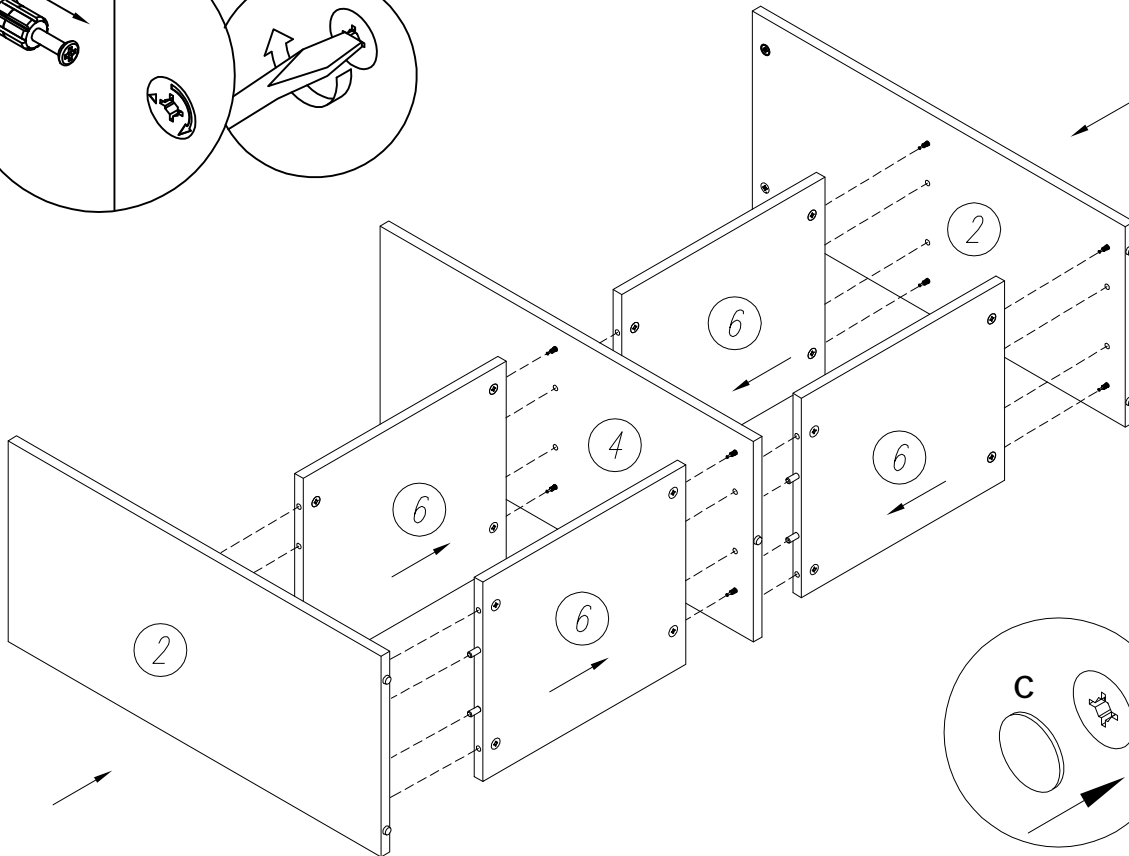
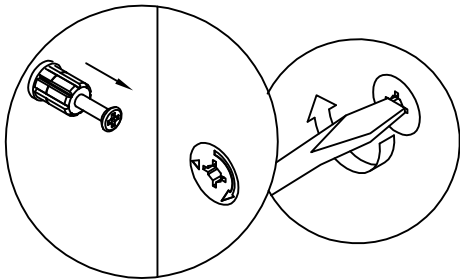
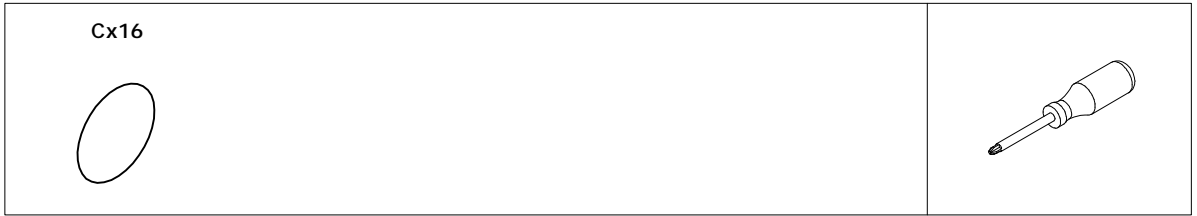

9

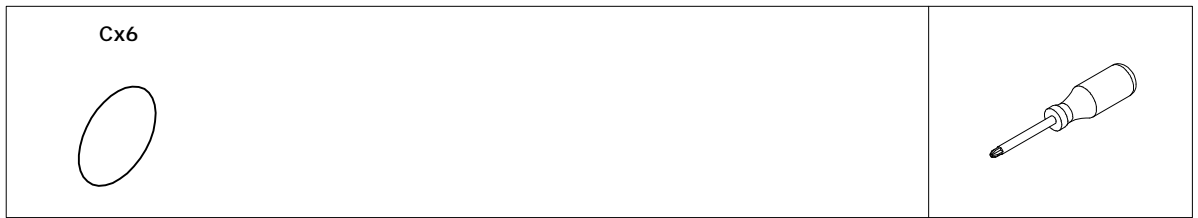

"L"

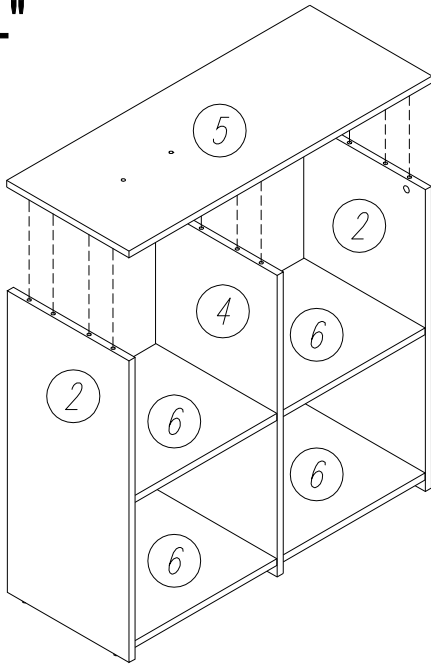

"R"

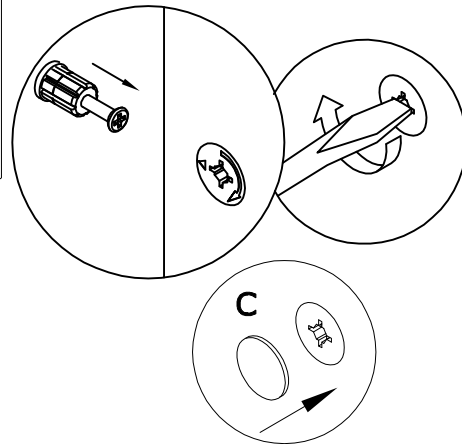
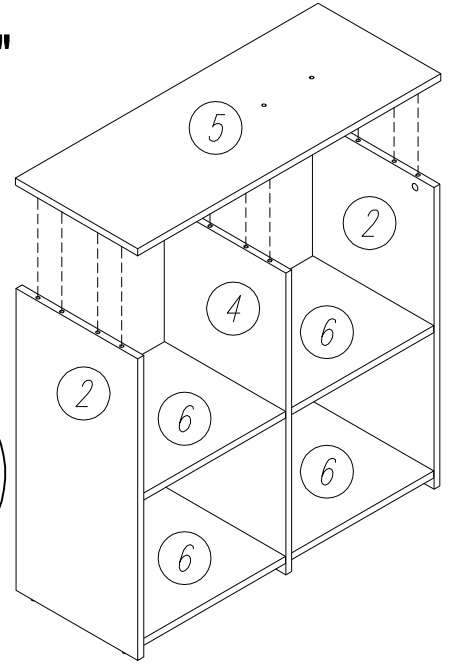

10



"L"

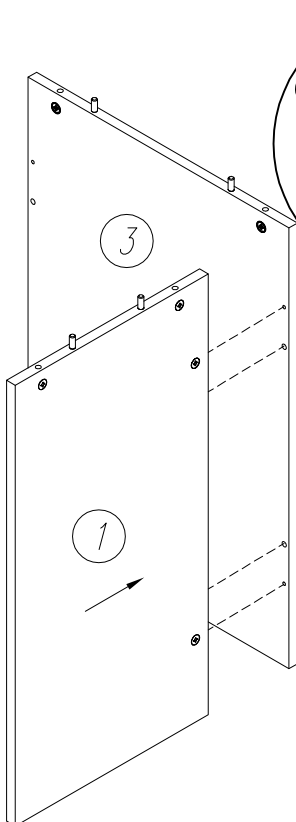

"R"

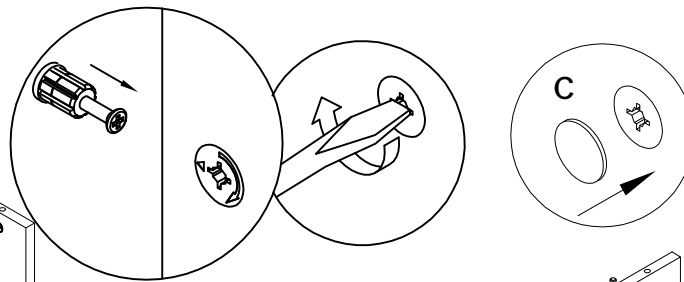
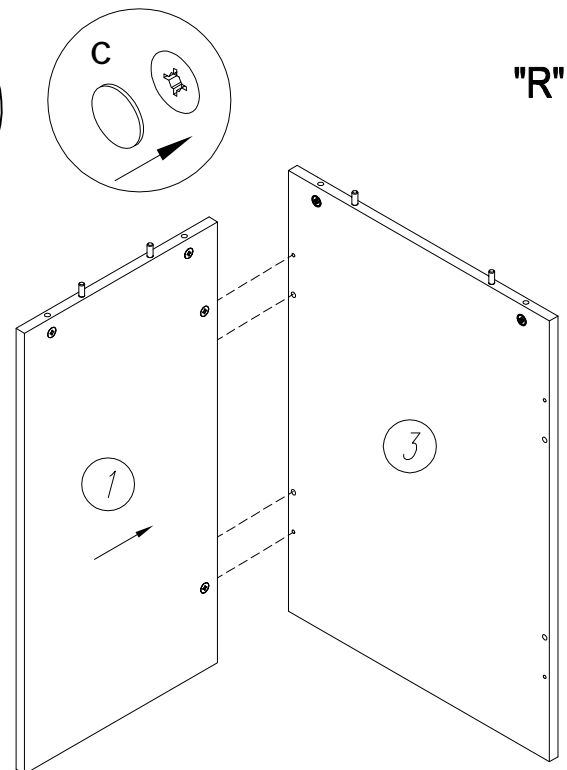

9

Cx4

Fx2

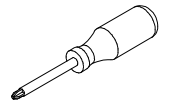
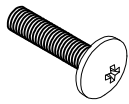

"R"

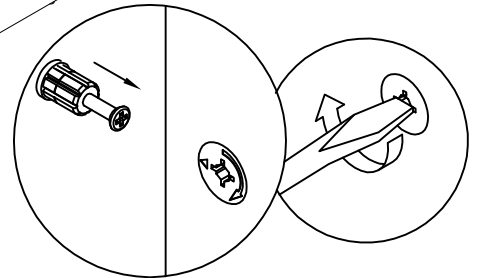
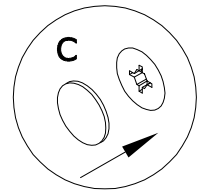
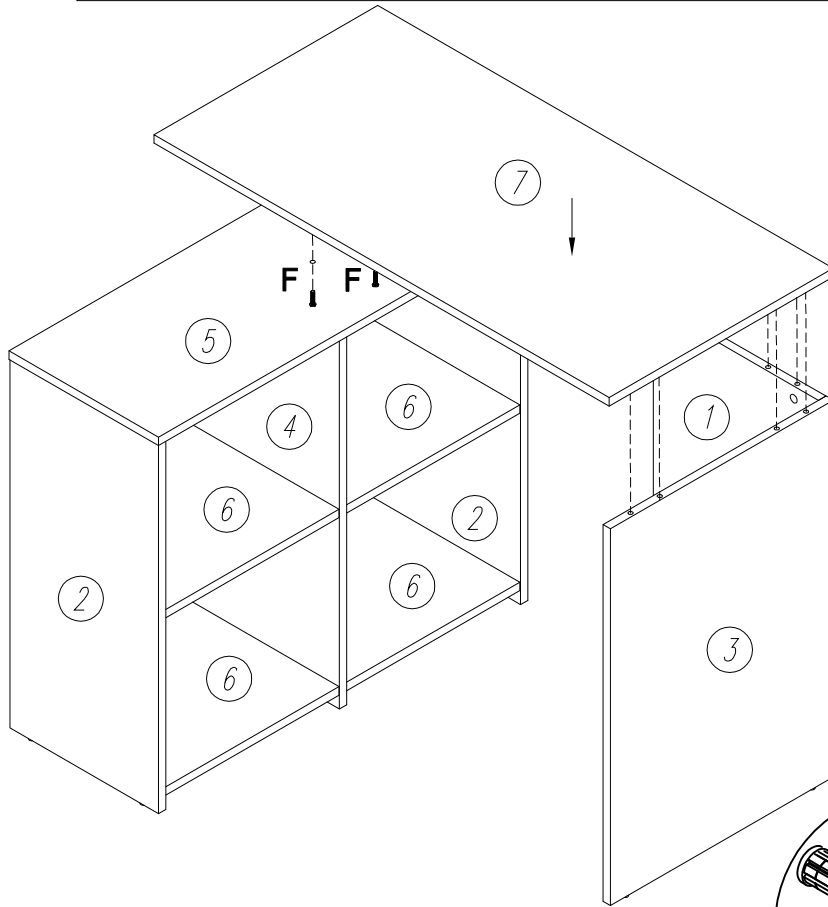

"L"

