



Maggie

Steve



Maggie

Steve

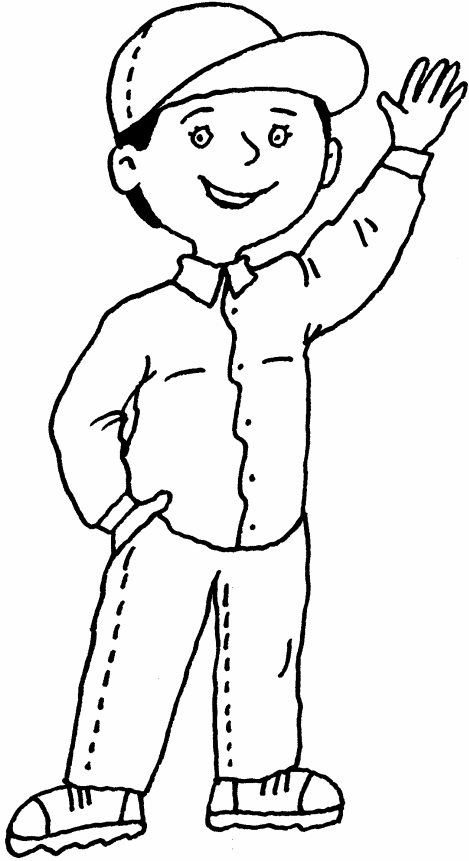

Pavel

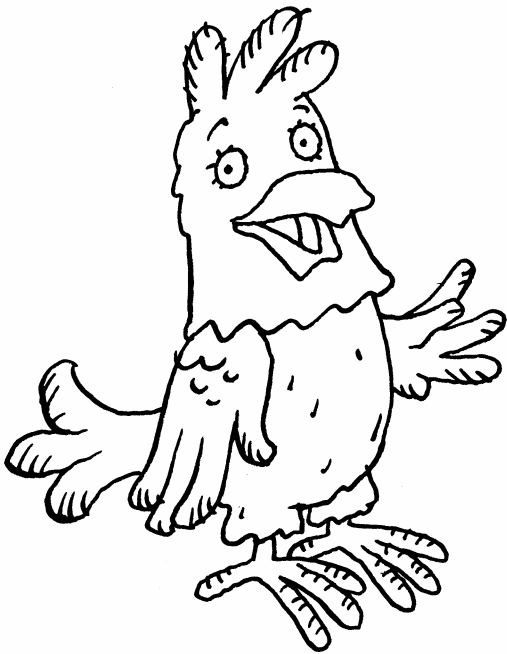

Peter

Pavel

Peter



Mrs Bell

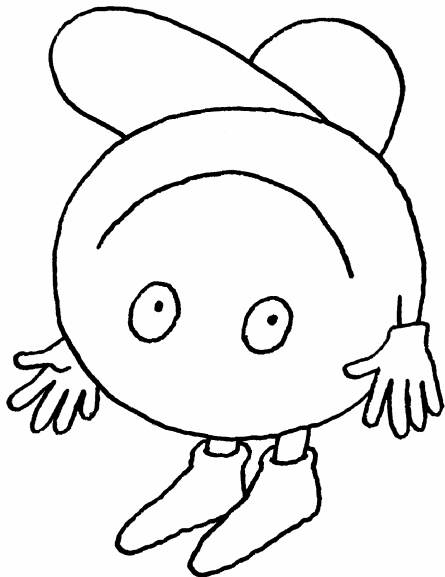

Topsy
Turvey

Mrs Bell

Topsy
Turvey

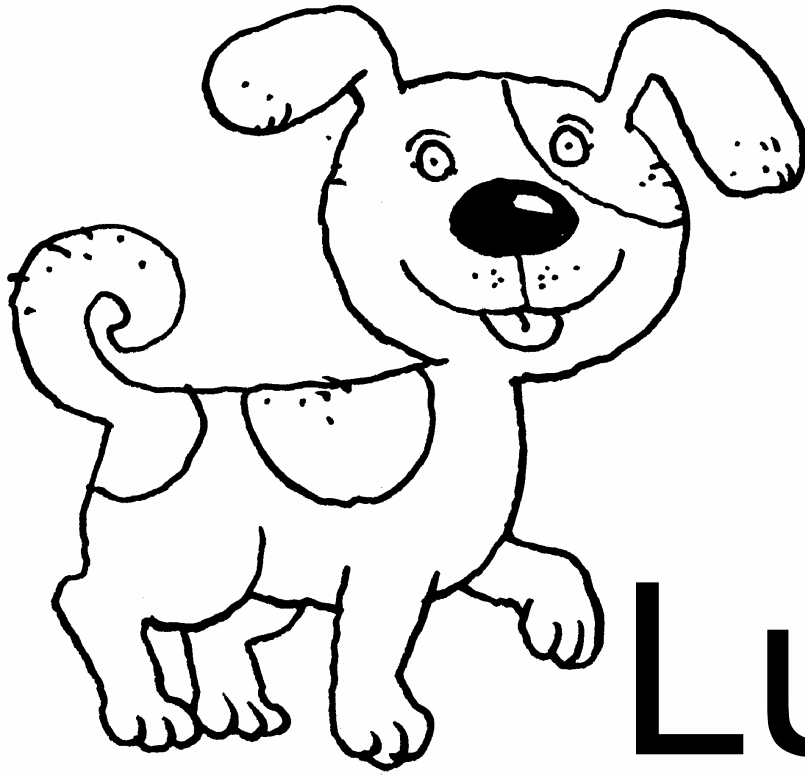

Lucky

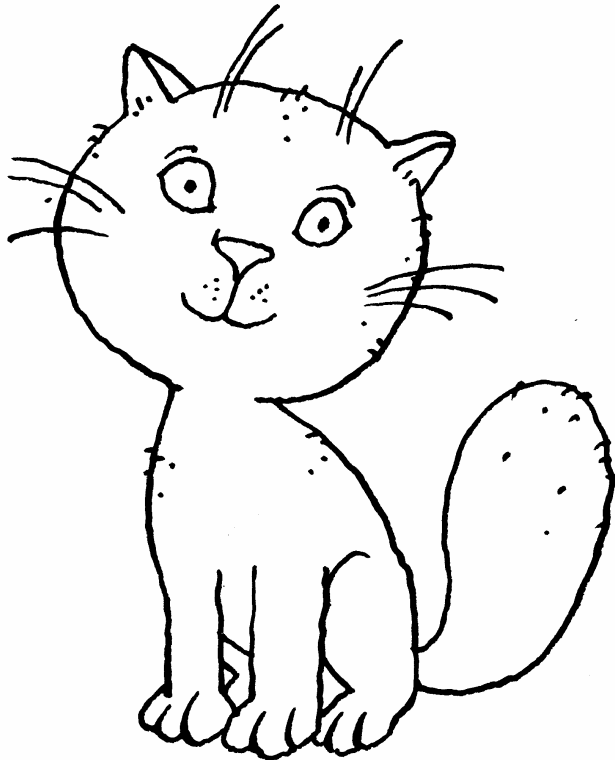

Fluffy

Lucky

Fluffy



Mr Compy

Mr Compy





a mum

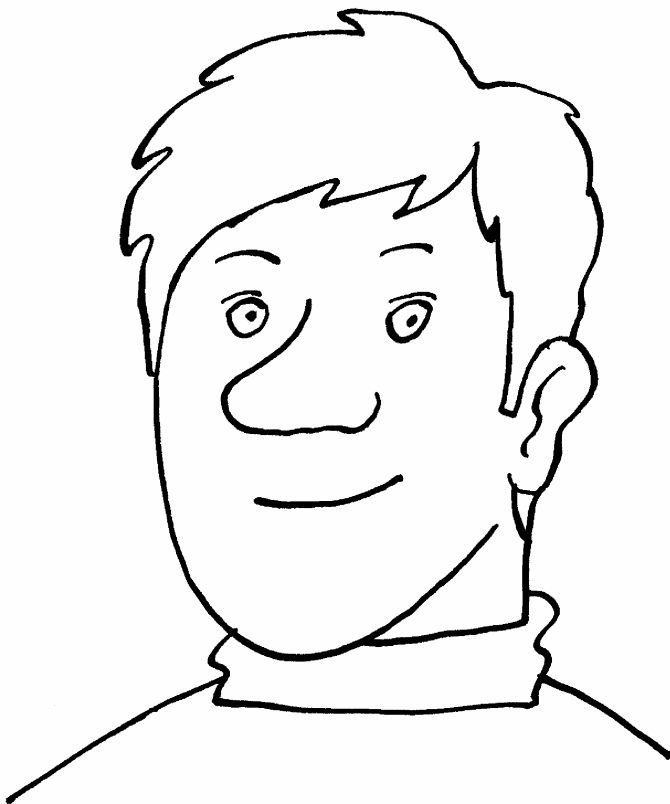

a dad

a mum



a dad



a brother

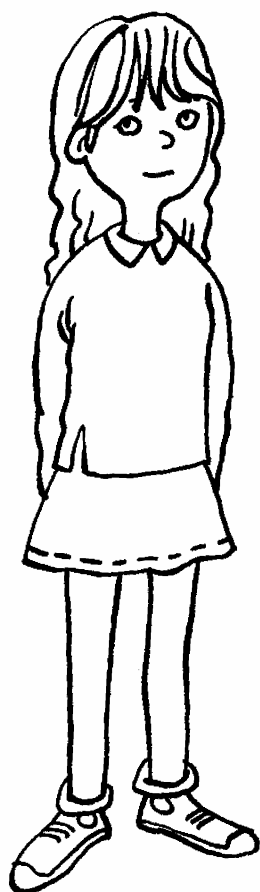

a sister

a brother

a sister

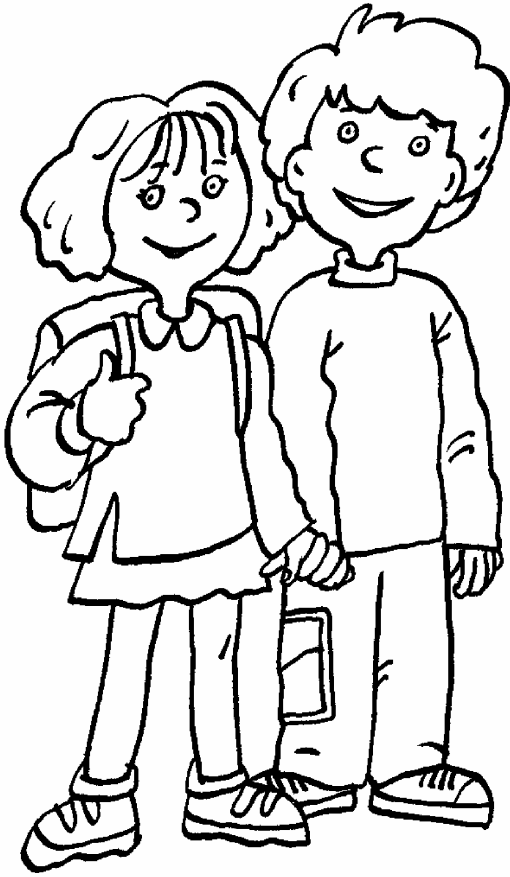

cousins



Africa

cousins

Africa

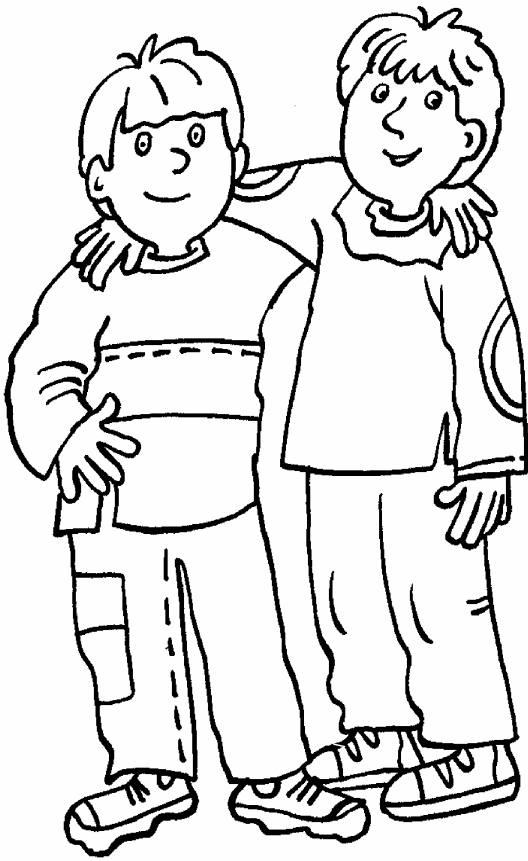

friends

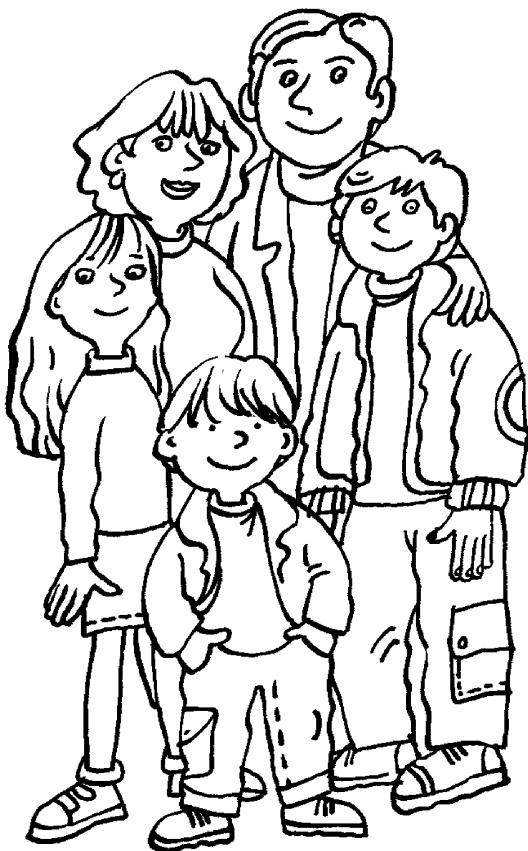

family

friends

family



a granny

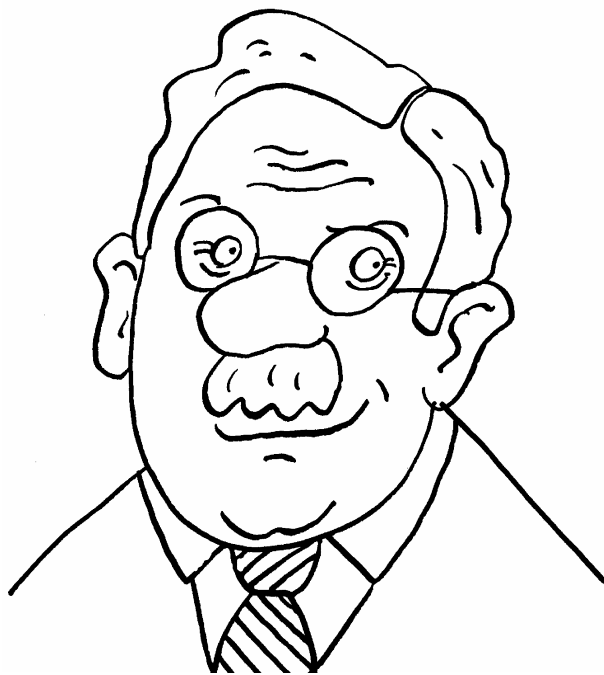

a granddad

a granny

a granddad



a pupil



a cook

a pupil

a cook



a businessman

a doctor



a businessman

a doctor



a teacher



a baby

a teacher

a baby

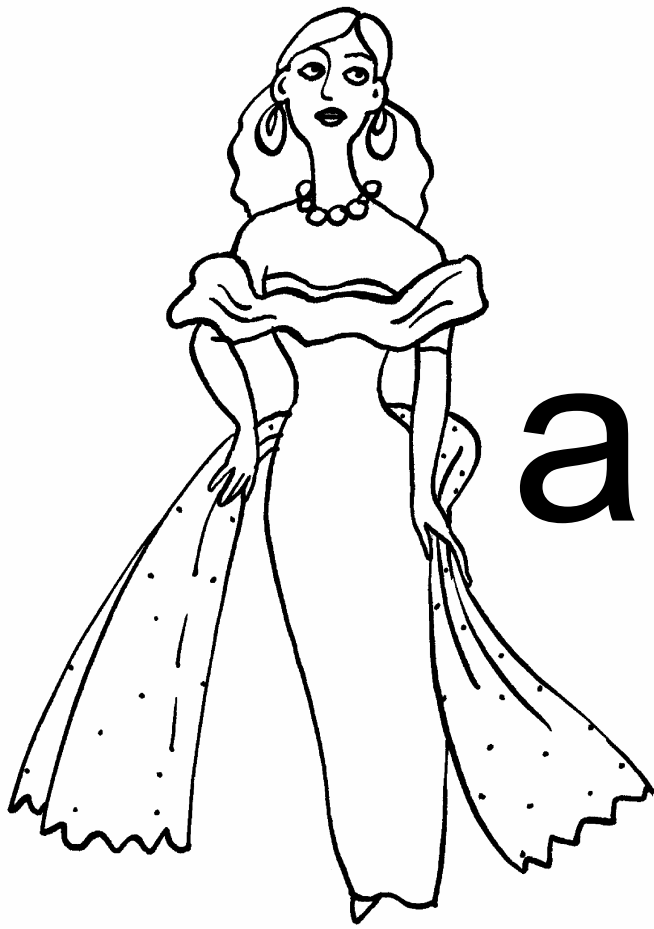

a model



a dentist

a model

a dentist



an uncle

an auntie



an uncle



an auntie

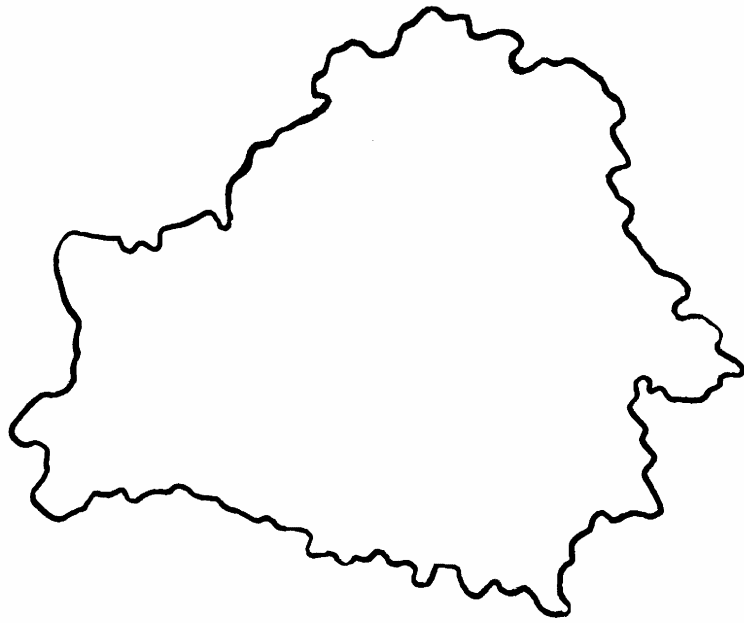

Belarus



Britain

Belarus

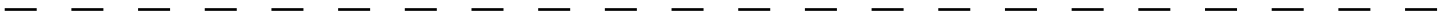

Britain

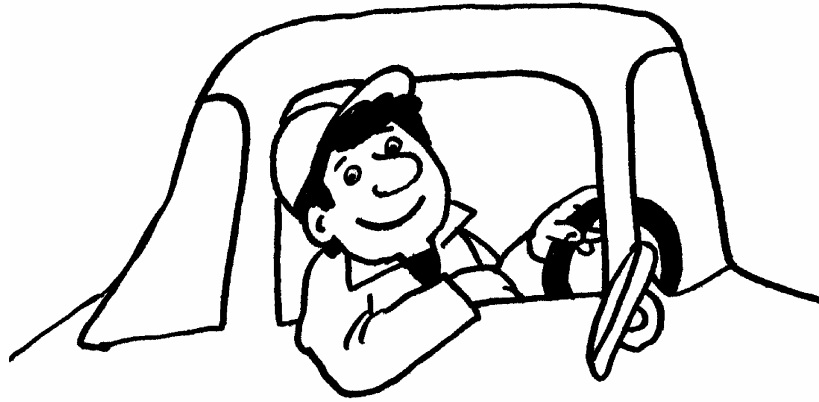

a driver



a farmer

a driver

a farmer

a vet

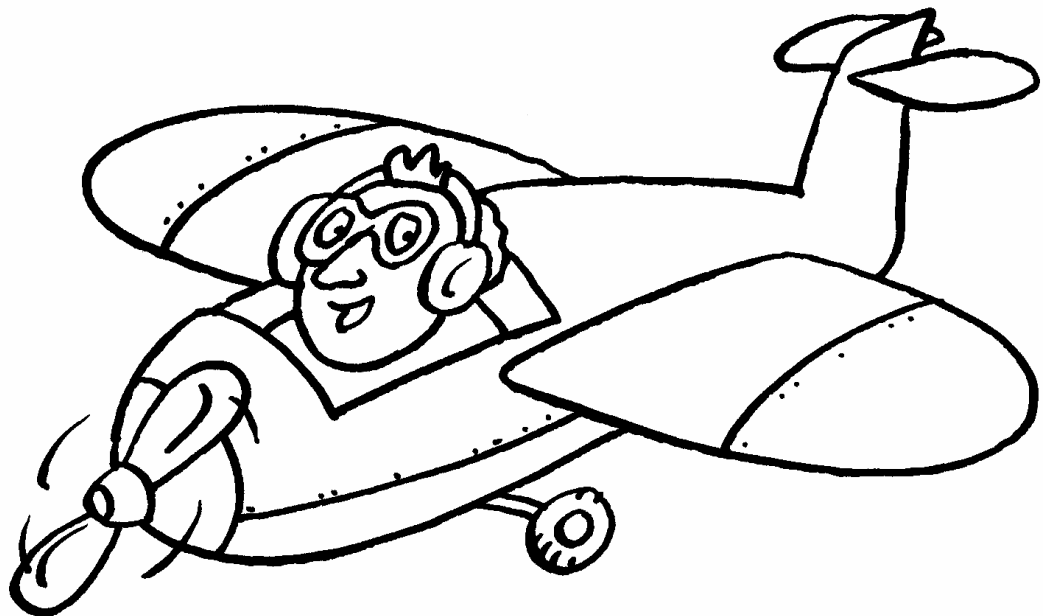

a pilot

a vet

a pilot

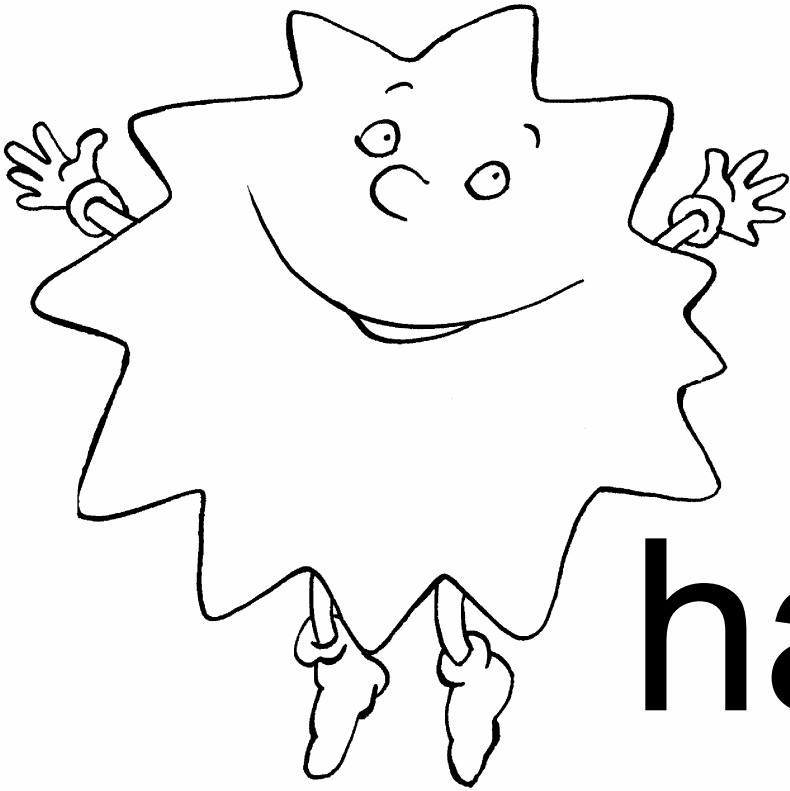

happy

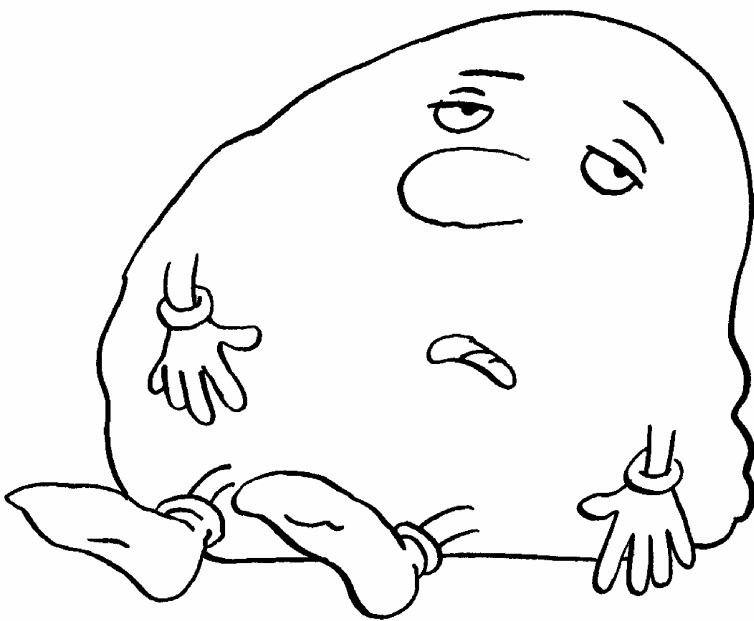

tired

happy

tired

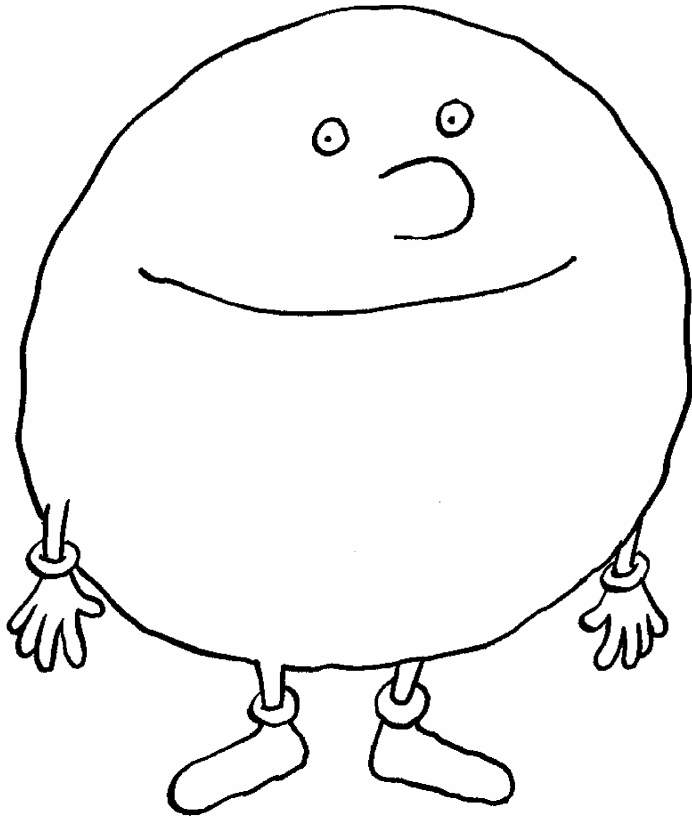

big

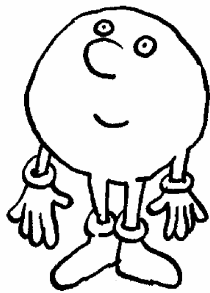

little

big



little

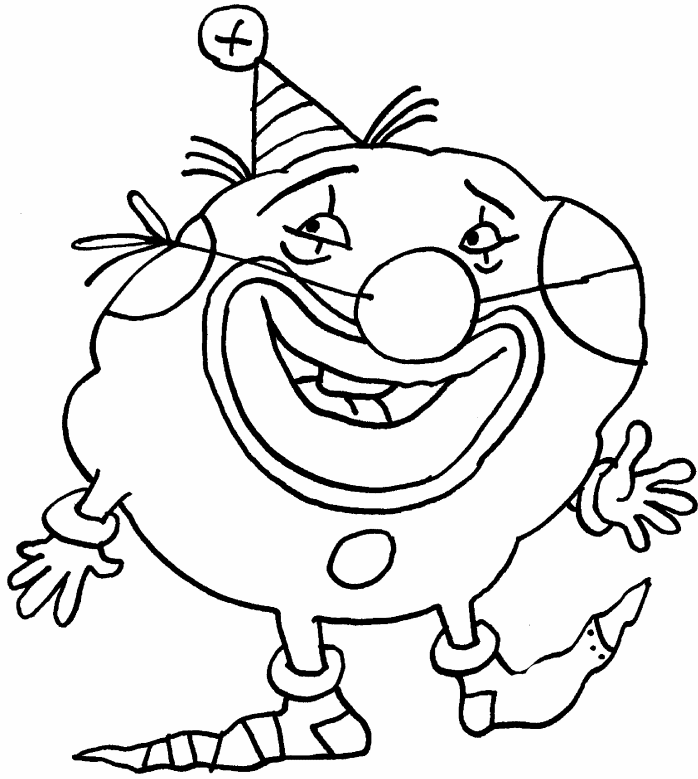

funny

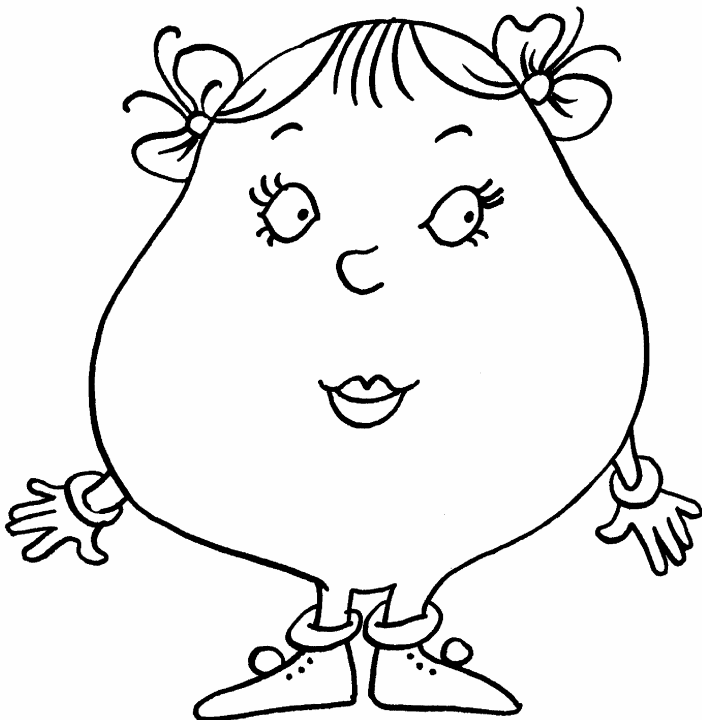

nice

funny

nice

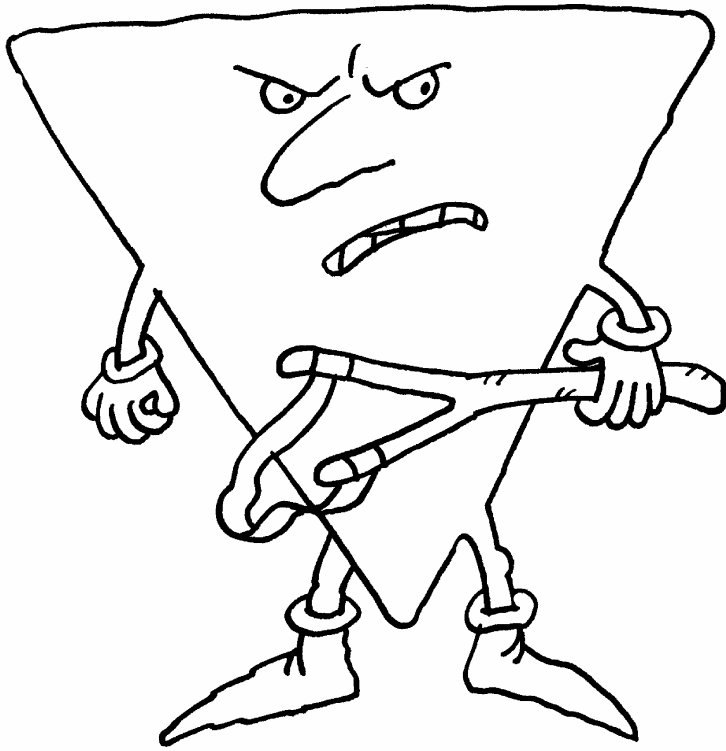

bad

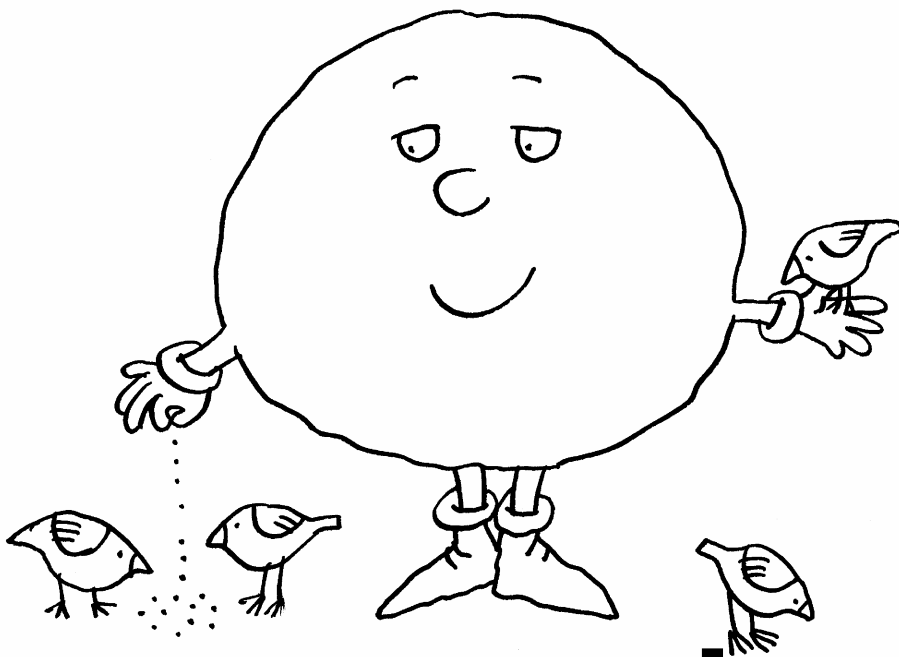

good

bad



good

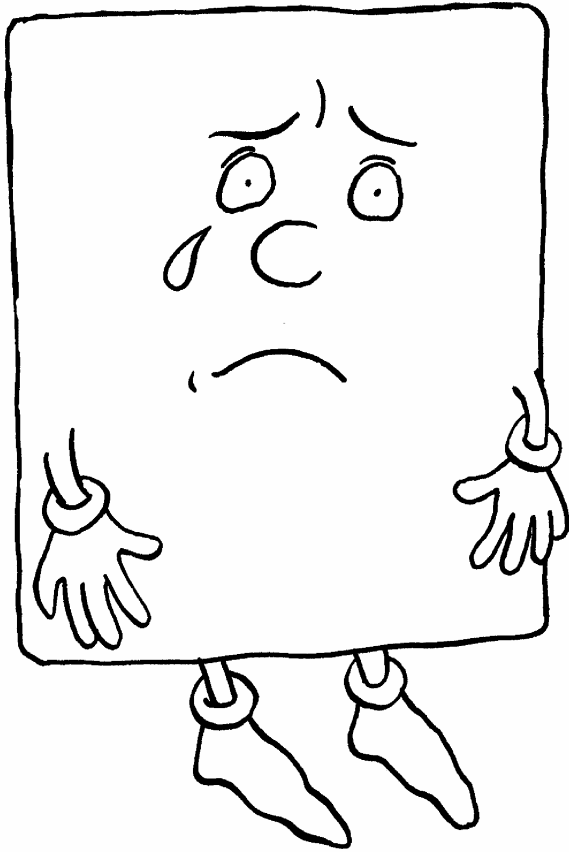

sad

kind

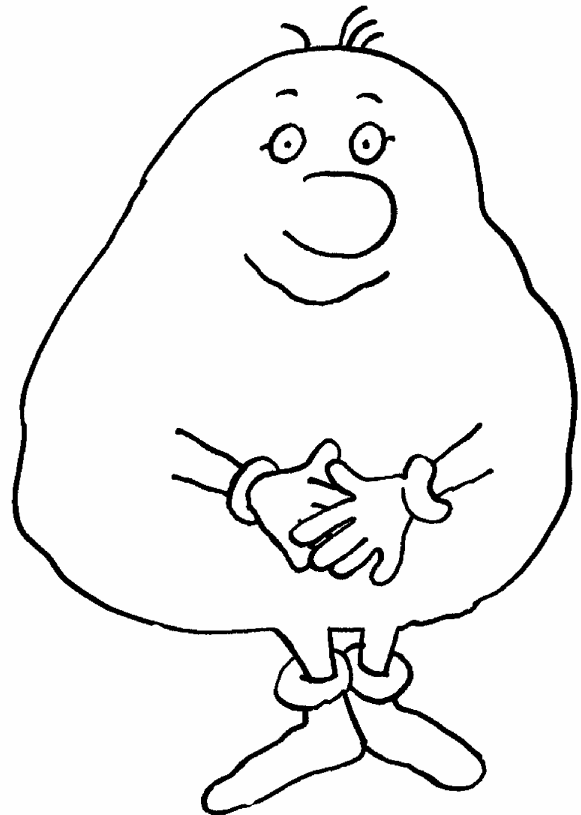

sad



kind

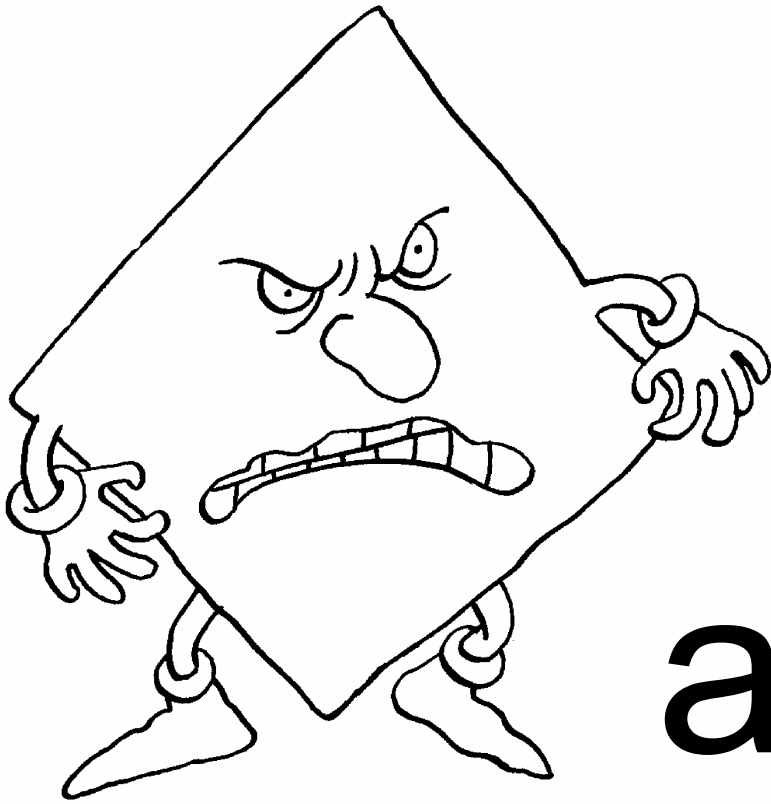

angry



America

angry

America



hair

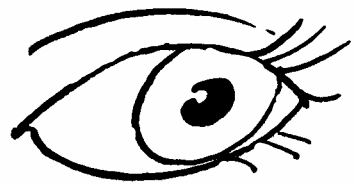
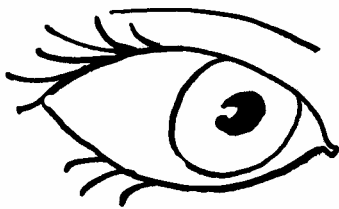

eyes

hair

eyes

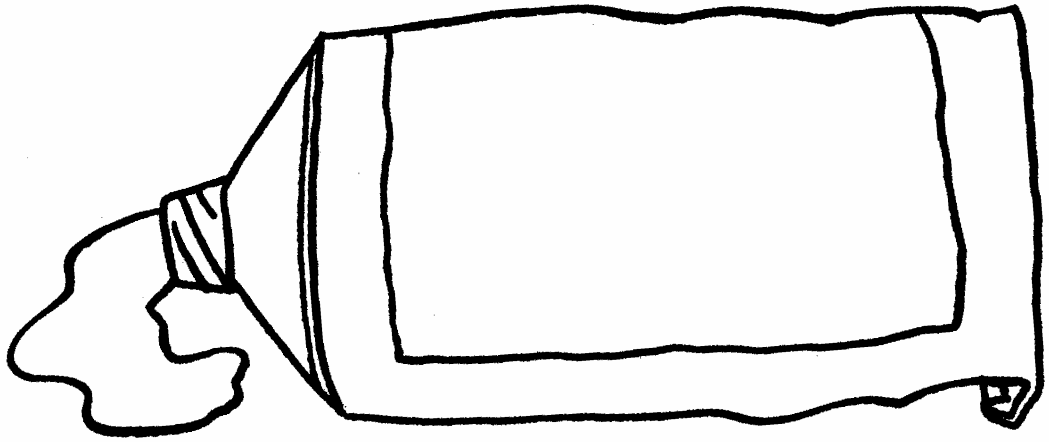

red

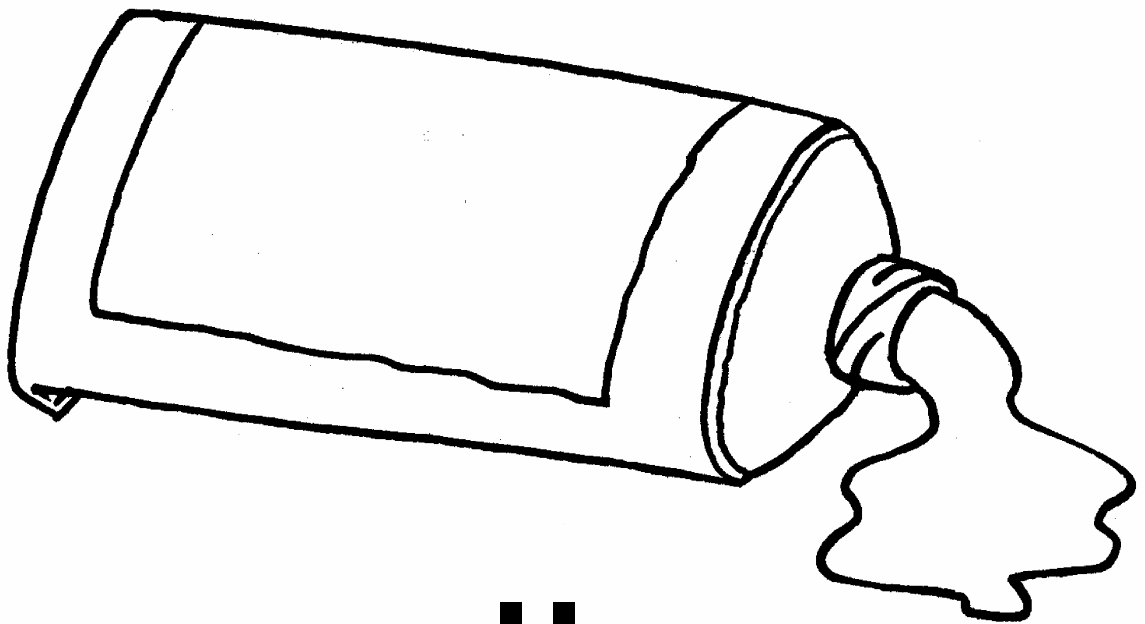

yellow

red



yellow

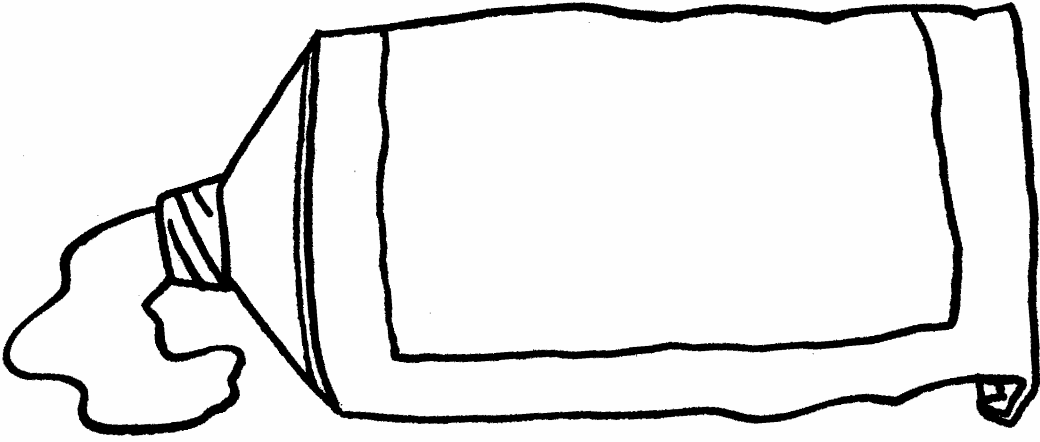

pink

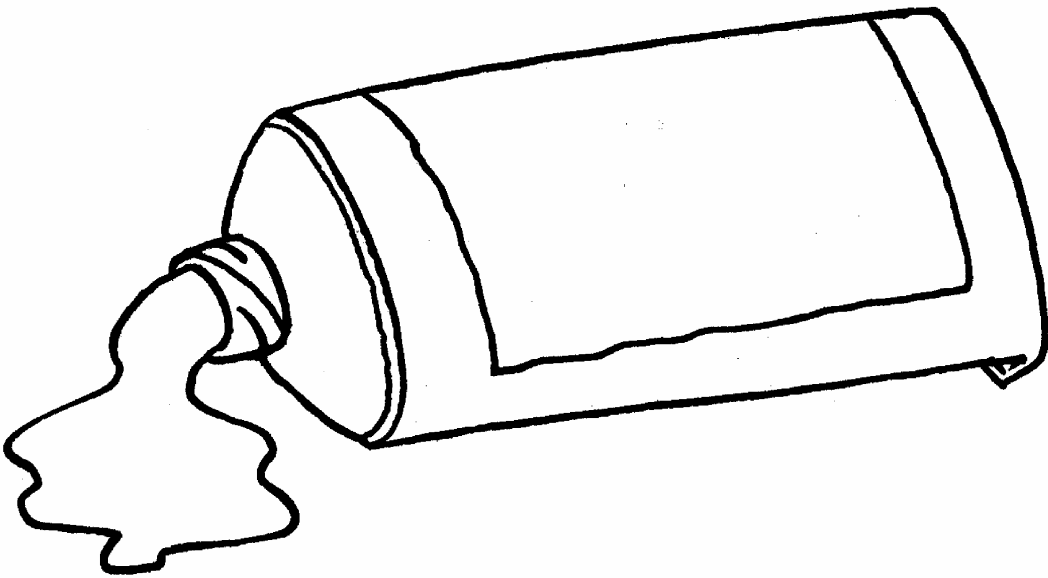

green

pink

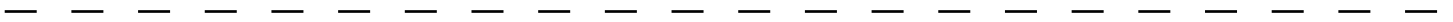

green

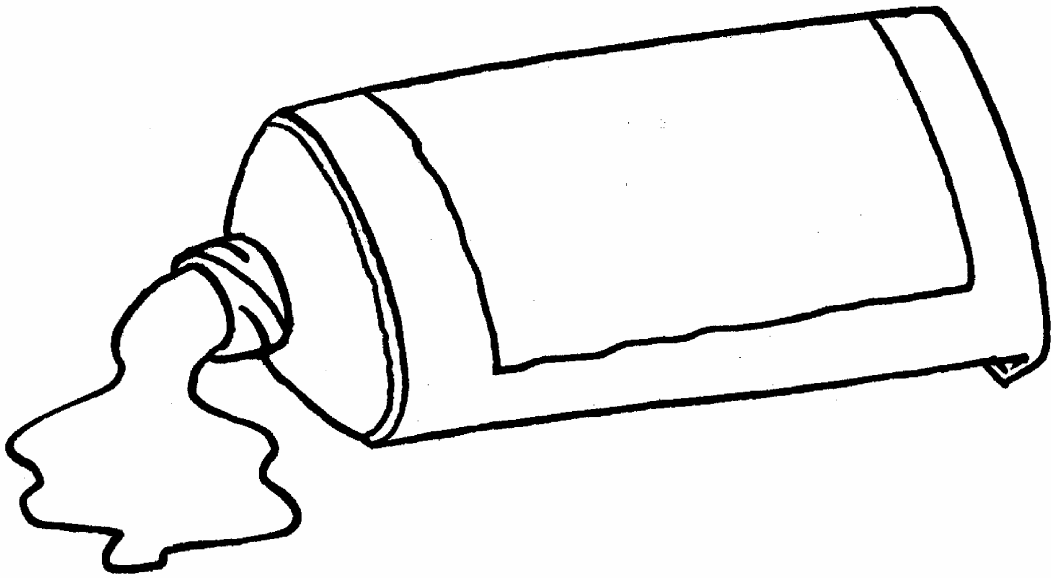

purple

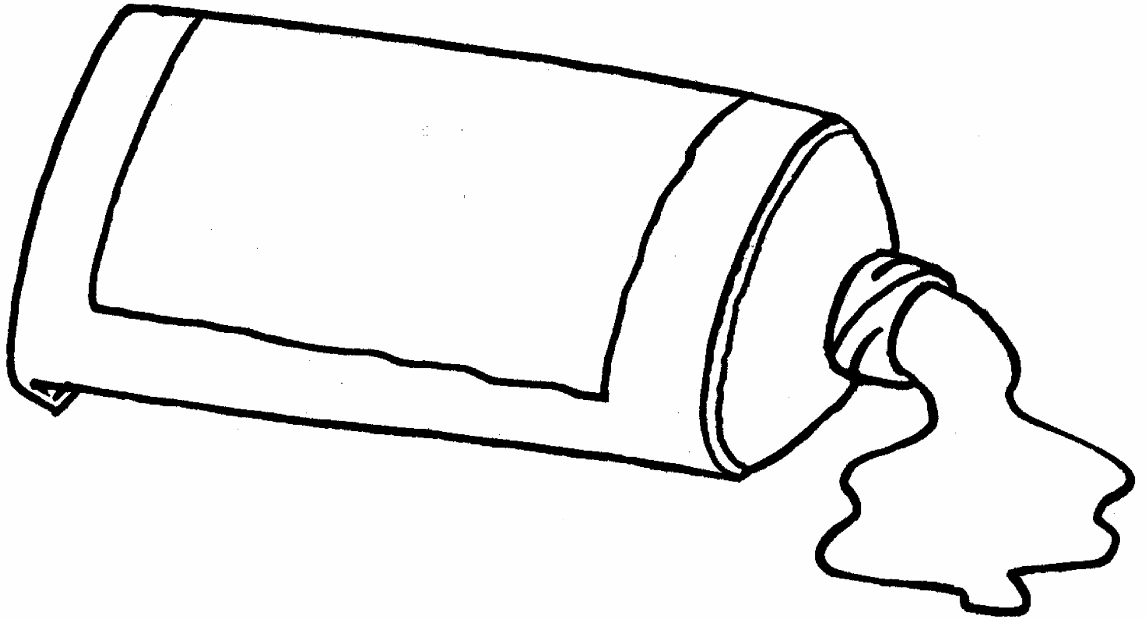

orange

purple



orange

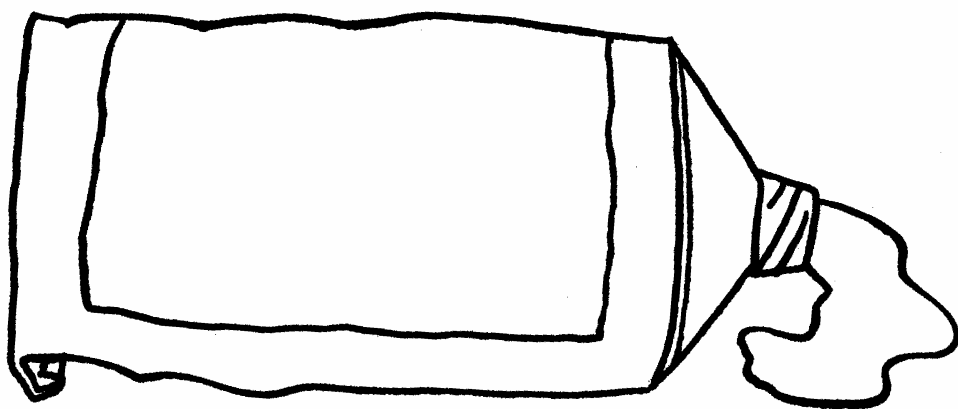

bue

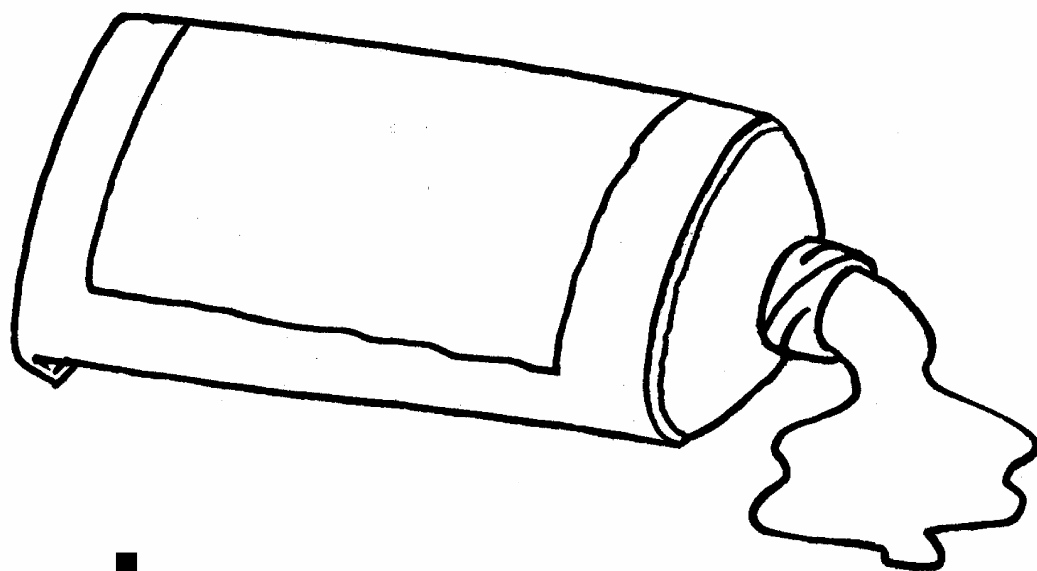

brown

bue



brown

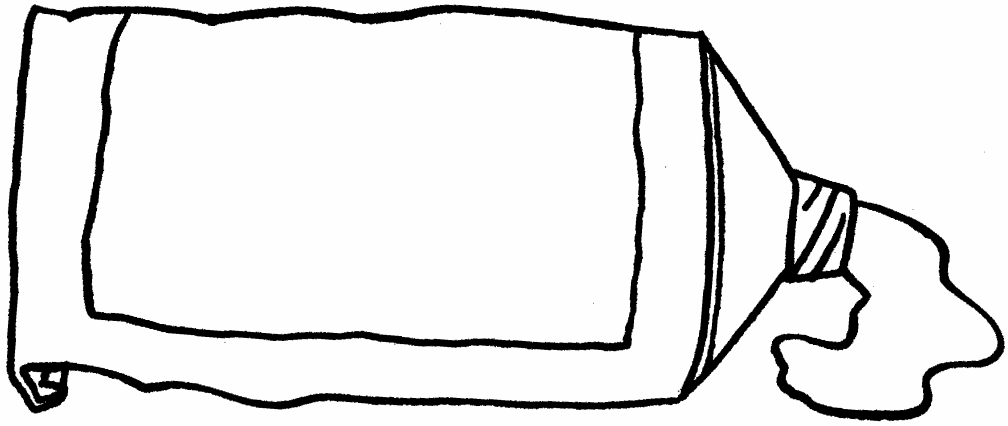

grey

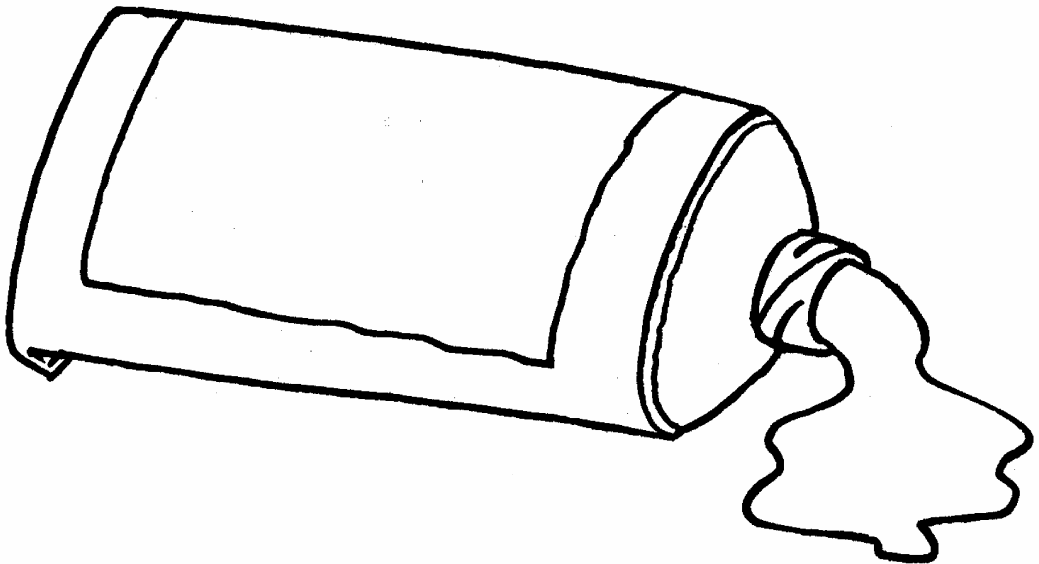

white

grey



white

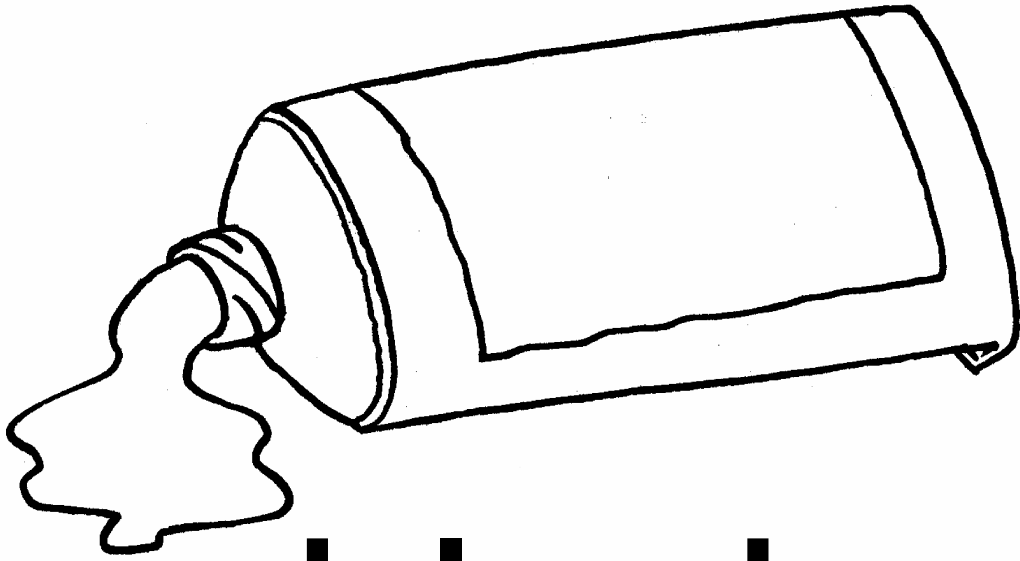

black

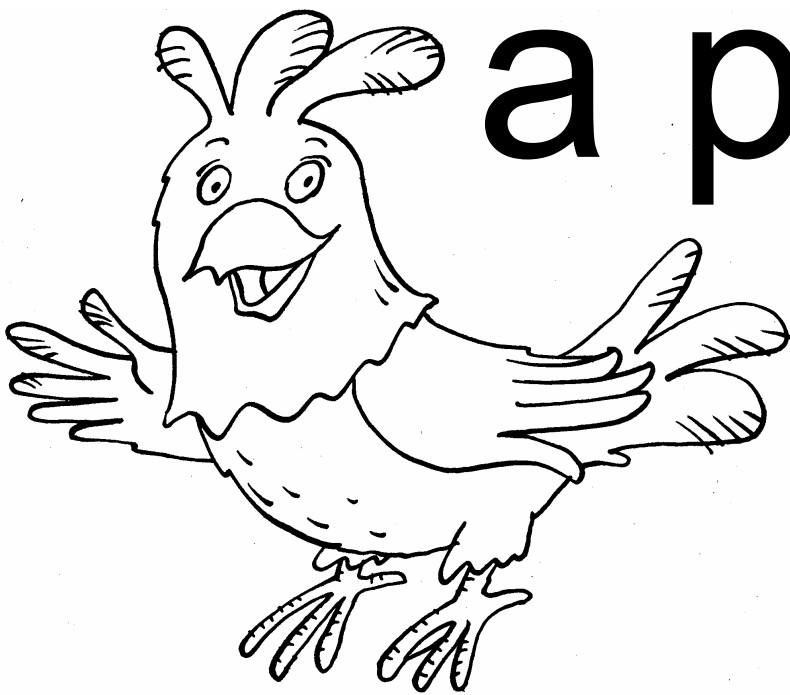

a parrot

black

a parrot

a cat

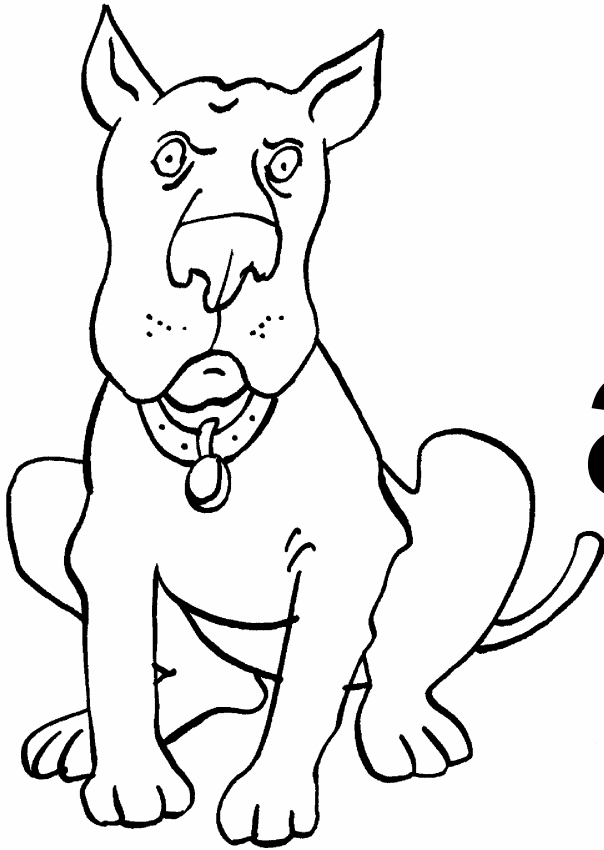
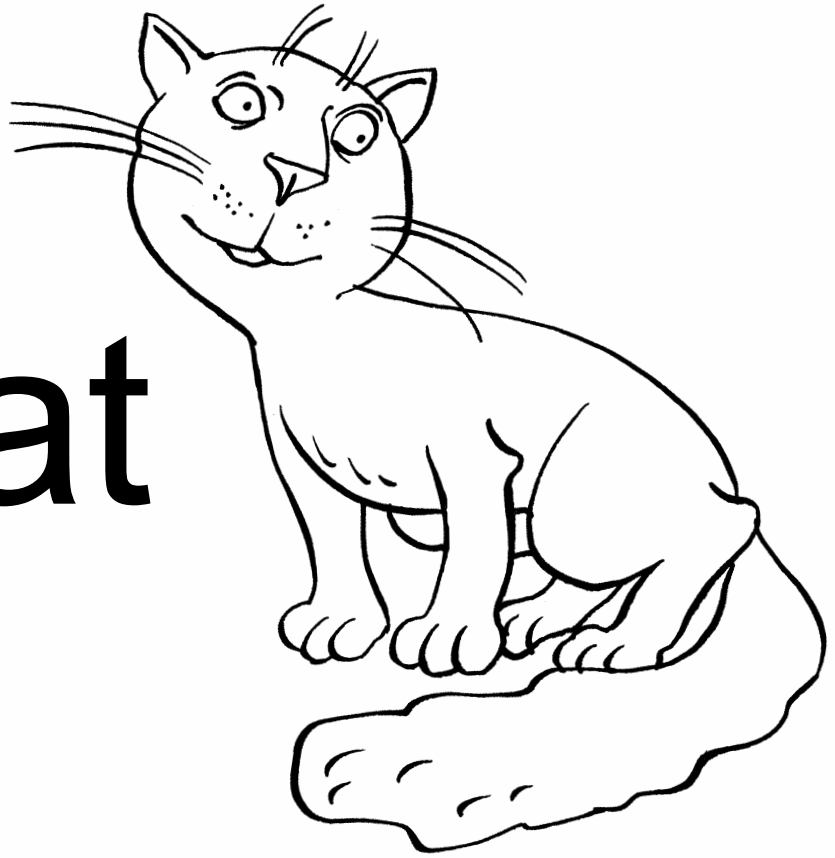

a dog

a cat

a dog

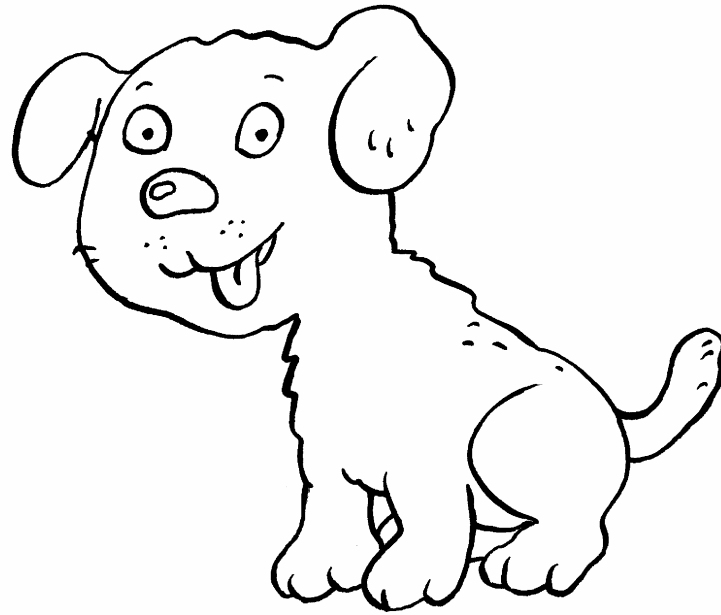

a puppy

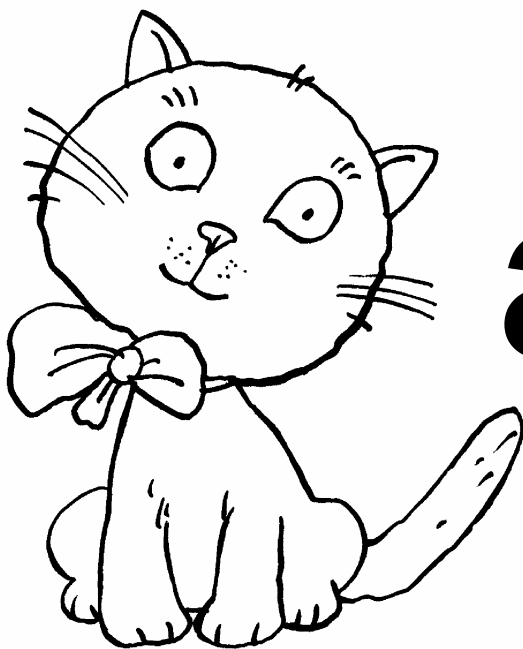

a kitten

a puppy

a kitten



a frog

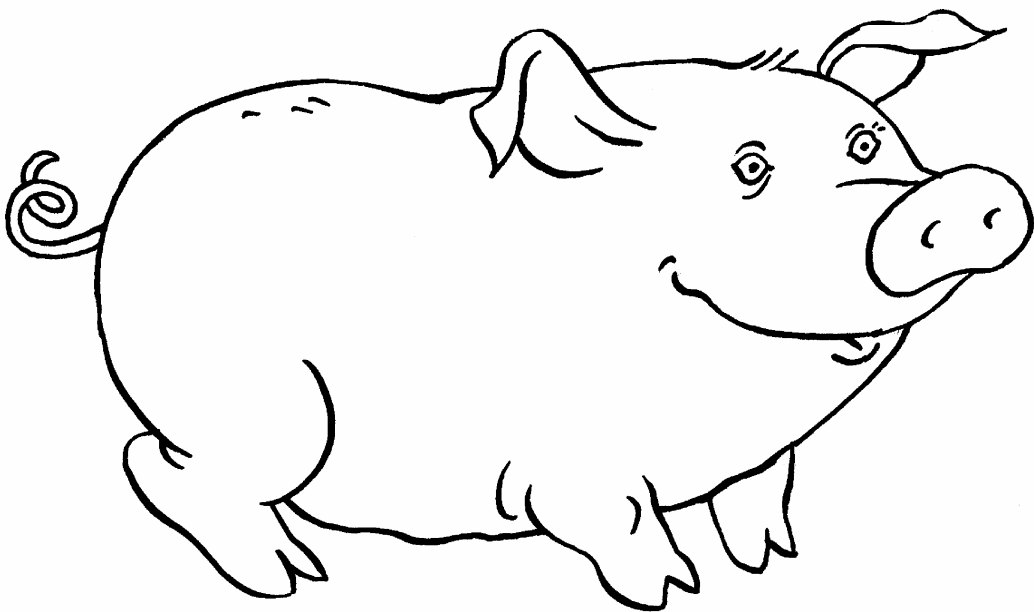

a pig

a frog

a pig

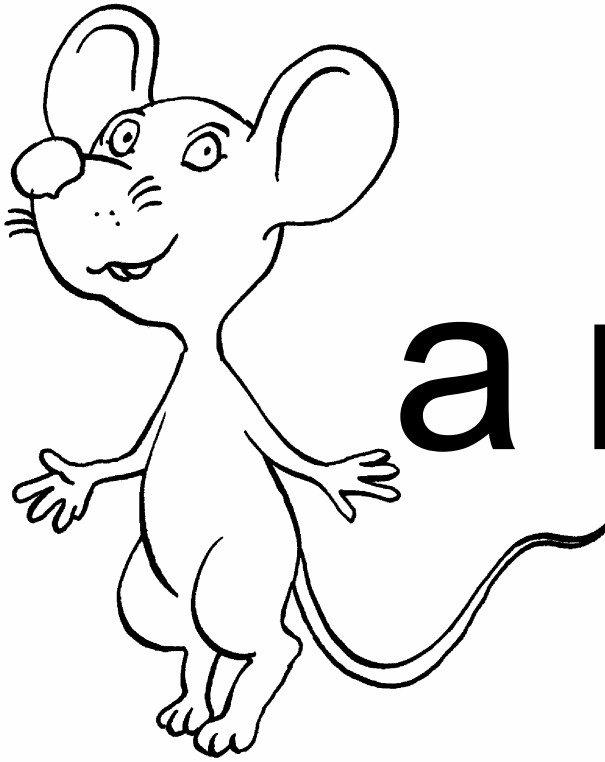

a mouse

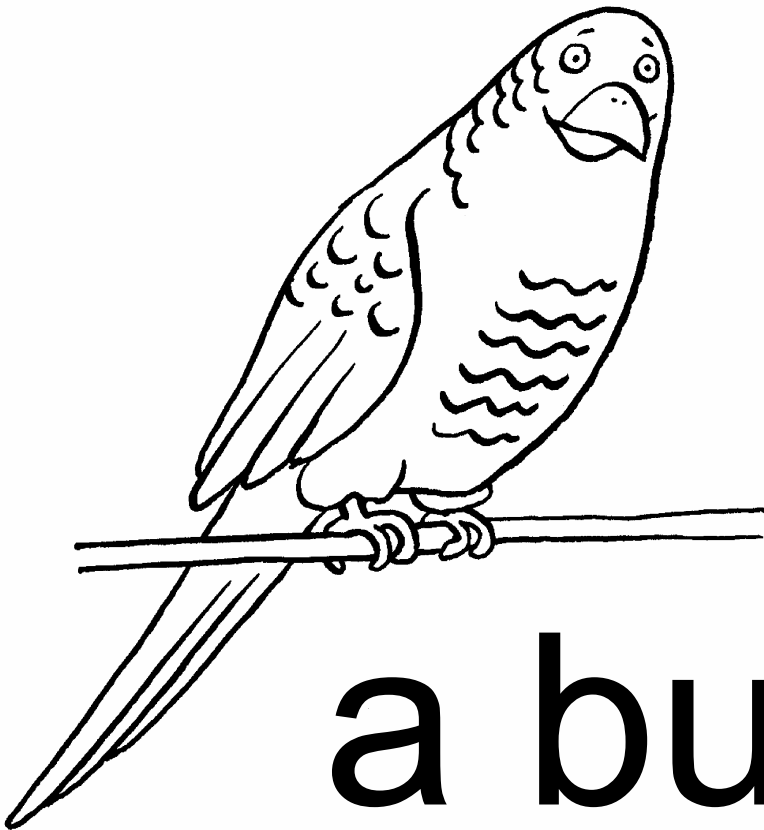

a budgie

a mouse

a budgie



a hamster

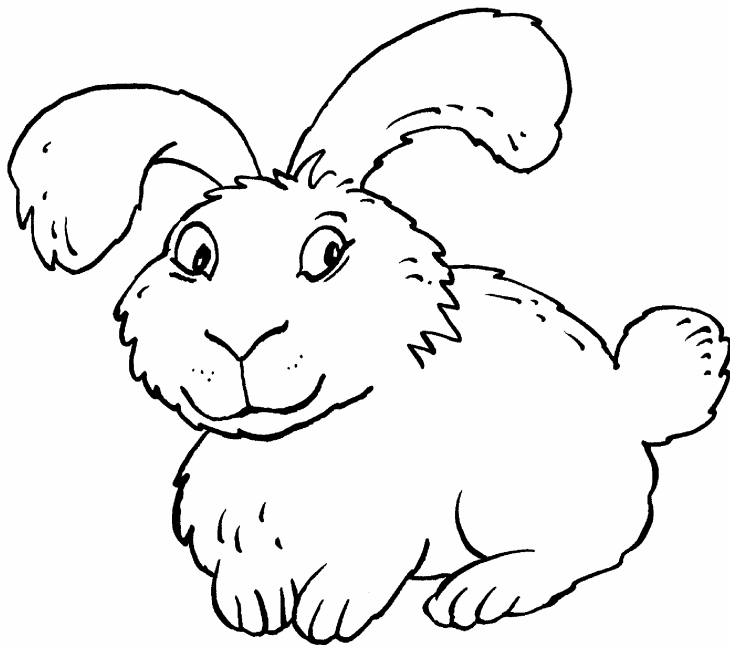

a rabbit

a hamster

a rabbit

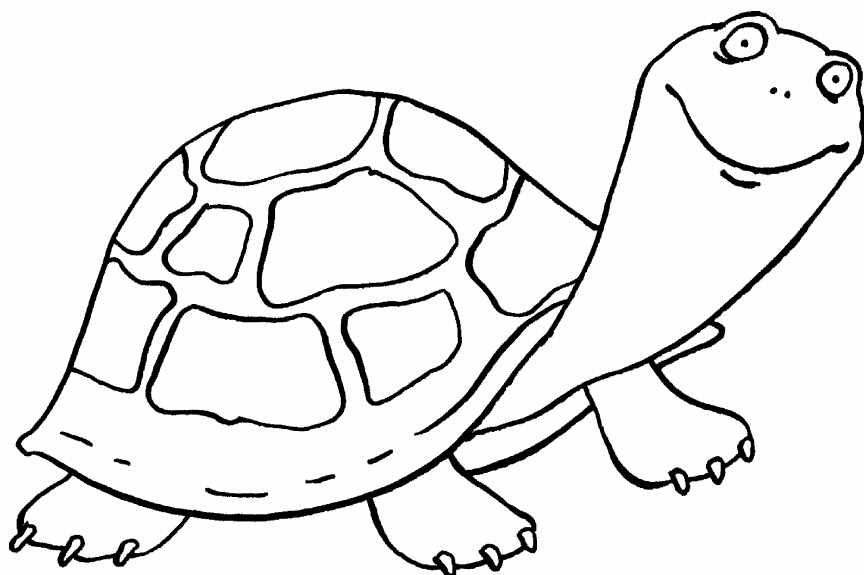

a tortoise

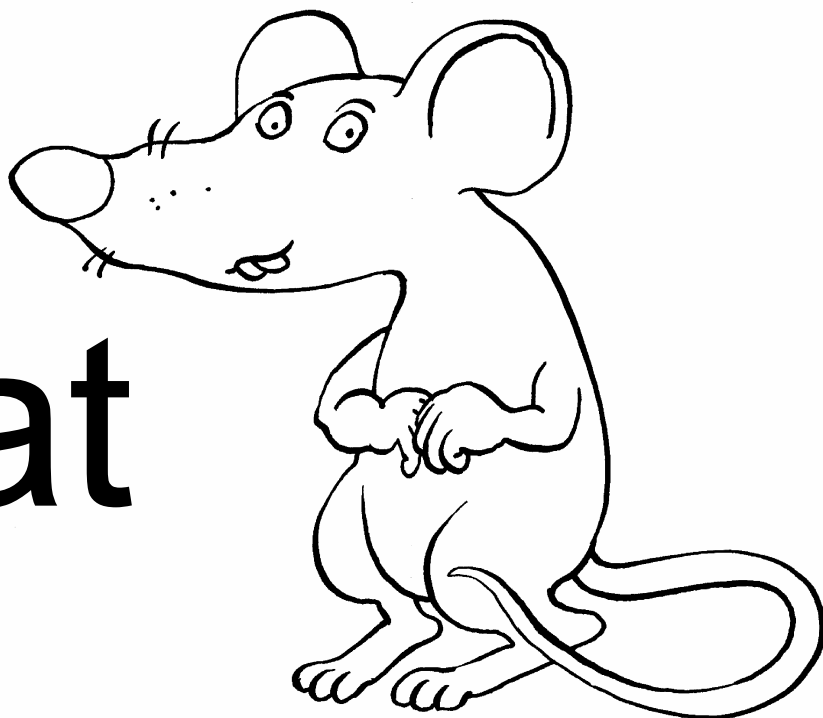

a rat

a tortoise

a rat



a guinea-pig

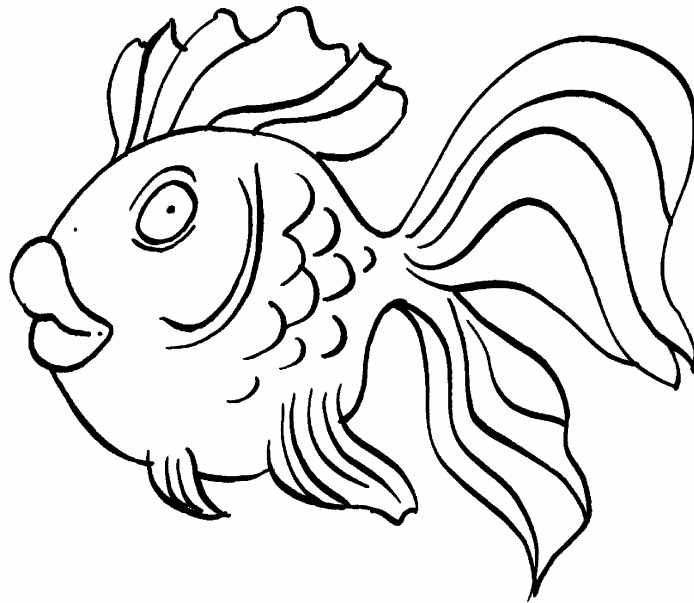

a goldfish

a guinea-pig

a goldfish

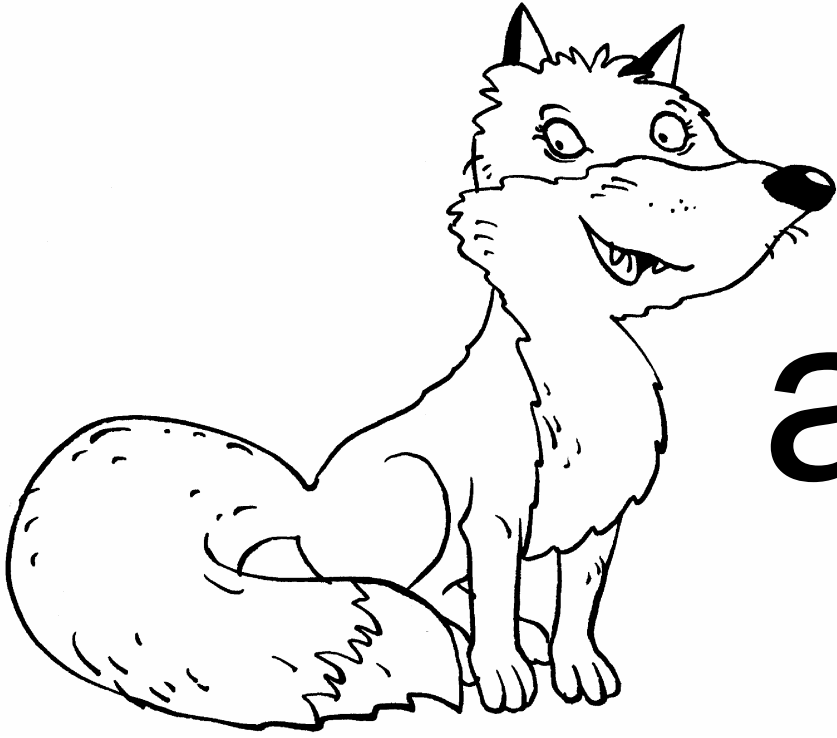

a fox

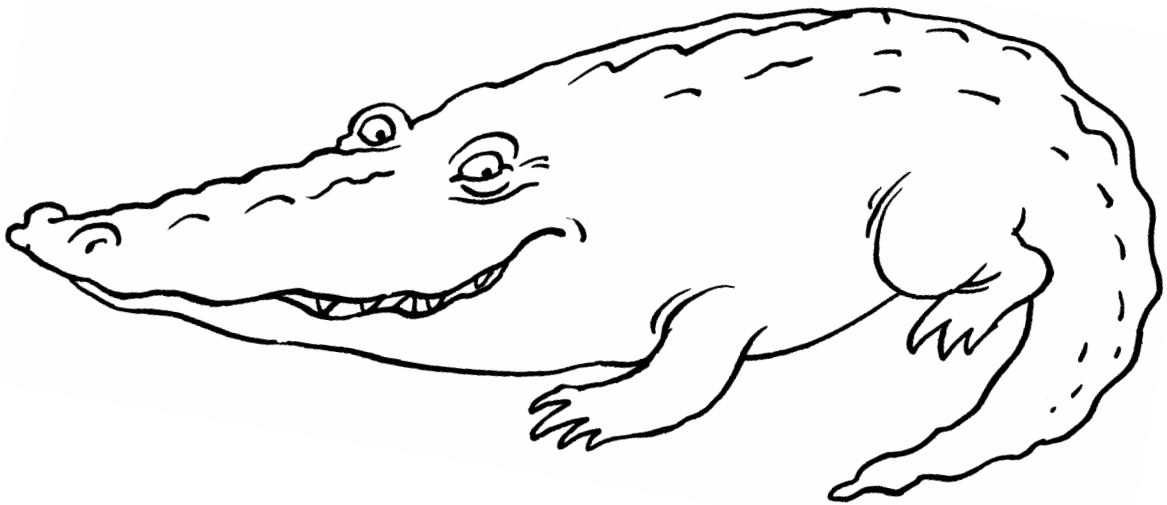

a crocodile

a fox

a crocodile

a bear

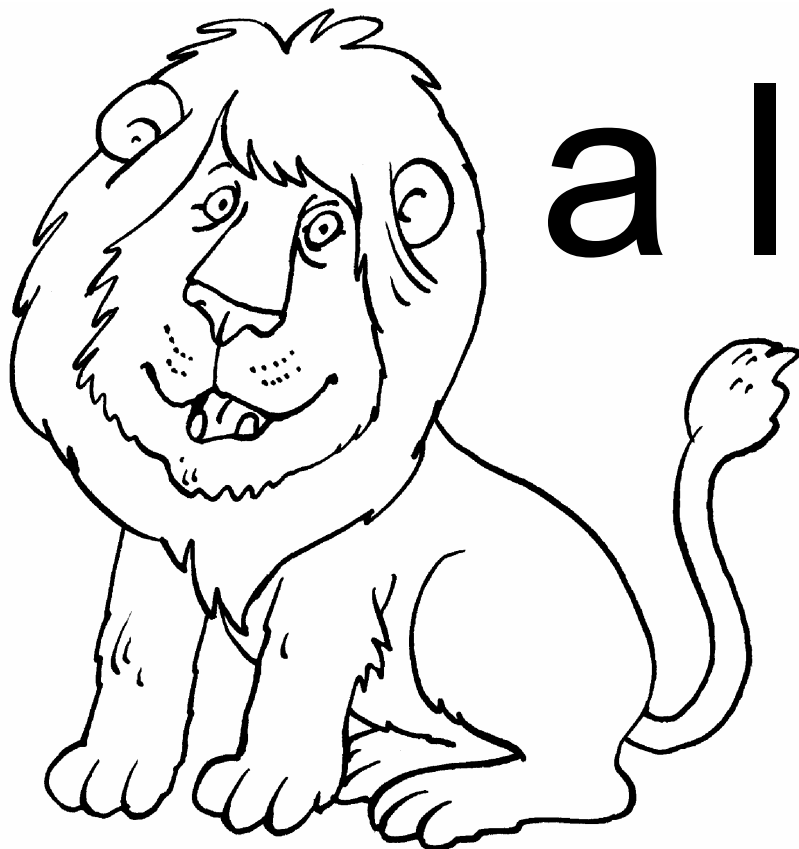
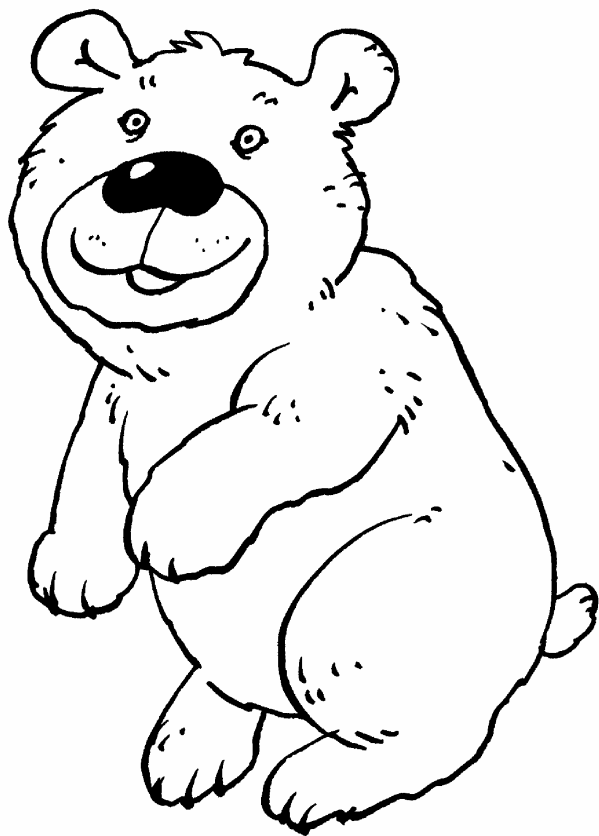

a lion

a bear

a lion

a giraffe

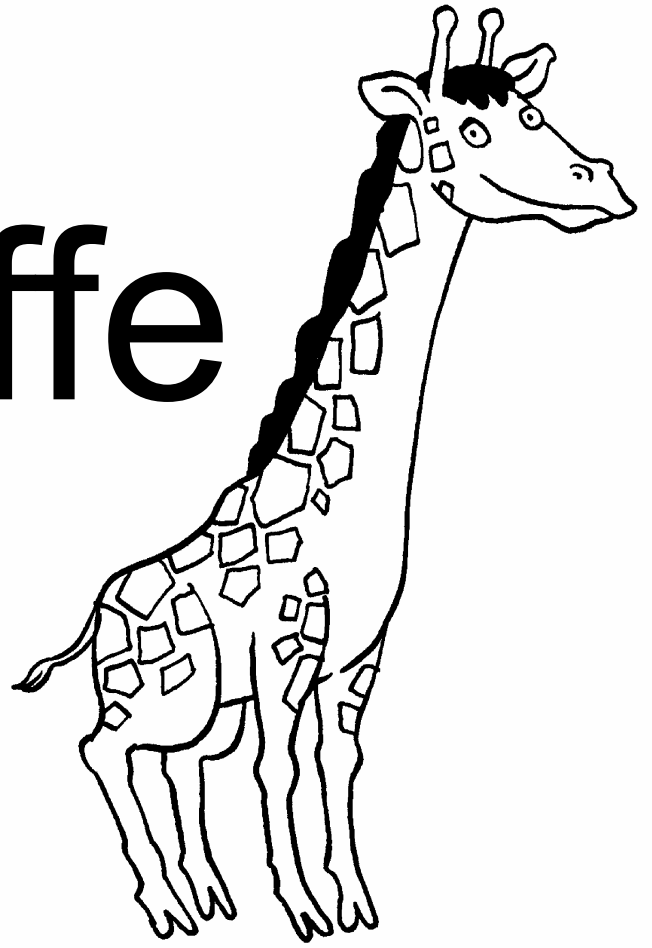

an elephant

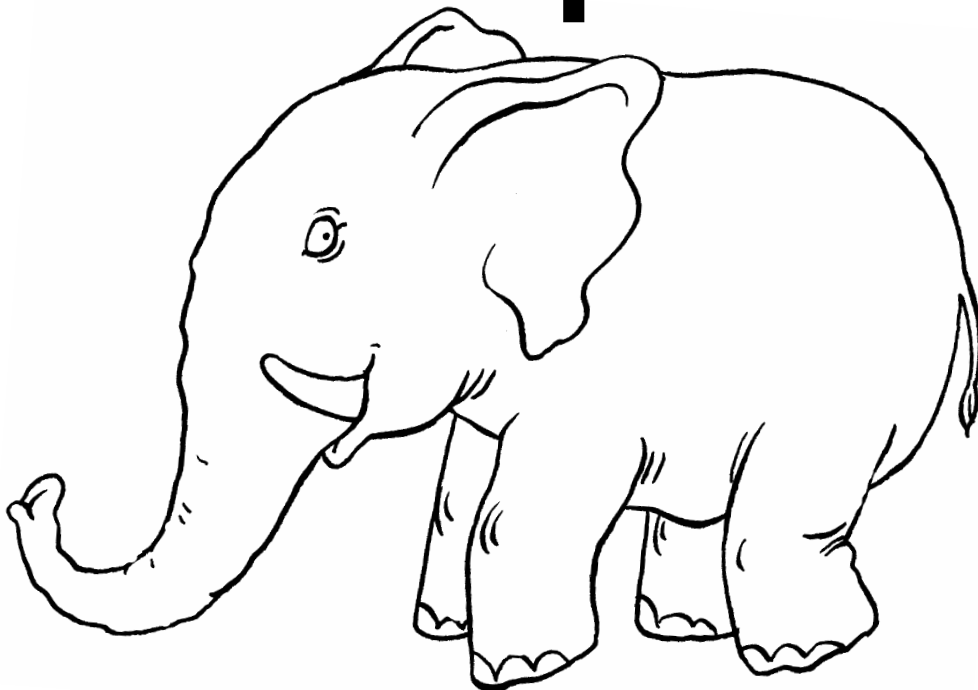

a giraffe

an elephant

a tiger

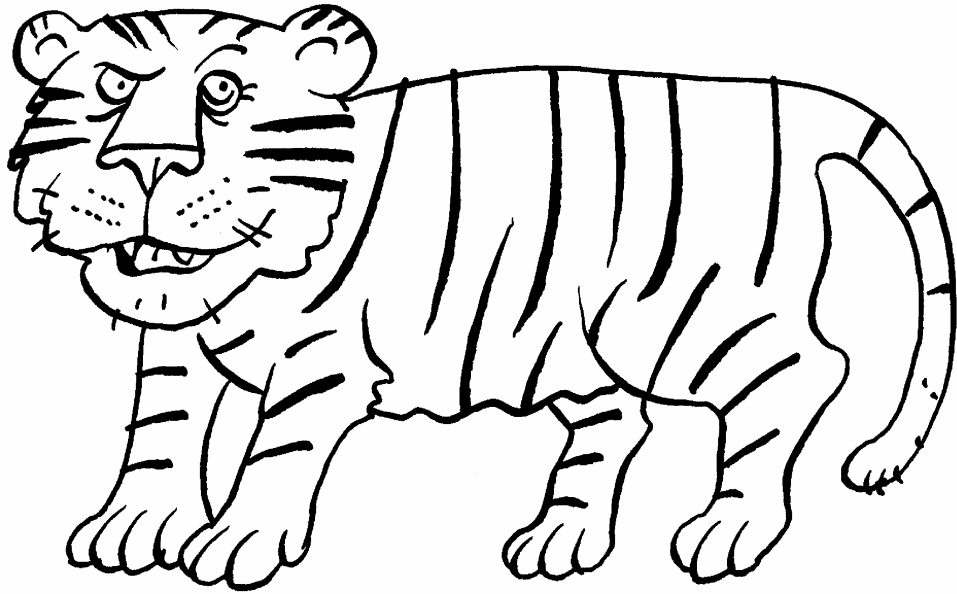

a monkey



a tiger

a monkey

a hippo

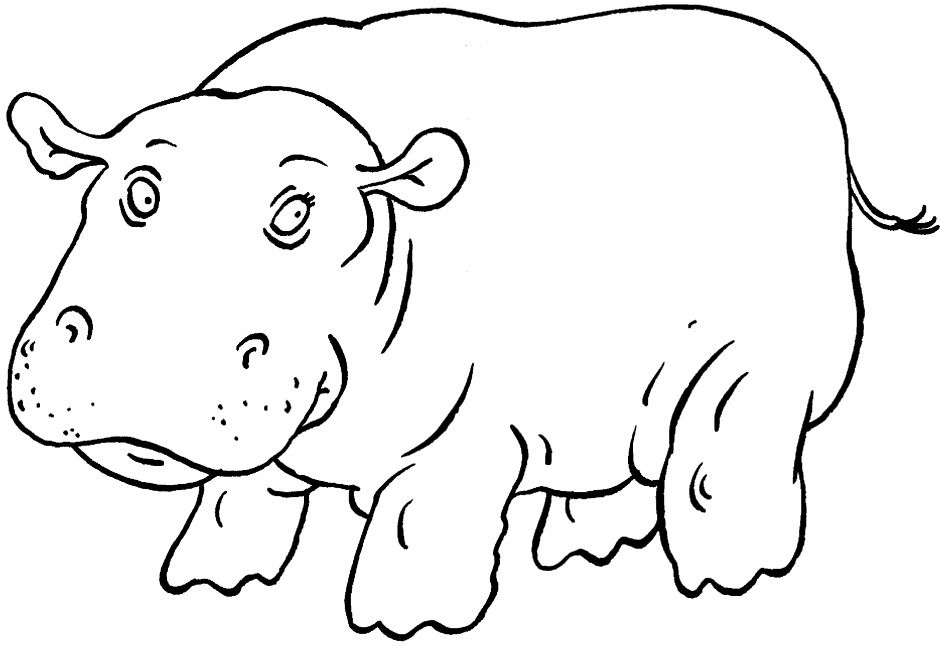

a duck

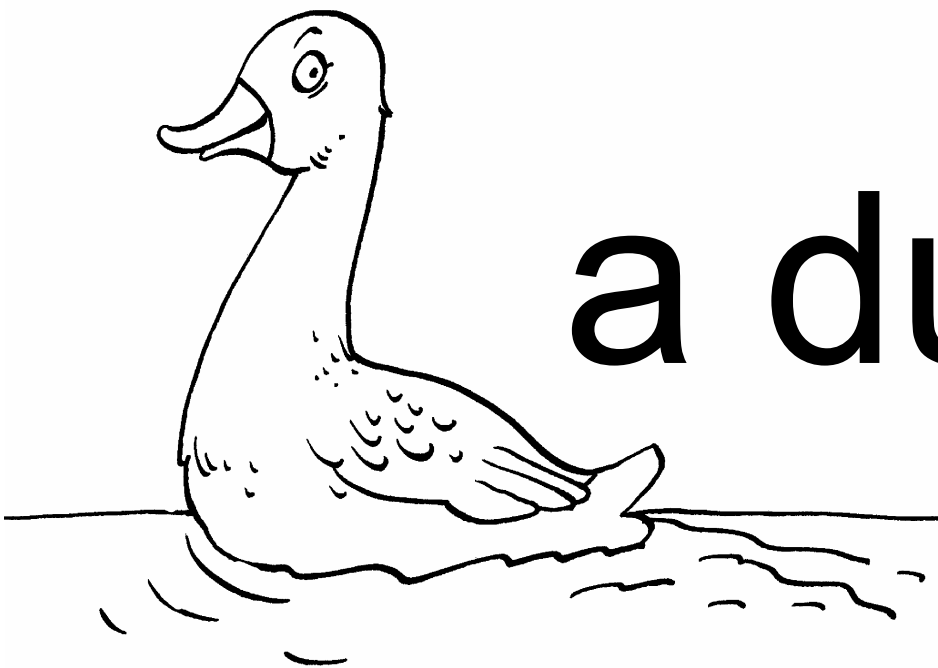

a hippo

a duck

a sheep

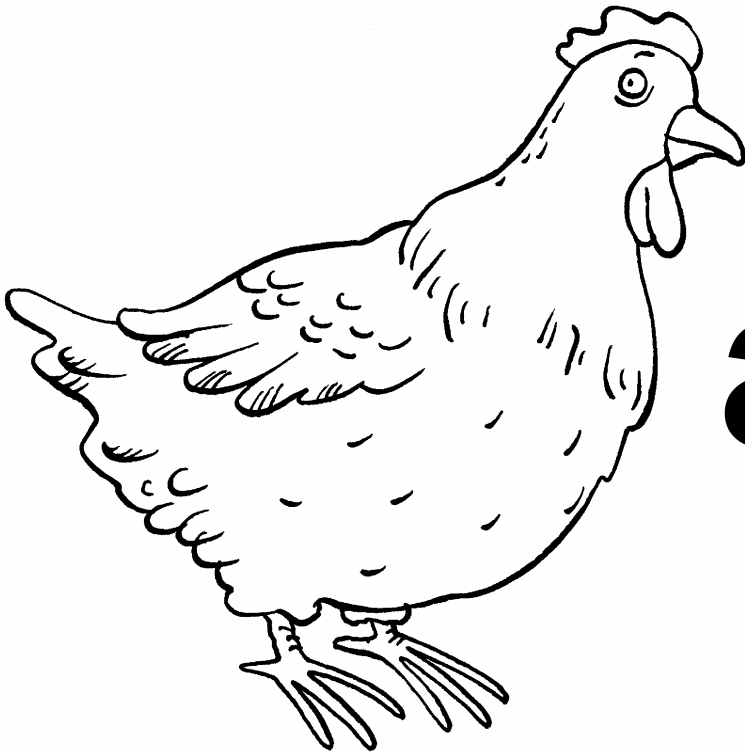
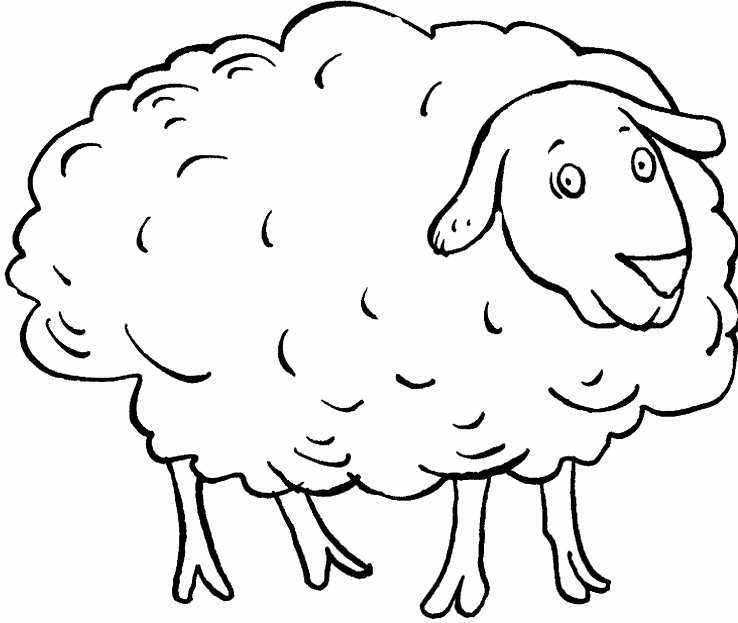

a hen

a sheep

a hen

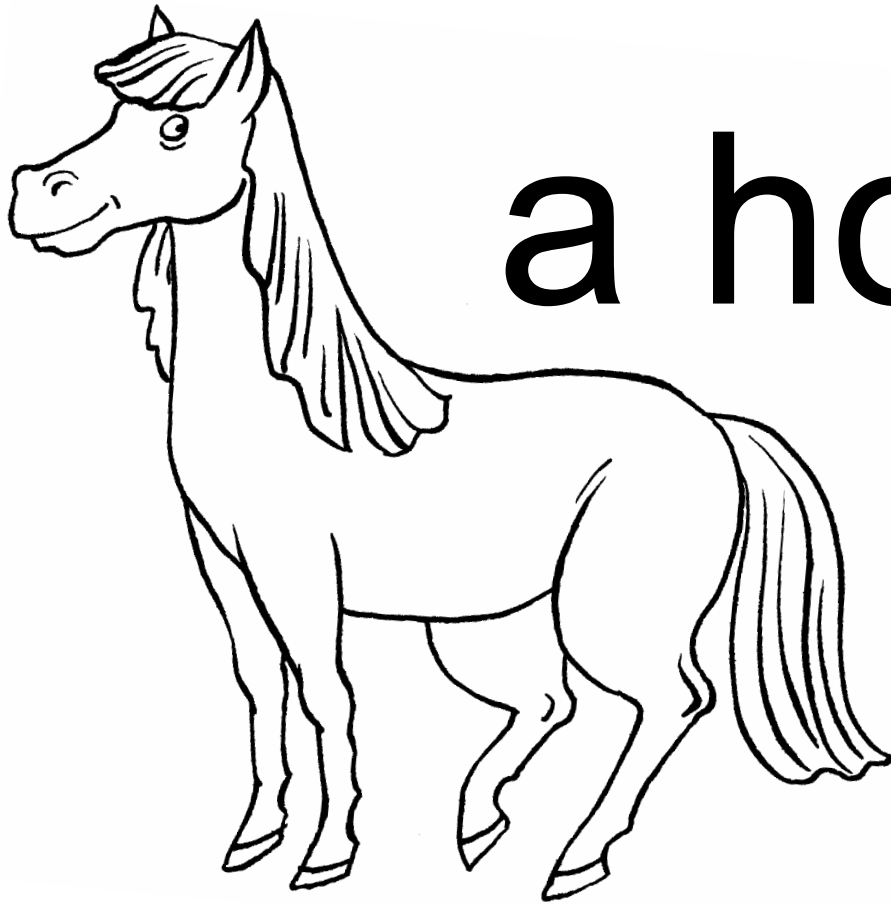

a horse

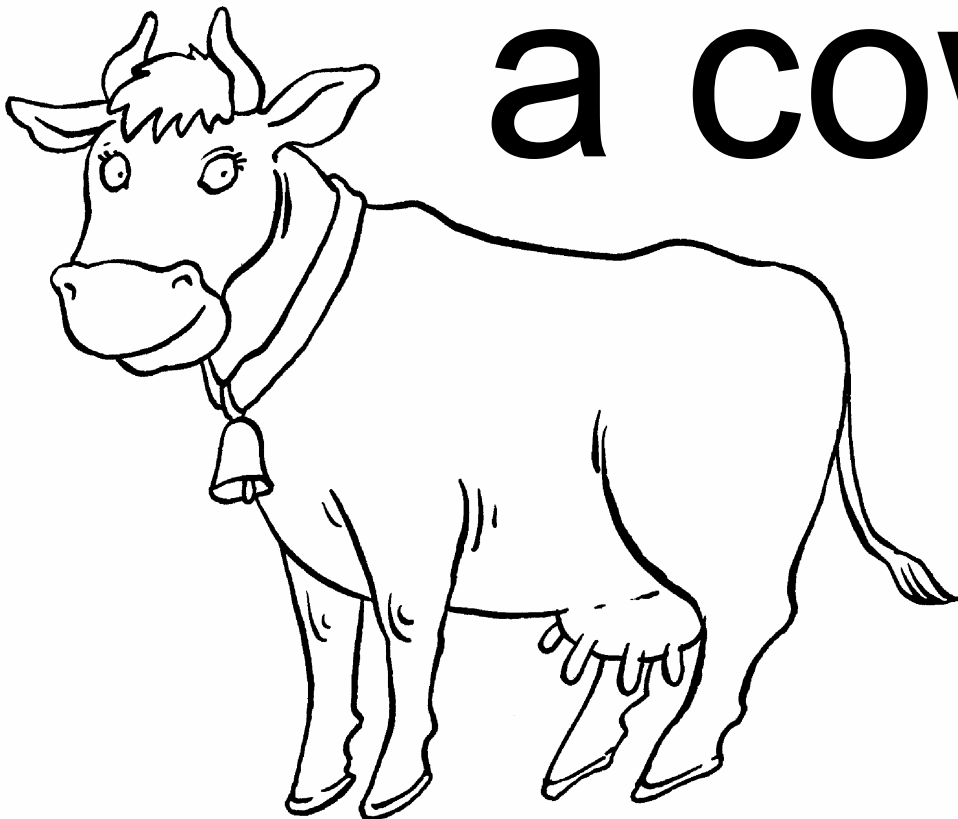

a cow

a horse

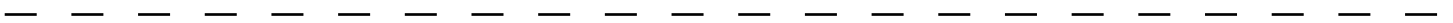

a cow

a snake

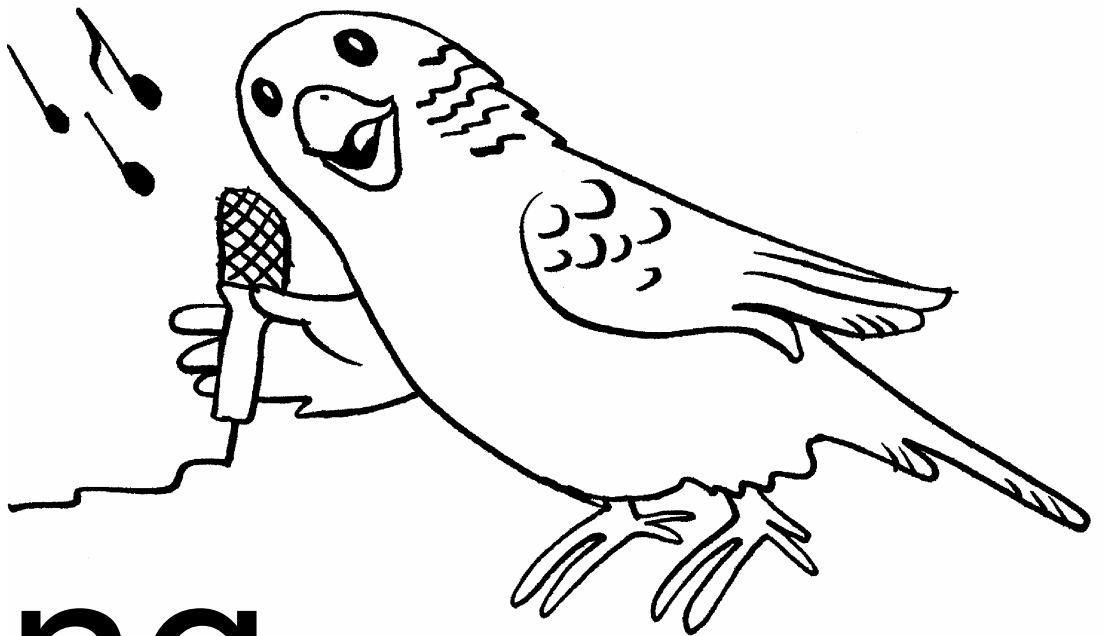
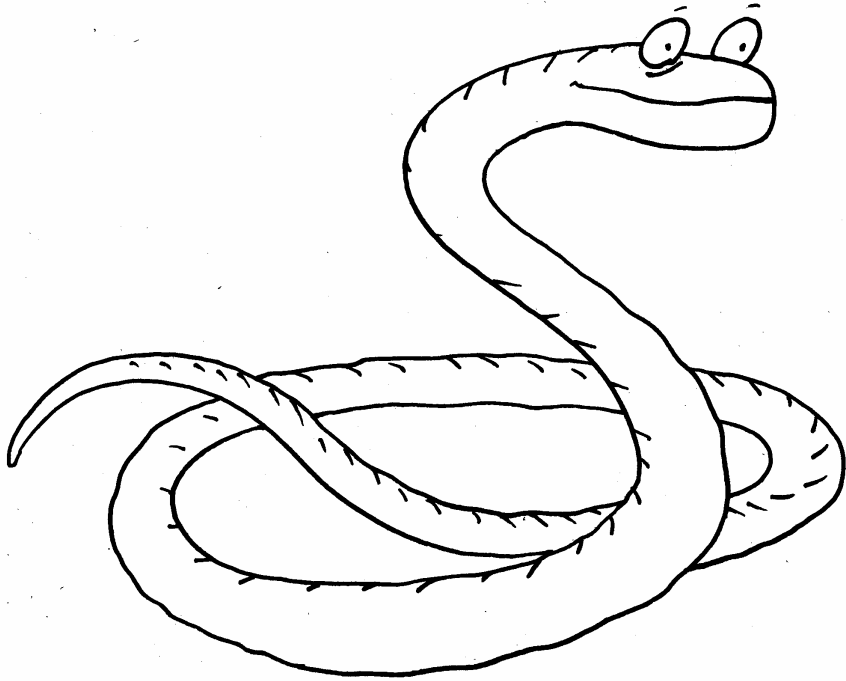

sing

a snake

sing

walk

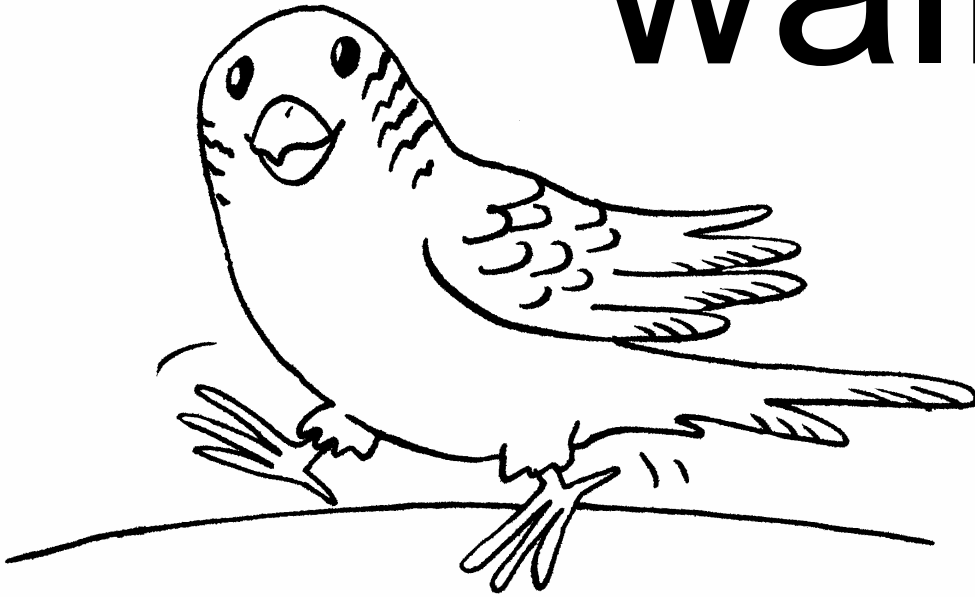

dance



walk

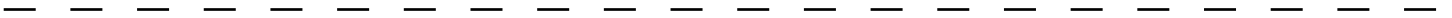

dance

run



jump

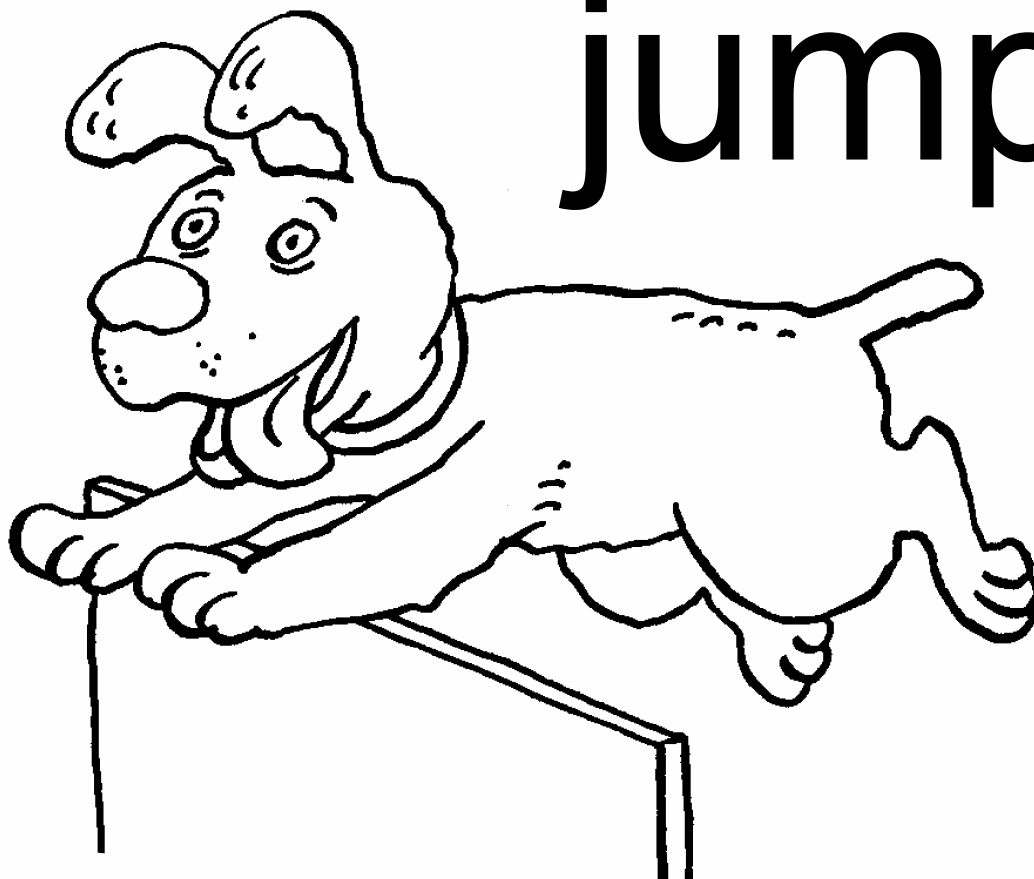

run

jump

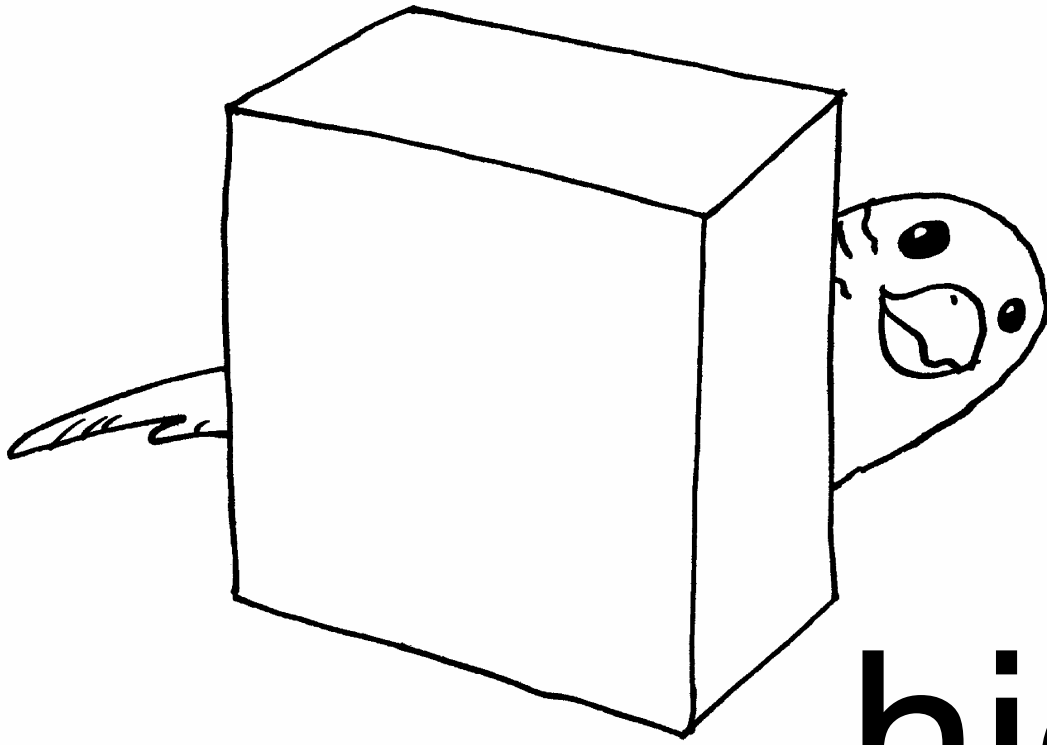

hide



fly

hide

fly

swim



go to
the circus

swim

go to
the circus



play
volleyball

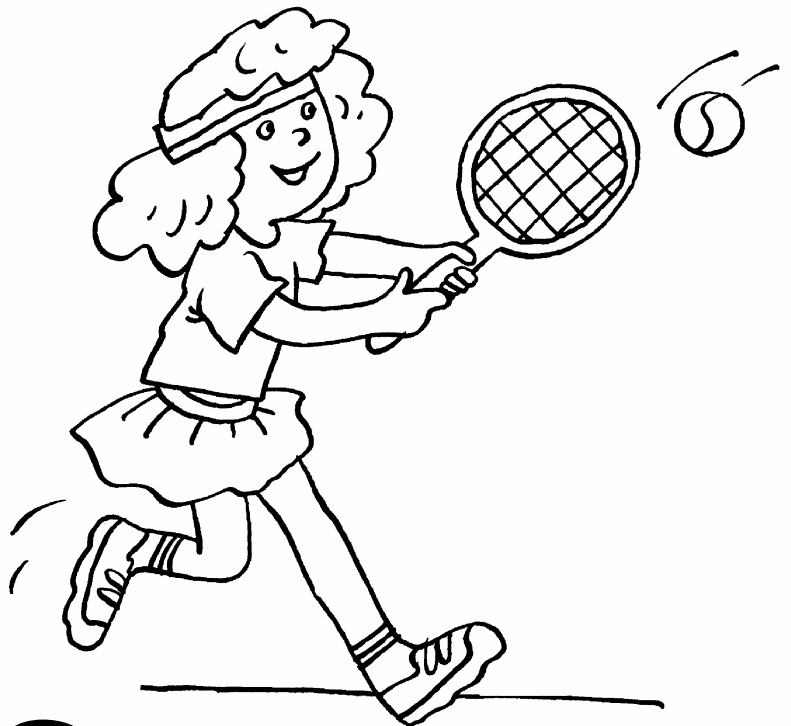

play
tennis

play

volleyball

play

tennis

ski



play
football



ski

play
football

skate



play

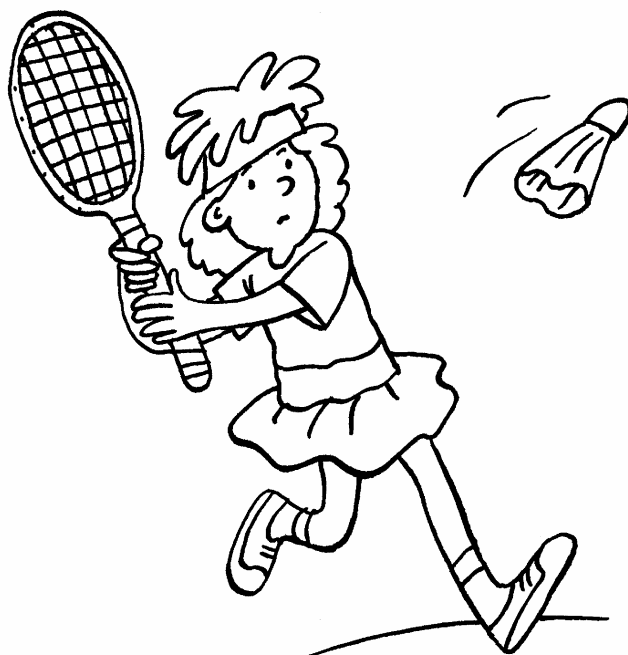

badminton

skate

play

badminton

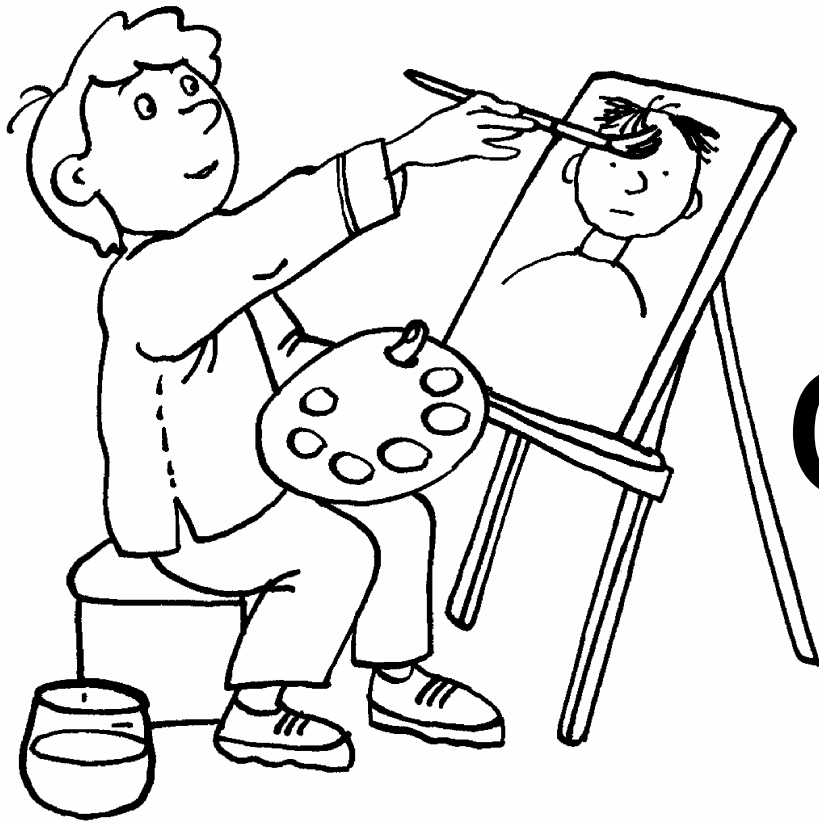

draw



do my
homework

draw

do my

homework

go to bed

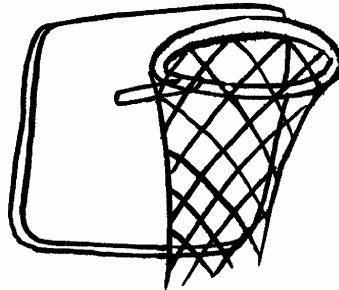

play basketball

go to bed

play

basketball

breakfast

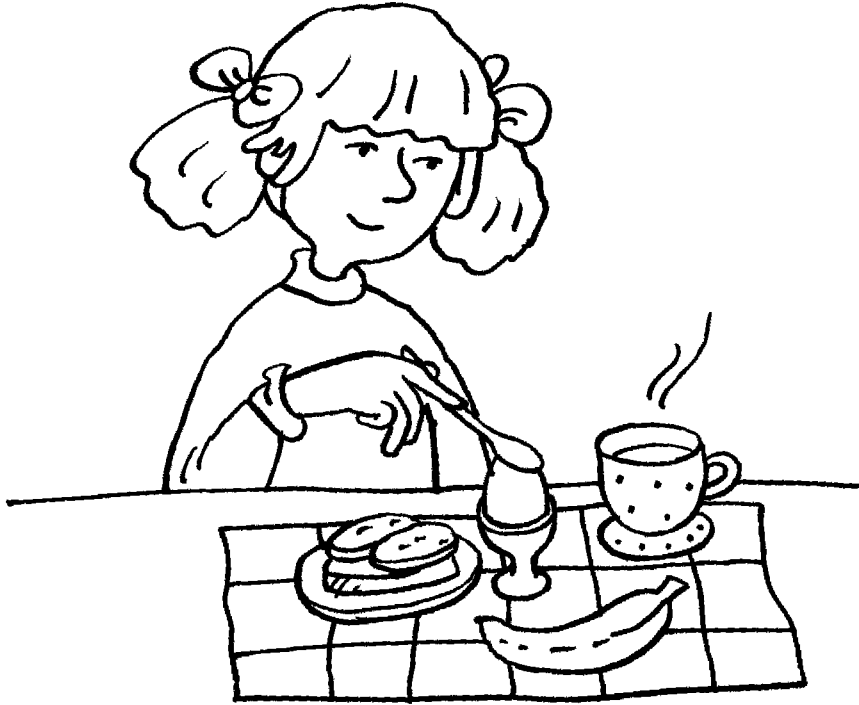

lunch



breakfast

lunch

dinner



go to school



dinner

go to
school

sleep



get up



sleep



get up

**wash
my face**



**speak
English**

wash

my face

speak

English

play

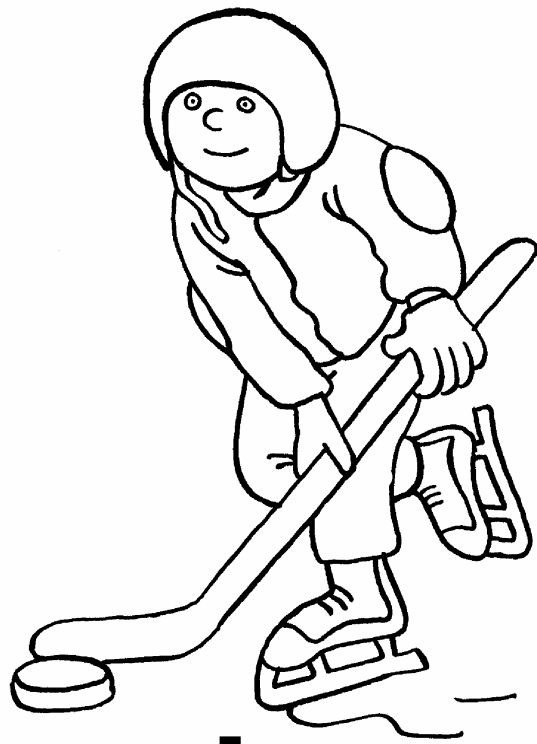

ice-hockey

take

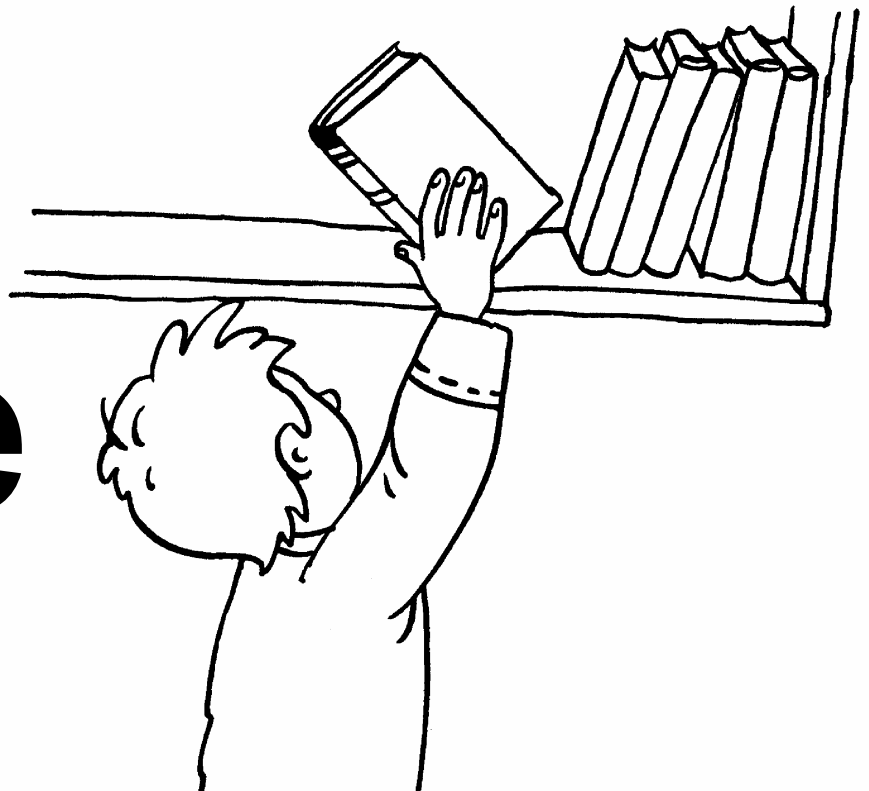

play

ice-hockey

take

brush
my teeth



brush
my hair



brush

my teeth

brush

my hair

go for a walk

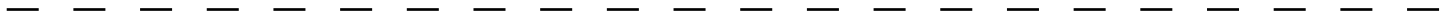

write

go for a walk

write

read a book



watch TV



read a book

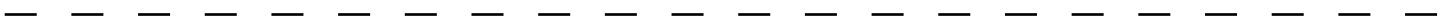

watch TV

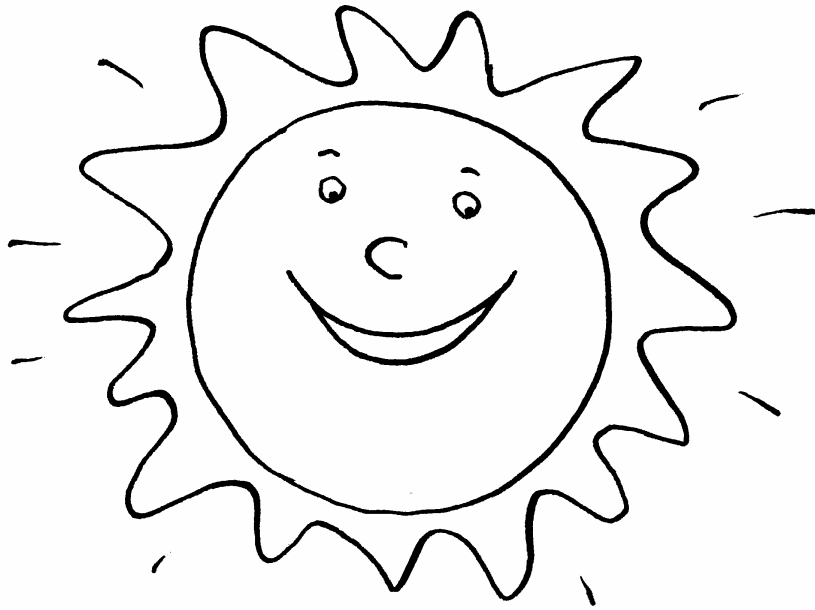

morning

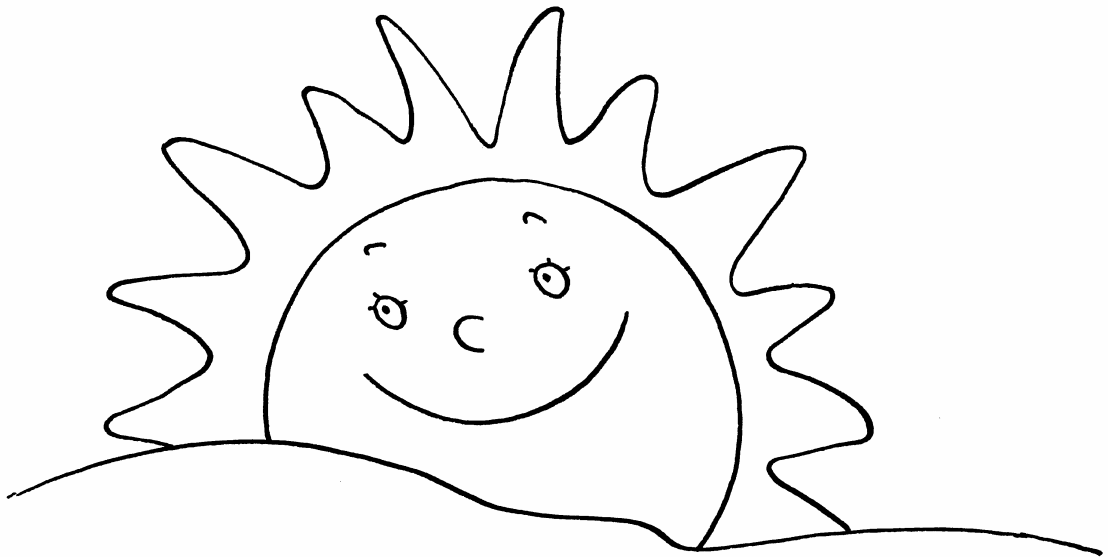

afternoon

morning

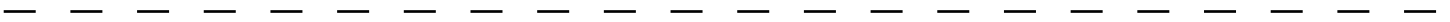

afternoon



evening

go to the zoo

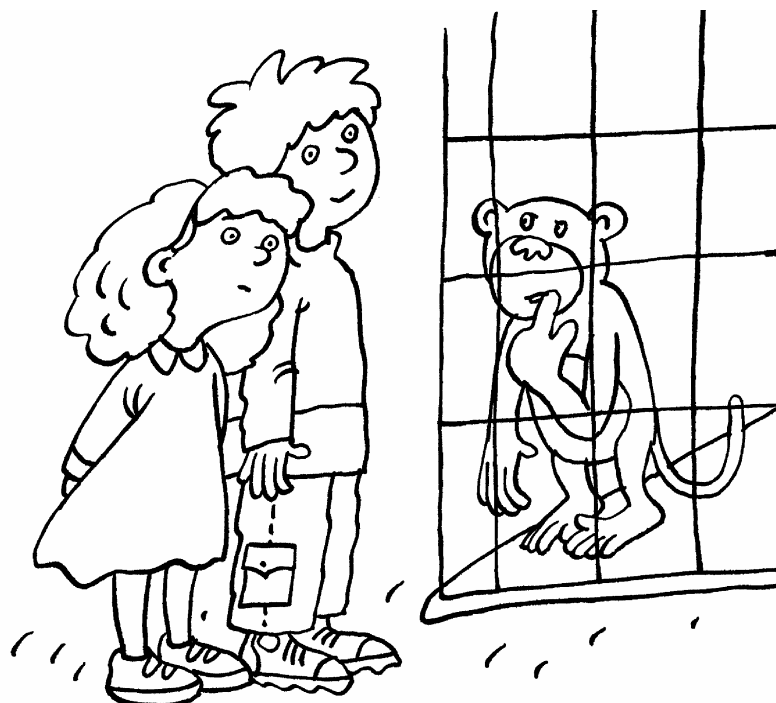

evening

go to the zoo

put



play



computer
games

put

play

computer

games

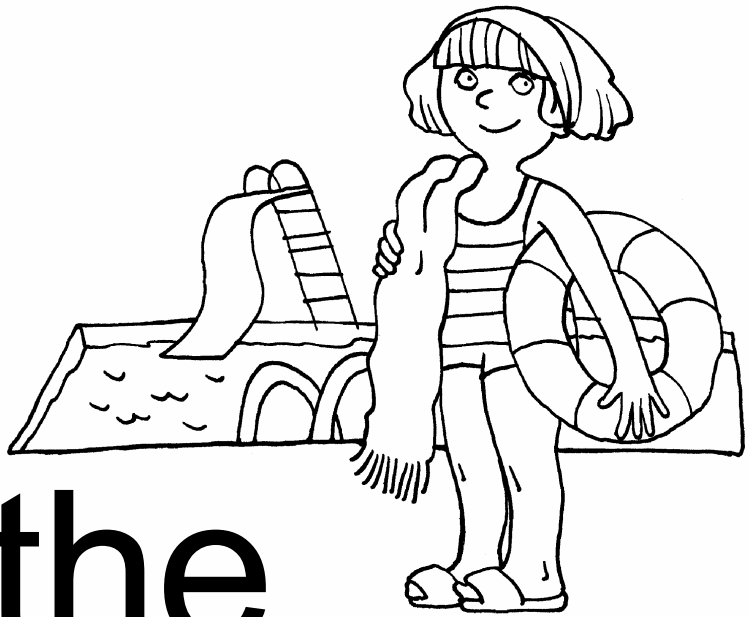

go to the
swimming-pool



listen
to music

go to the
swimming-pool

listen
to music

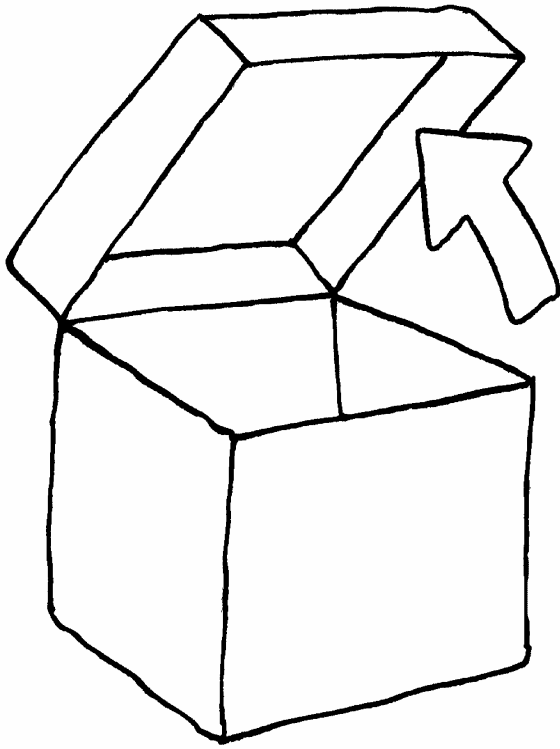

open

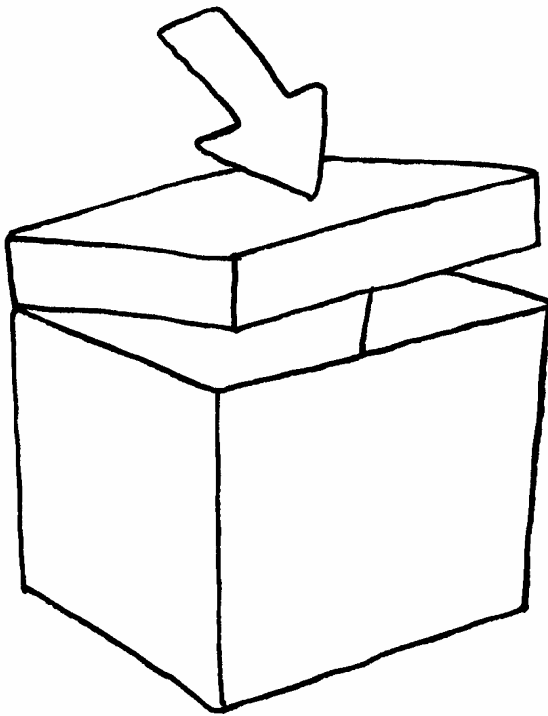

close

open

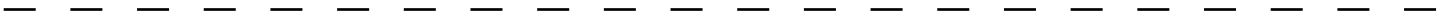

close



sit down



stand up



sit down

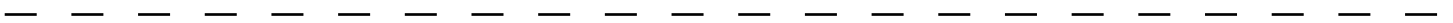

stand up

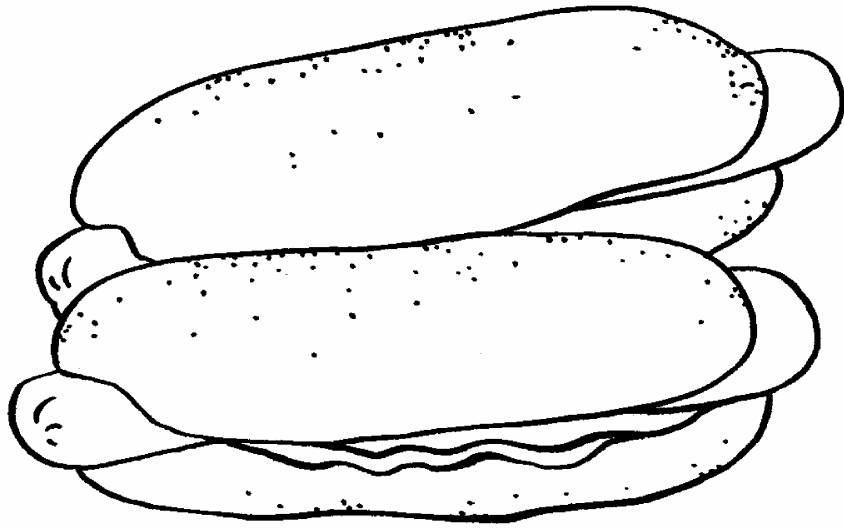

hot dogs

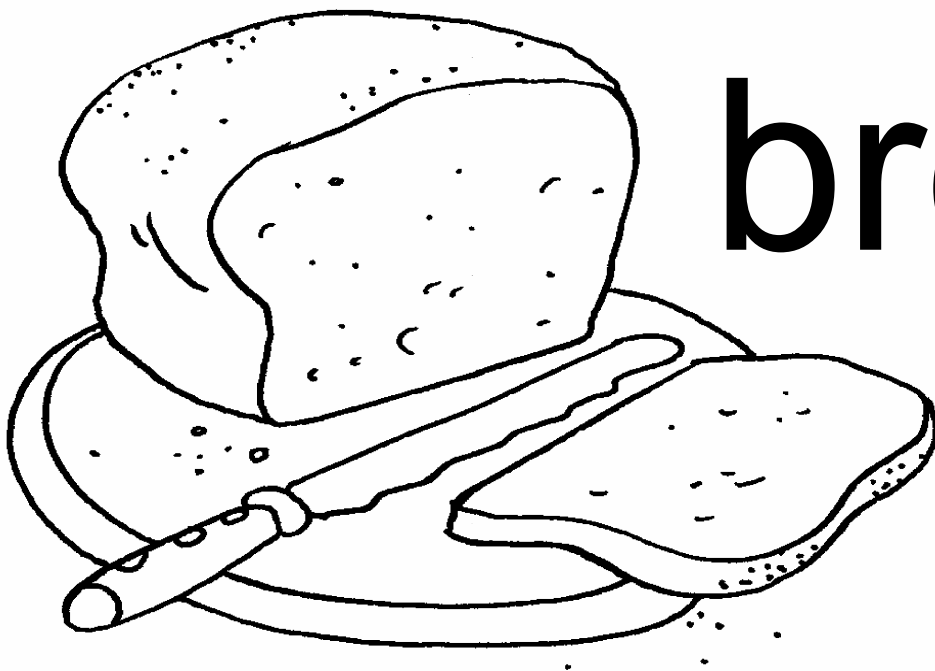

bread

hot dogs

bread

fish

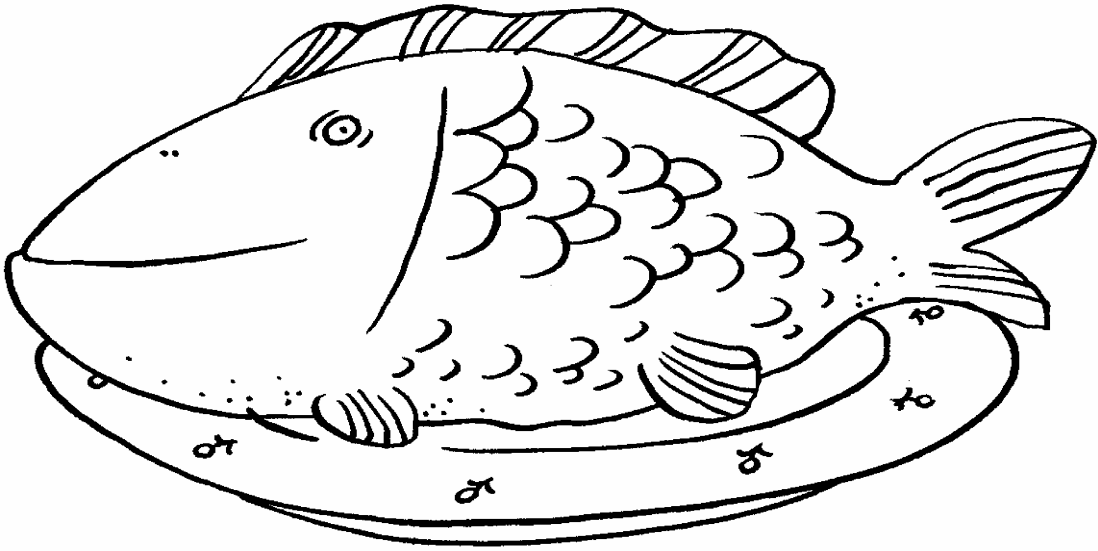

yoghurt

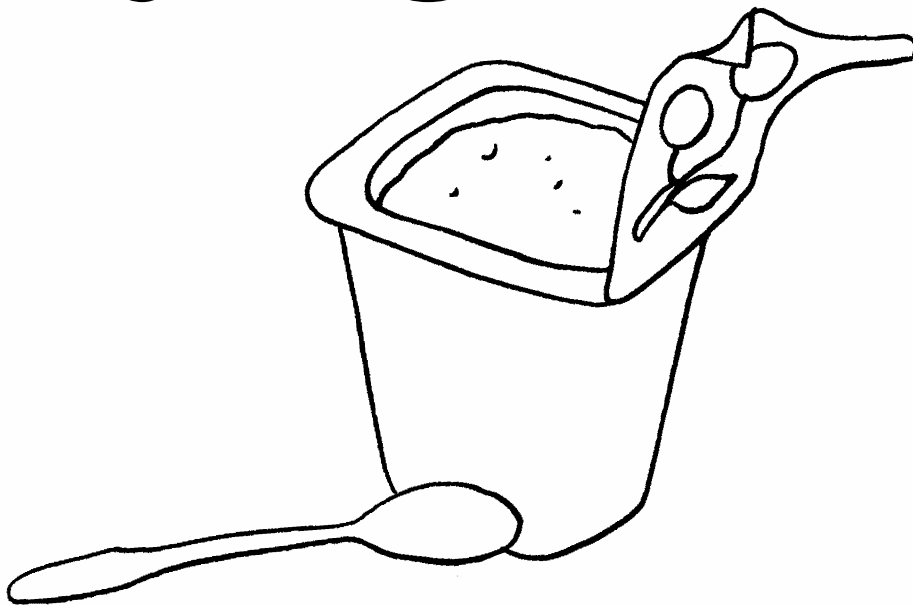

fish

yoghurt

pizza

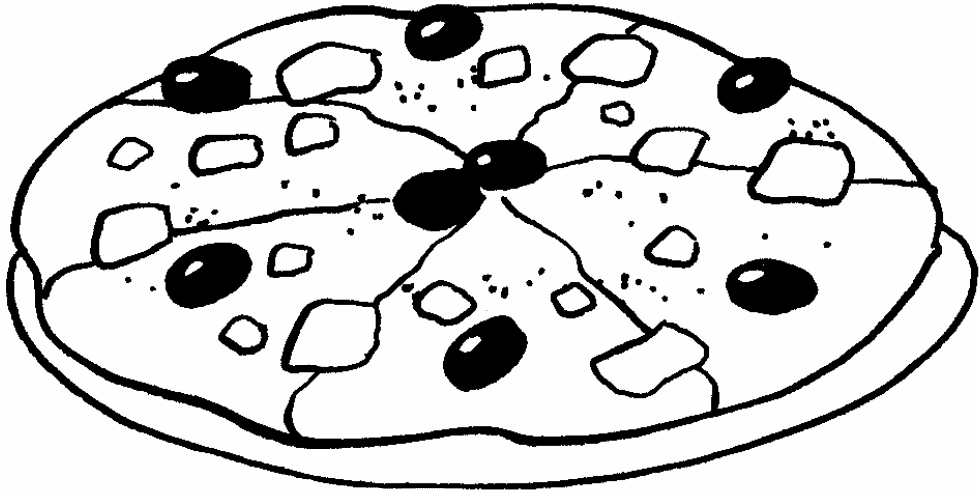

cake

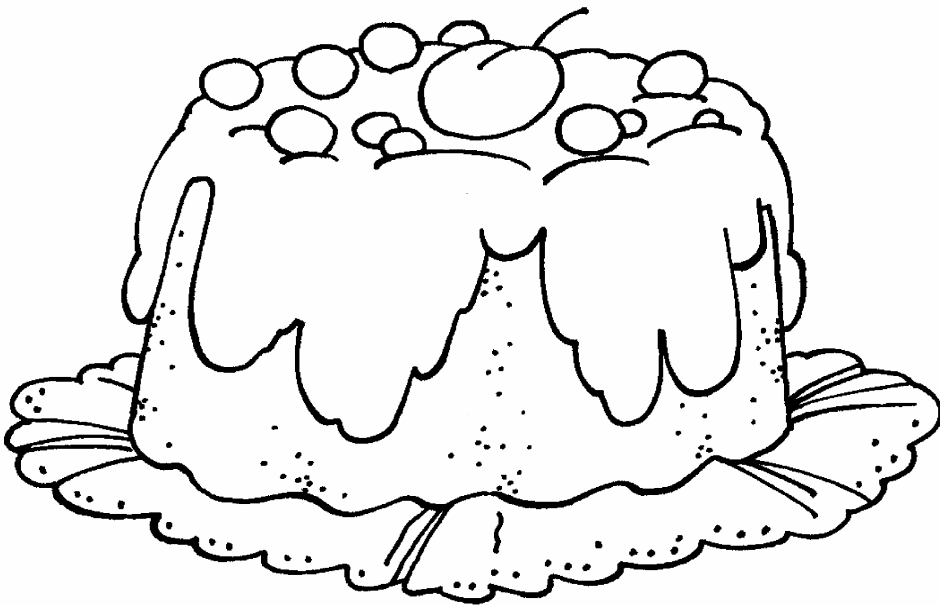

pizza

cake

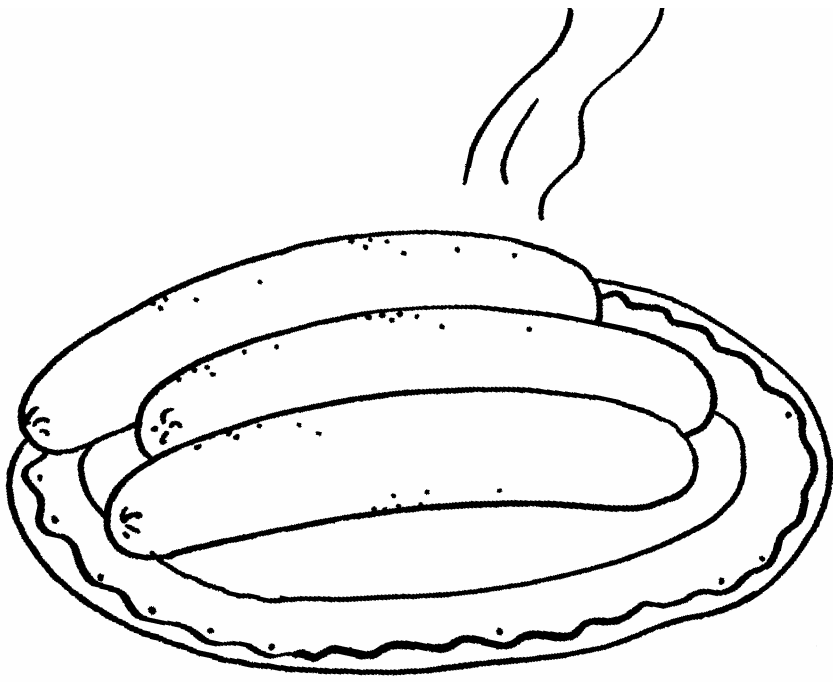

sausages

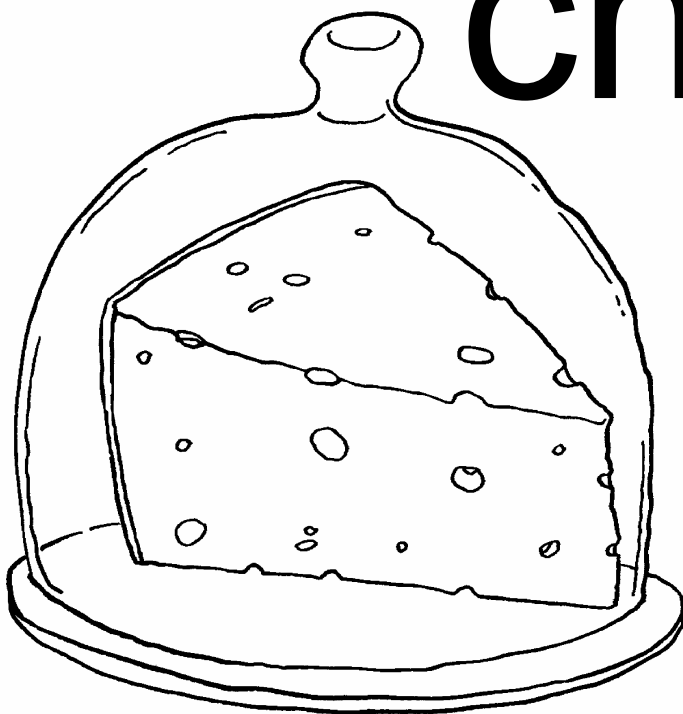

cheese

sausages

cheese

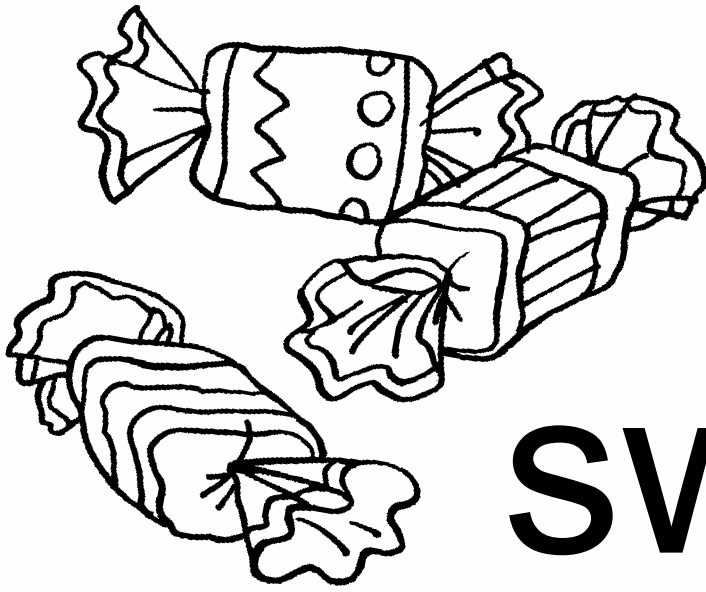

sweets

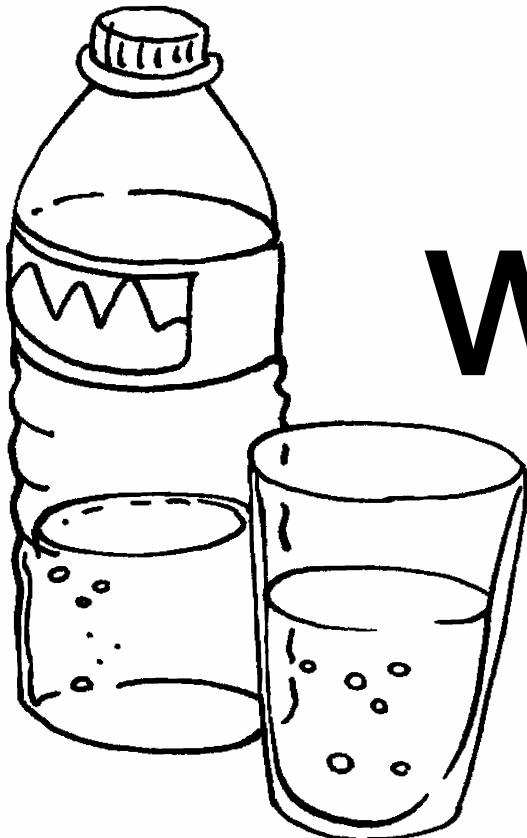

water

sweets



water

eggs

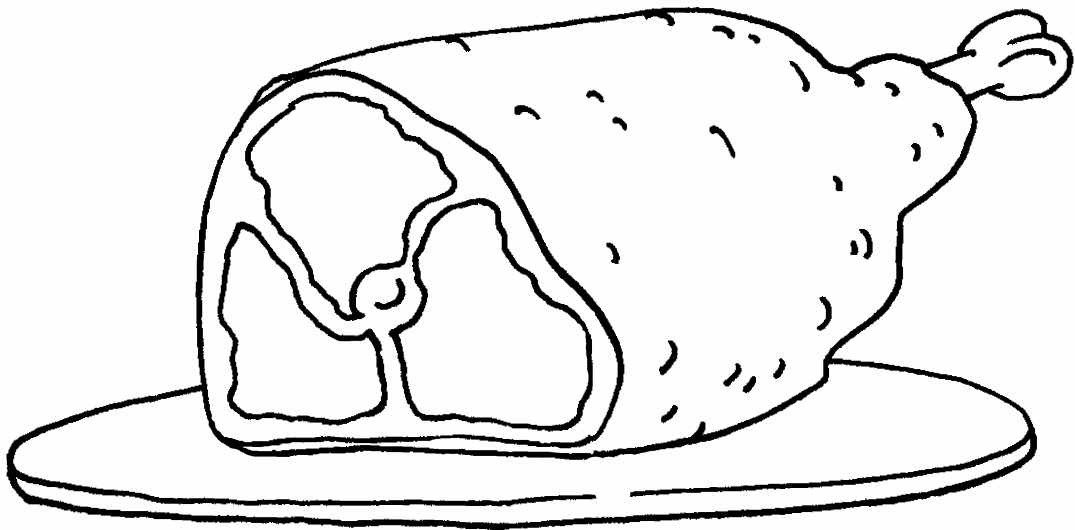
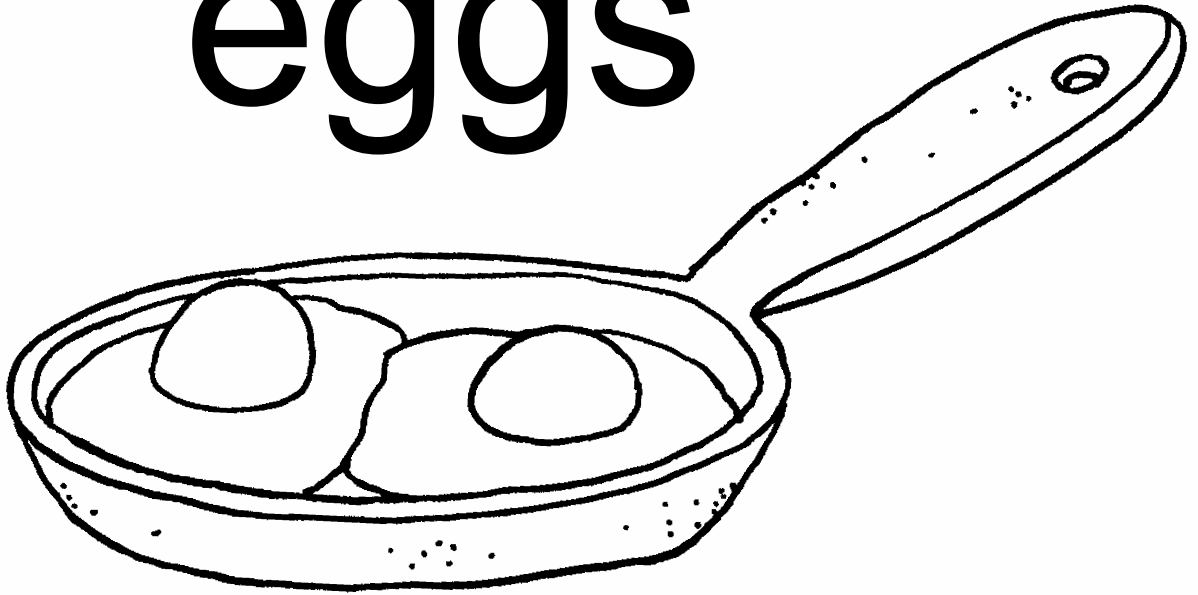

meat

eggs



meat

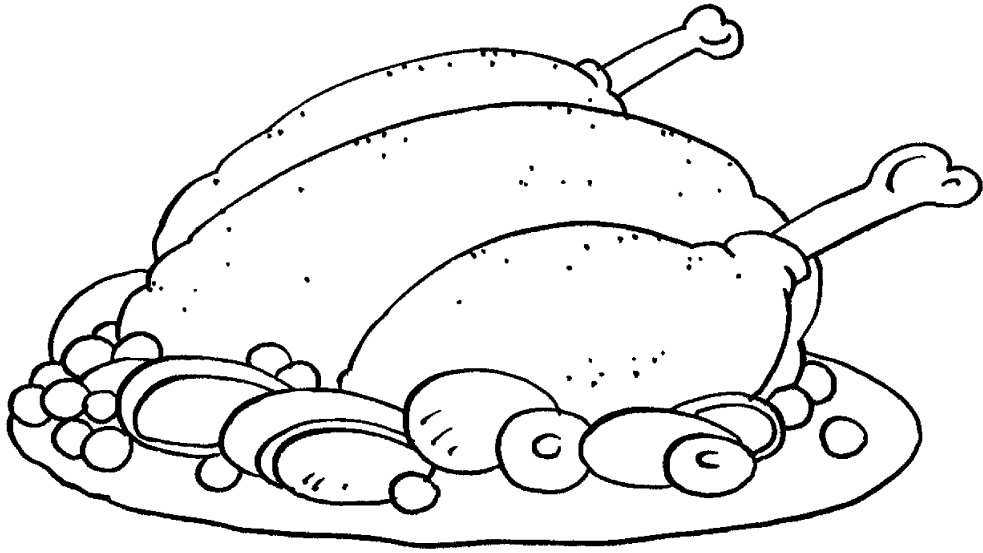

chicken

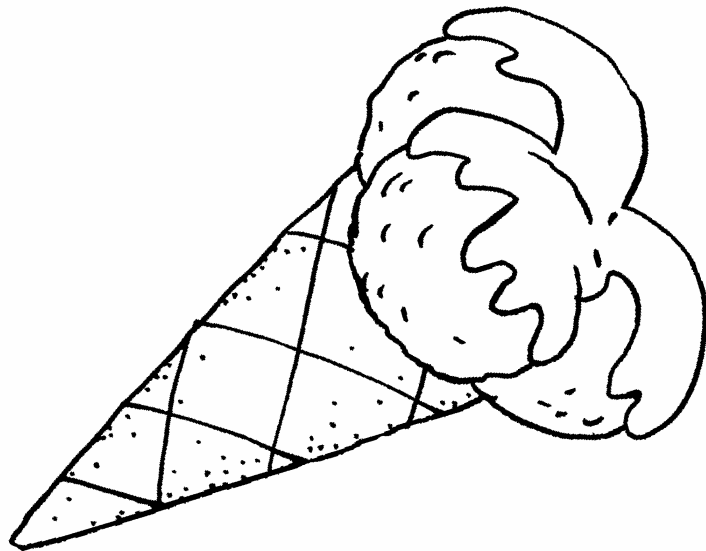

ice-cream

chicken

ice-cream

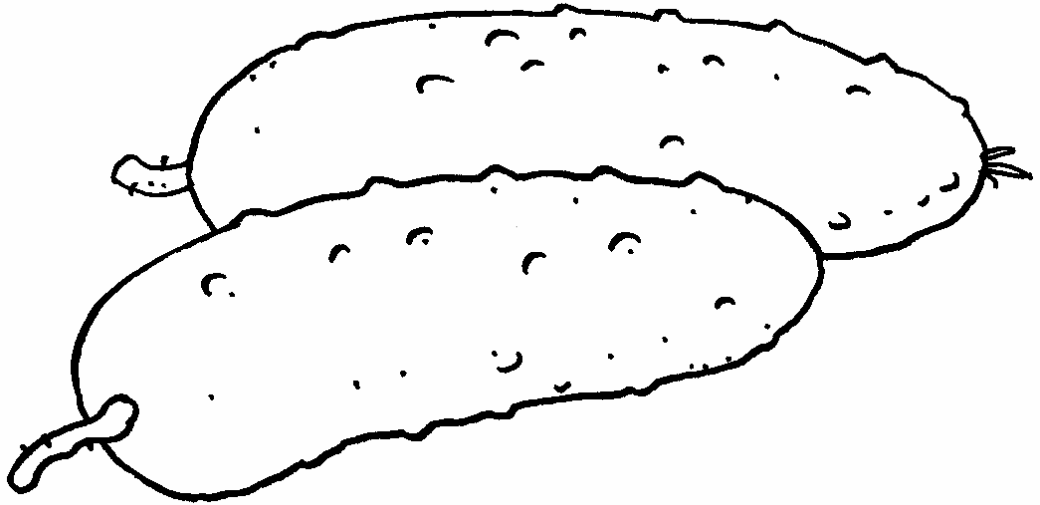

cucumbers

apples

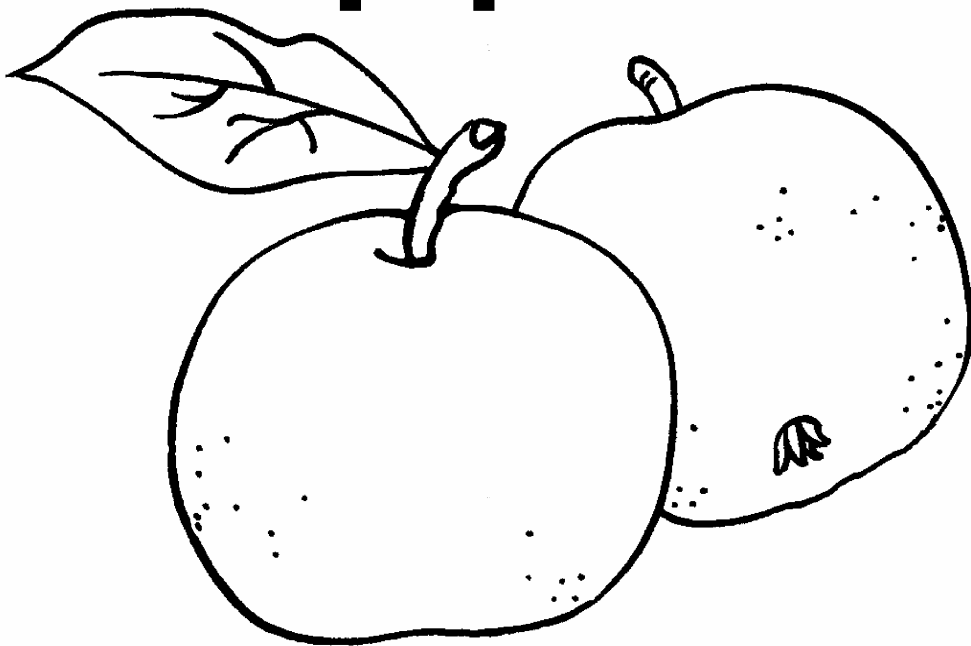

cucumbers

apples

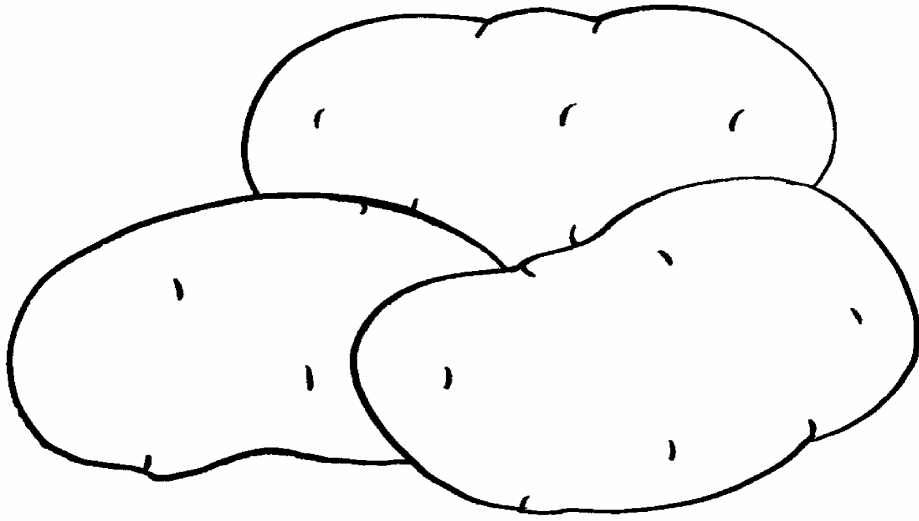

potatoes

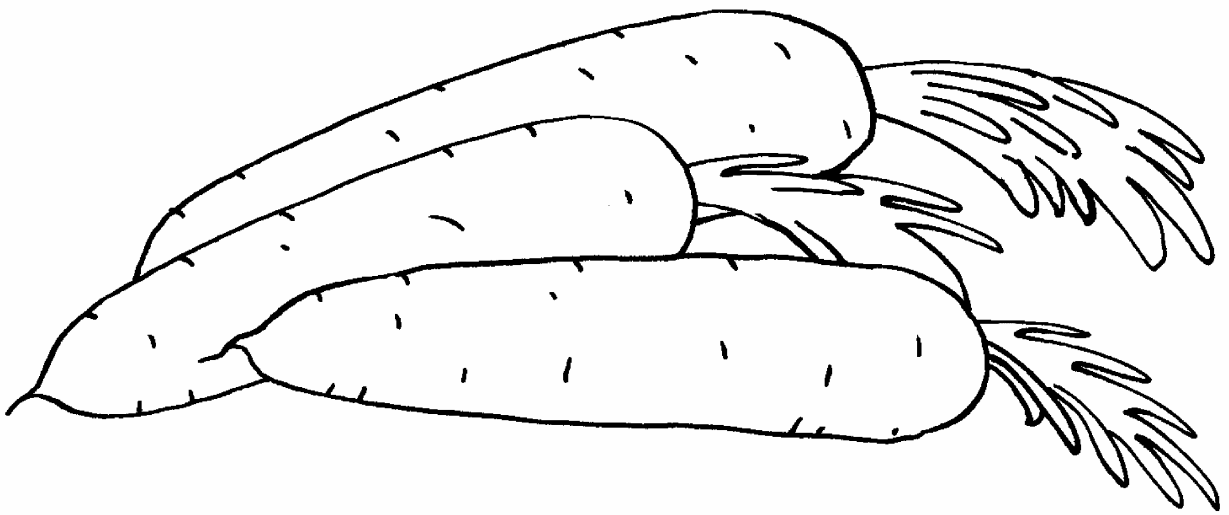

carrots

potatoes

carrots

juice

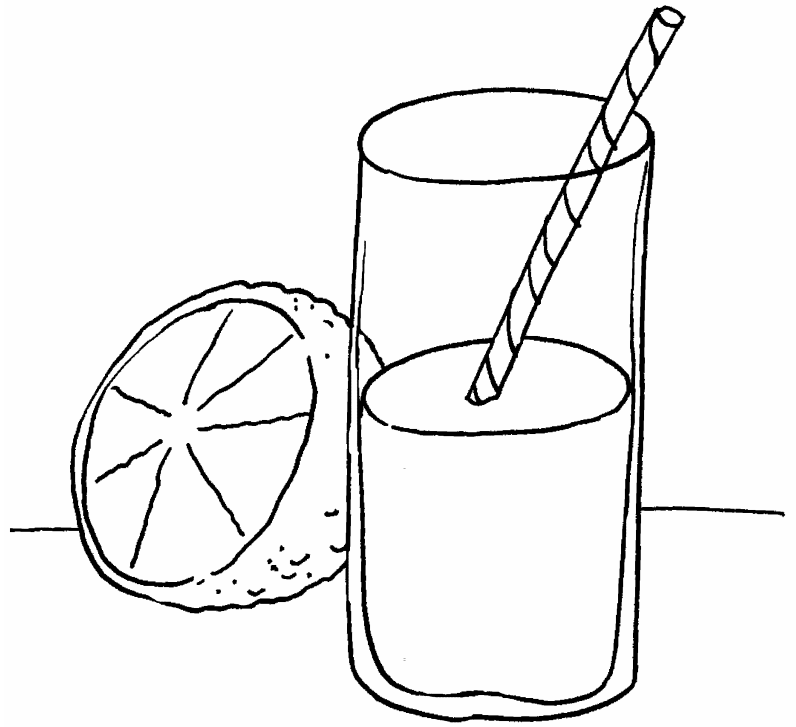

lemons

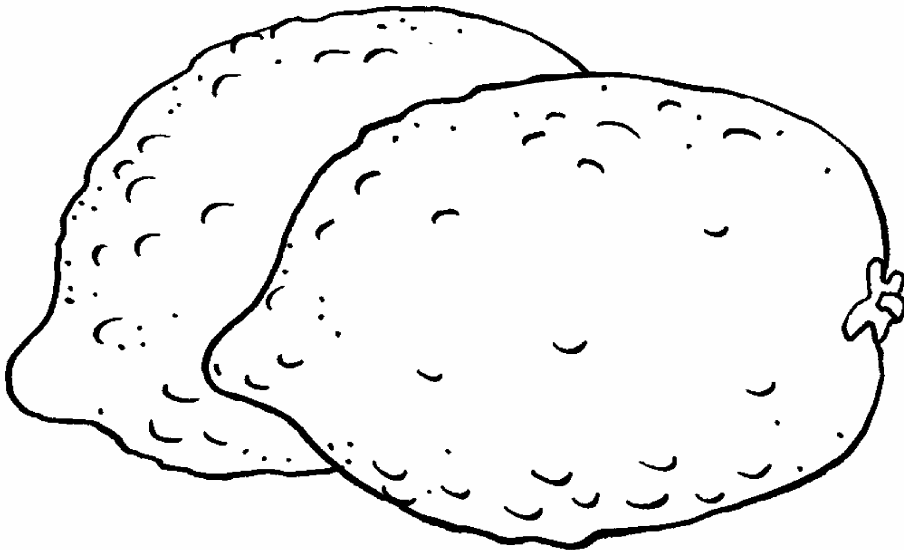

juice

lemons



jam

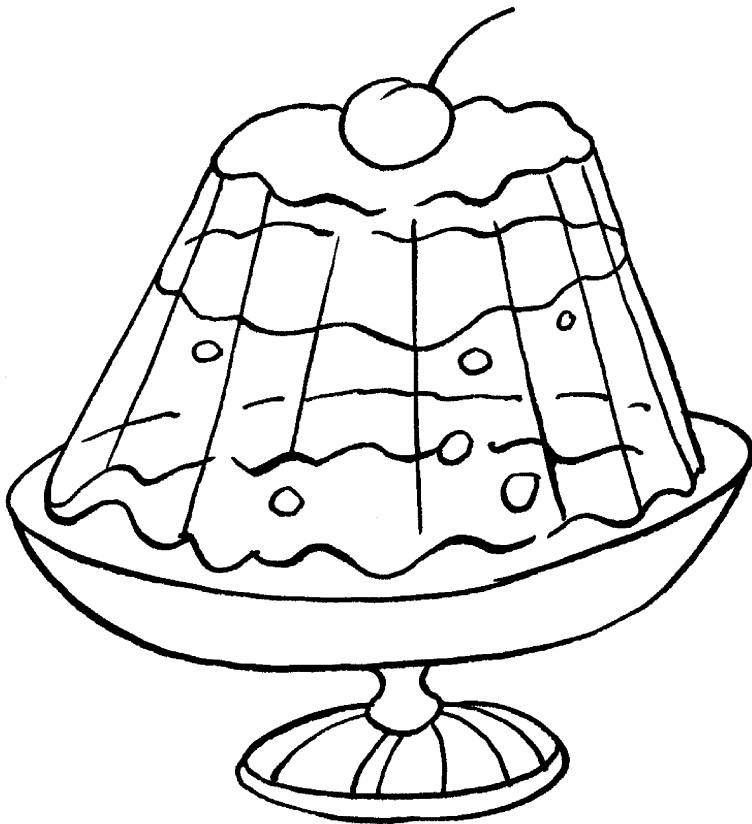

jelly

jam

jelly



coffee

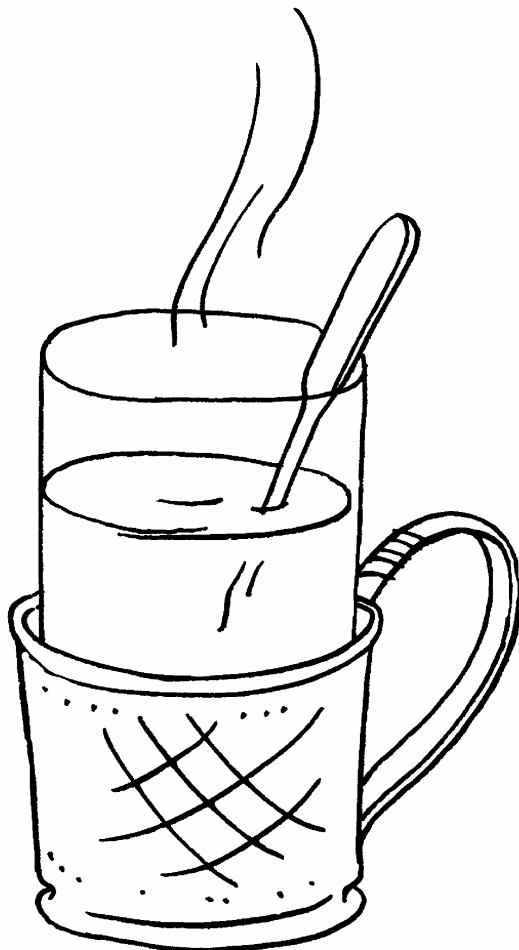

tea

coffee

tea



milk

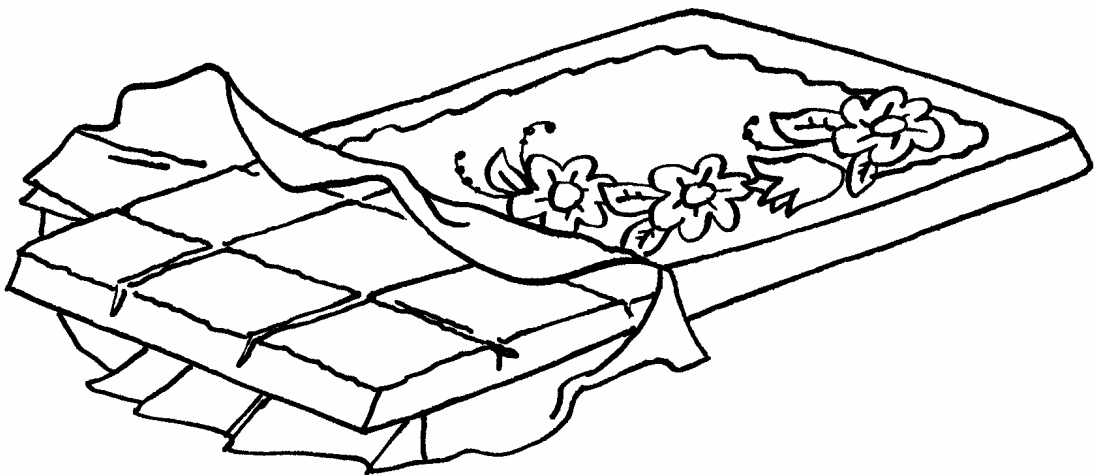

chocolate

milk

chocolate



tomatoes

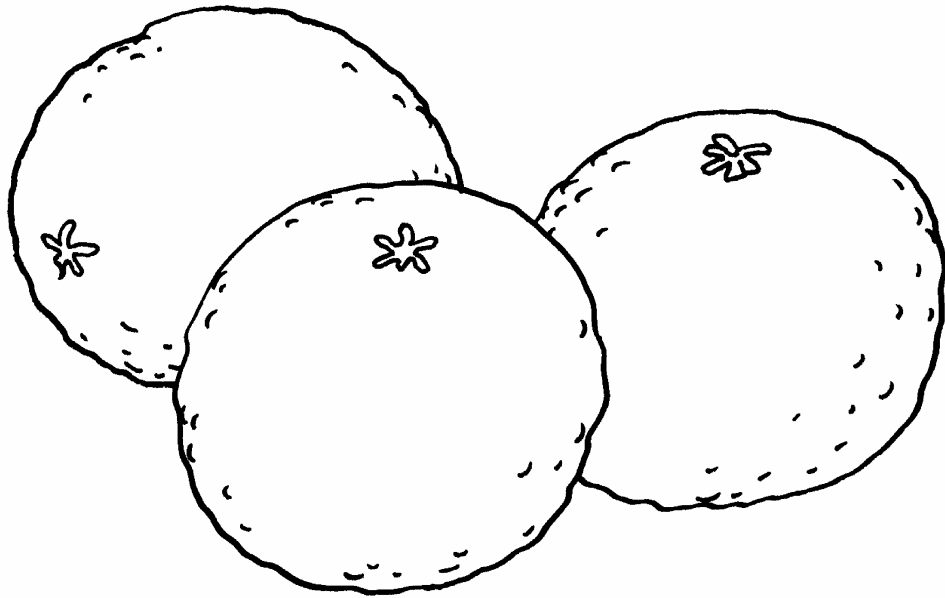

oranges

tomatoes

oranges

soup

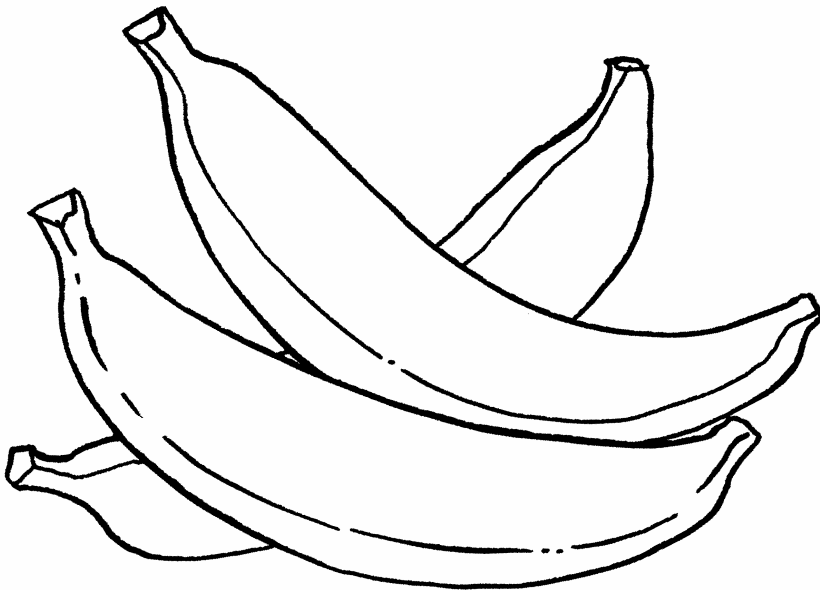
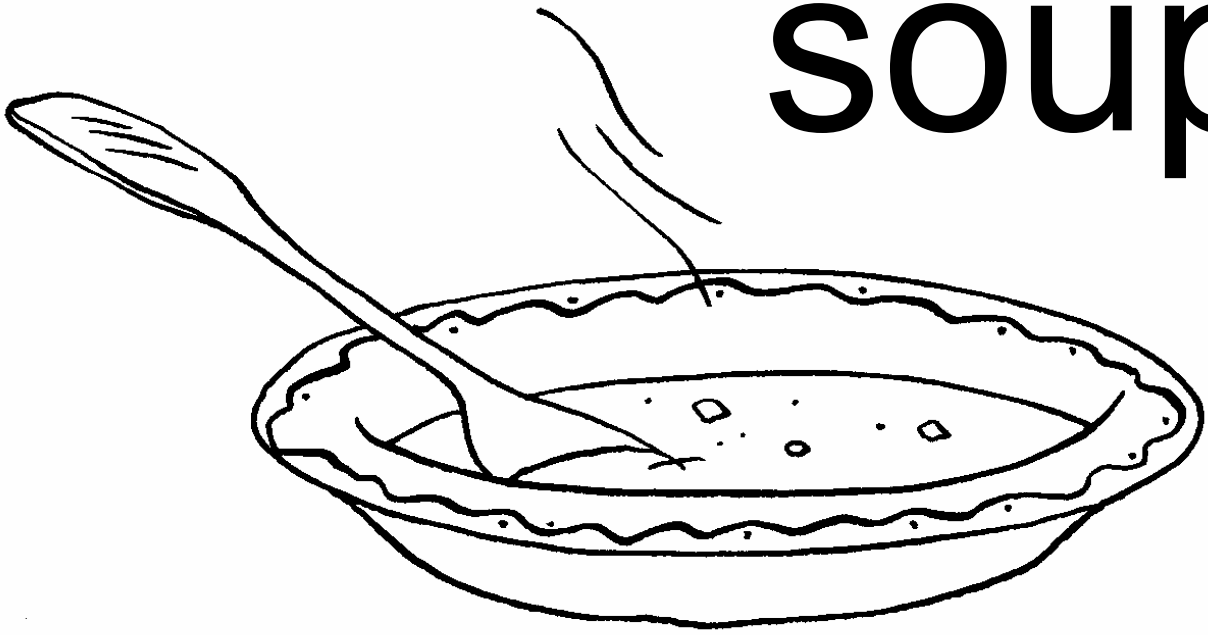

bananas

soup

bananas

drink



eat

drink

eat

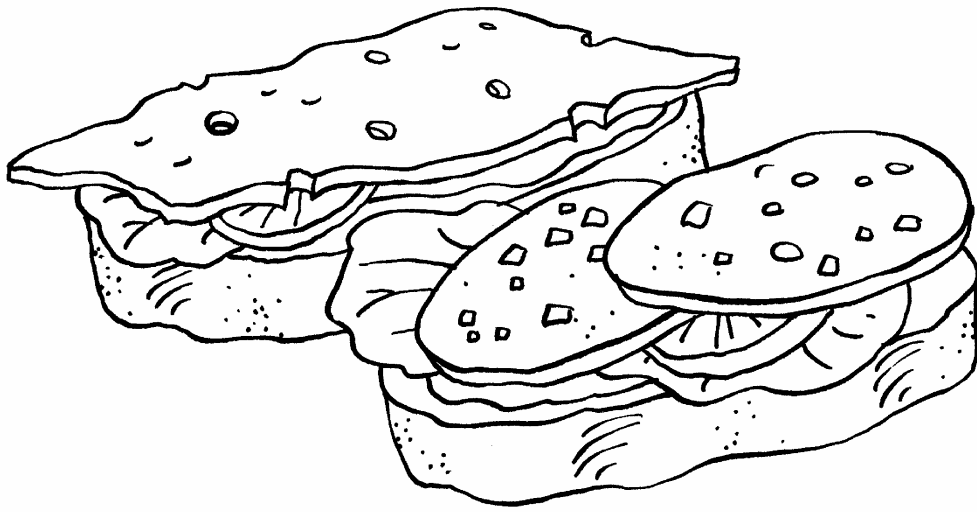

sandwiches

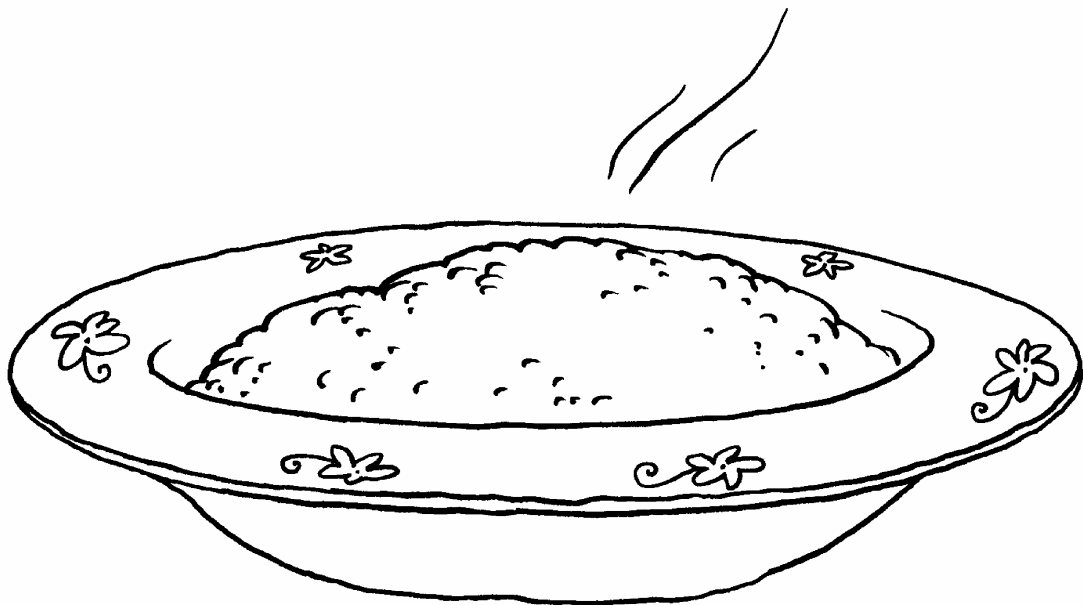

porridge

sandwiches

porridge

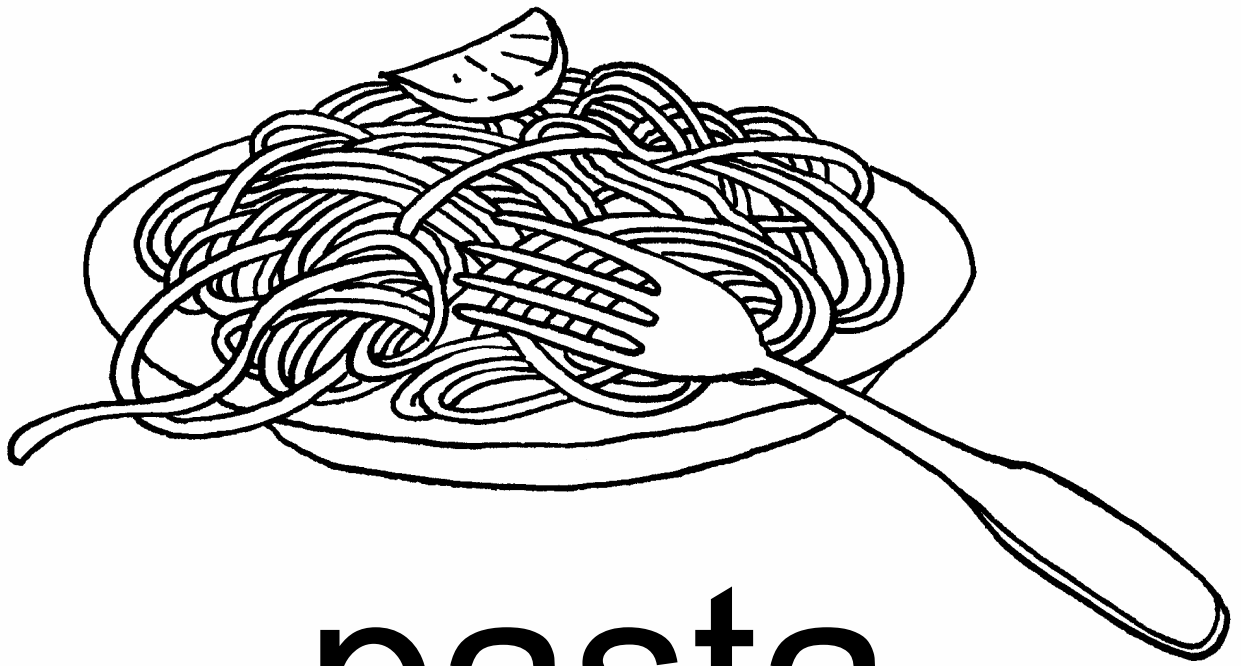

pasta

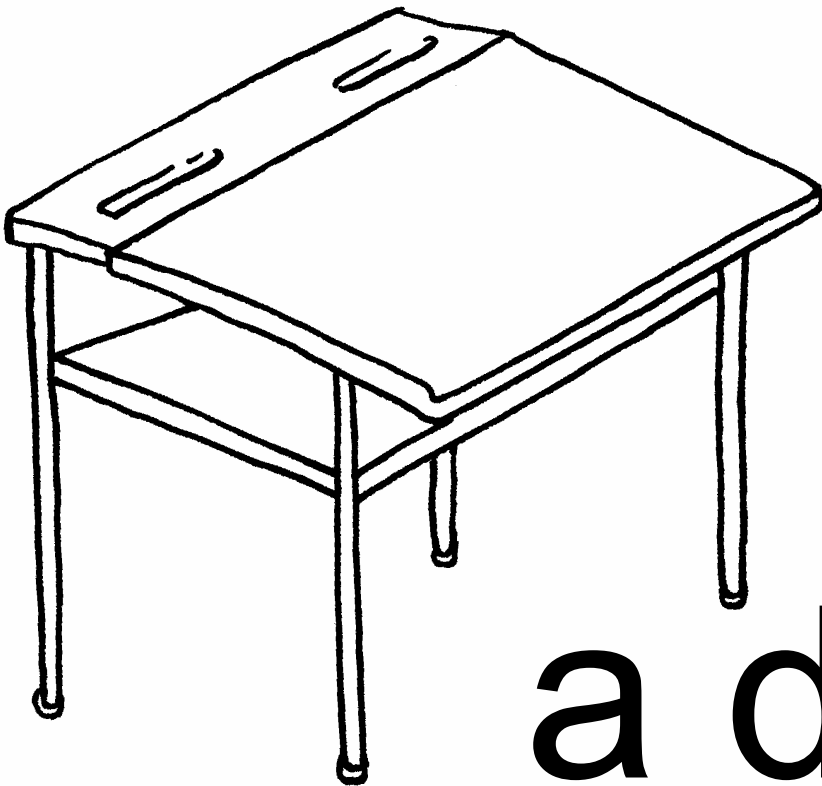

a desk

pasta

a desk

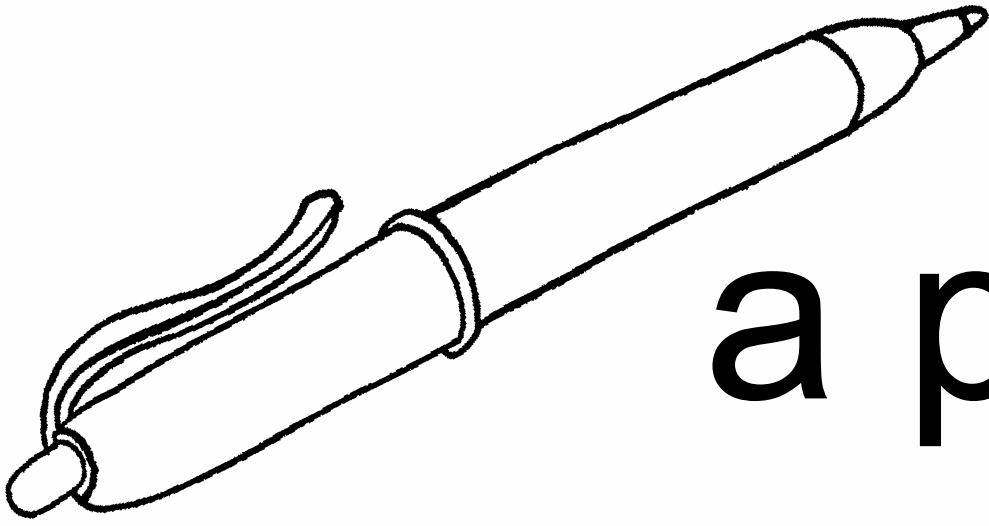

a pen

a pencil



a pen



a pencil

a book

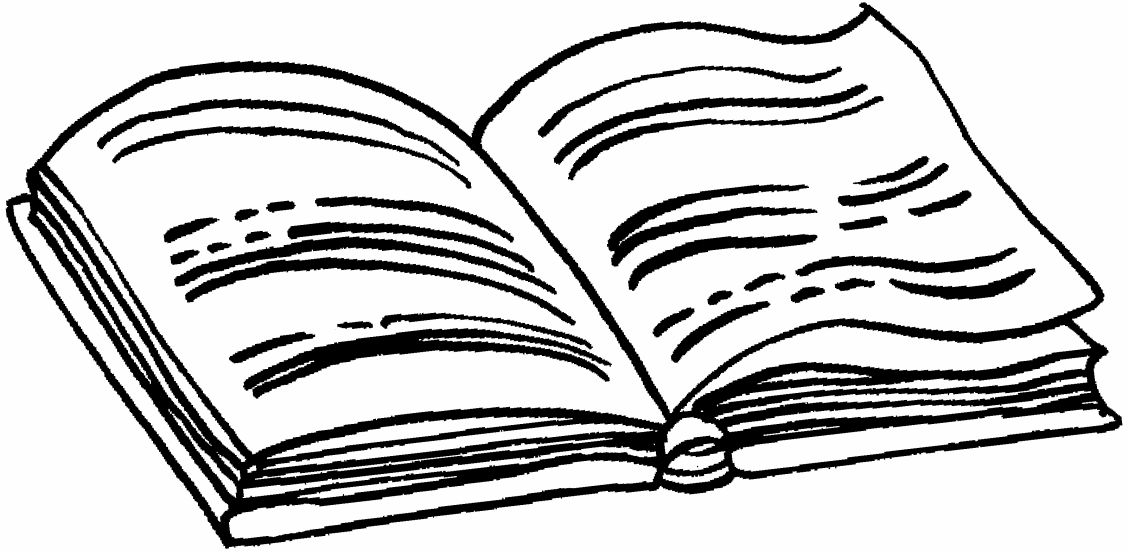

a pencil-case

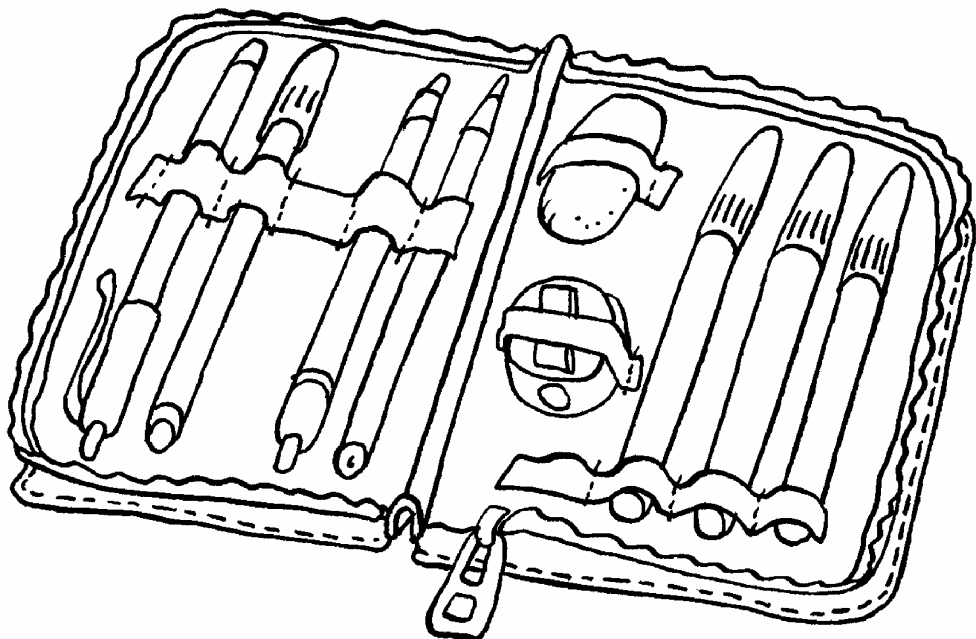

a book

a pencil-case

a ruler

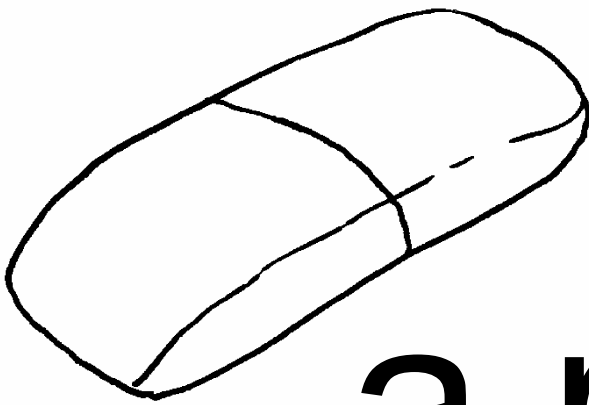
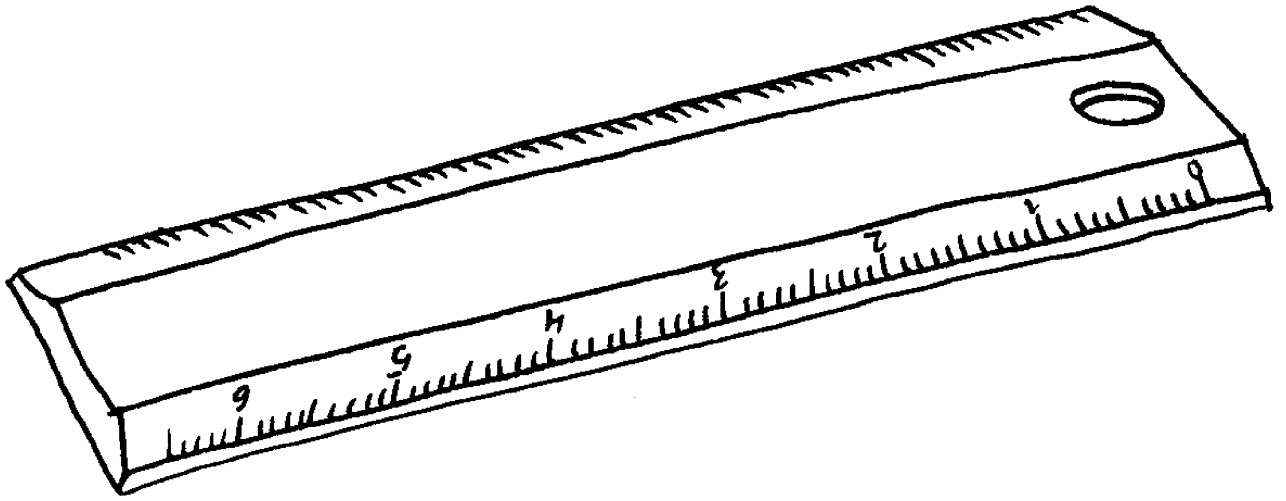

a rubber

a ruler

a rubber

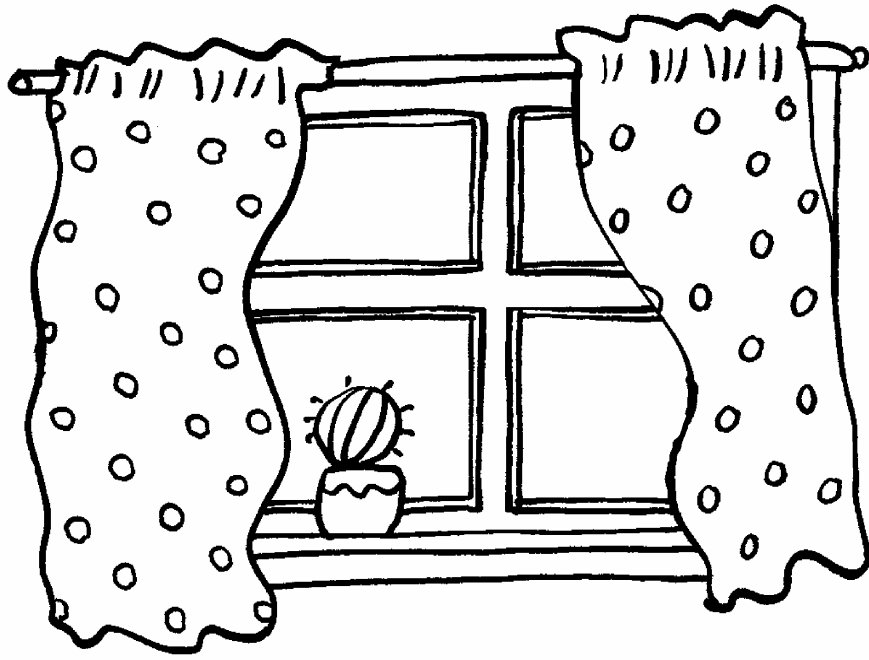

a window

the floor

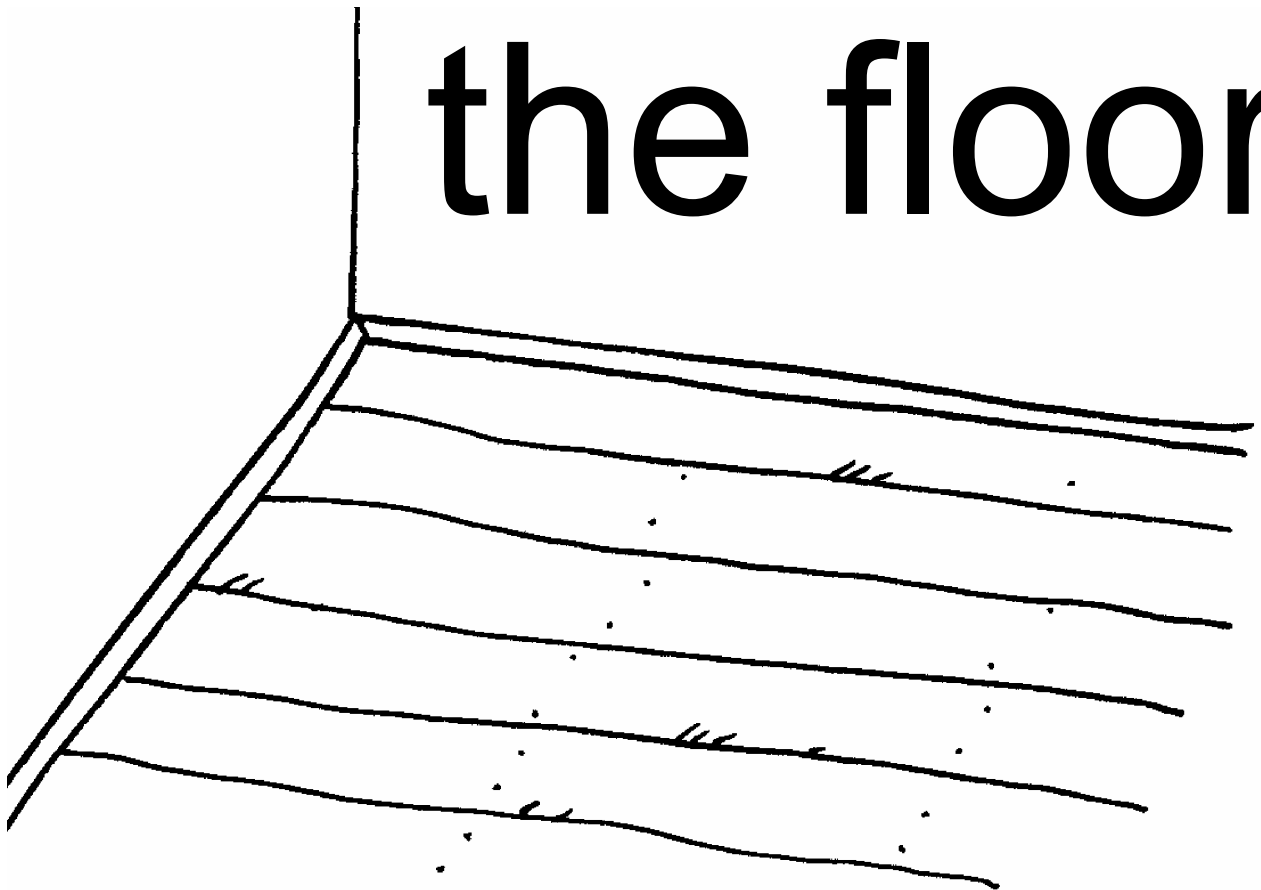

a window

the floor



a bag

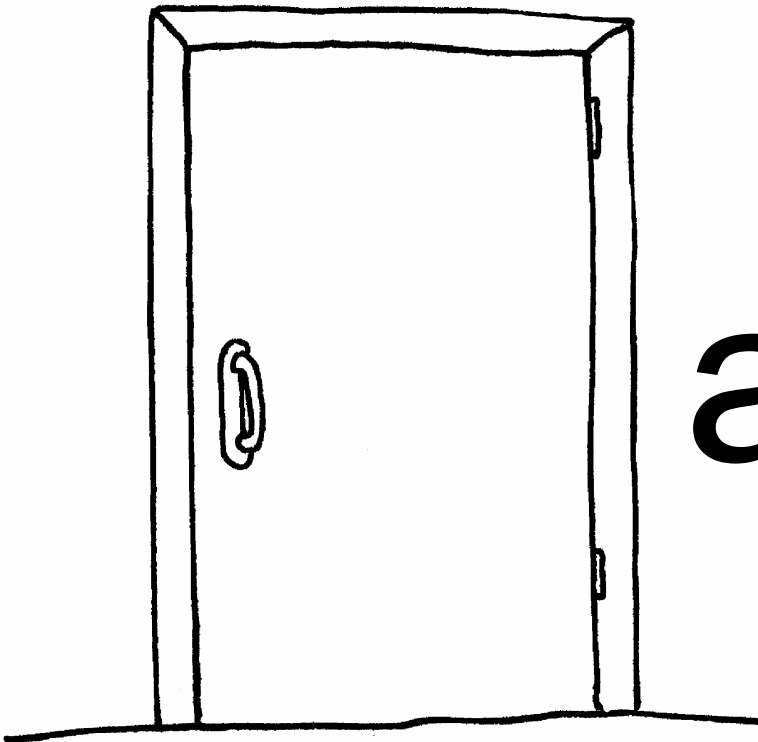

a door

a bag

a door

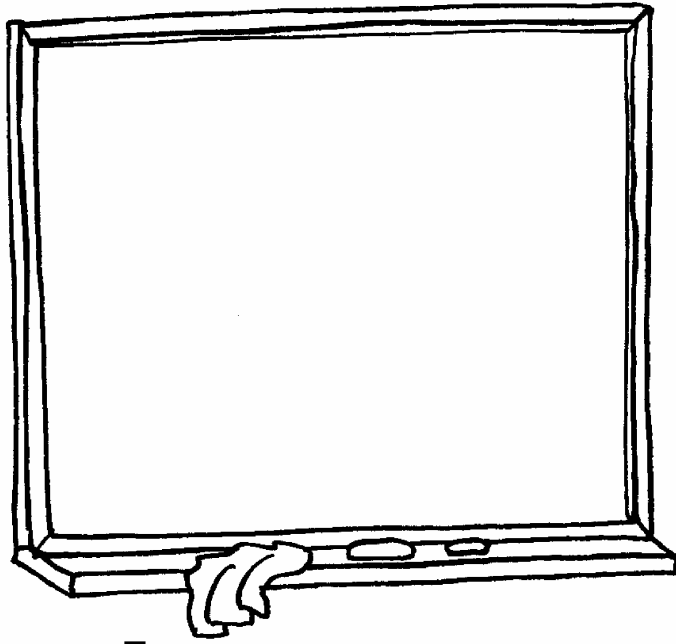

a board

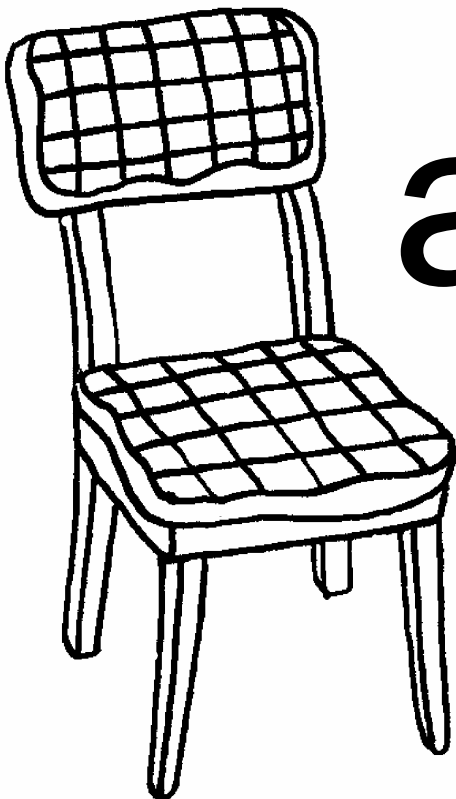

a chair

a board

a chair

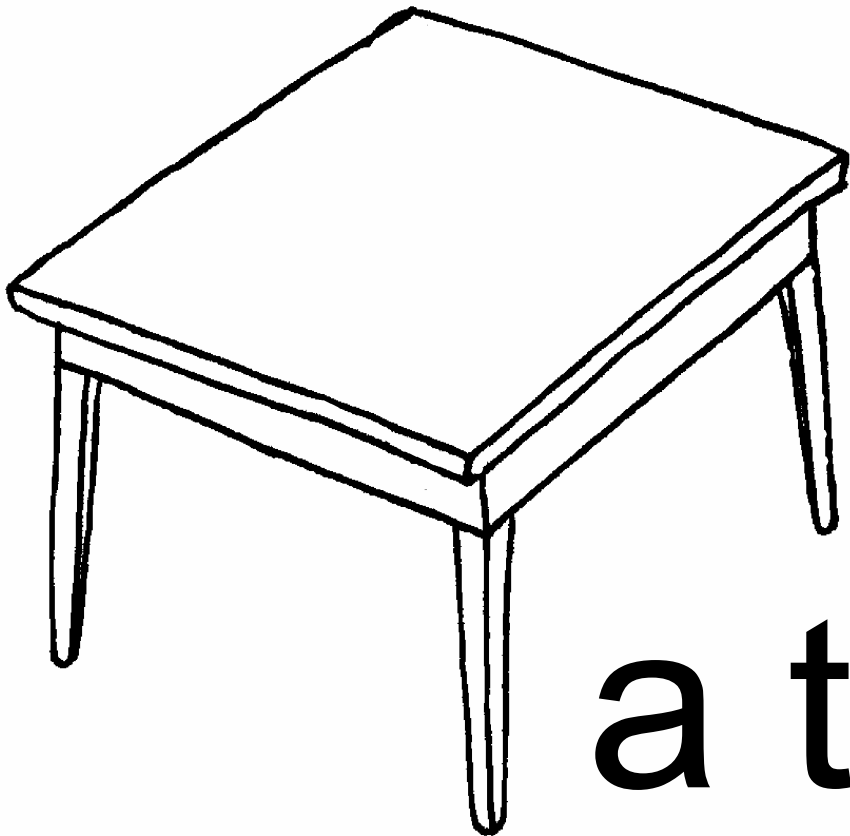

a table

a bookcase

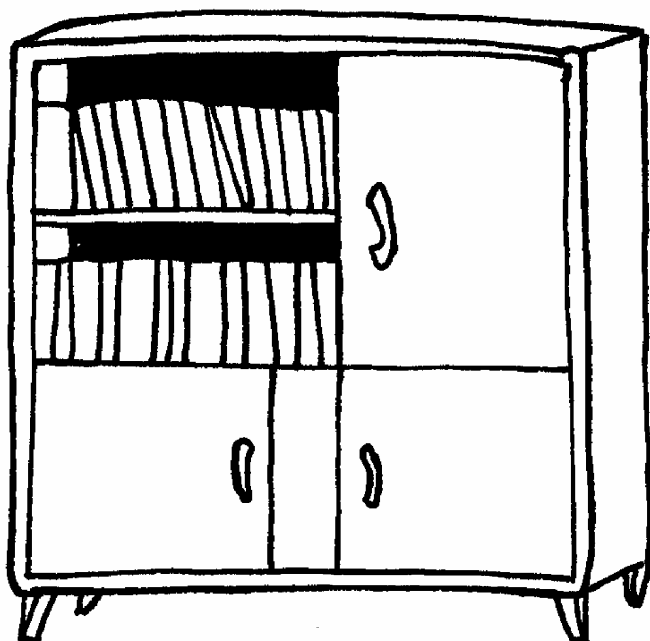

a table

a bookcase

near

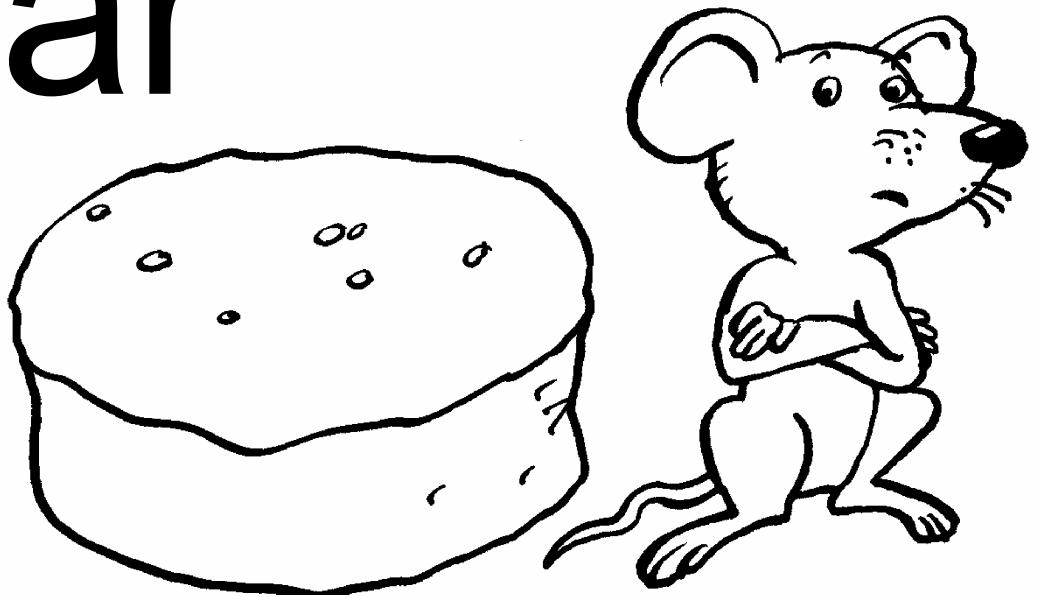

behind

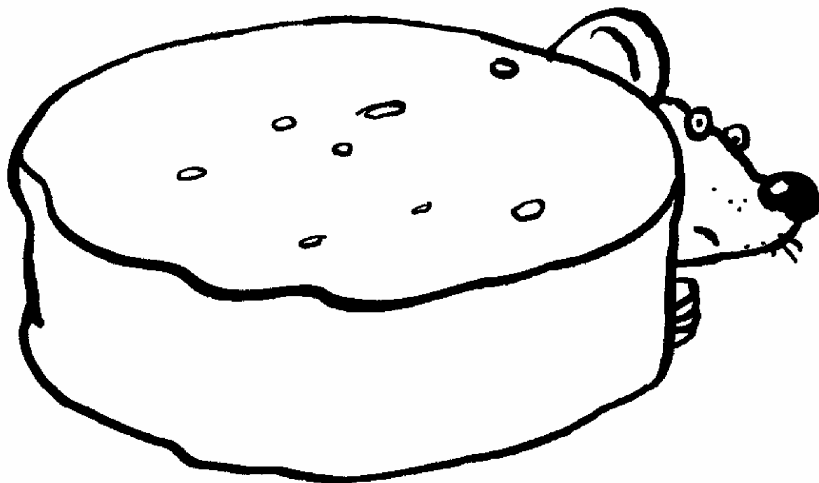

near



behind



in



on

in

on

under

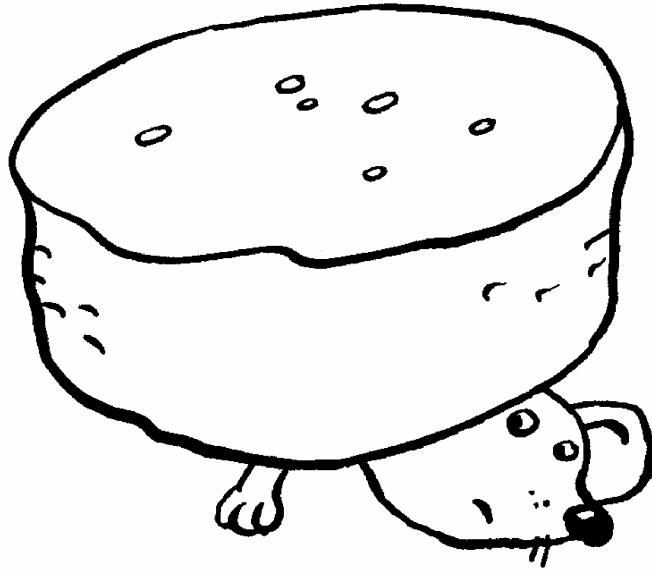

raining

under

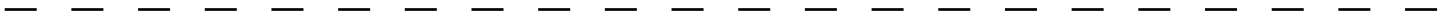

raining

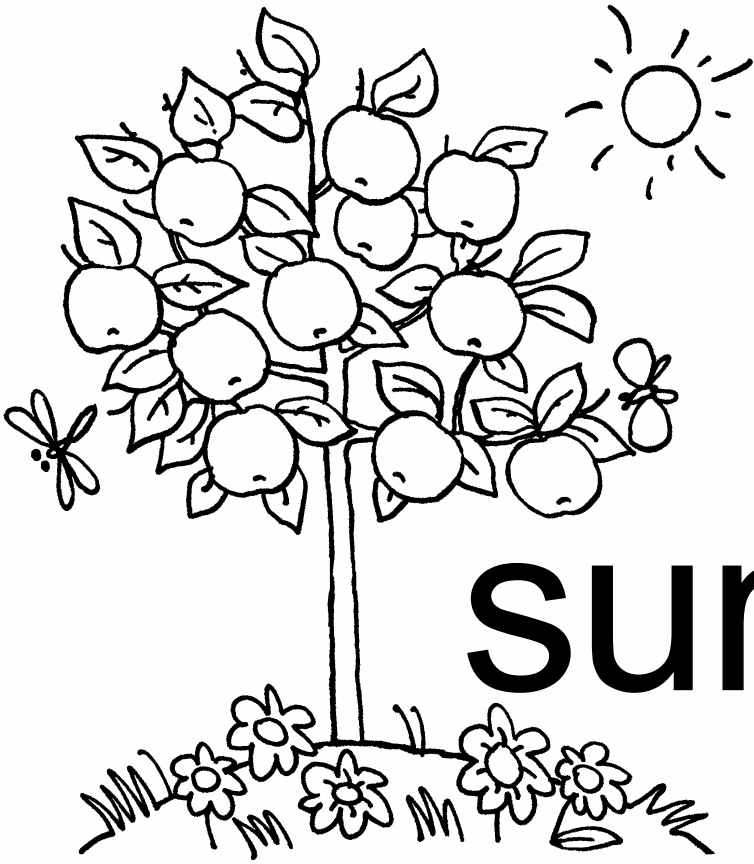

summer

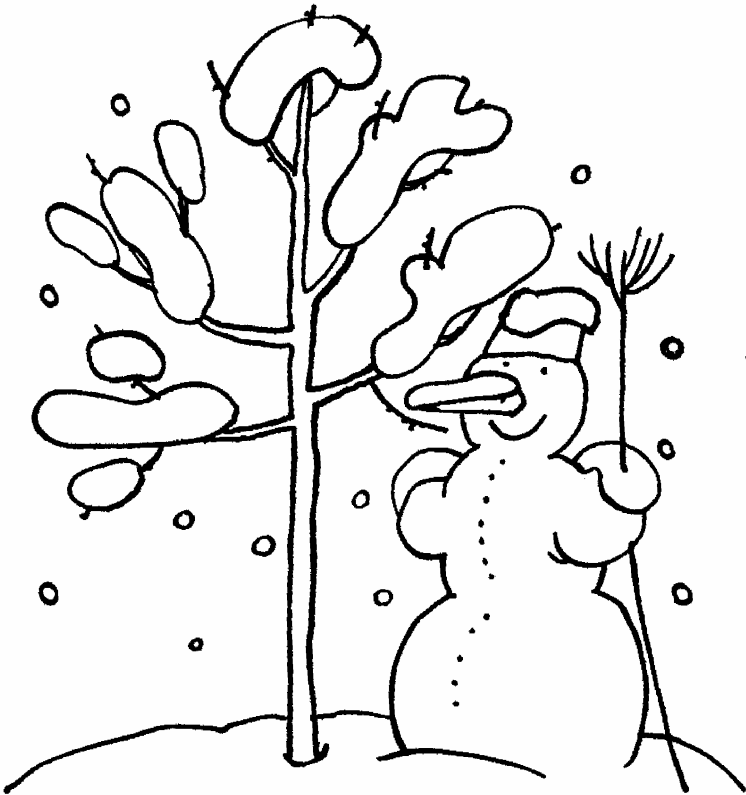

winter

summer



winter

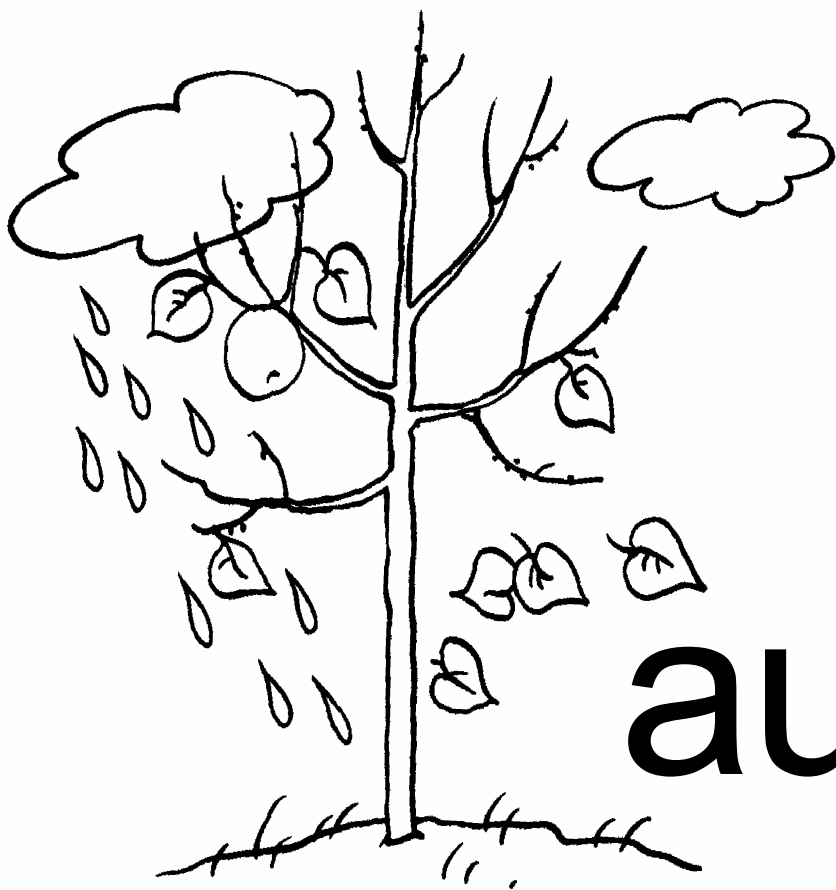

autumn



spring

autumn

spring

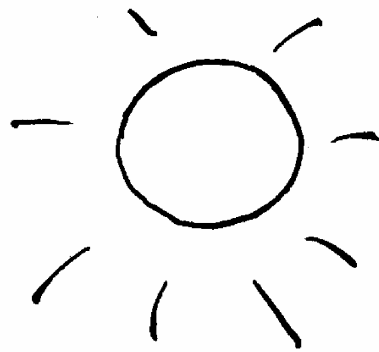

hot

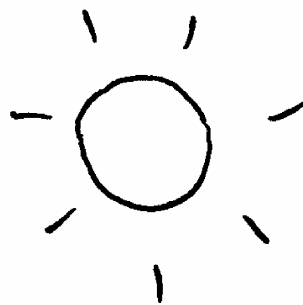

warm

hot

warm



cold

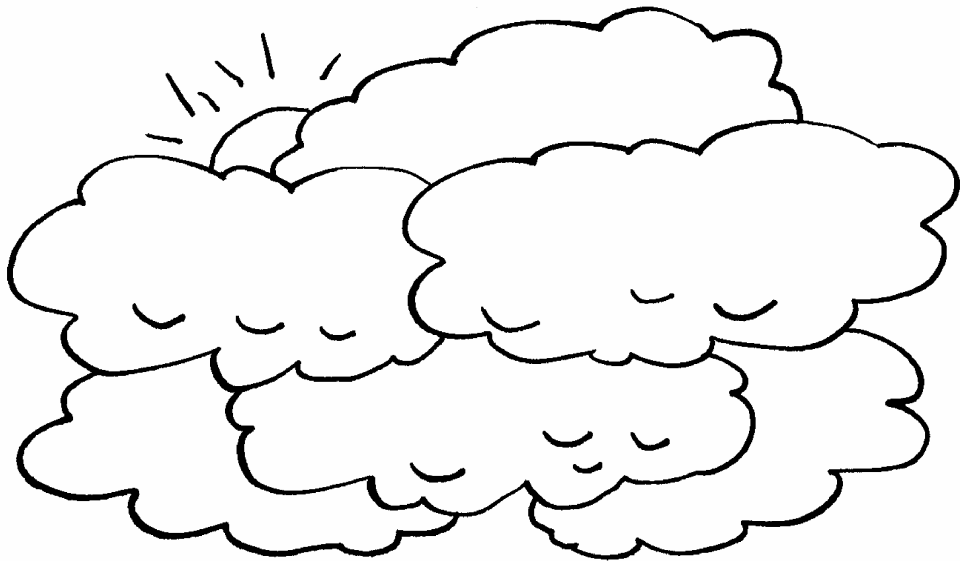

cloudy

cold



cloudy



windy

foggy



windy

foggy

sunny

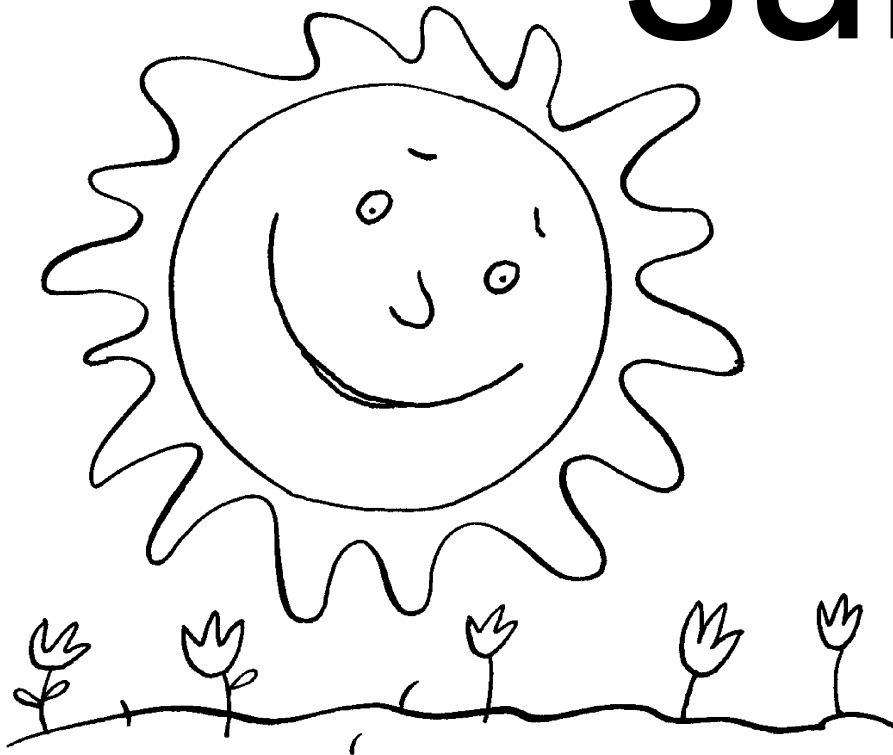

snowing



sunny



snowing



sh [ʃ] I wash and
brush my **sheep**.

ch [tʃ] Chocolate
chickens.

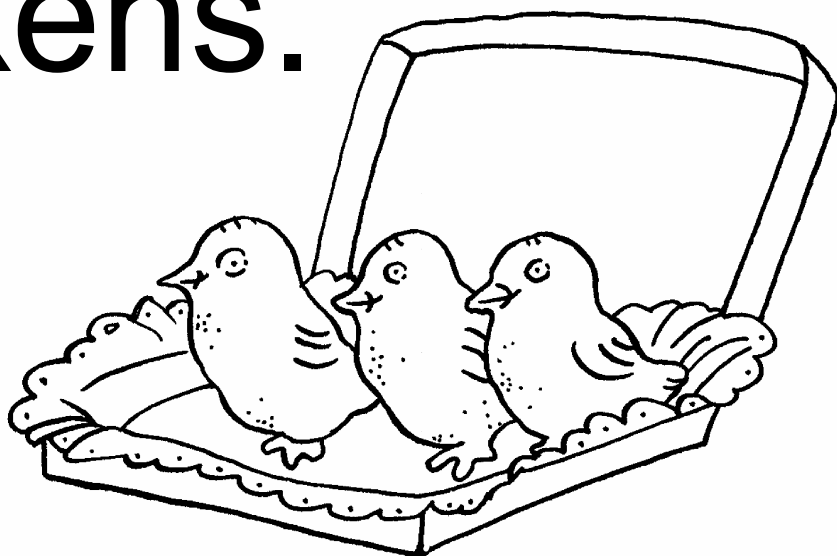

**ee [i:] Three
green teeth.**



**g [g] A green
guinea-pig.**



**j [dʒ] Jam
and juice.**

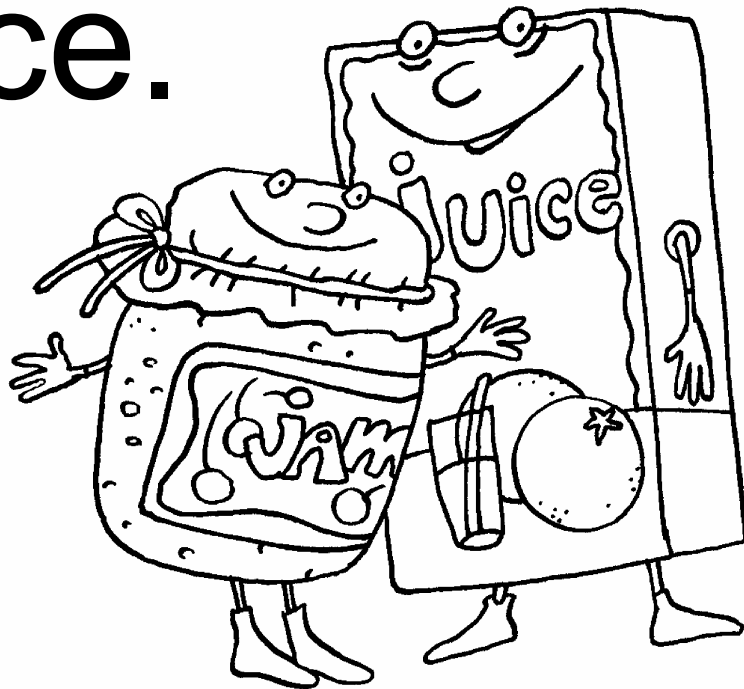

a [æ] A sad cat.

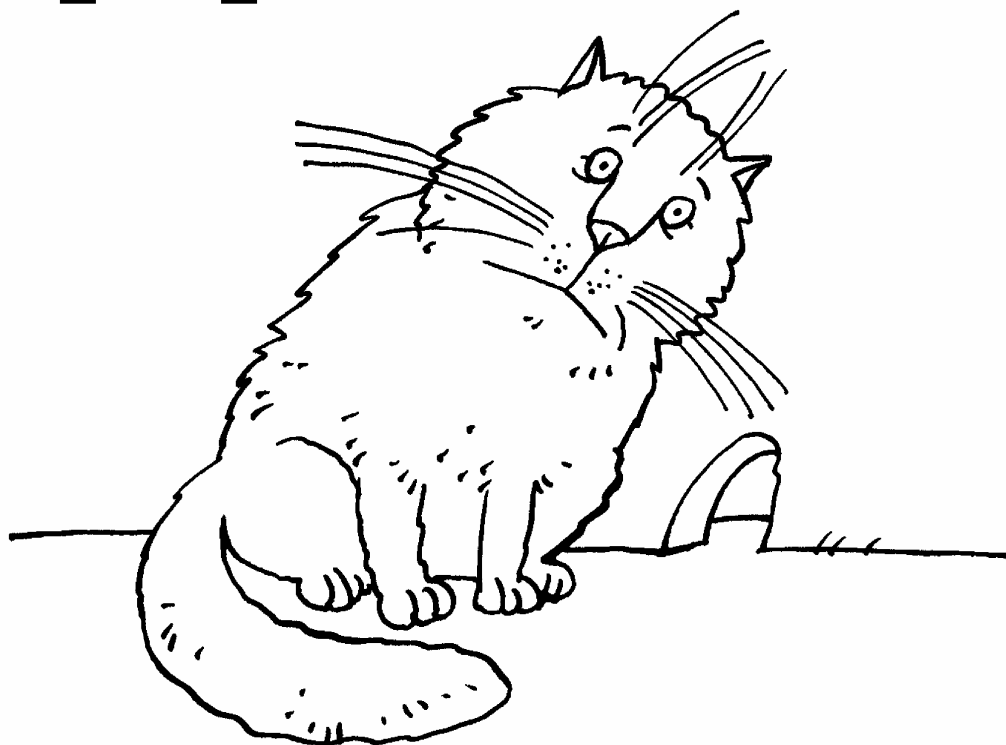

**u [ʌ] A funny
puppy can jump.**



**h [h] A happy
hamster.**



**ck [k] A chicken
and a duck.**

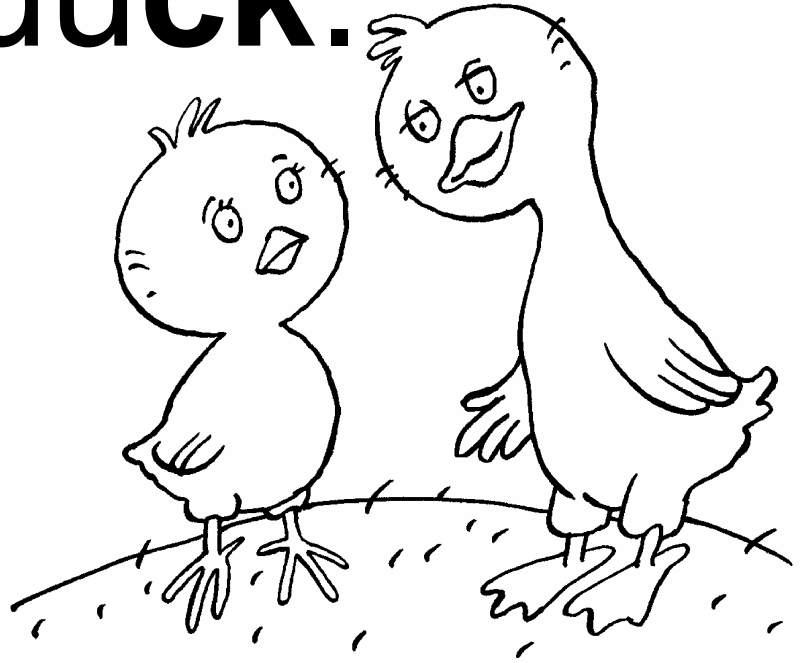

**c [k] Cucumbers
and carrots for
the cook.**



**y [j] Yoghurt
is yummy.**



**y [ɪ] A funny
puppy.**



**a [eɪ] Kate likes
cake.**



**i [aɪ] Mike likes
ice-cream.**

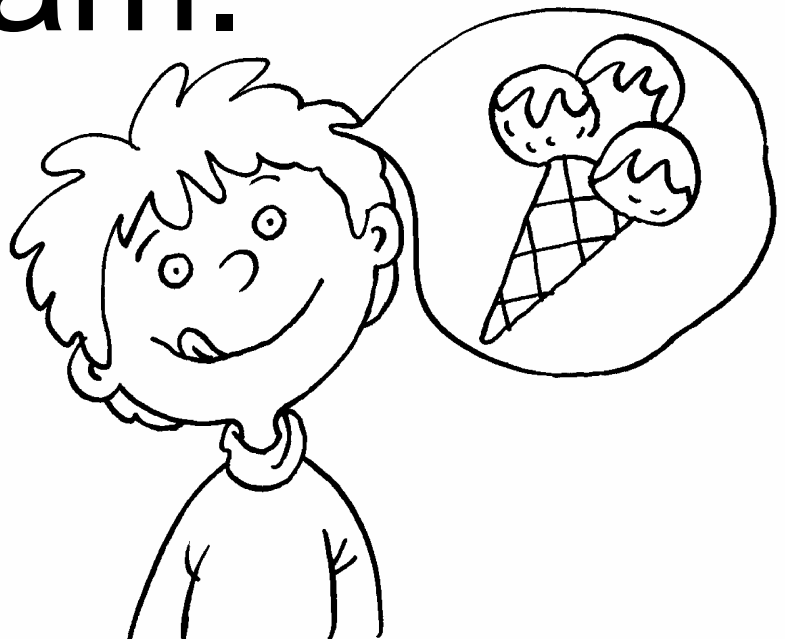

o [ɒ] A dog
and a frog.

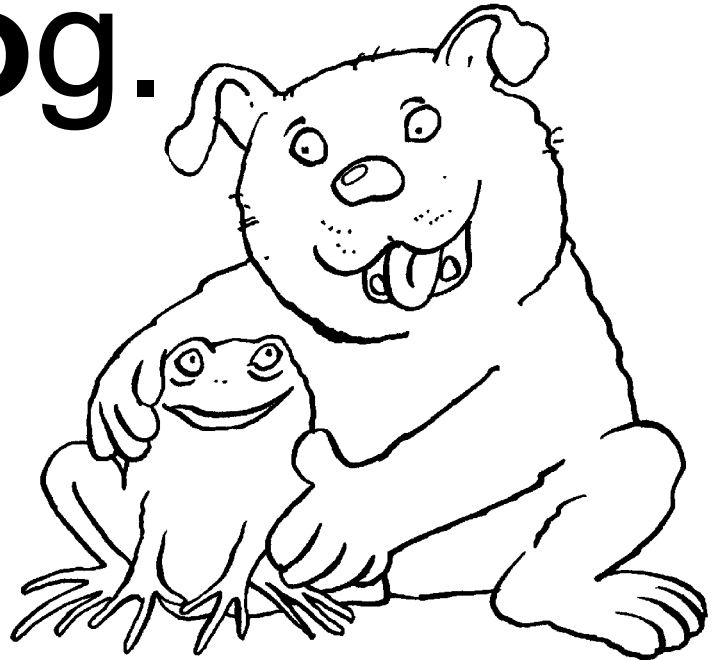

i [ɪ] Pigs swim,
kittens sing.

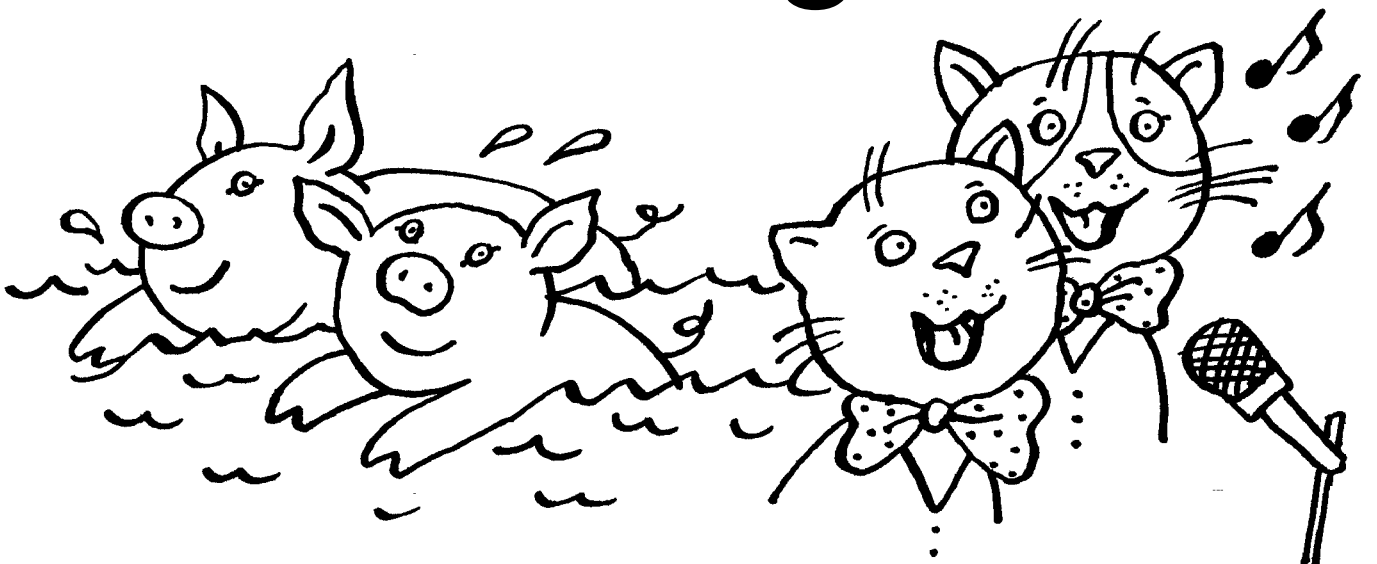

**e [e] Ten pencils
in the pencil-case.**

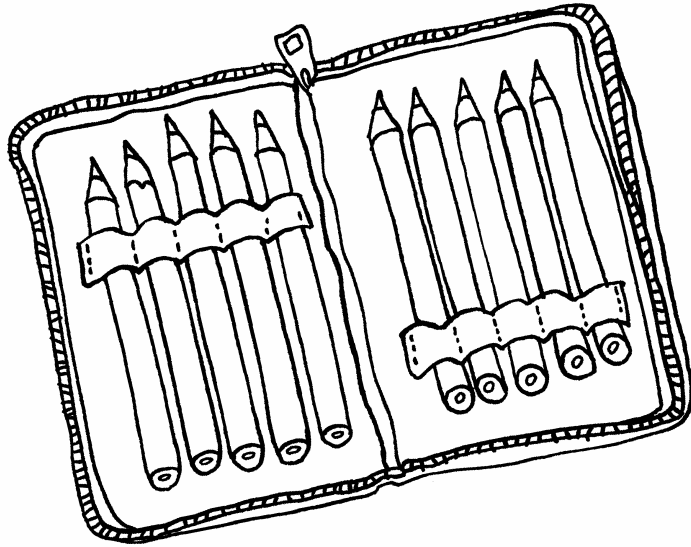

**w [w] Wow!
Sweets can swim!**

oo [ʊ] Look!

**A cook on
the book!**



**r [r] A red rat and
a red rabbit.**



**x [ks] Six foxes
in six boxes.**

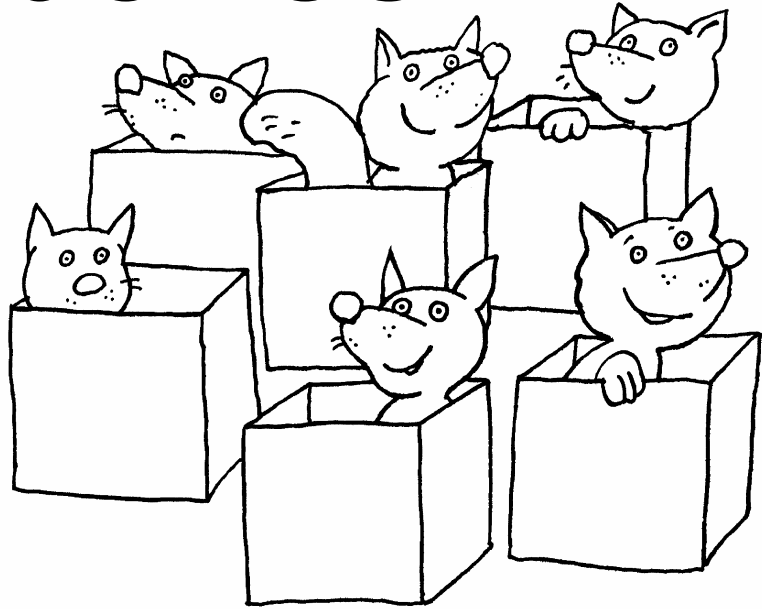

**ay [eɪ] Play football
on Sunday.**



**th [θ] Three pizzas!
Thank you!**



**ng [ŋ] I sing in
the morning.**

