

# ASSEMBLY INSTRUCTION



A

B

C

D



4PCS



4PCS



4PCS



1PC

①

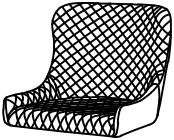

X 1

②



X 1

③

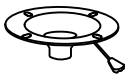

X 1

④

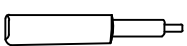

X 1

⑤

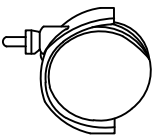

X 5

⑥



X 1

Step:1

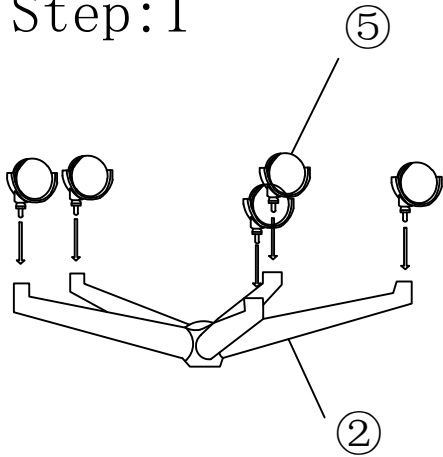

Step:2

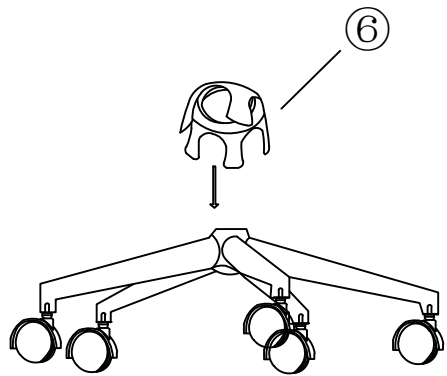

Step:3

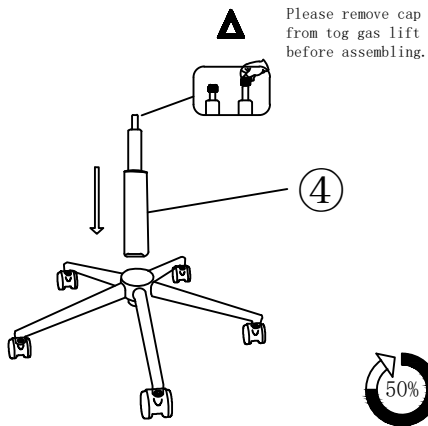

Step:4

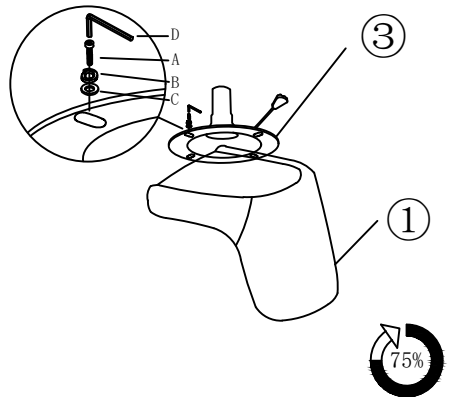

Step:5

