



ВИДЕОИНСТРУКЦИЯ ОТ ПОХОЖЕЙ МОДЕЛИ 5051



SHTABE.DESIGN

SHTABE

ROYAL 5041
ROYAL 5041 ECO

5041

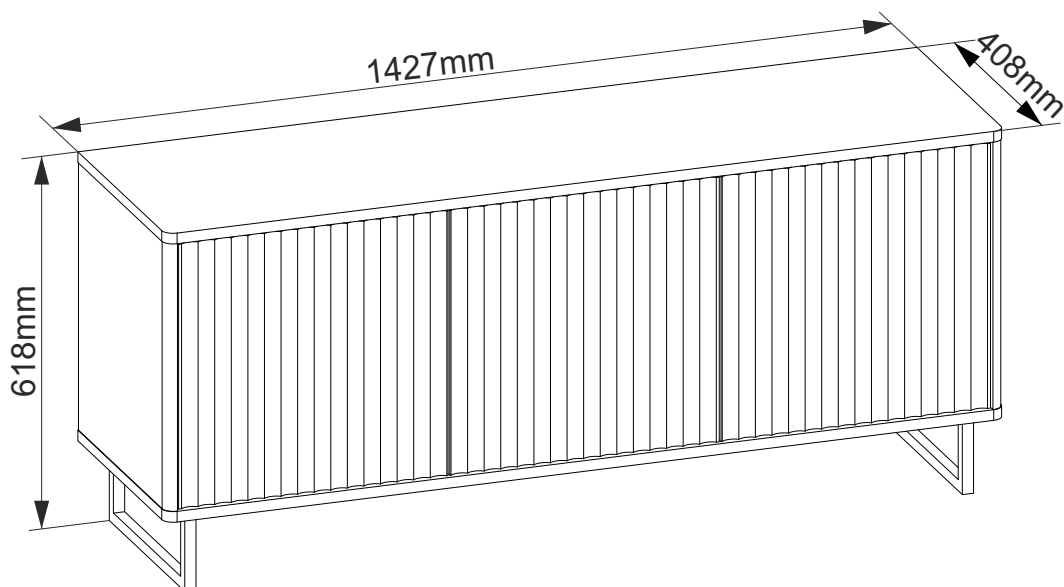

DEUTSCH Fachkundige Montage erforderlich. Unsachgemäße Montage kann zu Unfällen führen. Da es viele verschiedene Wandmaterialien gibt, sind Schrauben für die Wandbefestigung nicht beige packt. Erkundigen Sie sich ggf. beim Eisenwarenfachhandel nach geeignetem Befestigungsmaterial.

ENGLISH Assembly should be carried out by a qualified person, because wrong assembly may lead to that the furniture will topple over and cause injury or damage. As wall materials vary, screws for fixing to wall are not included. For advice on suitable screw systems, contact your local specialised dealer.

FRANÇAIS Le montage doit être effectué par une personne compétente. Un montage mal effectué peut provoquer la chute du meuble et blesser quelqu'un. Les vis et ferrures pour fixer le meuble au mur ne sont pas incluses. Choisissez des vis et ferrures adaptées au matériel de votre mur. En cas de doute, demandez conseil à un vendeur spécialisé.

ITALIANO Il montaggio deve essere effettuato da una persona competente. Se non viene effettuato correttamente, il prodotto può ribaltarsi o cadere, danneggiando persone o cose. Poiché ci sono pareti di materiali diversi, le viti per il fissaggio alla parete non sono incluse. Per scegliere gli accessori di fissaggio adatti, rivolgetevi a un rivenditore locale.

ESPAÑOL Mantaje a realizar por montador autorizado, pues un montaje erróneo puede resultar en una caída del mueble, causando daños a personas o cosas. Como hay muchas clases de materiales de pared, no se incluyen los tornillos de montaje. Para sugerencias sobre sistemas de colocación adecuados, ponte en contacto con tu especialista más cercano.

PORTUGUES A montagem deverá ser realizada por uma pessoa qualificada, pois uma montagem incorreta pode povocar a queda do móvel e causar lesões ou estragos. Como os materiais de parede variam, os parafusos para fixar à parede não estão incluídos. Para mais conselhos sobre o sistema de parafusos adequado, consulte o seu retalhista local especializado.

NEDERLANDS De montage dient te worden uitgevoerd door een vakbekwaam iemand. Foutieve montage kan ertoe leiden dat het meubel omvalt, waardoor er persoonlijk letsel of schade kan ontstaan. Omdat er veel verschillende wandmaterialien bestaan, zit er geen wandbeslag bijgesloten. Voor advies over geschikt wandbeslag, neem contact op met de vakhandel.

SVENSKA Monteringen ska utföras av kunnig person, då feilmontering kan leda till att möbelen faller och skadar någon eller något. Eftersom det finns många olika väggmaterial, medföljer ej skruvar för vägginfästning. För råd om lämpliga skruvsystem, kontakta din lokala fackhandlare.

БЪЛГАРСКИ Необходим е монтаж от специалист. Неправилният монтаж може да причини злополуки. Тъй като има много различни стенини материали, винтовете за стенин монтаж не са приложени. При нужда се информирайте в специализираните железарски магазини за подходящия крепежен материал.

SLOVENSKO Potrebna je strokovna montaža. Nepravilna montaža lahko vodi do nezgod. Ker obstajajo različni stenski materiali, vijaki za pritrditev na zidu niso priloženi. Za ustrezen pritrditveni material se po potrebi pozanimajte v strokovni trgovini z železnino

DANSK Monteringen skal udføres af en kyndig person, da fejlmontering kan fører til at møblet falder og skader nogen eller noget. Eftersom der findes mange forskellige vægmateriale, medfølger der ikke skruer til vægmontering. Ønsker du råd omkring forskellige skruestystemer, kontakt din lokale faghandler.

ČESKY Montáž by měla být provedena kvalifikovanou osobou – nesprávné provedení může vést k převrnutí nábytku a způsobit úraz nebo destrukci. Pro různé zdicí materiály nejsou šroubky a uchycení obsaženy v balení. O vhodném připevnění se porad'te s odborným prodejcem.

SLOVENSKY Montáž by mala byť prevedená kvalifikovanou osobou. Pri nesprávnej montáži môže dôjsť k pádu nábytku, a tým aj k prípadnému úrazu. Skrutky a úchytky na rôzne typy stien nie sú súčasťou balenia. Ak si nie ste istí, obráťte sa na kvalifikovanú osobu.

POLSKI Montaż powinien być przeprowadzany przez wykwalifikowaną osobę, ponieważ złe zmontowanie może spowodować zniszczenie mebla lub może wyrządzić szkodę domownikom. Ponieważ w każdym pomieszczeniu ściany mogą być wykonane z innego materiału, komplet nie zawiera żadnych wkrętów ani umocowań. Aby zasięgnąć porady w kwestii wyboru odpowiednich wkrętów skontaktuj się z lokalnym sklepem specjalistycznym.

MAGYAR Az összeszerelést ajánlatos képzett szakemberre bízni, mert a helytelen összeszerelés következtében a bútor felborulhat és sérülést okozhat. Mivel a fal anyaga lakásonként/otthononként eltérő lehet, a rögzítéshez szükséges csavarokat a csomag nem tartalmazza. A megfelelő csavar kiválasztásáért kérj tanácsot az áruházban a zakképzett személyzettől.

РУССКИЙ Сборка должна производиться специалистом, так как неправильная сборка может привести к опрокидыванию мебели, что может повлечь за собой ущерб или телесные повреждения. Так как материалы стен различаются, шурупы для фиксации к стене не прилагаются. Для выбора подходящих крепежных средств обратитесь в местный специализированный магазин.

ROMÂNĂ Necesită montaj de specialitate. Montarea necorespunzătoare poate cauza accidente. Deoarece există multe materiale diferite pentru pereți, șuruburile pentru fixarea pe perete nu sunt incluse în ambalaj. Solicitați informații eventual de la magazinul specializat în articole de feronerie privind materialul de prindere adecvat.

HRVATSKI Potrebna stručna montaža. Nestručna montaža može dovesti do nesreća. Budući da postoje različiti zidni materijali, vijci za pričvršćenje na zid nisu uključeni. Raspitajte se npr. u željezarnji o prikladnim materijalima za pričvršćenje.

TÜRKÇE Uzman kişilerce montaj yapılması gereklidir. Usulüne uygun yapılmayan montaj kazalara yolaçabilir. Çok sayıda duvar malzemesi olduğundan duvara sabitleme vidaları beraberinde verilmemiştir. İcabi halinde demirden yapılmış araç gereç satan dükkanlardan uygun sabitleme malzemeleri hakkında bilgi alın.

עברית מומלץ להרכיב את המוצר ע"י איש מקצוע. הרכבה לא נכונה עלולה לגרום לתאונות. עקב השוני בסוגי הקירות, ערכת ברגים לא מצורפת. לבחירת הברגים המתאימים יש להתייעץ עם בעל מקצוע.

Ошибки при сборке*

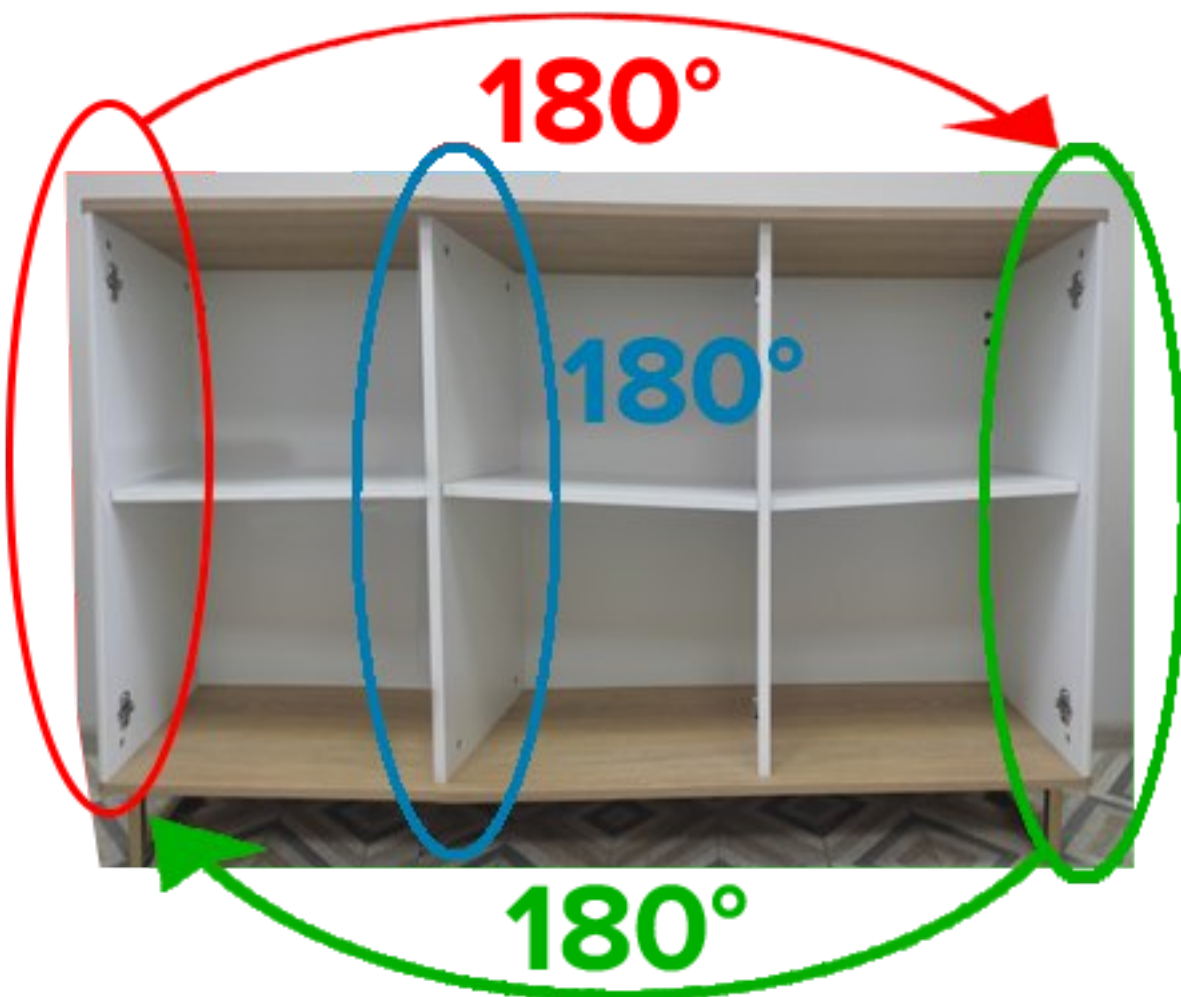
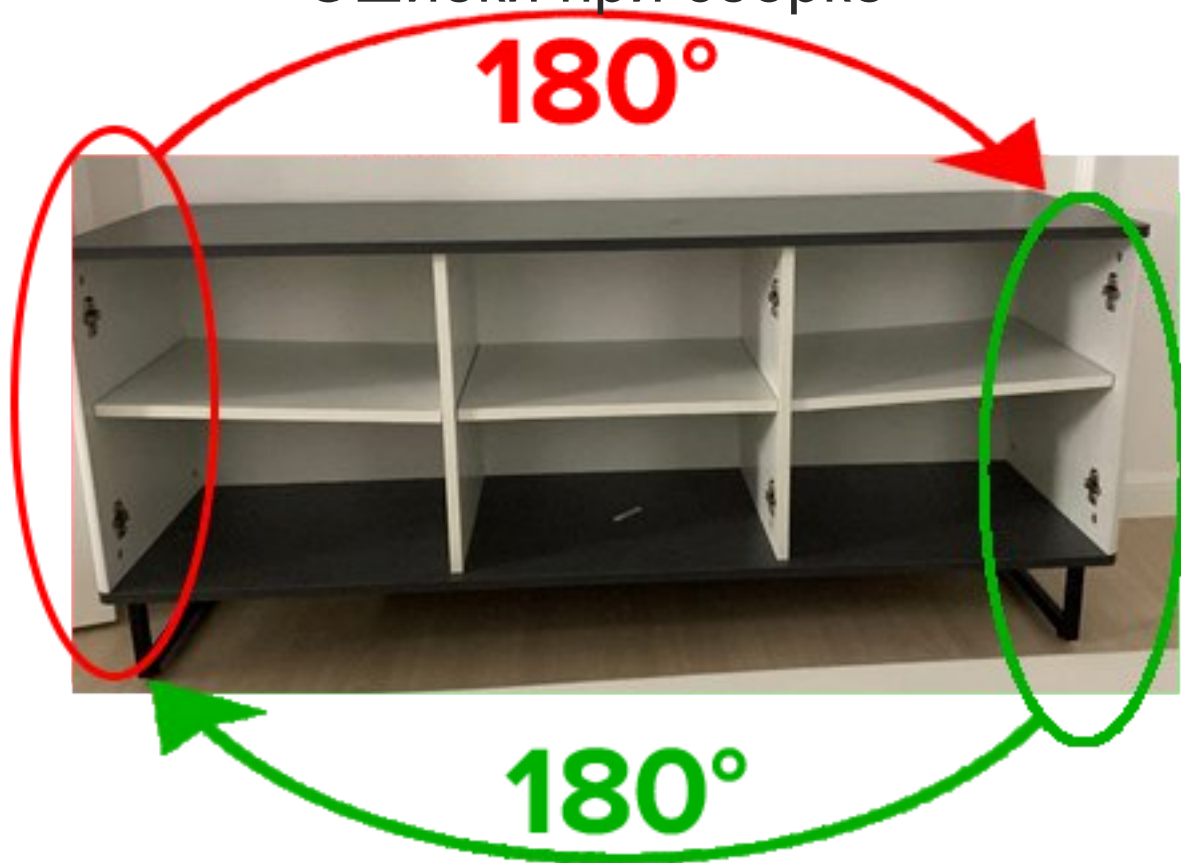

* с 10.01.2023 г. фабрика изготавливает универсальные боковины и перегородки





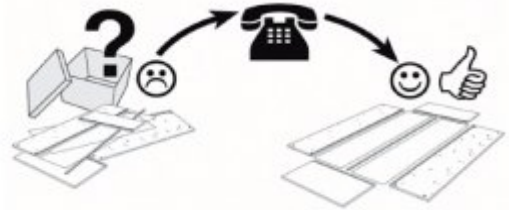



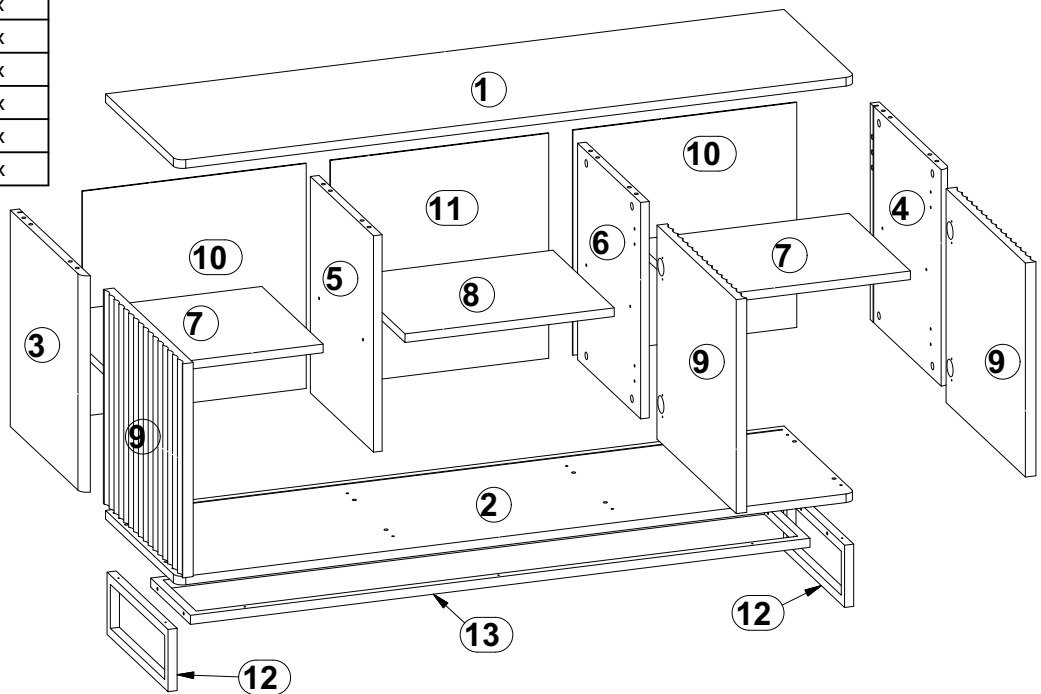

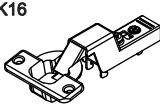
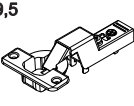
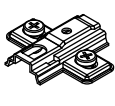

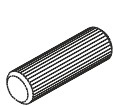
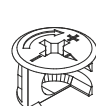
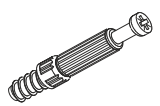

Service • Dienstverlening • Serwis • Servis • Сервисная служба

Name • Naam • Nazwa • İsim • Название
Nr. • No. • Номер
Тур • Туре • Тір • Тип



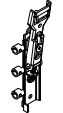

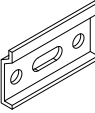
1	1417	408	18	1x
2	1417	408	18	1x
3	452	407	19	1x
4	452	407	19	1x
5	452	362	18	1x
6	452	362	18	1x
7	352	447,5	18	2x
8	352	437	18	1x
9	447	455	22	3x
10	470	467,5	3	2x
11	470	456	3	1x
12	350	130	19	2x
13	1294	228	19	1x

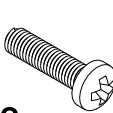
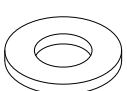
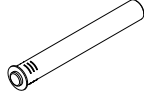
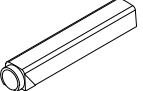
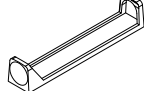

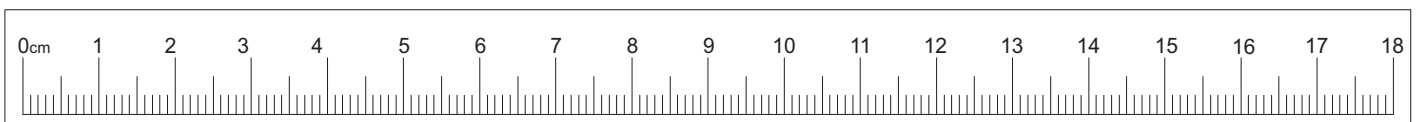
 a1	 a2	 b1	 d1	 f1	 r1	 r42
x4	x2	x6	x12	x16	x16	x16
 s2	 z1	 p51	 l2	 n108	 p38	 n101/L
x16	x1	x22	x16	x4	x4	x1
 n101/P	 p1	 n174	 n54/4	 n54/5	 j63	 o68
x1	x2	x2	x9	x3	x4	x4
 n54/1	 n54/2	 n54/3	x3			
x3	x3	x3				

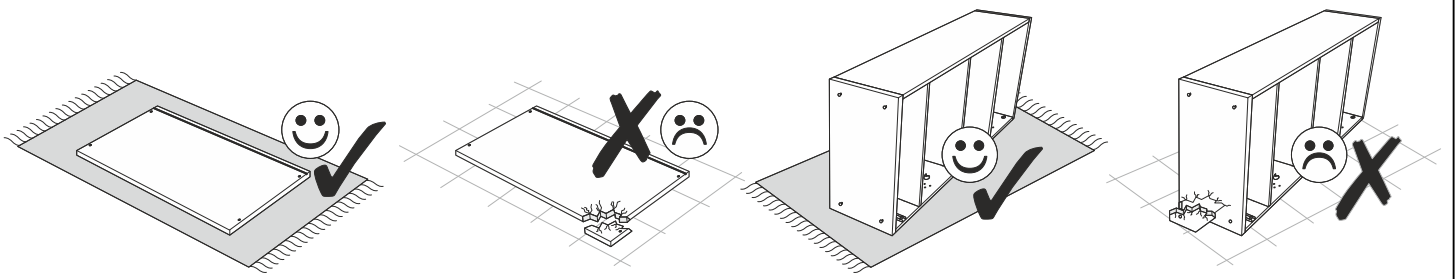



1

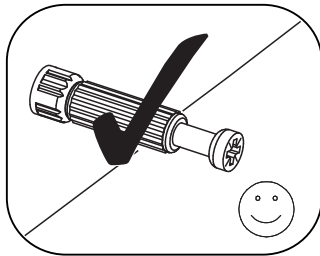
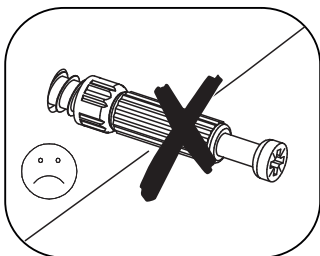
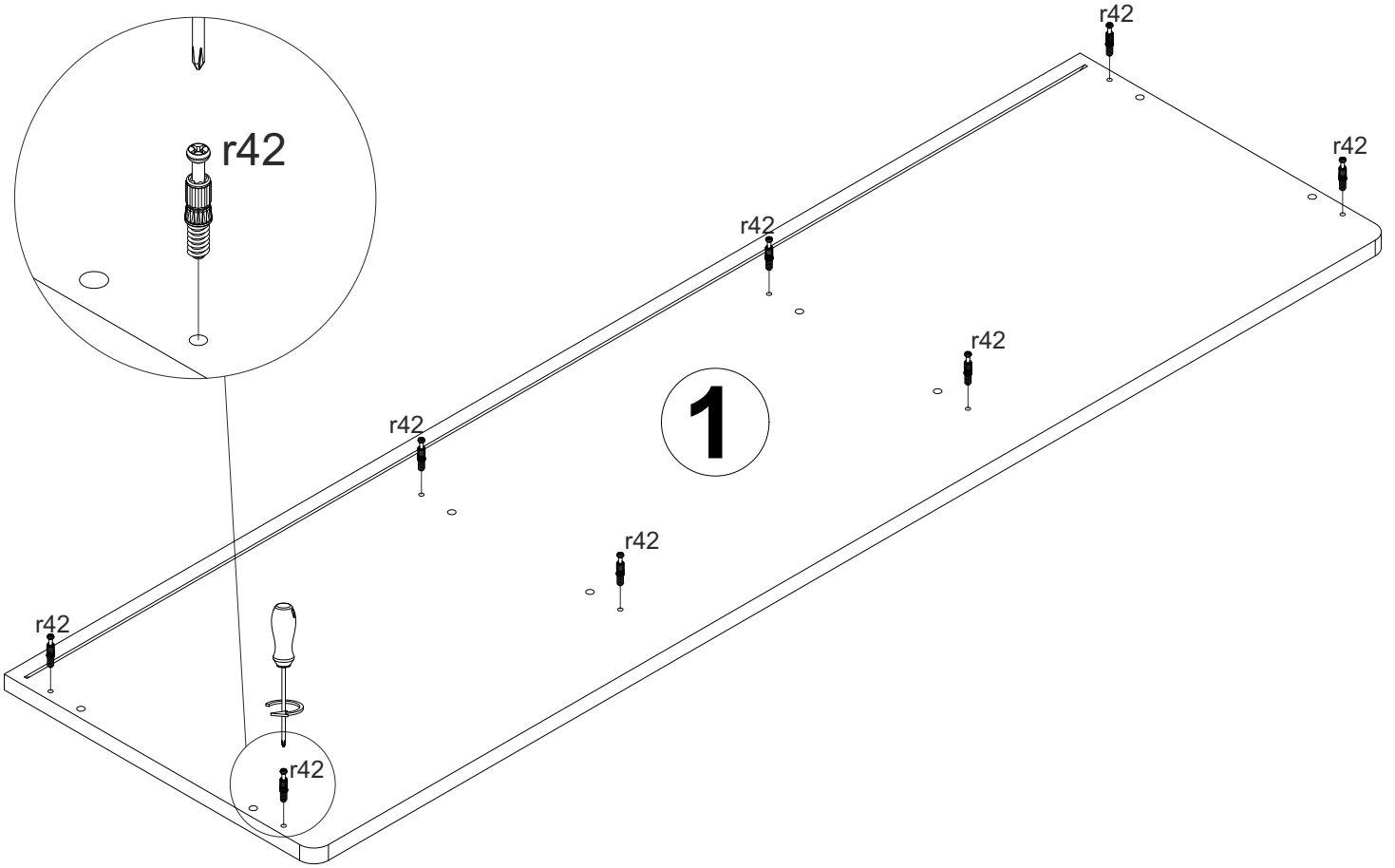
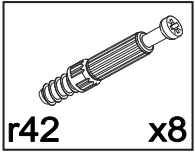

2

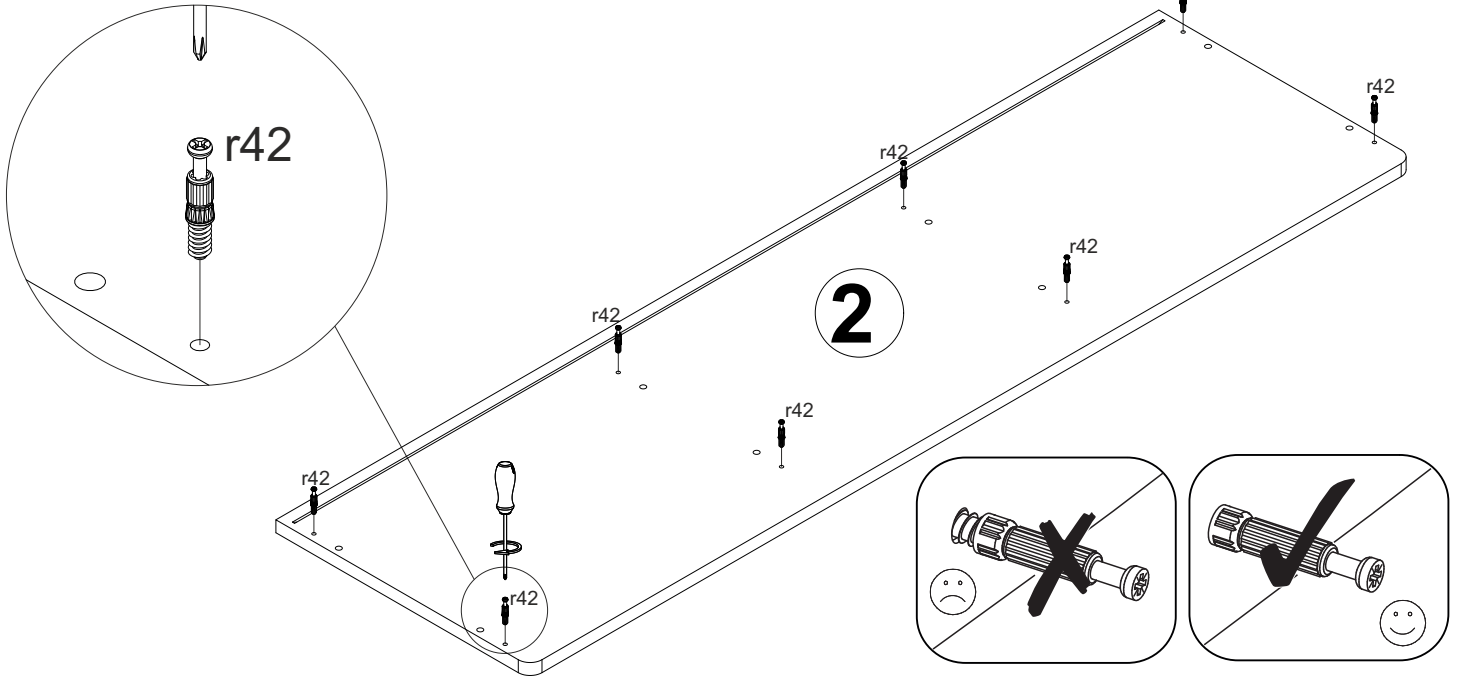
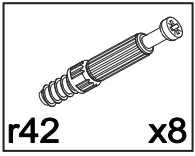

3

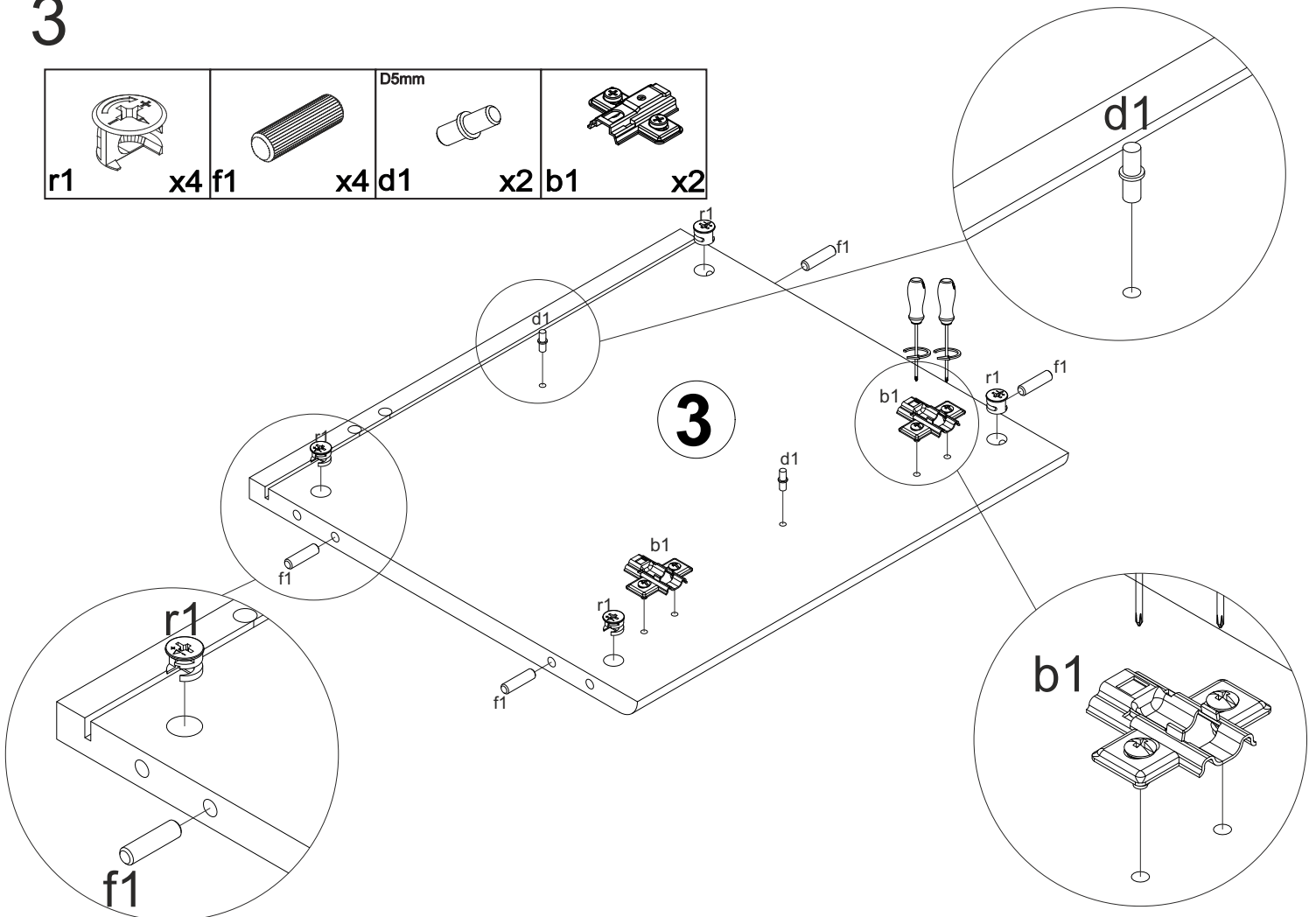
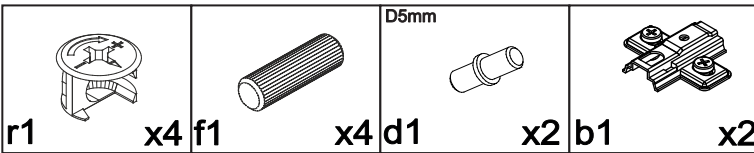

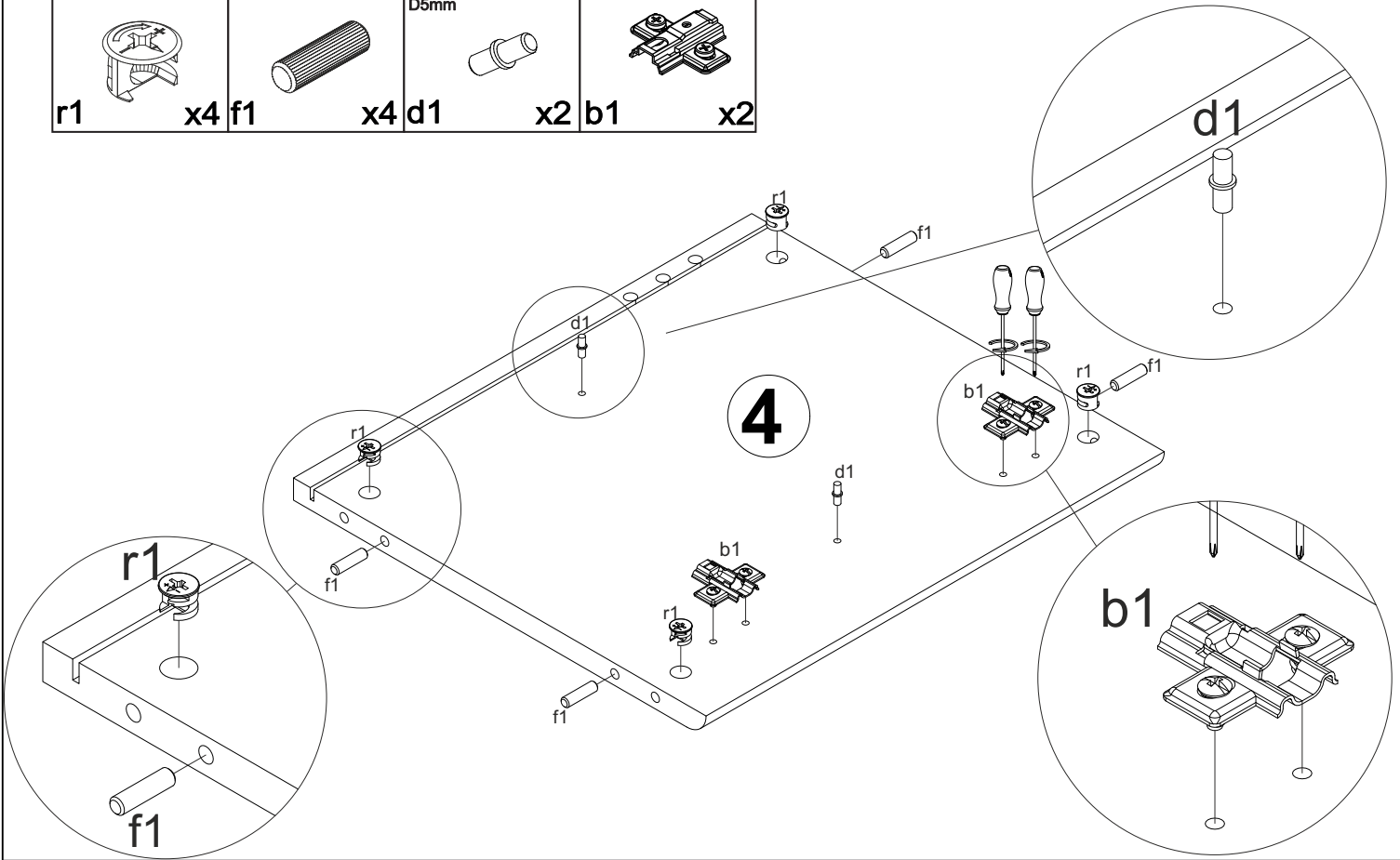
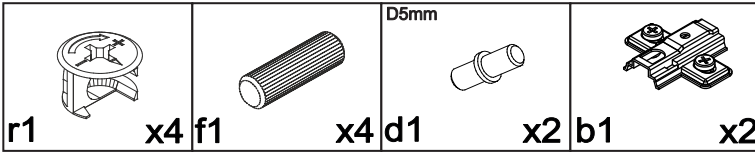

4

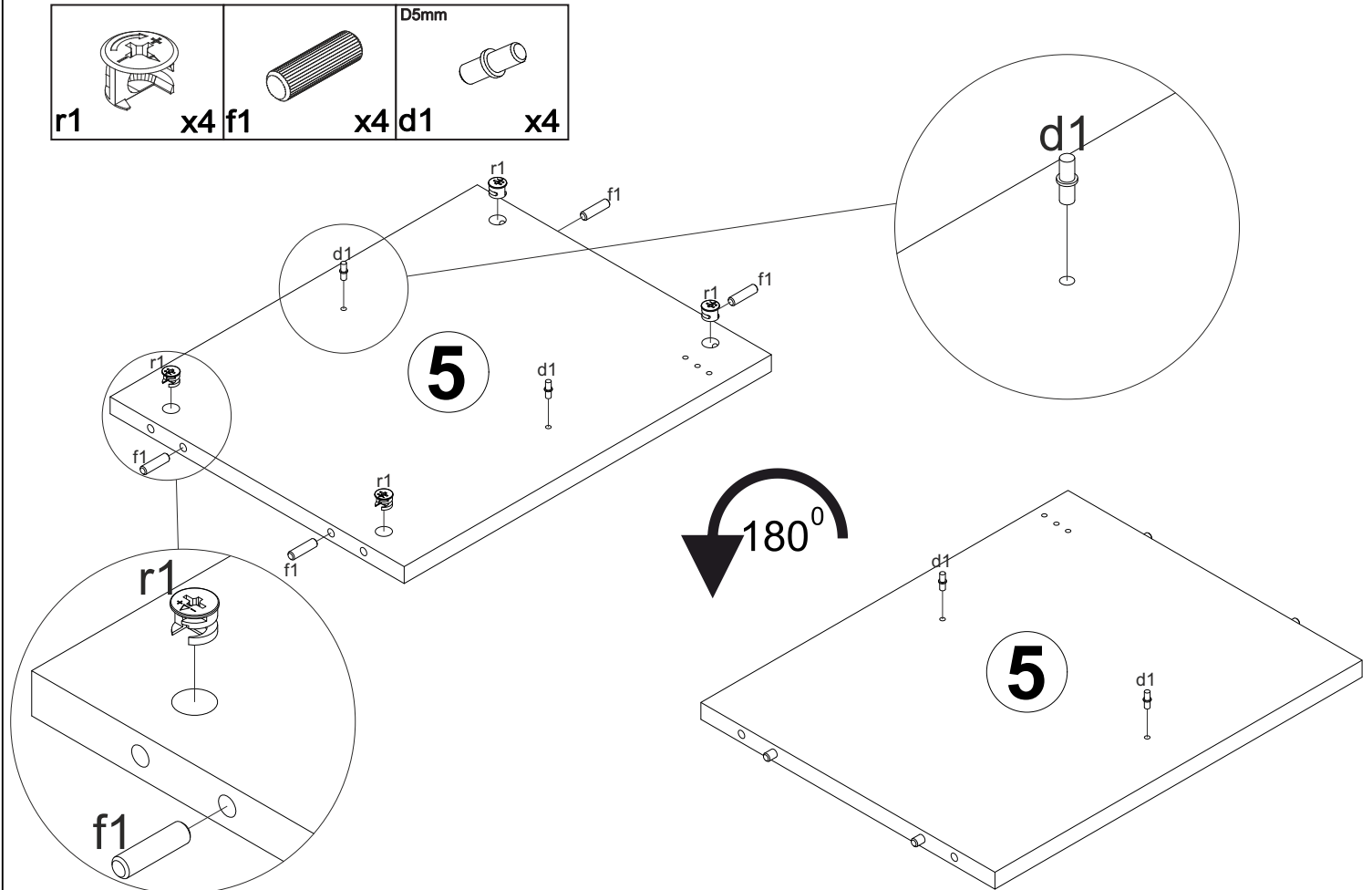
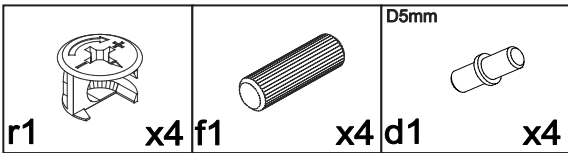

5

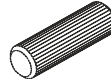

6

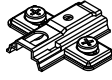
			
r1	x4 f1	x4 d1	x4 b1

D5mm

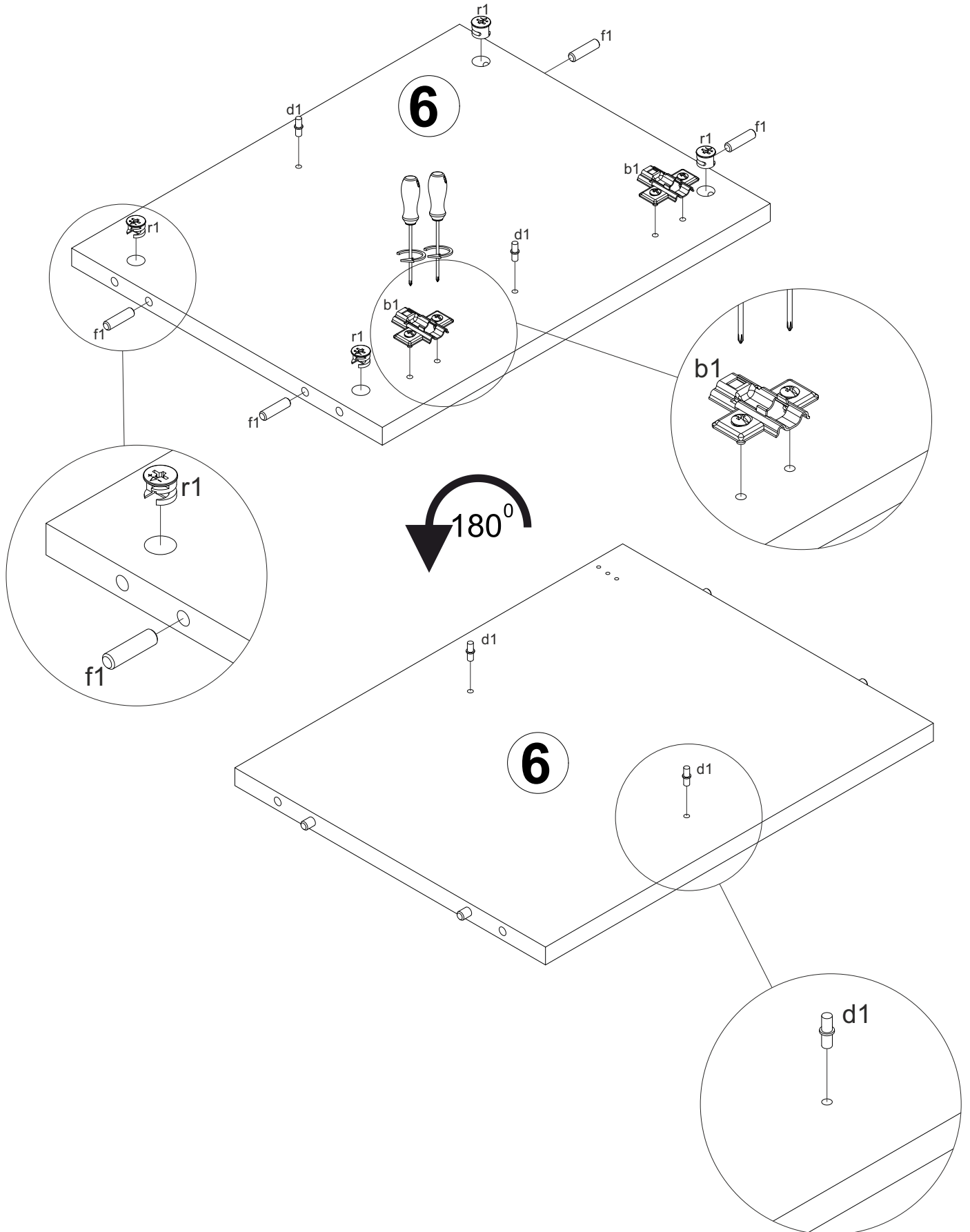

7

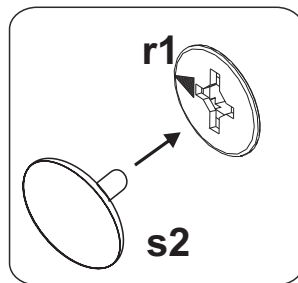
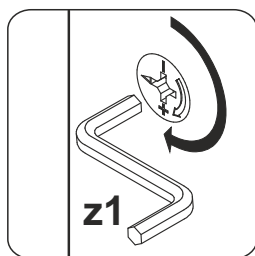
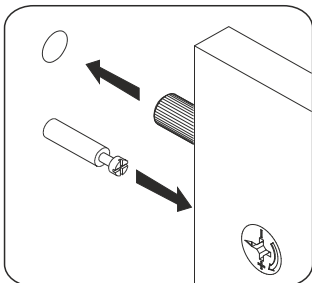
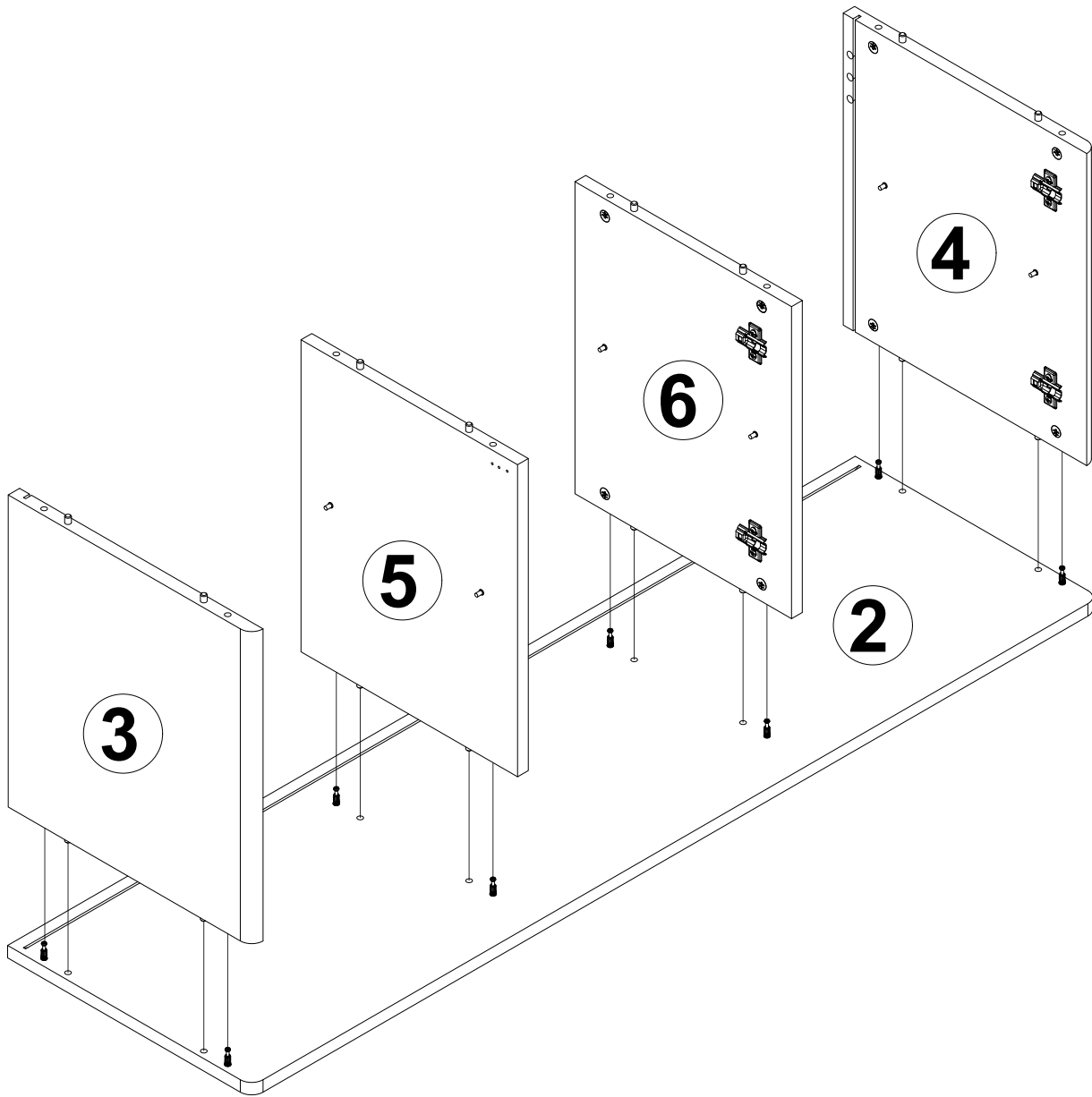
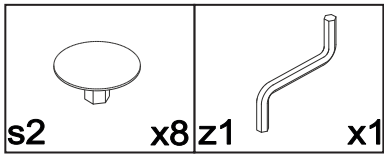

8

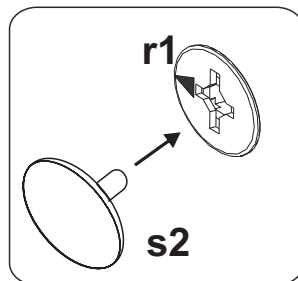
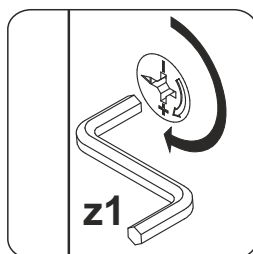
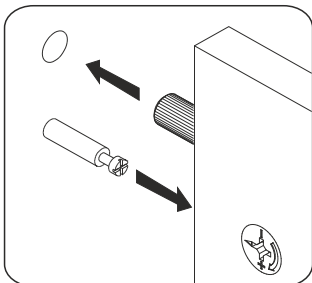
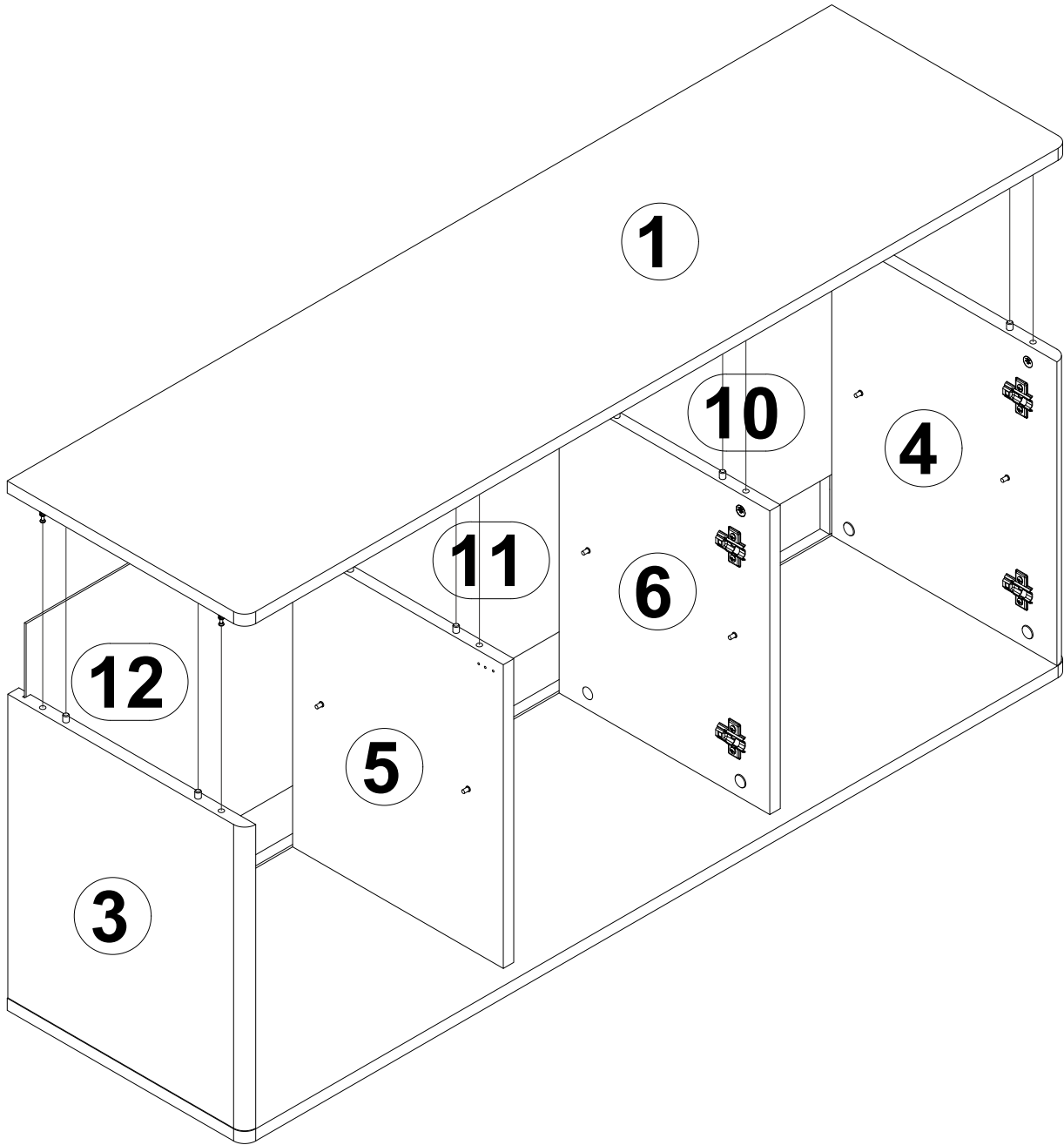
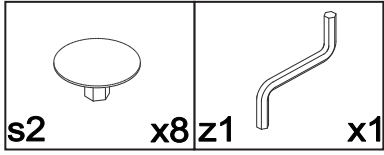

9

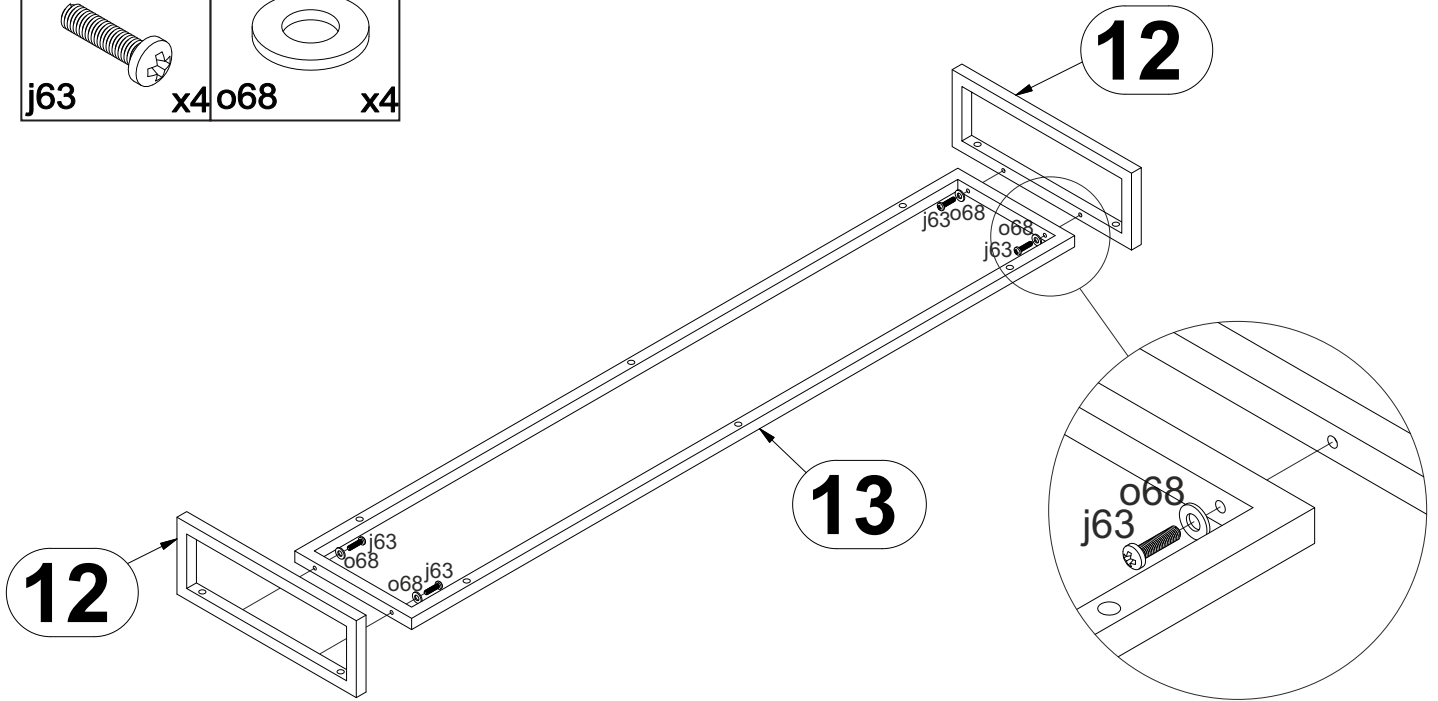
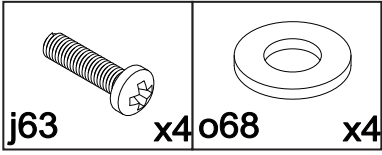

10

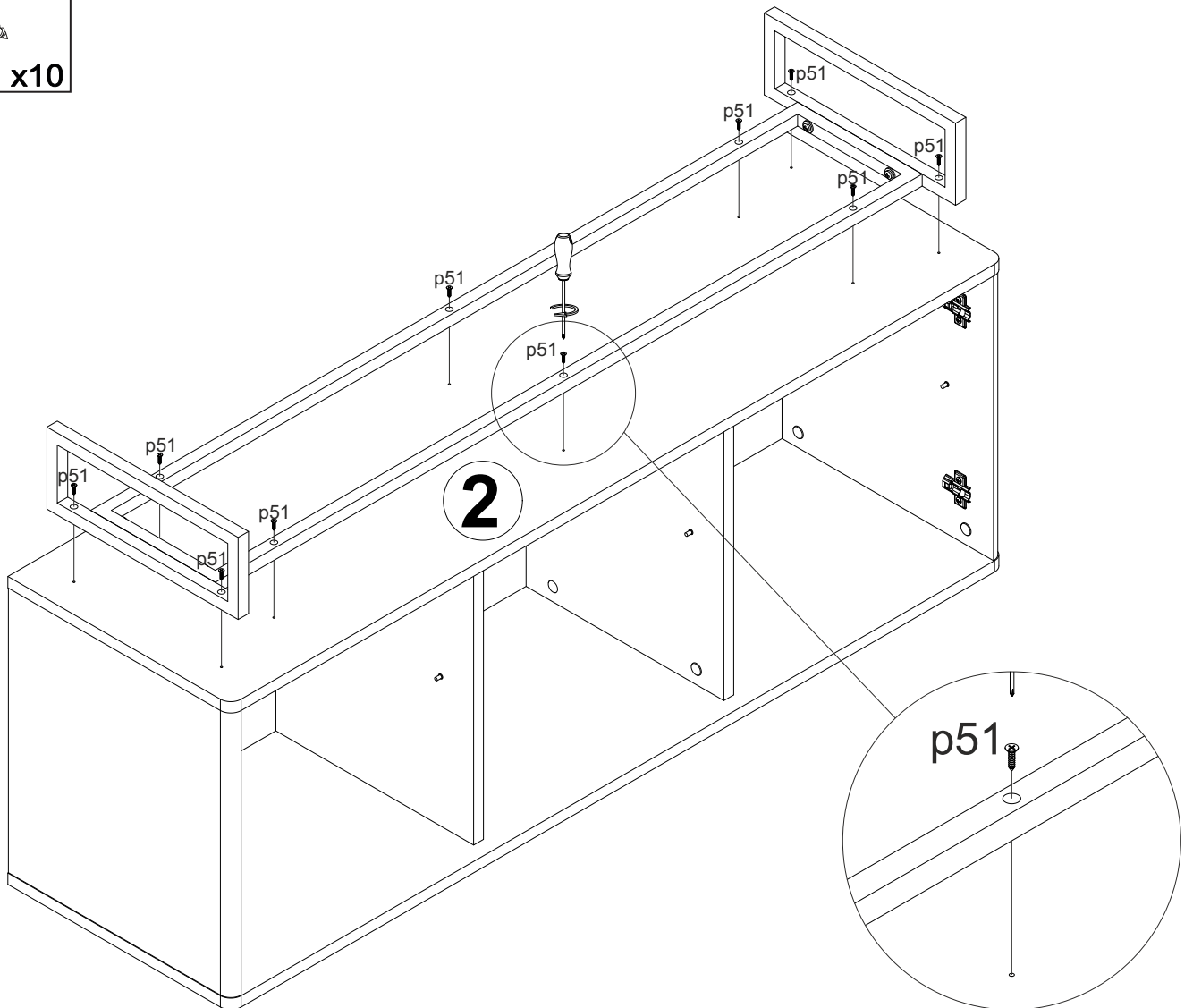
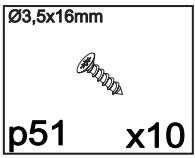

11

	20x13x3,5/1mm	Ø3,5x16mm
I2	x16 n108	x4 p38

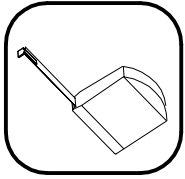

X = Y

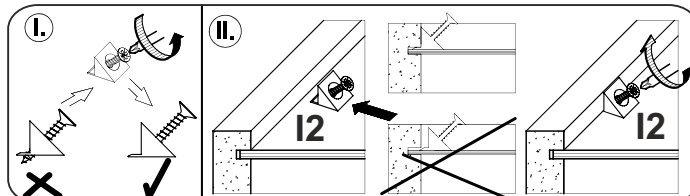
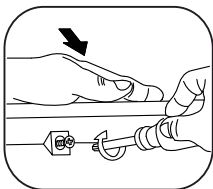
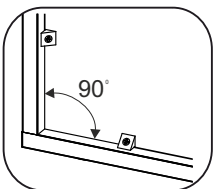
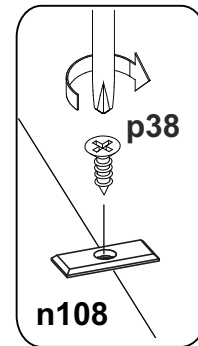
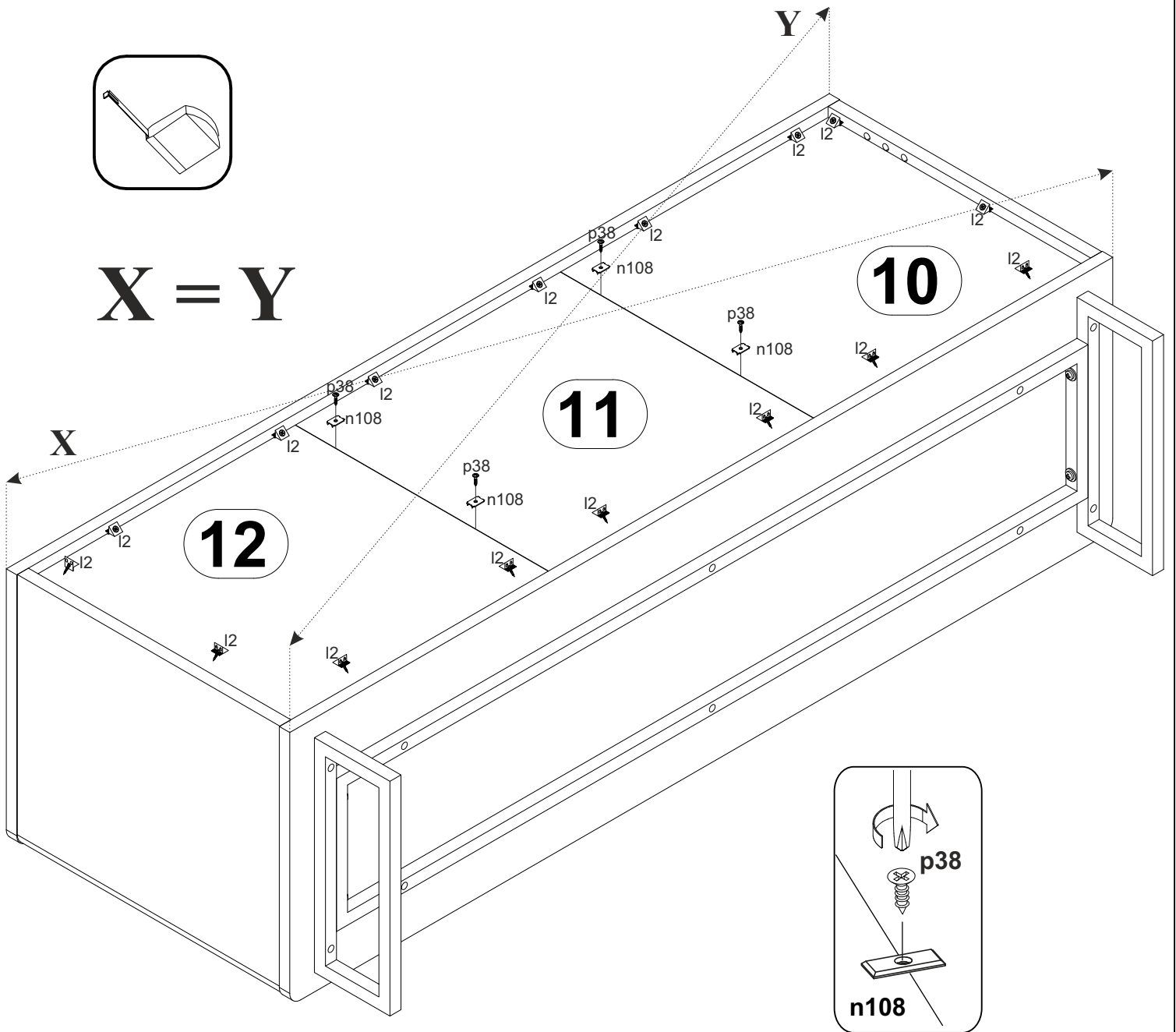

12

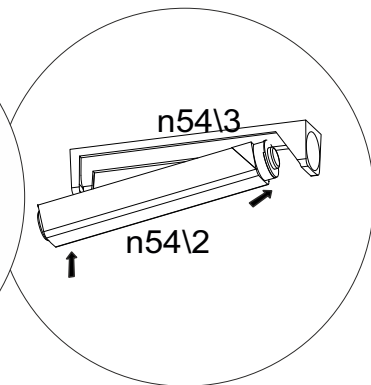
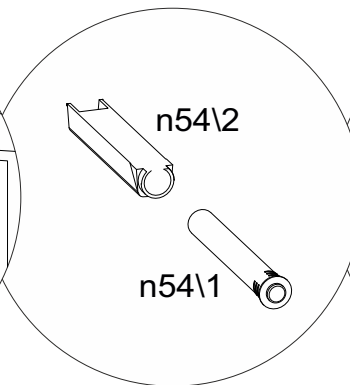
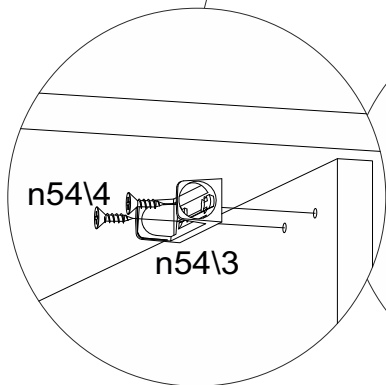
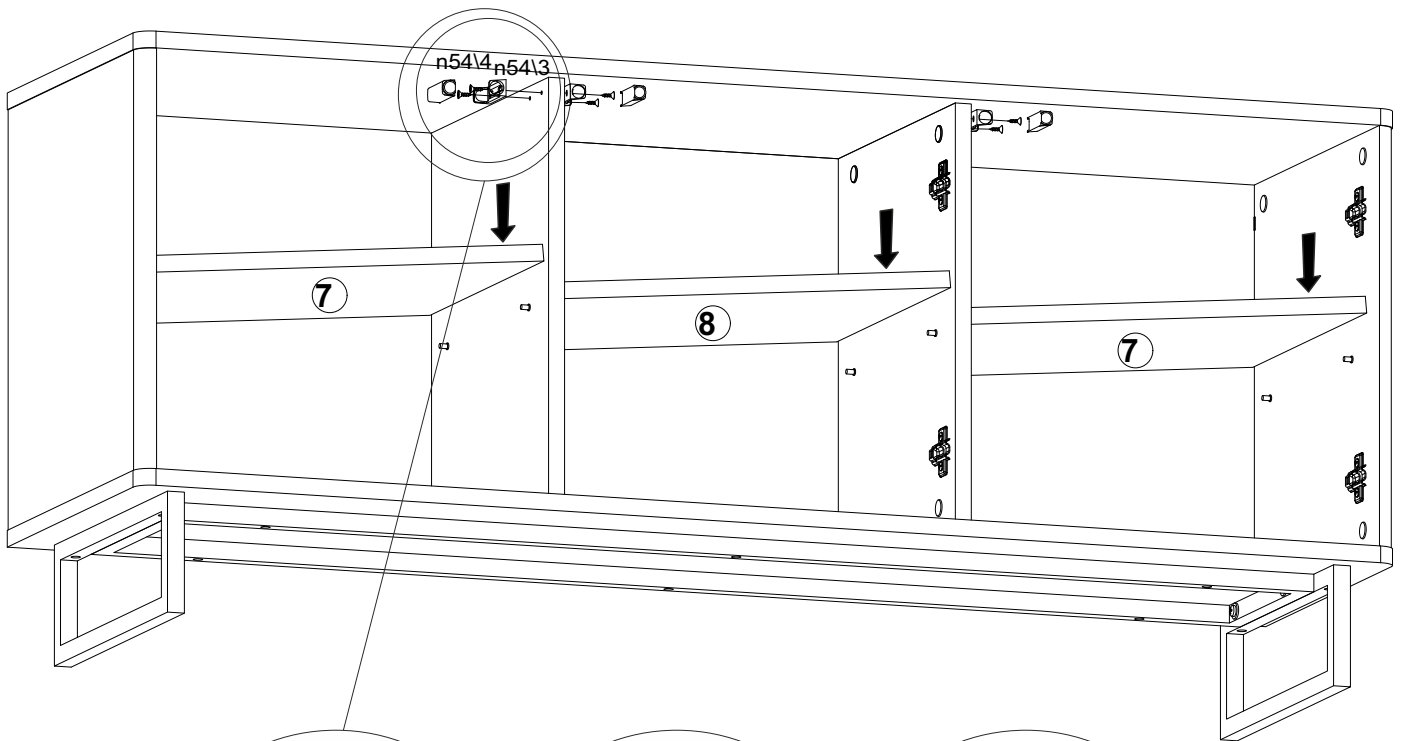
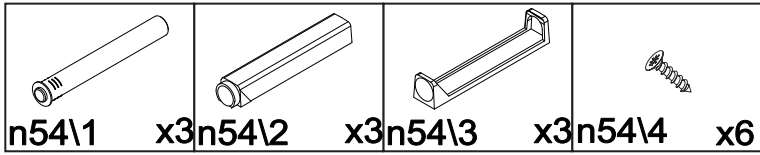

13

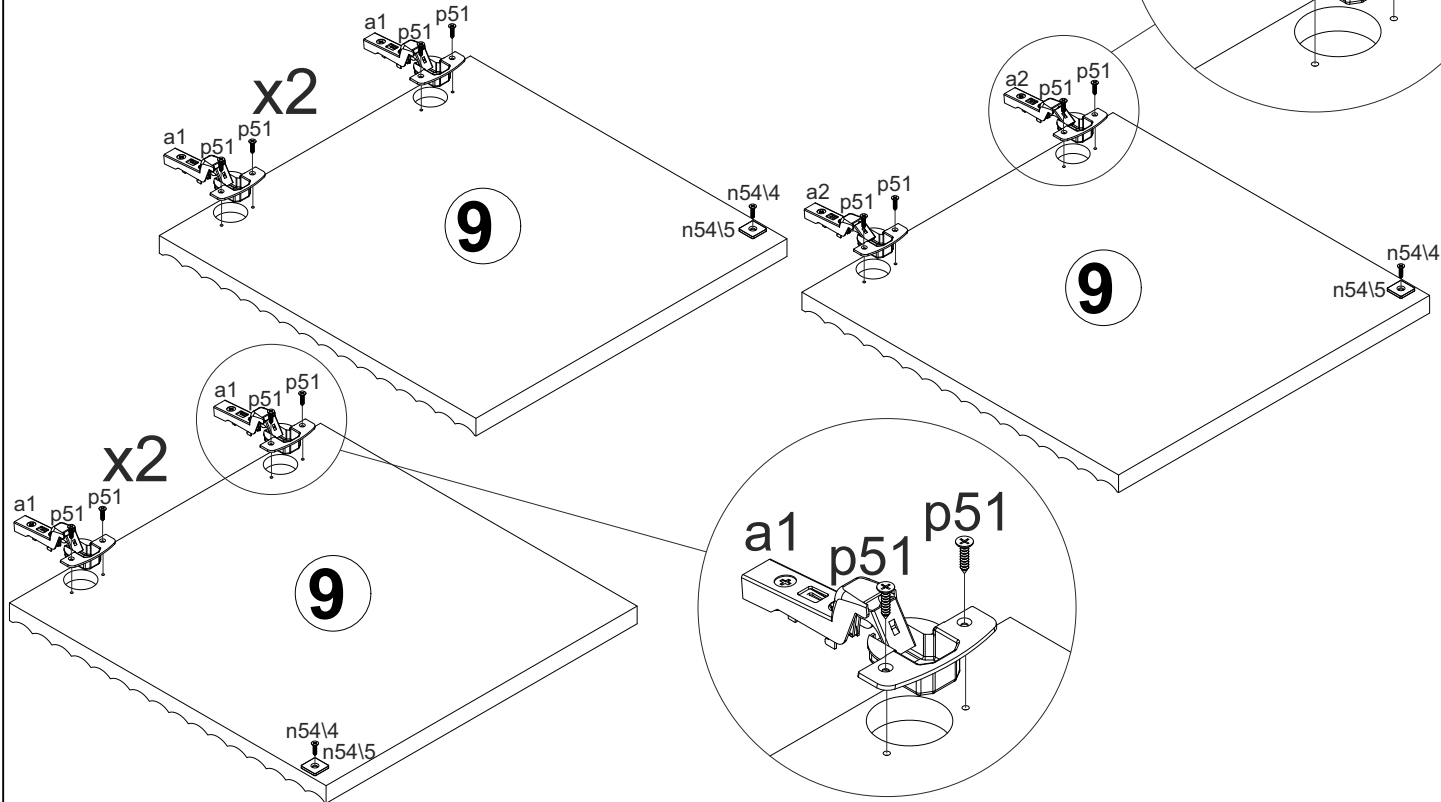

K16			$\varnothing 3,5 \times 16 \text{ mm}$		
a1	x4	a2	x2	p51	x12
			n54/5	x3	n54/4
					x3

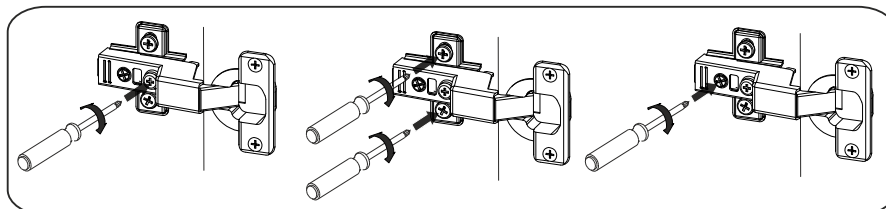
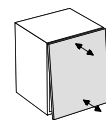
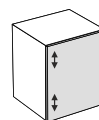
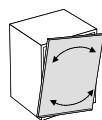
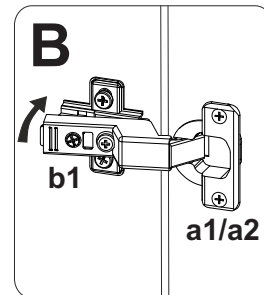
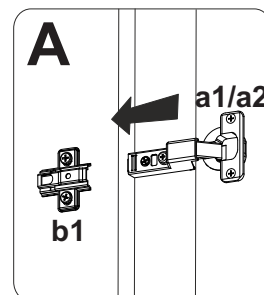
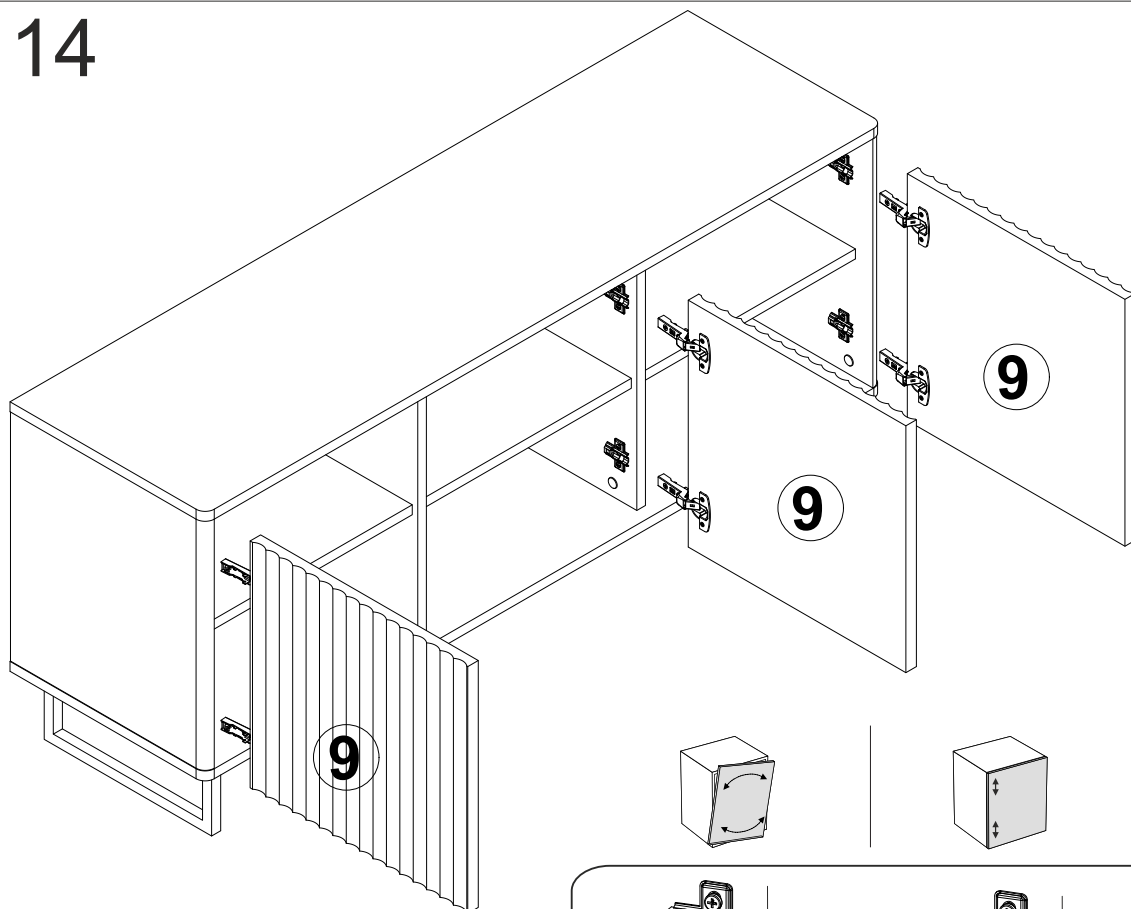

14



15

		$\varnothing 3 \times 20 \text{mm}$ 
n101\L	x1 n101\P	x1 p1
		x2

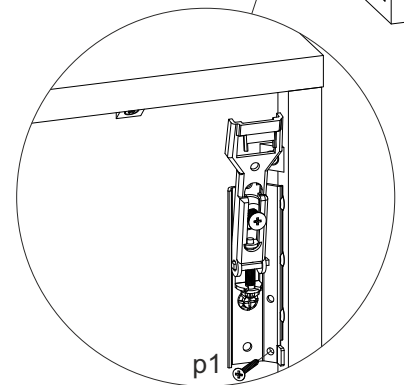
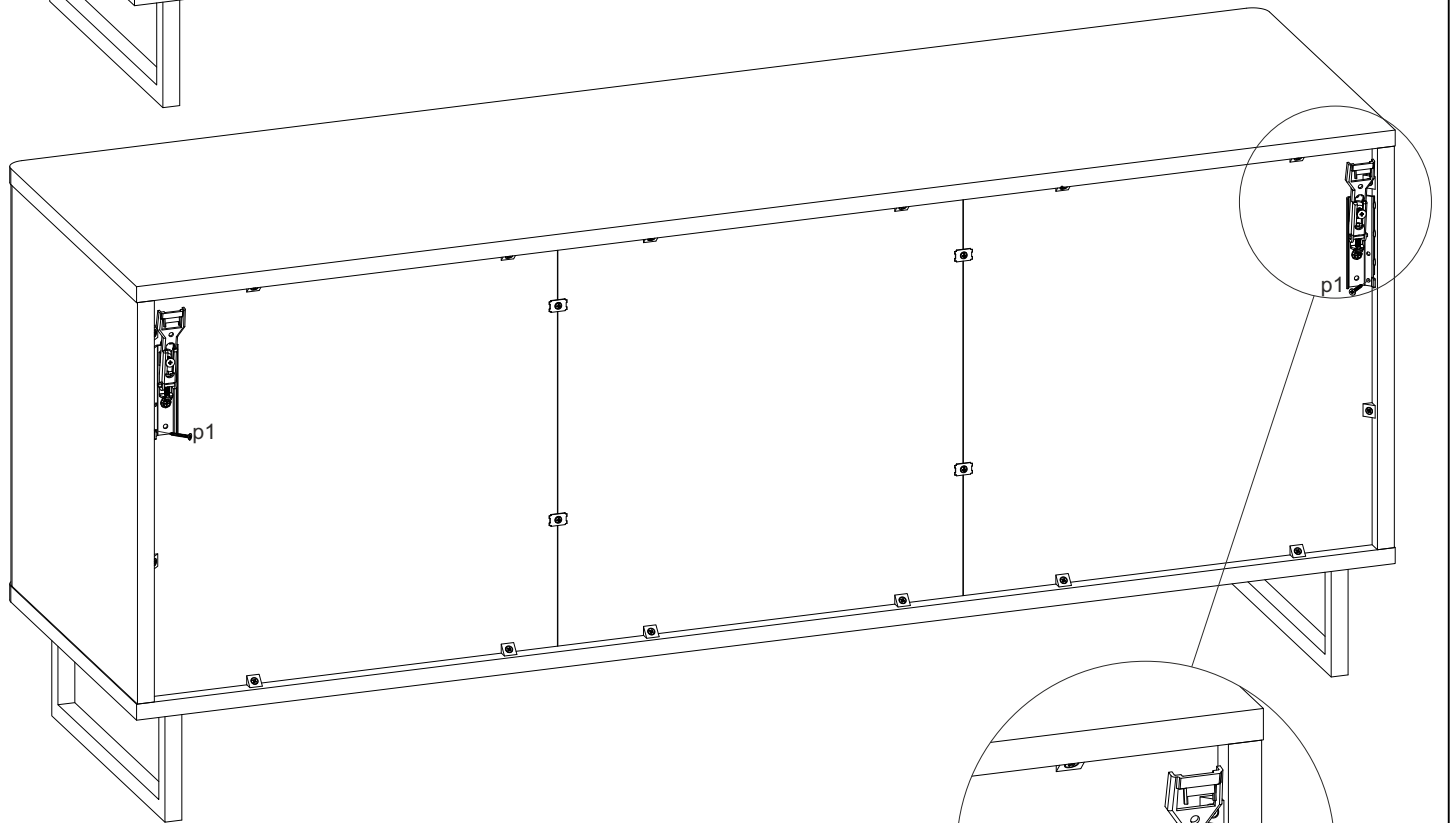
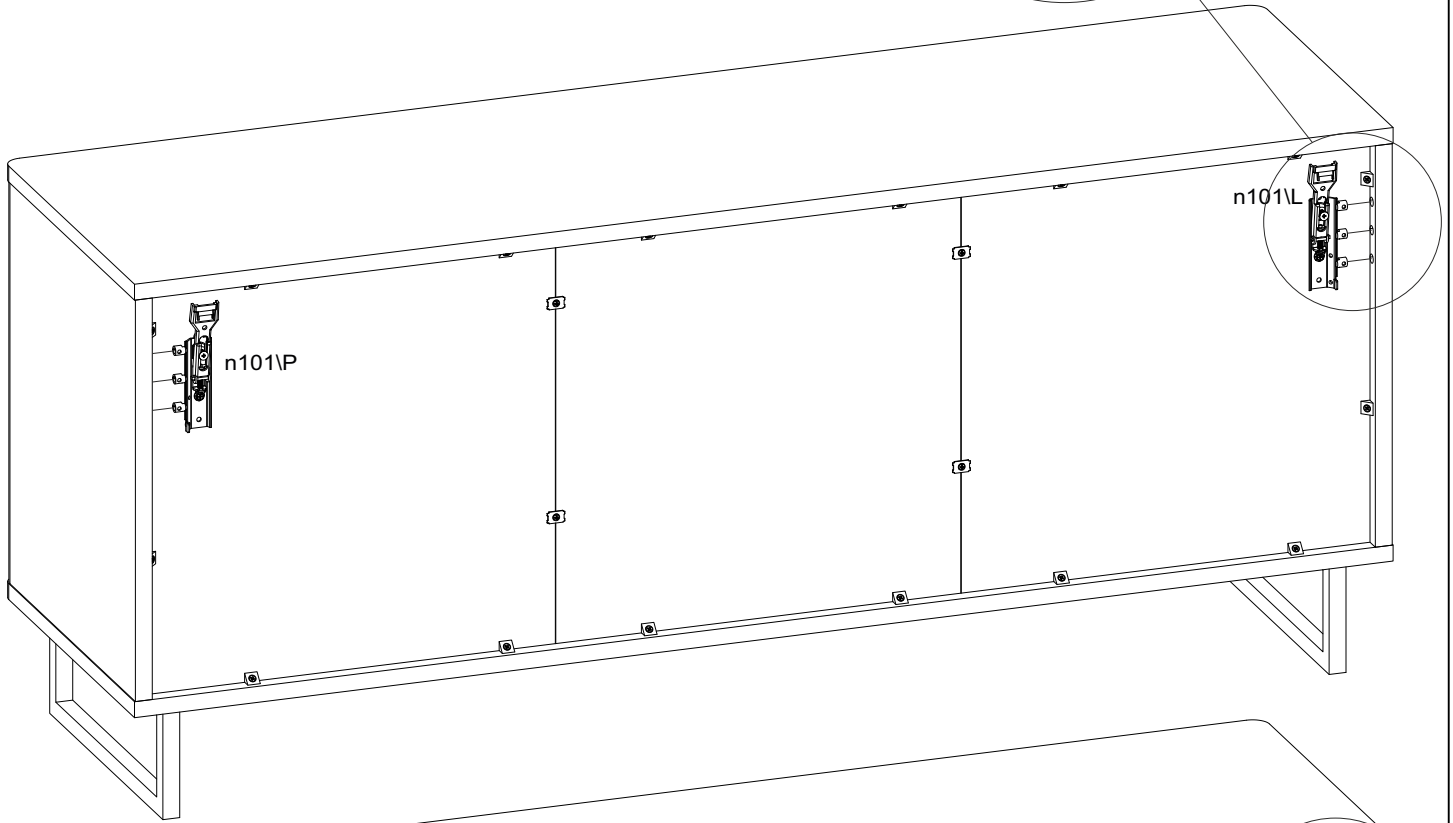
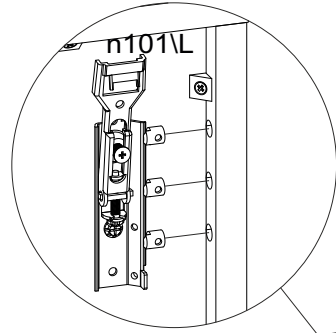



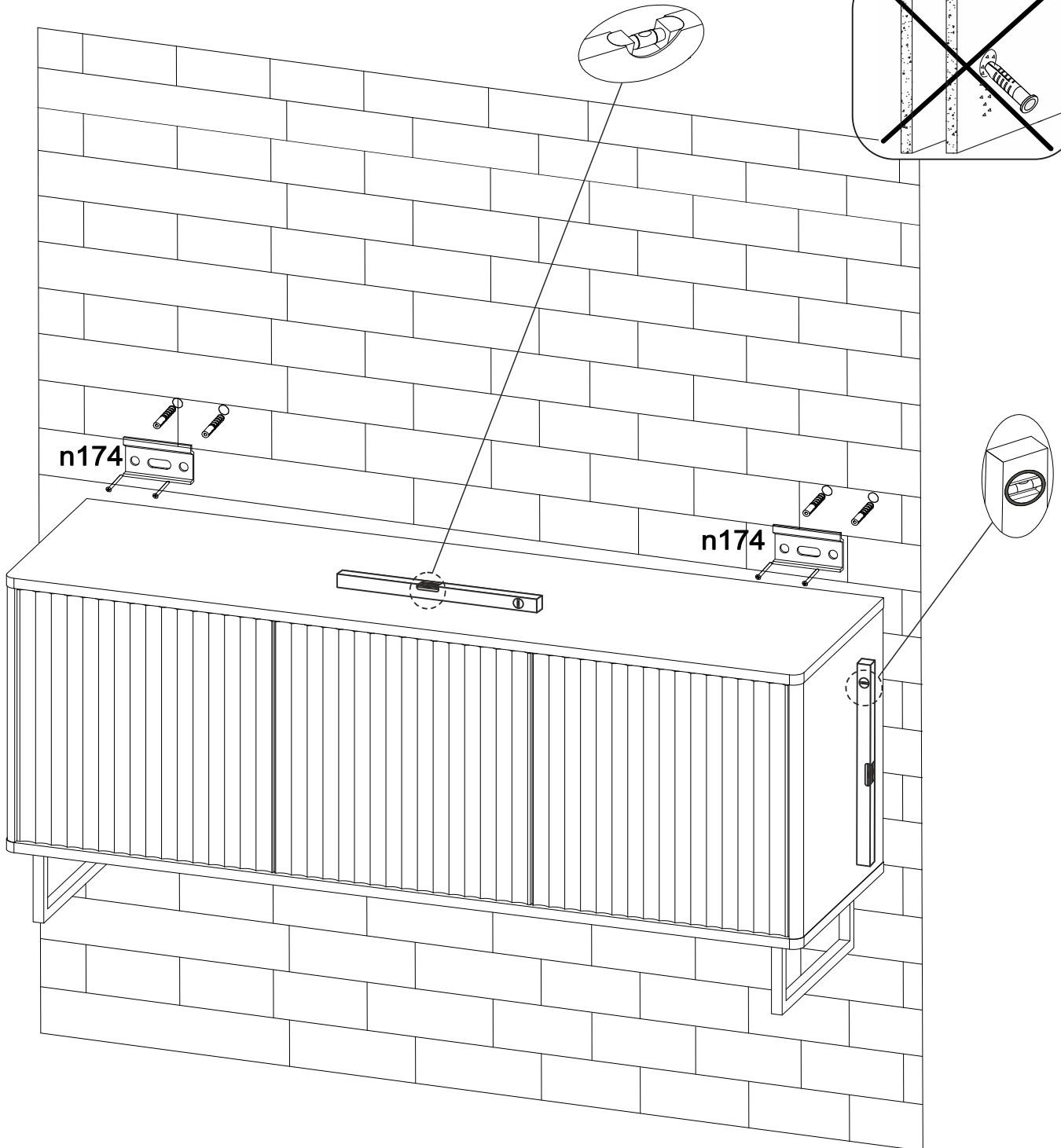
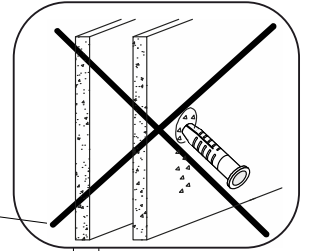
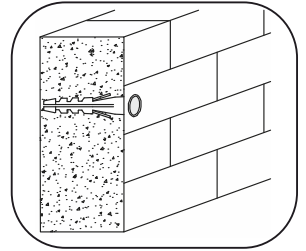
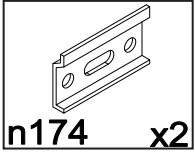





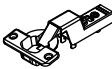











15

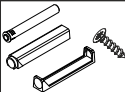

ЧУП «СЕНИРА»

Беларусь, г. Брест, ул. Успенская, 2
т/ф 8 0162 36 46 07 www.senira.by

a1		Петля внутренняя без пружины, крест евровинт	n108		Шайба-скрепка металлическая
a2		Петля полунакладная без пружины, крест евровинт	p38		Шуруп с пресшайбой 3,5x16
b1		Планка петельная	n101		Навес STELS Ch11
d1		Полкодержатель	p1		Шуруп 3x20
f1		Шкант 8x35	n174		Шина для навесков
r1		Стяжка эксцентриковая	f35		Дюбель
r42		Шток стяжки	p17		Шуруп для дюбеля
s2		Заглушка самоклеящаяся	j63		Винт М6
z1		Ключ конфирматный	o68		Шайба под винт М6
p51		Шуруп 3,5x16	n54		Типон + держатель BOYARD или BLUM
l2		Уголок держатель ДВП с шурупом			