

9 - 36 kg

Britax

Römer

EVOLVA 1-2-3 plus

Britax EVOLVA 1-2-3 plus

EVOLVA 1-2-3

Britax EVOLVA 1-2-3

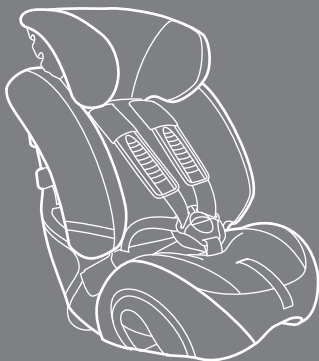

Gebrauchsanleitung



User Instructions



Mode d'emploi



Instrucciones de uso



Manual de instruções



Istruzioni per l'uso



Инструкция по эксплуатации



Brugsvejledning



Gebruiksaanwijzing



Britax Excelsior Limited

1 Churchill Way West t +44 (0)1264 333343
Andover f +44 (0)1264 334146
Hampshire SP10 3UW e helpline@uk.britaxeurope.com
United Kingdom www.britax.eu

BRITAX RÖMER

Kindersicherheit GmbH t +49 (0)731 9345 0
Blaubeurer Straße 71 f +49 (0)731 9345 210
89077 Ulm e info@de.britaxeurope.com
Deutschland www.roemer.eu

- PL** Wyślemy Państwu chętnie niniejszą instrukcję obsługi w języku polskim. Prosimy zwrócić się pod niżej wymienioną adres.
- BG** С удоволствие ще Ви изпратим това ръководство и на немски BG. Моля обърнете се на горепосочения адрес.
- CZ** Rádi Vám tento návod zašleme v českém jazyce. Obrát'te se prosím na níže uvedenou adresu.
- RO** V trimitem aceste instructiuni i n limba RO. V rugm s ne contactai la adresa de mai sus.
- SK** Radi Vám pošleme tento návod k použitiu i v slovenskom jazyku. Obrát'te sa prosím na dole uvedenú adresu.
- TR** Size memnuniyetle bu talimatnameyi türkçe dilinde de göndeririz. Lütfen aşağı da belirtilen adrese başvurunuz.
- H** A leirást szívesen megküldjük Önnek magyar nyelven is. Kérjük, szíveskedjen a lenti címhez fordulni.
- EST** Sme saadame teile meelsasti selle juhendi ka eesti keeles. Palun pöörduge eespool toodud adressil.
- SLO** To navodilo Vam radi pošljemo tudi v slovenskem jeziku. Prosimo, da se obrnete na spodnji naslov.
- LV** Mēs o instrukciju Jums labprāt nosūfīsim arī latvie u valodā. Lūdzu, griezieties augstāk norādītajā adresē.
- HR** Rado cemo Vam poslati ovu Uputu i na hrvatskom jeziku. Molimo da se obratite na dolje navedenu adresu.
- LT** Galime atsiųsti instrukciją ir lietuvių kalba. Prašom kreiptis aukščiau nurodytu adresu.
- S** Vi skickar dig gärna denna anvisning även på svenska. Var god vänd dig till nedanstående adress.
- GR** Μπορούμε να σας στείλουμε τις οδηγίες και στα Ελληνικά. Επικοινωνήστε με την ανωτέρω διεύθυνση.
- N** Vi sender deg gjerne denne veiledningen på norsk. Du kan henvende deg til adressen nedenfor.
- FIN** Lähetämme sinulle nämä ohjeet mielellämme myös Suome en kielellä. Ota yhteyts allamainittuun osoitteeseen.



EVOLVA 1-2-3 EVOLVA 1-2-3 plus

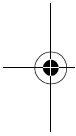

1

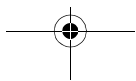

Gebrauchsanleitung

Gebrauchsanleitung

Wir freuen uns, dass unser EVOLVA 1-2-3 Ihr Kind sicher durch einen neuen Lebensabschnitt begleiten darf.

Um Ihr Kind richtig schützen zu können, muss der EVOLVA 1-2-3 unbedingt so verwendet und eingebaut werden, wie wir es Ihnen in dieser Anleitung beschreiben.

Wenn Sie noch Fragen zur Benutzung haben, wenden Sie sich bitte an uns.

Britax Excelsior Ltd.

Inhalt

1. Eignung	5
2. Verwendung im Fahrzeug	9
3. Wichtige Hinweise	13
4. Verwendung des Auto-Kindersitzes für Kinder mit 9 - 18 kg Körpergewicht	17
4.1 Anpassen der Schultergurte	17
4.2 Einstellen der Neigung des Auto-Kindersitzes	19
4.3 Einbau im Fahrzeug	19
4.4 So ist Ihr Auto-Kindersitz eingebaut	27

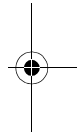

GB

User instructions

User instructions

We are pleased that our EVOLVA 1-2-3 may accompany your child safely through a new stage of his or her life.

In order to protect your child correctly, the EVOLVA 1-2-3 must always be used and installed as described in these instructions.

If you have any further questions regarding its use, please feel free to contact us.

Britax Excelsior Ltd.

Contents

1. Suitability	6
2. Use in the vehicle	10
3. Important notes	14
4. Using the child safety seat for children with a body weight of 9 - 18 kg	18
4.1 Adjusting the shoulder straps	18
4.2 Adjusting the recline of the child safety seat	20
4.3 Installation in the vehicle	20
4.4 Checklist to ensure that your child safety seat is correctly installed	28

F

Mode d'emploi

Mode d'emploi

Nous sommes heureux que notre EVOLVA 1-2-3 puisse accompagner votre enfant en toute sécurité pendant un nouveau chapitre de sa vie.

Pour protéger efficacement votre enfant, le siège EVOLVA 1-2-3 doit impérativement être utilisé et installé de la manière décrite dans le présent mode d'emploi.

Pour toute question complémentaire, n'hésitez pas à nous contacter.

Britax Excelsior Ltd.

Table des matières

1. Habilitation	6
2. Utilisation dans le véhicule	10
3. Remarques importantes	14
4. Utilisation du siège auto pour des enfants de 9 à 18 kg	18
4.1 Adaptation des bretelles	18
4.2 Réglage de l'inclinaison du siège auto	20
4.3 Montage dans le véhicule	20
4.4 Comment savoir si le siège auto est bien monté ?	28



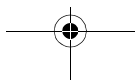
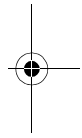
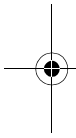

Gebrauchsanleitung

4.5	Lockern der Gurte	29
4.6	Anschnallen Ihres Kindes	31
4.7	Straffen der Gurte	33
4.8	So ist Ihr Kind richtig gesichert	37
5.	Verwendung des Auto-Kindersitzes für Kinder mit 15 - 36 kg Körpergewicht	39
5.1	Ausbau des 5-Punkt-Gurtzeuges	39
5.2	Höhen-Verstellung der Kopfstütze	43
5.3	Einstellen der Neigung des Auto-Kindersitzes	45
5.4	Anschnallen Ihres Kindes	45
5.5	So ist Ihr Kind richtig gesichert	51
6.	EVOLVA 1-2-3 plus : Breiten-Verstellung der Rückenlehne	53
7.	Gebrauch der ausschwenkbaren Getränkehalter	53
8.	Pflegeanleitung	55
8.1	Pflege des Gurtschlosses	57
8.2	Reinigung	61
8.3	Abziehen des Bezuges	63
8.4	EVOLVA 1-2-3 plus: Abziehen des Bezuges	65
8.5	Aufziehen des Bezuges	67
8.6	Einbau der Gurte	67
9.	Hinweise zur Entsorgung	71
10.	2 Jahre Garantie	71
11.	Garantiekarte / Übergabe-Check	78

GB

User instructions

4.5	Loosening the harness	30
4.6	Securing your child	32
4.7	Tightening the harness	34
4.8	Checklist to ensure that your child is buckled up correctly	38
5.	Using the child safety seat for children with a body weight of 15 - 36 kg	40
5.1	Removing the 5-point harness	40
5.2	Adjusting the height of the headrest	44
5.3	Adjusting the recline of the child safety seat	46
5.4	Securing your child	46
5.5	Checklist to ensure that your child is buckled up correctly	52
6.	EVOLVA 1-2-3 plus : Adjusting the width of the backrest	54
7.	Using the fold-out drink holder	54
8.	Care instructions	56
8.1	Care for the harness buckle	58
8.2	Cleaning	62
8.3	Removing the cover	64
8.4	EVOLVA 1-2-3 plus: Removing the cover	66
8.5	Re-fitting the cover	68
8.6	Installing the harness	68
9.	Notes regarding disposal	72
10.	2-year warranty	72
11.	Warranty Card / Transfer Check	80

F

Mode d'emploi

4.5	Desserrage des sangles	30
4.6	Attacher votre enfant	32
4.7	Serrage des sangles	34
4.8	Voici comment votre enfant est bien protégé	38
5.	Utilisation du siège auto pour des enfants de 15 à 36 kg	40
5.1	Démontage du harnais à 5 points	40
5.2	Réglage en hauteur de l'appui-tête	44
5.3	Réglage de l'inclinaison du siège auto	46
5.4	Attacher votre enfant	46
5.5	Voici comment votre enfant est bien protégé	52
6.	EVOLVA 1-2-3 plus : réglage de la largeur du dossier	54
7.	Utilisation des porte-gobelets pivotants	54
8.	Consignes d'entretien	56
8.1	Entretien du fermoir de ceinture	58
8.2	Nettoyage	62
8.3	Retrait de la housse	64
8.4	EVOLVA 1-2-3 plus : retrait de la housse	66
8.5	Remise en place de la housse	68
8.6	Montage des sangles	68
9.	Remarques relatives à l'élimination	72
10.	2 ans de garantie	72
11.	Carte de garantie/procès-verbal de remise	82



1. Eignung

Der EVOLVA 1-2-3 ist nach ECE R44/04 als Auto-Kindersitz für die Altersgruppen I und II+III zugelassen.

Um Ihr Kind in jedem Alter optimal schützen zu können, verfügt der EVOLVA 1-2-3 über zwei Gurtsysteme:



Britax Auto-Kindersitz	Prüfung und Zulassung nach ECE* R 44/04	
	Gruppe	Körpergewicht
EVOLVA 1-2-3	I	9 bis 18 kg

*ECE = Europäische Norm für Sicherheitsausrüstung



Kinder mit einem Körpergewicht von weniger als 15 kg müssen im EVOLVA 1-2-3 mit dem eingebauten **5-Punkt-Gurtzeug des Kindersitzes** gesichert werden. Wir empfehlen die Verwendung des 5-Punkt-Gurtzeuges, bis Ihr Kind ein Körpergewicht von 18 kg erreicht hat.



Der EVOLVA 1-2-3 wird mit dem 3-Punkt-Gurt des Fahrzeuges fest im Auto eingebaut.

GB

User instructions

1. Suitability

The EVOLVA 1-2-3 is approved to ECE R44/04 as a child safety seat for age groups I and II+III.

In order to protect your child optimally at various ages, the EVOLVA 1-2-3 has two harness systems:



Britax child safety seat	Tested and certified according to ECE* R 44/04	
	Group	Body weight
EVOLVA 1-2-3	I	9 to 18 kg

*ECE = European Standard for Child Seat Equipment



Children with a body weight of less than 15 kg must be secured in the EVOLVA 1-2-3 with the **child seat's built-in 5-point harness**. We recommend to use the 5-point harness until your child has got a body weight of 18 kg.



The EVOLVA 1-2-3 is installed permanently in the car with the vehicle's 3-point belt.

F

Mode d'emploi

1. Habilitation

Le modèle EVOLVA 1-2-3 est un siège auto répondant aux exigences de la norme ECE R44/04 pour les classes d'âge I et II+III.

Pour protéger votre enfant de manière optimale, quel que soit son âge, le siège EVOLVA 1-2-3 comporte deux systèmes de sangles :



Siège auto Britax	Examen et homologation selon ECE* R 44/04	
	Groupe	Poids
EVOLVA 1-2-3	I	9 à 18 kg

*ECE = norme européenne pour les équipements de sécurité



Les enfants dont le poids est inférieur à 15 kg doivent être sécurisés dans le modèle EVOLVA 1-2-3 avec le **harnais à 5 points intégré** au siège auto. Nous recommandons d'utiliser le harnais à 5 points jusqu'à ce que votre enfant atteigne 18 kg.



Le siège EVOLVA 1-2-3 se monte de manière fixe à l'aide de la ceinture à 3 points du véhicule.





Gebrauchsanleitung



Britax Auto-Kindersitz	Prüfung und Zulassung nach ECE* R 44/04	
	Gruppe	Körpergewicht
EVOLVA 1-2-3	II+III	15 bis 36 kg

*ECE = Europäische Norm für Sicherheitsausrüstung



Kinder mit einem Körpergewicht von mehr als 18 kg müssen im EVOLVA 1-2-3 mit dem **3-Punkt-Gurt des Fahrzeuges** gesichert werden.



Der EVOLVA 1-2-3 wird nicht fest im Auto eingebaut. Er wird einfach zusammen mit Ihrem Kind durch dem 3-Punkt-Gurt des Fahrzeuges gesichert.

GB

User instructions



15 - 36 kg

Britax child safety seat	Tested and certified according to ECE* R 44/04	
	Group	Body weight
EVOLVA 1-2-3	II+III	15 to 36 kg

*ECE = European Standard for Child Seat Equipment



Children with a body weight of more than 18 kg must be secured in the EVOLVA 1-2-3 with the **vehicle's 3-point belt**.



The EVOLVA 1-2-3 is not installed permanently in the vehicle. It is simply secured together with your child using the vehicle's 3-point belt.

F

Mode d'emploi



15 - 36 kg

Siège auto Britax	Examen et homologation selon ECE* R 44/04	
	Groupe	Poids
EVOLVA 1-2-3	II+III	15 à 36 kg

*ECE = norme européenne pour les équipements de sécurité



Les enfants dont le poids est supérieur à 18 kg doivent être sécurisés dans le modèle EVOLVA 1-2-3 avec la **ceinture à 3 points du véhicule**.



Le siège EVOLVA 1-2-3 n'est pas monté fixement dans le véhicule. Il est simplement sécurisé, conjointement à votre enfant, au moyen de la ceinture à 3 points de votre véhicule.



15 - 36 kg



Zulassung

- Der Auto-Kindersitz ist ausgelegt, geprüft und zugelassen entsprechend den Anforderungen der europäischen Norm für Kindersicherheits-Einrichtungen (ECE R 44/04). Das Prüfzeichen E (in einem Kreis) und die Zulassungsnummer befinden sich auf dem Zulassungsetikett (Aufkleber am Auto-Kindersitz).
- Die Zulassung erlischt, sobald Sie am Auto-Kindersitz etwas verändern. Änderungen darf ausschließlich der Hersteller vornehmen.
- Der EVOLVA 1-2-3 darf ausschließlich zur Sicherung Ihres Kindes im Fahrzeug verwendet werden. Er eignet sich keinesfalls Zuhause als Sitzgelegenheit oder Spielzeug.

2. Verwendung im Fahrzeug



Gefahr! Wird Ihr Kind im Kindersitz nur mit einem 2-Punkt-Gurt gesichert, kann es dadurch bei einem Unfall schwer verletzt oder sogar getötet werden.

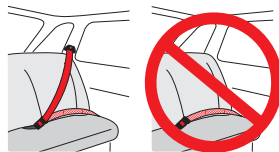

GB

User instructions

Certification

- The child safety seat has been designed, tested and certified to the requirements of the European Standard for Child Safety Seat Equipment (ECE R 44/04). The seal of approval E (in a circle) and the approval number are located on the approval label (sticker on the child seat).
- This approval will be invalidated if you make any modifications to the child safety seat. No modifications may be made to the child safety seat other than by the manufacturer.
- Use the EVOLVA 1-2-3 exclusively for securing your child in your vehicle. It is in no way suitable as a seat or toy in the home.

F

Mode d'emploi

Homologation

- Ce siège auto est conçu, contrôlé et homologué conformément aux exigences de la norme européenne pour les équipements de sécurité pour enfants (ECE R 44/04). Le signe de contrôle E (dans un cercle) et le numéro d'homologation se trouvent sur l'étiquette d'homologation (autocollant sur le siège auto).
- Le siège auto perd son homologation dès que vous réalisez des modifications. Toute modification doit exclusivement être réalisée par le fabricant.
- Le siège EVOLVA 1-2-3 est exclusivement réservé à l'installation sécuritaire de votre enfant dans votre véhicule. Il ne convient en aucun cas à un usage domestique en tant que chaise ou jouet.



2. Use in the vehicle



Danger! If you secure your child in the child seat with only a 2-point belt, then in the event of an accident this may cause serious injuries to your child, possibly resulting in death.

2. Utilisation dans le véhicule



Danger ! Si l'enfant est seulement attaché dans le siège enfant à l'aide d'une ceinture à 2 points, il risque d'être gravement blessé, voire tué, en cas d'accident.



Nie in Verbindung mit einem 2-Punkt-Gurt verwenden!

So können Sie Ihren Auto-Kindersitz verwenden:

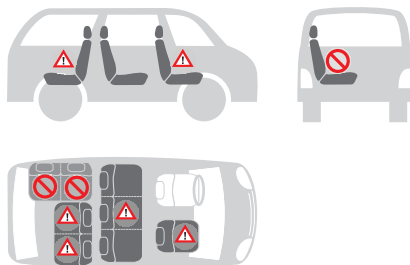

in Fahrtrichtung	ja
entgegen der Fahrtrichtung	nein 1)
mit 2-Punkt-Gurt	nein
mit 3-Punkt-Gurt 2)	ja
auf Beifahrersitz	ja 3)
auf äußeren Rücksitzen	ja
auf mittlerem Rücksitz (mit 3-Punkt-Gurt)	ja 4)

(Bitte beachten Sie die Vorschriften Ihres Landes)

- 1) Verwendung ist nur auf einem rückwärtsgerichteten Fahrzeugsitz (z.B. Van, Minibus) zulässig, der auch für den Transport von Erwachsenen zugelassen ist. Es darf kein Airbag auf den Sitz wirken.
- 2) Der Gurt muss nach ECE R 16 (oder vergleichbarer Norm) genehmigt sein z.B. erkennbar am umrandeten "E", "e" auf dem Prüfetikett am Gurt.
- 3) bei Front-Airbag: Beifahrersitz weit nach hinten schieben, ggf. Hinweis im Fahrzeug-Handbuch beachten.
- 4) Verwendung ist nicht möglich, wenn nur ein 2-Punkt-Gurt vorhanden ist.

GB

User instructions



Never use in combination with a 2-point belt!

You can use your child car seat as follows:

in the direction of travel	yes
against the direction of travel	no 1)
with 2-point belt	no
with 3-point belt 2)	yes
on front passenger seat	yes 3)
on outer rear seat	yes
on centre rear seat (with 3-point belt)	yes 4)

(Please observe the regulations applicable to your particular country)

- 1) Use is permitted on a rearward-facing vehicle seat (e.g. in a van or minibus) only if the vehicle seat is also approved for use by adults. The seat may not be in the area of effect of an airbag.
- 2) The safety belt must be approved to ECE R 16 or a comparable standard (see test label on belt with an "E" or "e" in a circle).
- 3) If there is a front airbag: slide vehicle seat back all the way or nearly so, observe any instructions in vehicle owner's manual.
- 4) Cannot be used if the vehicle seat is equipped with only a 2-point belt.

F

Mode d'emploi



N'utilisez jamais ce siège en association avec une ceinture à 2 points !

Voici comment vous pouvez utiliser le siège auto :

dans le sens de la marche	oui
dans le sens contraire de la marche	non 1)
avec ceinture à 2 points	non
avec ceinture à 3 points 2)	oui
sur le siège passager	oui 3)
sur les sièges arrière latéraux	oui
sur le siège arrière central (avec ceinture à 3 points)	oui 4)

(Veuillez respecter les directives en vigueur dans votre pays)

- 1) L'utilisation sur un siège dirigé dos à la route (p. ex. van, minibus) n'est autorisée que si celui-ci convient également au transport d'adultes. Ce siège ne doit pas être protégé par un airbag.
- 2) La ceinture doit être homologuée selon ECE R 16 (ou une norme comparable), ce qui est par exemple signalé par la lettre « E », « e » insérée dans un cercle et figurant sur l'étiquette de contrôle.
- 3) Avec un airbag frontal : reculez le siège le plus possible. Le cas échéant, respectez les consignes contenues dans le manuel de votre véhicule.
- 4) Utilisation impossible lorsqu'il n'existe qu'une ceinture à 2 points.



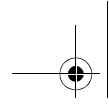

3. Wichtige Hinweise



Zum Schutz Ihres Kindes

- Grundsätzlich gilt: Je enger der Gurt am Körper Ihres Kindes anliegt, desto größer ist die Sicherheit.
- Bitte lassen Sie Ihr Kind im Auto-Kindersitz nie unbeaufsichtigt im Fahrzeug zurück.
- Benutzung auf dem Rücksitz: Stellen Sie den Vordersitz so weit nach vorne, dass Ihr Kind mit den Füßen nicht an der Rückenlehne des Vordersitzes anstößt (Verletzungsgefahr).
- Die Metall- und Kunststoffteile des Kindersitzes heizen sich in der Sonne auf.
Vorsicht! Ihr Kind kann sich daran verbrennen. Schützen Sie den Kindersitz, wenn er gerade nicht gebraucht wird, vor intensiver Sonneneinstrahlung.
- Lassen Sie Ihr Kind nur auf der Gehwegseite ein- und aussteigen.
- Lockern Sie längere Reisen durch Pausen auf, in denen Ihr Kind seinen Bewegungsdrang ausleben kann.

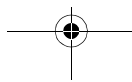
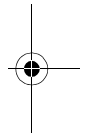
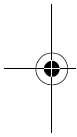

GB

User instructions

3. Important notes



For the protection of your child

- As a general rule: The more snugly the harness fits over your child's body, the safer your child will be.
- Please do not leave your child unattended in the child safety seat in the vehicle.
- Installation on the rear seat: Move the front seat forward far enough that your child's feet cannot hit the backrest of the front seat (to prevent risk of injury).
- The metal and plastic parts of the child safety seat can heat up in the sun.
Caution! Your child may get burnt. Protect the child seat against intense sunlight when it is not actually in use.
- Allow your child to enter and exit the vehicle only on the side away from traffic.
- Make stops during longer journeys to give your child an opportunity to run about and play.

F

Mode d'emploi

3. Remarques importantes



Pour protéger votre enfant

- Les principes suivants sont à respecter : Plus la ceinture est proche du corps de votre enfant, plus celui-ci est en sécurité.
- Ne laissez pas votre enfant dans le siège auto dans la voiture sans surveillance.
- Utilisation sur le siège arrière : avancez le siège avant de manière à ce que les pieds de votre enfant ne touchent pas le dossier de celui-ci (risques de blessures).
- Les parties en métal et en matière plastique du siège auto se réchauffent en plein soleil.
Attention ! Votre enfant risque de se brûler. Protégez le siège auto des rayons du soleil lorsque vous ne l'utilisez pas.
- Ne faites monter ou descendre votre enfant que du côté du trottoir.
- Lors des longs trajets, aménagez des pauses afin que votre enfant puisse se dégourdir les jambes.





Zum Schutz aller Fahrzeuginsassen

Bei einer Notbremsung oder einem Unfall können ungesicherte Gegenstände und Personen andere Mitfahrer verletzen. Bitte achten Sie deshalb stets darauf, dass...

- die Rückenlehnen der Fahrzeugsitze festgestellt sind (z.B. umklappbare Rücksitzbank einrasten).
- im Fahrzeug (z.B. auf der Hutablage) alle schweren oder scharfkantigen Gegenstände gesichert sind.
- alle Personen im Fahrzeug angeschnallt sind.
- der Auto-Kindersitz im Auto immer gesichert ist, auch wenn kein Kind transportiert wird.

Zum Schutz Ihres Fahrzeuges

- An einigen Auto-Sitzbezügen aus empfindlichem Material (z.B. Velours, Leder etc.) können durch die Benutzung von Auto-Kindersitzen Gebrauchsspuren auftreten.

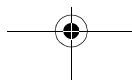
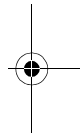
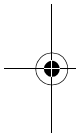

GB

User instructions



For the protection of all vehicle occupants

In the case of an emergency stop or an accident unsecured persons or objects may cause injury to other vehicle occupants. Please always check that...

- The backrests of the vehicle seats are locked (i.e. that a foldable rear seat bench latch is engaged).
- All heavy or sharp-edged objects in the vehicle (e.g. on the parcel shelf) are secured.
- All persons in the vehicle have their seat belts fastened.
- The child safety seat is always secured when it is in the vehicle, even if no child is being transported.

To protect your vehicle

- Some vehicle seat covers of sensitive materials (e.g. velour, leather, etc.) may develop wear marks when child seats are used.

F

Mode d'emploi



Pour protéger tous les passagers

En cas de freinage d'urgence ou d'accident, les objets et personnes non attachés risquent de blesser d'autres passagers. Veuillez donc toujours veiller à ce que...

- les dossiers des sièges du véhicule soient verrouillés (enclenchez par exemple la banquette arrière rabattable),
- tous les objets lourds ou à bords tranchants (par exemple sur la lunette arrière) soient bien fixés,
- toutes les personnes aient mis leur ceinture,
- le siège auto soit toujours fixé dans la voiture même si aucun enfant ne l'occupe.

Pour protéger votre véhicule

- Sur certaines housses de siège de véhicule recouvertes d'une matière délicate (p. ex. velours, cuir, etc.), l'utilisation de sièges auto risque de laisser des traces.



4. Verwendung des Auto-Kindersitzes für Kinder mit 9 - 18 kg Körpergewicht



4.1 Anpassen der Schultergurte

Richtig angepasste Schultergurte geben Ihrem Kind im Auto-Kindersitz optimalen Halt.



Die Schultergurte **2** müssen auf Schulterhöhe Ihres Kindes verlaufen oder etwas darüber.

So können Sie die Höhe der Schultergurte der Körpergröße Ihres Kindes anpassen:

- ✘ Lockern Sie die Gurte so weit wie möglich (siehe 4.5).
 - ✘ Kippen Sie den Gurthöhen-Versteller **1** aus der Rasterung.
 - ✘ Verschieben Sie den Gurthöhen-Versteller **1** in die richtige Schultergurthöhe und rasten Sie ihn ein.
- Vorsicht!** Achten Sie darauf, dass der Kopfstützen-Versteller **8** in seiner untersten Position ist.

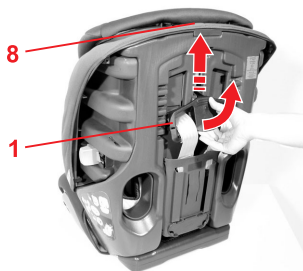
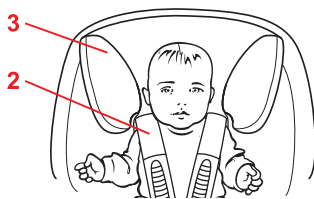

GB

User instructions

4. Using the child safety seat for children with a body weight of 9 - 18 kg



4.1 Adjusting the shoulder straps



Correctly adjusted shoulder straps ensure optimal protection for your child in the safety seat.

The shoulder straps **2** must lie at your child's shoulder level or slightly above.

To adjust the height of the shoulder straps to fit your child:

- ✎ Loosen the harness straps as far as possible (see 4.5).
- ✎ Tilt the shoulder strap adjuster **1** until it disengages.
- ✎ Slide the shoulder strap adjuster **1** until the shoulder pads are at the correct height and reengage.

Caution! Make sure that the headrest adjuster **8** is in its lowest position.

F

Mode d'emploi

4. Utilisation du siège auto pour des enfants de 9 à 18 kg



4.1 Adaptation des bretelles



Les bretelles bien adaptées garantissent que votre enfant est efficacement maintenu dans le siège auto.

Les bretelles **2** doivent se trouver à la hauteur des épaules de votre enfant ou un peu au-dessus.

Pour adapter la hauteur des bretelles à la taille de votre enfant, procédez comme suit :

- ✎ Desserrez les sangles autant que possible (voir le point 4.5).
 - ✎ Faites basculer le dispositif de réglage en hauteur des sangles **1** hors de son logement.
 - ✎ Faites glisser le dispositif de réglage en hauteur des sangles **1** à la bonne hauteur pour les bretelles, puis enclenchez-le dans son logement.
- Attention !** Veillez à ce que le dispositif de réglage de l'appui-tête **8** soit dans sa position la plus basse.



4.2 Einstellen der Neigung des Auto-Kindersitzes



So können Sie den Kindersitz vor dem Einbau im Fahrzeug in zwei Neigungen einstellen:

Tipp! Ist der Autogurt während des Einbaus im Fahrzeug zu kurz, kann es hilfreich sein, wenn der Kindersitz in aufrechter Stellung ist.

- ☞ Schwenken Sie dazu den Abstandskeil **21** nach vorne oder hinten in die gewünschte Stellung.
- **hinten:** zum aufrechten Sitzen
- **vorne:** zum komfortablen Zurücklehnen

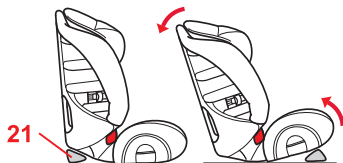

4.3 Einbau im Fahrzeug



So sichern Sie Ihren Kindersitz mit dem 3-Punkt-Gurt Ihres Fahrzeugs:

- ☞ Stellen Sie den Kindersitz in Fahrtrichtung auf den Autositz.
- ☞ Legen Sie den Diagonalgurt **6** zwischen die Kopfstütze und das Seitenteil **18** der Rückenlehne,
Vorsicht! Gurt nicht verdrehen.

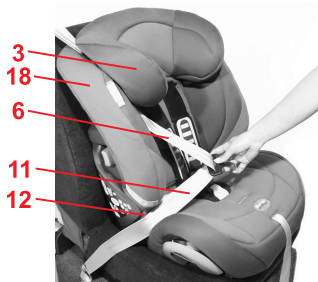

GB

User instructions

4.2 Adjusting the recline of the child safety seat



This is how you can adjust the child seat to two different recline positions before installing it in the vehicle:

Tip! If the vehicle seat belt is too short, it may be helpful to move the child seat to the upright position.

- ✎ The spacer wedge **21** can be moved forward or backward to the desired position.
- **Backward:** to sit upright
- **Forward:** to lean back comfortably

4.3 Installation in the vehicle



To secure the child seat using the 3-point belt of your vehicle proceed as follows:

- ✎ Place the child seat facing forward on the vehicle seat (in the direction of travel).
- ✎ Place the diagonal seat belt section **6** between the headrest and the wing **18** of the backrest, **Caution!** Do not twist the belt.

F

Mode d'emploi

4.2 Réglage de l'inclinaison du siège auto



Pour régler l'une des deux inclinaisons possibles du siège auto avant de le monter dans le véhicule, procédez comme suit :

Astuce ! Lors du montage, il peut s'avérer pratique que la ceinture du véhicule soit trop courte lorsque le siège auto est en position verticale.

- ✎ Basculez la cale **21** vers l'avant ou l'arrière dans la position souhaitée.
- **vers l'arrière :** pour une position verticale
- **vers l'avant :** pour s'adosser confortablement

4.3 Montage dans le véhicule



Pour fixer votre siège auto au moyen de la ceinture à 3 points de votre véhicule, procédez comme suit :

- ✎ Placez le siège auto sur le siège du véhicule en l'orientant vers la route.
- ✎ Glissez la partie diagonale **6** de la ceinture entre l'appui-tête et la partie latérale **18** du dossier. **Attention !** Ne torsadez pas la ceinture.

9 - 18 kg



Gebrauchsanleitung



☞ Legen Sie den Beckengurt **11** in die hellroten Gurtführungen **12**.

Vorsicht! Gurt nicht verdrehen.

☞ Fassen etwa 80 cm des Diagonalgurt**es** **6** und des Beckengurt**es** **11** zusammen.

Vorsicht! Gurt nicht verdrehen.

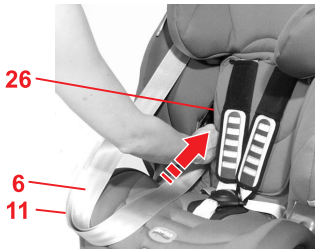

☞ Führen Sie den Autogurt von vorn durch die erste Gurtdurchführung **26** der Rückenlehne.

GB

User instructions

- ✎ Place the lap belt section **11** in the light red belt guides **12**.
Caution! Do not twist the belt.
- ✎ Bring together about 80 cm of the diagonal seat belt section **6** and the lap belt section **11**.
Caution! Do not twist the belt.

F

Mode d'emploi

- ✎ Introduisez la partie ventrale **11** de la ceinture dans les guidages rouge clair **12**.
Attention ! Ne torsadez pas la ceinture.
- ✎ Réunissez les parties diagonale **6** et ventrale **11** de la ceinture sur près de 80 cm.
Attention ! Ne torsadez pas la ceinture.



- ✎ Guide the vehicle seat belt from the front through the first belt path **26** in the backrest.

- ✎ Faites passer la ceinture du véhicule par l'avant au travers du premier guide-ceinture **26** du dossier.

Gebrauchsanleitung

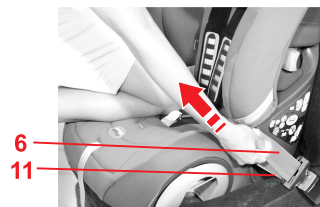
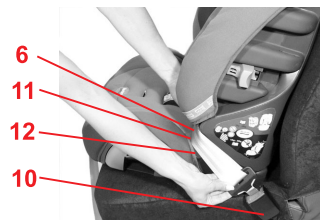
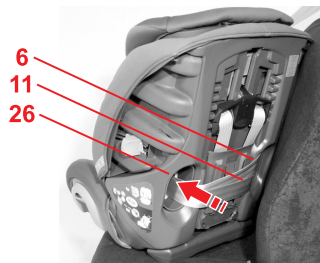

- ☞ Drehen Sie den Kindersitz etwas vom Autositz weg.
- ☞ Führen Sie nun den Autogurt von hinten durch die zweite Gurtdurchführung **26** wieder nach vorn.
Vorsicht! Gurt nicht verdrehen.

- ☞ Legen Sie den Diagonalgurt **6** und Beckengurt **11** auf der Seite des Auto-Gurtschlösses **10** in die Gurtführungen **12** ein.
- ☞ Rasten Sie die Schlosszunge im Auto-Gurtschloss **10** ein. KLICK!

Knien Sie in den Kindersitz und straffen Sie den Autogurt wie folgt:

- ☞ Ziehen Sie am Diagonalgurt **6** zunächst unten am Auto-Gurtschloss, um den Beckengurt **11** zu straffen.

GB

User instructions

- ✎ Turn the child seat away from the vehicle seat slightly.
- ✎ Now guide the vehicle seat belt from back to front through the second belt path **26**.
Caution! Do not twist the belt.
- ✎ Place the diagonal seat belt section **6** and lap belt section **11** on the side of the vehicle seat buckle **10** into the belt guides **12**.
- ✎ Ensure the buckle tongues engage in the vehicle seat buckle **10**. You will hear an audible CLICK!

Using your knee press the child seat, tighten the vehicle seat belt as follows:

- ✎ First pull on the lower part of the diagonal seat belt section **6** near the vehicle seat buckle to tighten the lap belt section **11**.

F

Mode d'emploi

- ✎ Faites pivoter légèrement le siège auto par rapport au siège du véhicule.
- ✎ Faites passer la ceinture du véhicule par l'arrière au travers du deuxième guide-ceinture **26** et ramenez-la vers l'avant.
Attention ! Ne torsadez pas la ceinture.
- ✎ Introduisez les parties diagonale **6** et ventrale **11** de la ceinture sur le côté du fermoir de la ceinture du véhicule **10** dans les guidages **12**.
- ✎ Enclenchez la languette dans le fermoir de la ceinture **10** du véhicule. CLIC !

9 - 18 kg



Gebrauchsanleitung

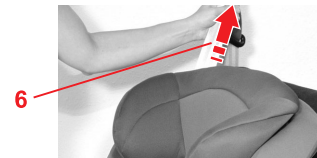

☞ Halten Sie den Diagonalgurt **6** unten fest, und ziehen Sie dann oberhalb der Gurtdurchführung **26** den Diagonalgurt **6** nach vorn, um den losen Gurt durchzuziehen.

☞ Ziehen Sie nun kräftig oben am Diagonalgurt **6**, um den ganzen Autogurt zu straffen.
Vorsicht! Das Auto-Gurtschloss **10** darf auf keinen Fall in der Gurtdurchführung **12** liegen. Ist dies der Fall, versuchen Sie es auf einem anderen Sitzplatz oder versuchen Sie den Kindersitz in der zurückgeneigten Stellung (siehe 4.2) einzubauen.

☞ Vergewissern Sie sich, dass der Kindersitz fest eingebaut ist. Straffen Sie anderenfalls den Autogurt nochmals.
Tipp! Ziehen Sie den Kindersitz am Gurtzeug nach vorn. Er darf sich nur wenig oder garnicht bewegen lassen.

GB

User instructions

- ✎ Holding the lower part of the diagonal seat belt section **6** tight, pull on the diagonal seat belt section **6** above the belt path **26** forward to pull the loose belt through.

- ✎ Then pull firmly on the upper part of the diagonal seat belt section **6** to tighten the entire vehicle seat belt.

Caution! The vehicle seat buckle **10** must not be positioned in the belt guide **12**. If this happens, you may have to try a different seating position or try installing the child seat in the recline position.

- ✎ Make sure that the child seat is securely fastened. If it is not, tighten the vehicle seat belt again.

Tip! Pull forwards on the harness of the child seat. The child seat must move only slightly or not at all.

F

Mode d'emploi

- ✎ Maintenez fermement la partie diagonale **6** de la ceinture en bas, puis tirez au-dessus du guide-ceinture **26** sur la partie diagonale **6** vers l'avant pour bien tendre la ceinture.

- ✎ Tirez avec force sur la partie diagonale **6** de la ceinture vers le haut pour tendre l'ensemble de la ceinture du véhicule.

Attention ! Le fermoir de la ceinture du véhicule **10** ne doit en aucun cas se trouver dans le guidage **12**. Si tel est le cas, essayez sur un autre siège ou tentez de monter le siège auto en position inclinée vers l'arrière (voir 4.2).

- ✎ Assurez-vous que le siège auto est bien fixé. Tendez à nouveau la ceinture du véhicule.

Astuce ! Tirez le siège auto vers l'avant au niveau du harnais. Il ne doit pas bouger du tout ou très peu.

9 - 18 kg



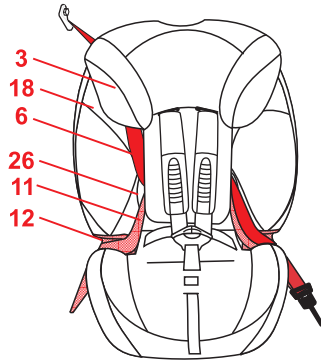

4.4 So ist Ihr Auto-Kindersitz richtig eingebaut



Prüfen Sie zur Sicherheit Ihres Kindes, dass...

- der Auto-Kindersitz fest im Fahrzeug eingebaut ist,
- der Autogurt straff und nicht verdreht ist,
- der Beckengurt **11** durch die beiden hellroten Gurtführungen **12** verläuft,
- der Diagonalgurt **6** auf der dem Auto-Gurtschloss **10** gegenüber liegenden Seite, zwischen dem Seitenteil **18** und der Kopfstütze **3** verläuft,
- die Schlosszunge und das Auto-Gurtschloss **10** **nicht** in den hellroten Gurtführungen **12** des Auto-Kindersitzes liegen,

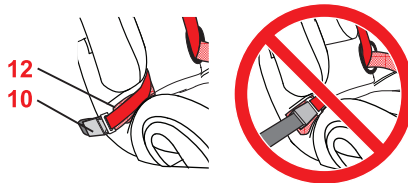

GB

User instructions

4.4 Checklist to ensure that your child safety seat is correctly installed



For the safety of your child, please check that...

- The child seat is securely fastened in the vehicle,
- The vehicle seat belt is tightened up and not twisted,
- The lap belt section **11** runs through both light red belt guides **12**,
- The diagonal seat belt section **6** on the opposite side from the vehicle seat buckle **10** runs between the wing **18** and the headrest **3**,
- **Neither** the buckle tongue nor the vehicle seat buckle **10** are positioned in the light red belt guides **12** of the child seat,

F

Mode d'emploi

4.4 Comment savoir si le siège auto est bien monté ?



Vérifiez, pour la protection de votre enfant, que...

- le siège auto est bien fixé dans le véhicule,
- la ceinture du véhicule est bien tendue et n'est pas torsadée,
- la partie ventrale de la ceinture **11** passe bien par les deux guides-ceinture rouge clair **12**,
- la partie diagonale de la ceinture **6** passe sur le côté du fermoir de la ceinture du véhicule **10**, entre la partie latérale **18** et l'appui-tête **3**,
- la languette et le fermoir de la ceinture du véhicule **10** **ne se trouvent pas** dans les guidages rouge clair **12** du siège auto,

9 - 18 kg



Gebrauchsanleitung

- der Beckengurt **11** und der Diagonalgurt **6** durch die Gurtdurchführungen **26** der Rückenlehne verlaufen.

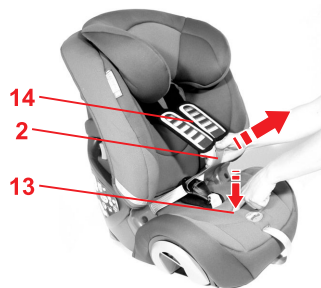
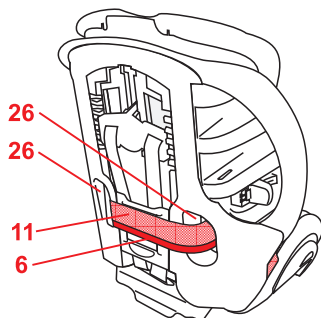

4.5 Lockern der Gurte

- ☞ Drücken Sie auf die Verstelltaste **13** und ziehen Sie gleichzeitig die beiden Schultergurte **2** nach vorne.

Vorsicht! Nicht an den Schulterpolstern **14** ziehen.

GB

User instructions

- The lap belt section **11** and the diagonal belt section **6** run through the belt paths **26** of the backrest.

F

Mode d'emploi

- les parties ventrale **11** et diagonale **6** de la ceinture passent au travers des guides-ceinture **26** du dossier.

9 - 18 kg

4.5 Loosening the harness

- ✎ Press the adjustment button **13** and at the same time pull both shoulder straps **2** forward.

Caution! Do not pull on the shoulder pads **14**.



4.5 Desserrage des sangles

- ✎ Appuyez sur la touche de réglage **13** et tirez les deux bretelles **2** en même temps vers l'avant.

Attention ! Ne tirez pas sur les épaulières **14**.



4.6 Anschnallen Ihres Kindes

☞ Lockern Sie die Schultergurte **2**
(siehe 4.5).

☞ Öffnen Sie das Gurtschloss **15**
(auf die rote Taste drücken).

☞ Stecken Sie die Schliessungen **16**
in die Haltegummis **26**.

☞ Setzen Sie Ihr Kind in den Kindersitz.

☞ Führen Sie die Schultergurte **2** über
die Schultern Ihres Kindes.

Vorsicht! Schultergurte **2** nicht verdrehen
oder vertauschen.

☞ Führen Sie die beiden Schliessungen **16**
zusammen...

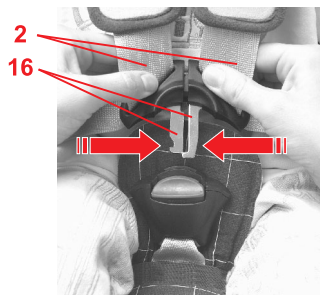
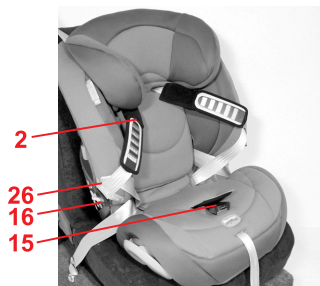

GB

User instructions

4.6 Securing your child

- ✎ Loosen the shoulder straps **2**.
(see 4.5)
- ✎ Open the harness buckle **15** (press the red release button).
- ✎ Insert the buckle tongues **16** into the rubber straps **26**.
- ✎ Place your child into the child seat.
- ✎ Put the shoulder straps **2** over the shoulders of your child.
Caution! Do not twist or interchange the shoulder straps **2**.
- ✎ Put the two buckle tongues **16** together...



F

Mode d'emploi

4.6 Attacher votre enfant

- ✎ Desserrez les bretelles **2**
(voir le point 4.5).
- ✎ Ouvrez le fermoir de la ceinture **15** (appuyez sur la touche rouge).
- ✎ Mettez les languettes **16** dans les bandes en caoutchouc **26**.
- ✎ Asseyez votre enfant dans le siège auto.
- ✎ Passez les bretelles **2** sur les épaules de votre enfant.
Attention! Veillez à ne pas torsader ou inverser les bretelles **2**.
- ✎ Rapprochez les deux languettes **16** l'une de l'autre...



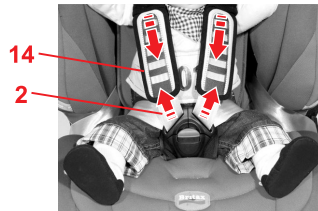
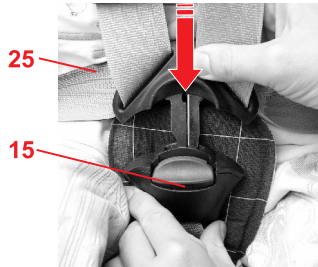

Gebrauchsanleitung

- ☞ ...und rasten Sie sie im Gurtschloss **15** hörbar ein. **KLICK!**
- ☞ Straffen Sie die Gurte, bis sie eng am Körper Ihres Kindes anliegen (siehe 4.7).
Vorsicht! Die Hüftgurte **25** müssen so tief wie möglich über die Leistenbeuge Ihres Kindes verlaufen.

4.7 Straffen der Gurte

- ☞ Ziehen Sie am Verstellgurt **17**, bis das Gurtzeug gleichmäßig und eng am Körper Ihres Kindes anliegt.
Vorsicht! Ziehen Sie den Verstellgurt **17** möglichst gerade heraus und nicht seitlich oder nach oben.
- ☞ Ziehen Sie die Schulterpolster **14** wieder nach unten.
- ☞ Ziehen Sie an den Schultergurten **2**, um sicherzustellen, dass die Hüftgurte **25** straff sind und das Gurtzeug gleichmäßig anliegt.
- ☞ Ziehen Sie nochmals am Verstellgurt **17**, bis das Gurtzeug gleichmäßig und eng am Körper Ihres Kindes anliegt.

GB

User instructions

- ✎ ...and engage in the harness buckle **15** with an audible CLICK!
- ✎ Tighten the straps until they are in contact with your child's body. (see 4.7)
Caution! The hip belt **25** must lie as low as possible over your child's hips.

4.7 Tightening the harness

- ✎ Pull the adjustment strap **17** until the harness lies flat and close to the child's body.
Caution! Pull the adjustment strap **17** straight forward not to the side or upward.
- ✎ Pull shoulder pads **14** down fully.
- ✎ Pull shoulder straps **2** to remove all slack from the lap section ensuring the harness lies flat.
- ✎ Pull the adjustment strap **17** again until the harness lies flat and close to the child's body.

F

Mode d'emploi

- ✎ ...et enclenchez-les dans le fermoir **15** de manière audible. CLIC !
- ✎ Tendez les sangles jusqu'à ce qu'elles soient ajustées aussi près que possible du corps de votre enfant (voir 4.7).
Attention ! Les sangles ventrales **25** doivent passer le plus bas possible, au-dessus de l'aîne de votre enfant.

4.7 Serrage des sangles

- ✎ Tirez sur la sangle de réglage **17**, jusqu'à ce que le harnais exerce un maintien homogène et soit ajusté aussi près que possible du corps de votre enfant.
Attention ! Tirez sur la sangle de réglage **17** le plus horizontalement possible, ni de biais, ni vers le haut.
- ✎ Tirez une nouvelle fois sur les épaulières **14** vers le bas.
- ✎ Tirez sur les bretelles **2**, afin de vous assurer que les sangles ventrales **25** sont tendues et que le harnais exerce un maintien homogène.
- ✎ Tirez à nouveau sur la sangle de réglage **17**, jusqu'à ce que le harnais exerce un maintien homogène et soit ajusté aussi près que possible du corps de votre enfant.

9 - 18 kg



Gebrauchsanleitung

EVOLVA 1-2-3 plus: **Straffen der Gurte mit Click & Safe™**



Click & Safe

☞ Ziehen Sie am Verstellgurt **17**, bis Sie aus der Gurt-Spannungsanzeige **32** ein deutliches Klicken hören.

Tipp! Ziehen Sie den Verstellgurt **17** möglichst gerade heraus und nicht seitlich oder nach oben.

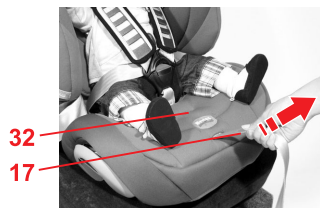

32
17

☞ Ziehen Sie die Schulterpolster **14** wieder nach unten.

☞ Ziehen Sie an den Schultergurten **2**, um sicherzustellen, dass die Hüftgurte **25** straff sind und das Gurtzeug gleichmäßig anliegt.

☞ Ziehen Sie nochmals am Verstellgurt **17**, bis Sie ein Klicken hören.

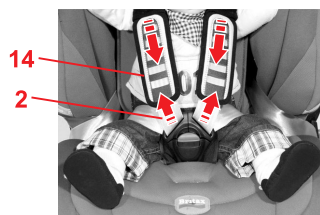

14
2

GB

User instructions

EVOLVA 1-2-3 plus: **Tightening the harness with Click & Safe™**



Click & Safe

- ✎ Pull on the adjustment strap **17** until you hear a clear click from the harness tension indicator **32**.

Tip! Pull the adjustment strap **17** straight forward not to the side or upward.

- ✎ Pull shoulder pads **14** down fully.
- ✎ Pull shoulder straps **2** to remove all slack from the lap section ensuring the harness lies flat.
- ✎ Pull the adjustment strap **17** again until you hear a click.

F

Mode d'emploi

EVOLVA 1-2-3 plus : **serrage des sangles avec Click & Safe™**



Click & Safe

- ✎ Tirez sur la sangle de réglage **17**, jusqu'à ce que l'indicateur de tension du harnais **32** émette un clic sonore.

Astuce ! Tirez sur la sangle de réglage **17** le plus horizontalement possible, ni de biais, ni vers le haut.

- ✎ Tirez une nouvelle fois sur les épaulières **14** vers le bas.
- ✎ Tirez sur les bretelles **2**, afin de vous assurer que les sangles ventrales **25** sont tendues et que le harnais exerce un maintien homogène.
- ✎ Tirez à nouveau sur la sangle de réglage **17**, jusqu'à ce que vous entendiez distinctement un clic.



4.8 So ist Ihr Kind richtig gesichert



Prüfen Sie zur Sicherheit Ihres Kindes, dass...

- die Gurte des Auto-Kindersitzes körpernah anliegen, ohne Ihr Kind einzuengen,
- die Schultergurte **2** richtig eingestellt sind,
- die Gurte **nicht** verdreht sind,
- die Schlosungen **16** im Gurtschloss **15** eingerastet sind,
- die Schulterpolster **14** richtig am Körper anliegen.

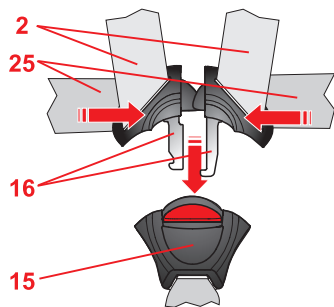

GB

User instructions

4.8 Checklist to ensure that your child is buckled up correctly



For the safety of your child, please check that...

- The straps of the child seat are close to the child's body without constricting the child,
- The shoulder straps **2** are adjusted correctly,
- The straps are **not** twisted,
- The buckle tongues **16** are engaged in the harness buckle **15**,
- The shoulder pads **14** are in the right position on your child's body.

F

Mode d'emploi

4.8 Voici comment votre enfant est bien protégé



Vérifiez, pour la protection de votre enfant, que...

- les sangles du siège auto sont bien ajustées contre le corps de votre enfant, sans le comprimer,
- les bretelles **2** sont correctement ajustées,
- les sangles ne sont **pas** torsadées,
- les languettes **16** sont enclenchées dans le fermoir **15**,
- les épaulières **14** sont bien en contact avec le corps de votre enfant.

9 - 18 kg



5. Verwendung des Auto-Kindersitzes für Kinder mit 15 - 36 kg Körpergewicht



5.1 Ausbau des 5-Punkt-Gurtzeuges

- ✎ Lockern Sie die Gurte so weit wie möglich (siehe 4.5).
- ✎ Schieben Sie den Gurthöhen-Versteller **1** ganz nach oben (siehe 4.1).
- ✎ Hängen Sie die Schultergurte **2** aus dem Verbindungsteil **22** aus.
- ✎ Clipsen Sie das Verbindungsteil **22**, unten an der Rückenlehne **29**, in seine Halterung **30**.
- ✎ Schieben Sie die Gurtschlaufen der Schulterpolster **14** vom Steg **28** der Gurthöhen-Verstellers **1** herunter.
- ✎ Ziehen Sie die Schultergurte **2** und die Gurtschlaufen der Schulterpolster **14** aus den Gurtschlitzten.
- ✎ Öffnen Sie den Klettverschluss am Schrittpolster **23** und nehmen Sie es ab.

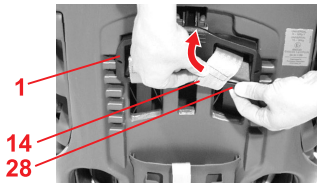
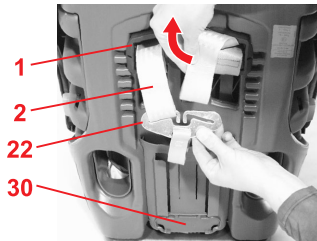

GB

User instructions

5. Using the child safety seat for children with a body weight of 15 - 36 kg



5.1 Removing the 5-point harness

- ✎ Loosen the harness straps as far as possible (see 4.5).
- ✎ Push the shoulder strap adjuster **1** up as far as it will go (see 4.1).
- ✎ Unhook the shoulder straps **2** from the connecting piece **22**.
- ✎ Clip the connecting piece **22** into its retainer **30** at the bottom of the backrest **29**.

- ✎ Unhook the strap loops of the shoulder pads **14** from the retainer arms **28** of the shoulder strap adjuster **1**.
- ✎ Pull the shoulder straps **2** and the strap loops of the shoulder pads **14** out of the belt slots.
- ✎ Undo the Velcro fastener on the crotch cushion **23** and remove it.

F

Mode d'emploi

5. Utilisation du siège auto pour des enfants de 15 à 36 kg



5.1 Démontage du harnais à 5 points

- ✎ Desserrez les sangles autant que possible (voir le point 4.5).
- ✎ Faites glisser le dispositif de réglage en hauteur des sangles **1** complètement vers le haut (voir le point 4.1).
- ✎ Débranchez les bretelles **2** de l'élément de liaison **22**.
- ✎ Enclenchez l'élément de liaison **22** en bas du dossier **29**, dans son dispositif de fixation **30**.

- ✎ Faites descendre les passants des épaulières **14** de la boucle **28** du dispositif de réglage en hauteur des sangles **1**.
- ✎ Retirez les bretelles **2** et les passants des épaulières **14** des fentes pour ceinture.
- ✎ Ouvrez la fermeture velcro du rembourrage de l'entre-jambes **23** et retirez-le.



Gebrauchsanleitung

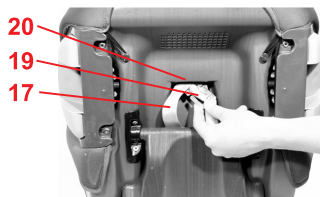

- ✎ Hängen Sie den Verstellgurt **17** aus der Metallplatte **19** aus.
- ✎ Schieben Sie die Metallplatte **19**, mit der das Gurtschloss **15** an der Sitzschale befestigt ist, hochkant durch den Gurtschlitz **20**.
- ✎ Öffnen Sie das Gurtschloss **15**.

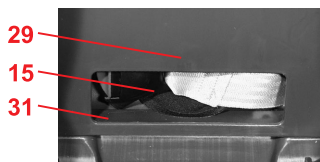

- ✎ Schieben die Gurte mit den Schlosungen **16** durch die Beckengurtschlitz des Bezuges.
- ✎ Legen Sie das Gurtschloss **15** unter den Bezug in das Staufach **31** in der Rückenlehne **29**.

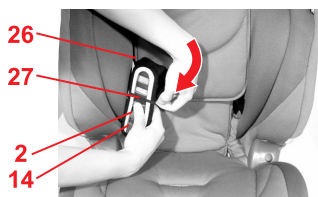

- ✎ Schieben Sie den Verstellgurt **17** unter den Bezug.
- ✎ Befestigen Sie die Schulterpolster **14** und die Schultergurte **2** in den Gummischlaufen **27** an den Gurtdurchführungen **26**.

GB

User instructions

- ✎ Unhook the adjustment strap **17** from the metal plate **19**.
- ✎ Push the metal plate **19** with which the harness buckle **15** is fixed to the seat shell on its side through the belt slot **20**.
- ✎ Open the harness buckle **15**.

- ✎ Push the straps and the buckle tongues **16** through the hip belt slots in the cover.
- ✎ Place the harness buckle **15** under the cover and into the storage compartment **31** in the backrest **29**.

- ✎ Push the adjustment strap **17** under the cover.
- ✎ Fasten the shoulder pads **14** and the shoulder straps **2** in the elastic loops **27** at the belt paths **26**.

F

Mode d'emploi

- ✎ Décrochez la sangle de réglage **17** de la plaque métallique **19**.
- ✎ Poussez la plaque métallique **19**, grâce à laquelle le fermoir **15** est fixé à la coque du siège, en position verticale au travers de la fente pour ceinture **20**.
- ✎ Ouvrez alors le fermoir **15**.

- ✎ Faites passer les sangles et les languettes **16** au travers de la fente pour ceinture ventrale de la housse.
- ✎ Placez le fermoir **15** sous la housse, dans le compartiment de rangement **31** situé dans le dossier **29**.

- ✎ Enfoncez la sangle de réglage **17** sous la housse.
- ✎ Fixez les épaulières **14** et les bretelles **2** dans les passants en caoutchouc **27** au niveau des guides-ceinture **26**.



5.2 Höhen-Verstellung der Kopfstütze

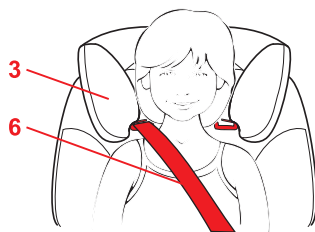

Eine richtig angepasste Kopfstütze **3** gewährleistet den optimalen Verlauf des Diagonalgurtes **6** und bietet Ihrem Kind den gewünschten Schutz und Komfort. Sie können die Höhe der Kopfstütze **3** in 5 Stellungen einrasten.

- Die Kopfstütze **3** muss so eingestellt sein, dass zwischen den Schultern Ihres Kindes und der Kopfstütze **3** noch zwei Finger breit Platz ist.

So können Sie die Höhe der Kopfstütze 3 der Körpergröße Ihres Kindes anpassen:

- ✎ Verstellen Sie den Gurthöhen-Versteller **1** in seine oberste Position (siehe 4.1).
- ✎ Lassen Sie Ihr Kind im Kindersitz Platz nehmen.
- ✎ Fassen Sie in die Rückseite der Kopfstütze **3** und ziehen Sie den Kopfstützen-Versteller **8** nach oben. Nun ist die Kopfstütze **3** entriegelt.
- ✎ Jetzt können Sie die entriegelte Kopfstütze **3** in die gewünschte Höhe verstellen. Sobald Sie den Kopfstützen-Versteller **8** loslassen, rastet die Kopfstütze **3** ein.

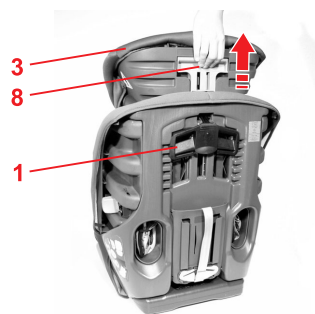

GB

User instructions

5.2 Adjusting the height of the headrest



A correctly adjusted headrest **3** ensures that the diagonal seat belt section **6** is optimally positioned, and gives your child the desired protection and comfort. You can engage the height of the headrest **3** in five positions.

- The headrest **3** must be adjusted so that there is a space two fingers wide between the headrest **3** and your child's shoulders.

To adjust the height of the headrest **3** to fit your child:

- ✎ Move the shoulder strap adjuster **1** to its highest position (see 4.1).
- ✎ Sit your child in the child seat.
- ✎ Reach into the back of the headrest **3** and pull the headrest adjuster **8** upwards. This unlocks the headrest **3**.
- ✎ You can now move the unlocked headrest **3** to the desired height.
As soon as you release the headrest adjuster **8**, the headrest **3** will lock into place.

F

Mode d'emploi

5.2 Réglage en hauteur de l'appui-tête



Un réglage correct de l'appui-tête **3** garantit le positionnement optimal de la partie diagonale de la ceinture **6** et offre à votre enfant la protection et le confort souhaités. Vous pouvez enclencher la hauteur de l'appui-tête **3** dans 5 positions différentes :

- L'appui-tête **3** doit être réglé de façon à ce que l'on puisse passer deux doigts entre les épaules de votre enfant et l'appui-tête **3**.

Pour adapter la hauteur de l'appui-tête **3** à la taille de votre enfant, procédez comme suit :

- ✎ Placez le dispositif de réglage en hauteur des sangles **1** dans sa position la plus haute (voir 4.1).
- ✎ Faites asseoir votre enfant dans le siège auto.
- ✎ Placez votre main à l'arrière de l'appui-tête **3**, puis tirez le dispositif de réglage de l'appui-tête **8** vers le haut. L'appui-tête **3** est à présent déverrouillé.

Vous pouvez maintenant régler l'appui-tête déverrouillé **3** à la hauteur souhaitée. Dès que vous relâchez le dispositif de réglage de l'appui-tête **8**, l'appui-tête **3** se bloque.



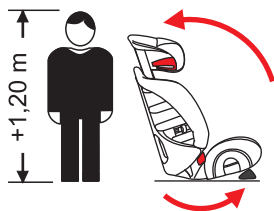

Gebrauchsanleitung

5.3 Einstellen der Neigung des Auto-Kindersitzes

Sie können den Kindersitz wie in 4.2 beschrieben in zwei Neigungen einstellen.



Vorsicht! Für Kinder über 1,20 m Körpergröße darf der EVOLVA 1-2-3 nur in zurückgeneigter Stellung verwendet werden mit dem Abstandskeil **21** vorn.



5.4 Anschnallen Ihres Kindes

So sichern Sie Ihr Kind und den Kindersitz mit dem 3-Punkt-Gurt Ihres Fahrzeugs:

1. Autogurt anlegen

☞ Stellen Sie den Kindersitz auf den Fahrzeugsitz.

Vorsicht! Verwenden Sie den Kindersitz bei Kindern über 1,20 m nur in zurückgeneigter Stellung mit dem Abstandskeil **21** vorn (siehe 5.3).



GB

User instructions

5.3 Adjusting the recline of the child safety seat

You can adjust the child seat to two different recline positions as described in 4.2.



Caution! For children with a standing height over 1.20 m the EVOLVA 1-2-3 may only be used in the reclined position with spacer wedge **21** forward.



5.4 Securing your child

To secure your child and the child seat using the 3-point belt of your vehicle proceed as follows:

1. Fasten the vehicle seat belt

☞ Place the child seat on the vehicle seat.

Caution! For children over 1.20 m, use the child seat only in the reclined position with spacer wedge **21** forward (see 5.3).



F

Mode d'emploi

5.3 Réglage de l'inclinaison du siège auto

Vous pouvez régler le siège auto selon deux inclinaisons, comme indiqué au point 4.2.



Attention ! Pour les enfants mesurant plus d'1,20 m, le siège EVOLVA 1-2-3 ne doit être utilisé qu'en position inclinée, avec la cale **21** placée à l'avant.



5.4 Attacher votre enfant

Pour attacher votre enfant et le siège auto au moyen de la ceinture à 3 points de votre véhicule, procédez comme suit :

1. Positionnez la ceinture.

☞ Placez le siège auto sur le siège du véhicule.

Attention ! Si votre enfant mesure plus d'1,20 m, utilisez uniquement ce siège auto en position inclinée, avec la cale **21** placée à l'avant (voir 5.3).



Gebrauchsanleitung

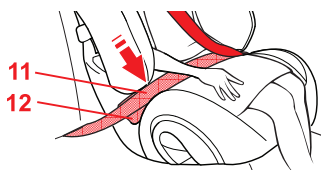
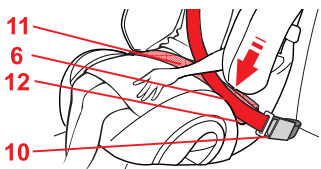
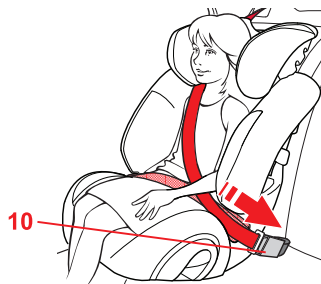

- ☞ Lassen Sie Ihr Kind im Kindersitz Platz nehmen.
- ☞ Ziehen Sie den Autogurt heraus und führen Sie ihn vor Ihrem Kind zum Auto-Gurtschloss **10**.
Vorsicht! Gurt nicht verdrehen.
- ☞ Rasten Sie die Schlosszunge im Auto-Gurtschloss **10** ein. KLICK!

2. Autogurt in die roten Gurtführungen am Kindersitz einlegen.

- ☞ Legen Sie den Diagonalgurt **6** und den Beckengurt **11** auf der Seite des Auto-Gurtschlusses **10** in die hellrote Gurtführung **12**.
Vorsicht! Das Auto-Gurtschloss **10** darf nicht auf der hellroten Gurtführung **12** liegen.
- ☞ Legen Sie den Beckengurt **11** auf der anderen Seite ebenfalls in die hellrote Gurtführung **12**.
Vorsicht! Der Beckengurt **11** muss auf beiden Seiten so tief wie möglich über die Leistenbeuge Ihres Kindes verlaufen.

GB

User instructions

- ✎ Sit your child in the child seat.
- ✎ Pull out the vehicle seat belt and guide it in front of your child to the vehicle seat buckle **10**.
Caution! Do not twist the belt.
- ✎ Engage the buckle tongue in the vehicle seat buckle **10**. You will hear an audible CLICK!

2. Place the vehicle seat belt in the red belt guides on the child seat.

- ✎ Place the diagonal seat belt section **6** and lap belt section **11** on the side of the vehicle seat buckle **10** into the light red belt guide **12**.
Caution! The vehicle seat buckle **10** must not be positioned in the light red belt guide **12**.
- ✎ Also place the lap belt section **11** on the other side in the light red belt guide **12**.
Caution! The lap belt section **11** must lie as low as possible over your child's hips on both sides.

F

Mode d'emploi

- ✎ Faites asseoir votre enfant dans le siège auto.
- ✎ Tirez sur la ceinture et passez-la devant votre enfant jusqu'au fermoir de la ceinture de votre véhicule **10**.
Attention ! Ne torsadez pas la ceinture.
- ✎ Enclenchez la languette dans le fermoir de la ceinture **10** du véhicule. CLIC !

2. Passez la ceinture du véhicule dans les guides-ceinture rouges du siège auto.

- ✎ Introduisez les parties diagonale **6** et ventrale **11** de la ceinture sur le côté du fermoir de la ceinture du véhicule **10** dans le guidage rouge clair **12**.
Attention ! Le fermoir de la ceinture du véhicule **10** ne doit pas se trouver sur le guidage rouge clair **12**.
- ✎ Introduisez la partie ventrale de la ceinture **11** dans le guidage de ceinture rouge clair **12** situé de l'autre côté.
Attention ! Des deux côtés, la partie ventrale de la ceinture **11** doit passer le plus bas possible, au-dessus de l'aîne de votre enfant.

15 - 36 kg



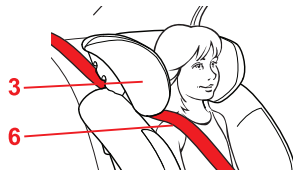
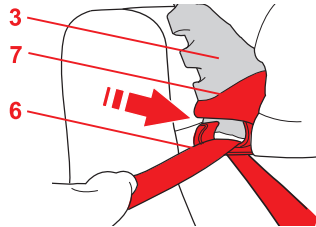

Gebrauchsanleitung

- ✚ Führen Sie den Diagonalgurt **6** in den dunkelroten Gurthalter **7** der Kopfstütze **3** ein, bis er vollständig und unverdreht in Gurthalter **7** liegt.

- ✚ Vergewissern Sie sich, dass der Diagonalgurt **6** über das Schlüsselbein Ihres Kindes läuft und nicht am Hals anliegt.
Tipp! Sie können die Kopfstütze **3** auch noch im Fahrzeug in der Höhe anpassen.
- ✚ **Vorsicht!** Der Diagonalgurt **6** muss schräg nach hinten verlaufen.
Tipp! Sie können den Gurtverlauf mit dem verstellbaren Gurtumlenker Ihres Fahrzeuges regulieren.
- ✚ **Vorsicht!** Der Diagonalgurt **6** darf nie nach vorn zum Gurtumlenker am Auto führen.
Tipp! Versuchen Sie in diesem Fall einen anderen Sitzplatz auf dem Rücksitz.
- ✚ Straffen Sie den Autogurt, indem Sie am Diagonalgurt **6** ziehen.

GB

User instructions

- ✎ Guide the diagonal seat belt section **6** into the dark red belt holder **7** of the headrest **3** until it lies completely in the belt holder and is not twisted **7**.

- ✎ Make sure that the diagonal seat belt section **6** runs over your child's shoulder, and not in front of his or her neck.
Tip! You can adjust the height of the headrest **3** in the vehicle.
- ✎ **Caution!** The diagonal seat belt section **6** must run slanted towards the back.
Tip! You can adjust the course of the belt with your vehicle's upper seat belt anchorage point.
- ✎ **Caution!** The diagonal seat belt section **6** must never lead forward to the vehicle's upper seat belt anchorage point.
Tip! In this case, try a seating position on the rear seats.
- ✎ Tighten the vehicle seat belt by pulling on the diagonal seat belt section **6**.

F

Mode d'emploi

- ✎ Insérez la partie diagonale **6** de la ceinture dans le support de sangle rouge foncé **7** de l'appui-tête **3**, jusqu'à ce qu'elle repose complètement dans le support de sangle **7** sans être torsadée.

- ✎ Vérifiez que la partie diagonale **6** de la ceinture passe sur la clavicle de votre enfant et non sur son cou.
Astuce ! Vous pouvez maintenant régler l'appui-tête **3** du véhicule à la hauteur souhaitée.
- ✎ **Attention !** La partie diagonale **6** de la ceinture doit être positionnée en biais vers l'arrière.
Astuce ! Vous pouvez modifier la direction de la ceinture à l'aide du dispositif de réglage de la ceinture de votre véhicule.
- ✎ **Attention !** La partie diagonale **6** de la ceinture ne doit jamais être dirigée vers l'avant en direction du dispositif de réglage de la ceinture du véhicule.
Astuce ! Dans le cas contraire, tentez d'installer le siège auto sur un autre siège à l'arrière.
- ✎ Tendez la ceinture du véhicule en tirant sur la partie diagonale **6**.

15 - 36 kg



5.5 So ist Ihr Kind richtig gesichert

⚠ Prüfen Sie zur Sicherheit Ihres Kindes, dass...

- der Beckengurt **11** auf beiden Seiten in den hellroten Gurtführungen **12** verläuft,
 - der Diagonalgurt **6** auf der Seite des Auto-Gurtschlusses **10** ebenfalls in der hellroten Gurtführung **12** verläuft,
 - der Diagonalgurt **6** durch den dunkelroten Gurthalter **7** der Kopfstütze **3** verläuft,
 - der Diagonalgurt **6** schräg nach hinten verläuft,
 - die Gurte gestrafft und nicht verdreht sind,
-
- das Auto-Gurtschloss **10** nicht auf der hellroten Gurtführung **12** oder der Sitzschale liegt.

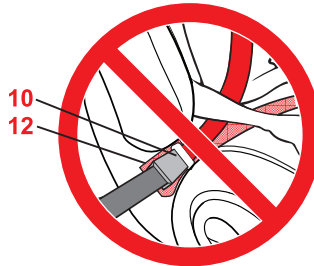
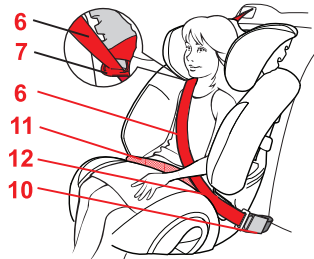

GB

User instructions

5.5 Checklist to ensure that your child is buckled up correctly



For the safety of your child, please check that...



- The lap belt section **11** runs through the light red belt guides **12** on both sides,
- The diagonal seat belt section **6** on the side of the vehicle seat buckle **10** also runs through the light red belt guide **12**,
- The diagonal seat belt section **6** runs through the dark red belt holder **7** of the headrest **3**,
- The diagonal seat belt section **6** runs diagonally backward,
- The straps are tight and not twisted,
- The vehicle seat buckle **10** is not positioned on the light red belt guide **12** or the seat shell.

F

Mode d'emploi

5.5 Voici comment votre enfant est bien protégé



Vérifiez, pour la protection de votre enfant, que...



- la partie ventrale **11** de la ceinture passe bien de part et d'autre par les guides-ceinture rouge clair **12**,
- la partie diagonale **6** de la ceinture passe également sur le côté du fermoir de la ceinture du véhicule **10** dans le guidage rouge clair **12**,
- la partie diagonale **6** de la ceinture traverse bien le support de sangle rouge foncé **7** de l'appui-tête **3**,
- la partie diagonale **6** de la ceinture est dirigée en biais vers l'arrière,
- les ceintures sont tendues et non torsadées,
- le fermoir de la ceinture du véhicule **10** ne repose pas sur le guidage rouge clair **12** ou la coque du siège.



15 - 36 kg



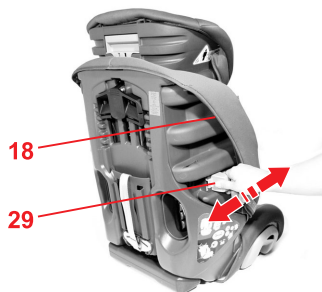

6. EVOLVA 1-2-3 plus : Breiten-Verstellung der Rückenlehne

Sie können die Rückenlehne **29** beim Evolva 1-2-3 plus **in der Breite einstellen**.

☞ Schieben Sie beide hellgrauen Breiten-Versteller **24** an der Außenseite der Seitenteile **18** vor oder zurück in die gewünschte Stellung.

- **zurück:** der Sitz wird breiter
- **vor:** der Sitz wird schmaler

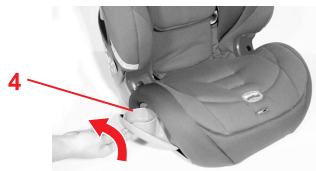

7. Gebrauch der ausschwenkbaren Getränkehalter

Vorsicht! Um Verletzungen vorzubeugen, verwenden Sie die Ablagen bitte nie für...

- heiße Flüssigkeiten
- scharfe oder spitze Gegenstände (z. B. Bleistifte)
- harte und schwere Gegenstände (z. B. Alu-Trinkflaschen)

☞ Schwenken Sie den Getränkehalter **4** nach oben und außen, bis er einrastet.

GB

User instructions

6. EVOLVA 1-2-3 plus : Adjusting the width of the backrest

You can adjust the width of the backrest **29** on the Evolva 1-2-3 plus.

- ☞ Push the two light grey width adjusters **24** on the outside of the wings **18** forward or backward to the desired position
- **Backward**: makes the seat wider
 - **Forward**: makes the seat narrower

7. Using the fold-out drink holder

Caution! In order to prevent injury, never use the trays for...

- Hot liquids
- Sharp or pointed objects (e.g. pencils)
- Hard or heavy objects (e.g. aluminium drink cans)

- ☞ Swivel the drink holder **4** upwards and outwards until it engages.

F

Mode d'emploi

6. EVOLVA 1-2-3 plus : réglage de la largeur du dossier

Vous avez la possibilité de régler la largeur du dossier **29** du siège Evolva 1-2-3 plus.

- ☞ Poussez les deux dispositifs de réglage de la largeur **24** gris clair situés à l'extérieur des parties latérales **18** vers l'avant ou l'arrière jusqu'à la position souhaitée.
- **vers l'arrière** : le siège s'élargit
 - **vers l'avant** : le siège devient plus étroit

7. Utilisation des porte-gobelets pivotants

Attention ! Afin d'éviter toute blessure, n'utilisez jamais ces supports pour...

- des boissons chaudes
- des objets tranchants ou pointus (par ex. des crayons)
- des objets durs et lourds (par ex. des canettes en alu)

- ☞ Faites basculer le porte-gobelet **4** vers le haut ou l'extérieur, jusqu'à ce qu'il s'enclenche.





8. Pflegeanleitung



Zum Erhalt der Schutzwirkung

- Bei einem Unfall mit einer Aufprallgeschwindigkeit über 10 km/h können Beschädigungen am Auto-Kindersitz aufgetreten sein, die nicht unbedingt offensichtlich sind. In diesem Fall muss der Auto-Kindersitz ausgetauscht werden. Bitte entsorgen Sie ihn fachgerecht (siehe 9.).
- Kontrollieren Sie regelmäßig alle wichtigen Teile auf Beschädigungen. Vergewissern Sie sich, dass die mechanischen Bauteile einwandfrei funktionieren.
- Achten Sie darauf, dass der Auto-Kindersitz nicht zwischen harten Teilen (Fahrzeugsitz, Sitzschiene etc.) eingeklemmt und beschädigt wird.
- Lassen Sie einen beschädigten Auto-Kindersitz (z.B. nach einem Sturz) unbedingt vom Hersteller überprüfen.
- Schmieren oder ölen Sie niemals Teile des Kindersitzes.

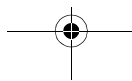
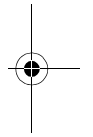
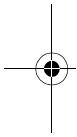

GB

User instructions

8. Care instructions



To retain the protective effect

- In an accident at a collision speed above 10 km/h the child safety seat could suffer damage which is not necessarily obvious. In this case you must replace the child seat. Please dispose of it properly (see 9.).
- Regularly check all important parts for damage. Ensure the correct operation of all mechanical components.
- To prevent damage or breakage, ensure that the child seat does not become jammed in the car door, seat runners, etc.
- Should the child safety seat be damaged (for example after dropping it) it must be inspected by the manufacturer.
- Never oil or grease parts of the child seat.

F

Mode d'emploi

8. Consignes d'entretien



Pour conserver l'efficacité de la protection

- En cas de collision à une vitesse supérieure à 10 km/h, il est possible que le siège auto soit endommagé, les dégâts n'étant pas forcément visibles. Dans ce cas, le siège auto doit être remplacé. Veuillez éliminer l'ancien siège auto de manière appropriée (voir le point 9).
- Contrôlez régulièrement l'état de toutes les pièces importantes. Assurez-vous du bon fonctionnement de toutes les pièces mécaniques.
- Veillez à ce que le siège auto ne soit pas coincé entre des objets durs (porte du véhicule, glissière du siège, etc.), ce qui risquerait de l'endommager.
- Faites impérativement contrôler un siège auto endommagé (par exemple, après une chute) par le fabricant.
- Ne graissez, ni huilez jamais les pièces du siège auto.

D

GB

F



Gebrauchsanleitung



- Bewahren Sie den Kindersitz, wenn er nicht benutzt wird, an einem sicheren Ort auf. Stellen Sie keine schweren Dinge auf ihn. Lagern Sie ihn nie in der Nähe von direkten Hitzequellen oder direktem Sonnenlicht.

8.1 Pflege des Gurtschlosses

Das Funktionieren des Gurtschlosses trägt wesentlich zur Sicherheit bei. Funktionsstörungen am Gurtschloss sind meist auf Verunreinigungen zurückzuführen.

Funktionsstörung

- Die Schloßzungen werden beim Drücken der roten Taste verlangsamt ausgeworfen.
- Die Schloßzungen rasten nicht mehr ein (werden wieder ausgestoßen).
- Die Schloßzungen rasten ohne deutliches "Klick" ein.
- Die Schloßzungen werden beim Einführen gebremst (teigig).
- Das Gurtschloss läßt sich nur noch mit hohem Kraftaufwand öffnen.

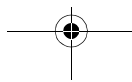
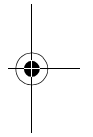
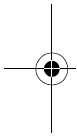

GB

User instructions

- Store the child seat in a safe place when it is not in use. Avoid placing heavy objects on top of it. Do not store it near a direct heat source or direct sunlight.

F

Mode d'emploi

- Conservez le siège auto dans un lieu approprié lorsque vous ne l'utilisez pas. Ne posez aucun objet lourd sur le siège auto. Ne l'entrez jamais à proximité des sources de chaleur ou exposé à la lumière directe du soleil.

8.1 Care for the harness buckle

The function of the harness buckle is important for the safety of your child. Malfunctions of the harness buckle are mostly attributable to accumulations of dirt and dust.

Malfunction

- The buckle tongues are ejected only slowly when the red release button is pressed.
- The buckle tongues will no longer lock (are ejected again).
- The buckle tongues engage without an audible "click".
- The buckle tongues are difficult to insert (you feel resistance).
- The buckle only opens if extreme force is applied.

8.1 Entretien du fermoir de ceinture

Le bon fonctionnement du fermoir contribue de manière essentielle à la sécurité. Dans la plupart des cas, les dysfonctionnements du fermoir sont causés par l'encrassement.

Dysfonctionnements

- L'éjection des languettes est ralentie lors de l'actionnement de la touche rouge.
- Les languettes ne s'enclenchent plus (rejet hors du fermoir).
- Les languettes s'enclenchent sans « clic » audible.
- Les languettes sont freinées lors de l'introduction (impression de blocage pâteux).
- Le fermoir ne peut être ouvert qu'en appliquant une grande force.



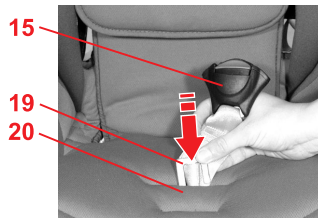

Abhilfemaßnahme

So können Sie das Gurtschloss auswaschen damit es wieder einwandfrei funktioniert:

1. Gurtschloss ausbauen (siehe 5.1)
2. Gurtschloss auswaschen

☞ Legen Sie das Gurtschloss **15** mindestens 1 Stunde in warmes Wasser mit milder Seifenlösung. Spülen Sie es danach aus und lassen Sie es gut trocknen.

3. Gurtschloss einbauen

☞ Schieben Sie die Metallplatte **19** hochkant von oben nach unten durch den Gurtschlitz **20** im Bezug **und durch die Sitzschale**. Ziehen Sie kräftig am Gurtschloss **15** um die **Befestigung zu überprüfen**.

☞ Befestigen Sie das Schrittpolster **23**.

Funktionsstörung

- Die Schlosszungen **16** lassen sich nicht mehr ins Gurtschloss **15** einführen.

Abhilfemaßnahme

☞ Drücken Sie die rote Taste, um das Gurtschloss **15** zu entriegeln.

GB

User instructions

Remedy

Wash the harness buckle so that it functions properly once again:

1. Removing the harness buckle (see 5.1)
2. Cleaning the harness buckle

✎ Soak the buckle **15** in warm water with mild detergent for at least an hour. Rinse and dry thoroughly.

3. Re-fitting the harness buckle

✎ Push the metal plate **19** on its side downwards through the belt slot **20** in the cover **and through the seat shell**.

Check for correct fitting by pulling firmly on the harness buckle **15**.

✎ Attach the crotch cushion **23**.

Malfunction

- The buckle tongues **16** can no longer be inserted into the harness buckle **15**.

Remedy

✎ Press the red button to release the harness buckle **15**.

F

Mode d'emploi

Remèdes

Vous pouvez laver le fermoir pour qu'il fonctionne de nouveau parfaitement :

1. Démontage du fermoir (voir le point 5.1)
2. Lavage du fermoir

✎ Faites tremper le fermoir **15** dans de l'eau chaude savonneuse (savon doux) pendant au moins 1 heure. Rincez-le, puis laissez-le sécher.

3. Remontage du fermoir

✎ Poussez la plaque métallique **19** en position verticale, du haut vers le bas, au travers de la fente pour ceinture **20** dans la housse **et au travers de la coque de siège**.
Tirez fortement sur le fermoir **15** pour **contrôler sa fixation**.

✎ Fixez le rembourrage de l'entre-jambes **23**.

Dysfonctionnement

- Les languettes **16** ne peuvent plus être introduites dans le fermoir **15**.

Remède

✎ Appuyez sur la touche rouge afin de déverrouiller le fermoir **15**.



8.2 Reinigung

Achten Sie darauf, dass Sie nur einen Original-Britax-Ersatzbezug einsetzen, da der Bezug einen wesentlichen Teil der Systemfunktion darstellt. Ersatz erhalten Sie im Fachhandel.

 Der Auto-Kindersitz darf **nicht ohne Bezug** verwendet werden.

- Den **Bezug** können Sie abziehen und mit Feinwaschmittel im Schonwaschgang bei 30°C in der Waschmaschine waschen. Bitte beachten Sie die Anleitung auf dem Waschetikett des Bezuges. Wenn Sie mit mehr als 30 °C waschen, ist ein Ausfärben des Bezugsstoffes möglich. Den Bezug nicht schleudern und auf keinen Fall im elektrischen Wäschetrockner trocknen (der Stoff kann sich von der Polsterung lösen).
- Die **Kunststoffteile** können Sie mit einer Seifenlösung abwaschen. **Keine** scharfen Mittel (wie z.B. Lösungsmittel) verwenden.
- Die **Gurte** können Sie mit einer lauwarmen Seifenlösung abwaschen.
Vorsicht! Entfernen Sie niemals die Schlosszungen **16** von den Gurten.

GB

User instructions

8.2 Cleaning

Use only original Britax replacement covers, as the cover is important to the proper functioning of the system. Replacement covers are available from your retailer.



The child safety seat must **not be used without the seat cover**.

- The **cover** can be removed and washed with a mild detergent using the washing machine's cycle for delicate items (30 °C). Please observe the instructions on the washing label of the cover. The colours of the cover may fade if washed at more than 30 °C. Do not spin, and never tumble dry in an electric clothes dryer (the fabric may separate from the padding).
- The **plastic parts** can be cleaned using soapy water. **Do not** use harsh cleaning agents (such as solvents).
- The **harness** can be wiped clean with lukewarm soapy water.
Caution! Never remove the buckle tongues **16** from the straps.

F

Mode d'emploi

8.2 Nettoyage

Veillez à utiliser uniquement une housse de rechange Britax, car la housse représente un élément fonctionnel essentiel du système. Les housses de rechange sont disponibles dans les magasins spécialisés.



Le siège auto **ne doit pas être utilisé** sans housse.

- La **housse** peut être enlevée et lavée en machine à 30° avec une lessive pour linge délicat. Respectez les instructions de lavage figurant sur l'étiquette de la housse. Si vous lavez la housse à des températures supérieures à 30°, le tissu risque de déteindre. N'essorez pas la housse et ne la mettez en aucun cas dans un sèche-linge (le tissu risque de se décoller du rembourrage).
- Vous pouvez laver les **éléments en matière plastique** à l'eau savonneuse. **N'utilisez pas** de détergents ou de produits corrosifs (des solvants, par exemple).
- Les **sangles** peuvent être lavées à l'eau savonneuse tiède.
Attention ! N'enlevez jamais les languettes **16** des sangles.



Gebrauchsanleitung

- Die **Schulterpolster 23** können Sie ausbauen und mit einer lauwarmen Seifenlösung abwaschen.
Vorsicht! Die Schulterpolster **23** reduzieren das Verletzungsrisiko Ihres Kindes bei einem Unfall. Verwenden Sie den Kindersitz nur mit diesen Schulterpolstern **14**.

8.3 Abziehen des Bezuges

- ☞ Hängen Sie, wie beschrieben (siehe 5.1), das Gurtzeug aus.
- ☞ Verstellen Sie die Kopfstütze **3** ganz nach oben.
- ☞ Hängen Sie die Bezugs-kante und die Gummischlaufen unter dem Rand des Kindersitzes aus.
- ☞ Nehmen Sie den Bezug der Kopfstütze **3** ab.
- ☞ Hängen Sie auf der Sitzunterseite die Gummischlaufen des Bezuges an dem Getränkehalter **4** aus.
- ☞ Stülpen Sie den Bezug mit der Aussparung über die Kopfstütze **3**.

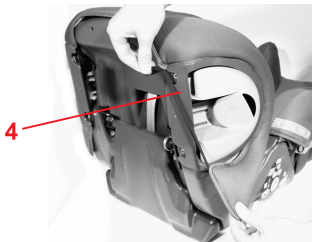

GB

User instructions

- The **shoulder pads 14** can be removed and washed in lukewarm soapy water.
Caution! The shoulder pads **14** reduce the risk of injury to your child in the event of an accident. Use the child seat only with these shoulder pads **14**.

8.3 Removing the cover

- ✎ Unhook the harness as described above (see 5.1).
- ✎ Move the headrest **3** all the way up.
- ✎ Take the seam of the cover and the elastic loops off the hooks under the edge of the child seat.
- ✎ Remove the cover of the headrest **3**.

- ✎ On the underside of the seat, unhook the elastic loops of the cover at the drink holder **4**.
- ✎ Put the cover with the recess over the headrest **3**.

F

Mode d'emploi

- Vous pouvez démonter les **épauières 23** et les laver à l'eau savonneuse tiède.
Attention ! Les épauières **23** réduisent le risque de blessure de votre enfant en cas d'accident. Utilisez toujours ce siège auto avec les épauières **14**.

8.3 Retrait de la housse

- ✎ Décrochez tout d'abord le harnais (voir le point 5.1).
- ✎ Placez l'appui-tête **3** complètement vers le haut.
- ✎ Décrochez les élastiques de la housse et les passants en caoutchouc situés sous le bord de la coque.
- ✎ Retirez la housse de l'appui-tête **3**.

- ✎ Sur la partie inférieure du siège, décrochez les passants en caoutchouc de la housse au niveau du porte-gobelet **4**.
- ✎ Faites passer la housse avec l'évidement par-dessus l'appui-tête **3**.



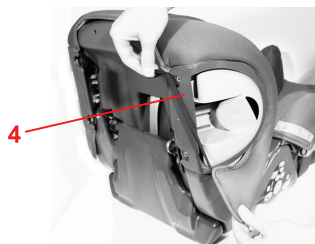
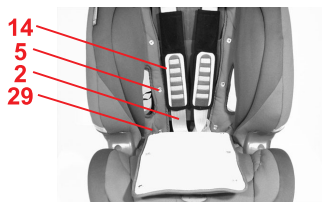

8.4 EVOLVA 1-2-3 plus: Abziehen des Bezuges

- ✎ Lockern Sie die Schultergurte (siehe 4.5).
- ✎ Öffnen Sie den Klettverschluss am Schrittpolster **23** und nehmen Sie es ab.
- ✎ Öffnen Sie die Druckknöpfe **5** links und rechts am Bezug der Rückenlehne **29** und der Kopfstütze **3**.
- ✎ Hängen Sie die Bezugskante und die Gummischlaufen unter dem Rand des Kindersitzes aus.
- ✎ Nehmen Sie den Bezug der Kopfstütze **3** ab.
- ✎ Fädeln Sie das Gurtschloss **15** und den Verstellgurt **17** aus dem Bezug aus.
- ✎ Hängen Sie auf der Sitzunterseite die Gummischlaufen des Bezuges am Becherhalter **4** aus.
- ✎ Stülpen Sie den Bezug mit der Aussparung über die Kopfstütze **3**.

GB

User instructions

8.4 EVOLVA 1-2-3 plus: Removing the cover

- ✎ Loosen the shoulder straps (see 4.5).
- ✎ Undo the Velcro fastener on the crotch cushion **23** and remove it.
- ✎ Open the poppers **5** at the left and right on the cover of the backrest **29** and the headrest **3**.
- ✎ Take the seam of the cover and the elastic loops off the hooks under the edge of the child seat.
- ✎ Remove the cover of the headrest **3**.
- ✎ Unthread the harness buckle **15** and the adjustment strap **17** from the cover.
- ✎ On the underside of the seat, unhook the elastic loops of the cover at the drink holder **4**.
- ✎ Put the cover with the recess over the headrest **3**.

F

Mode d'emploi

8.4 EVOLVA 1-2-3 plus : retrait de la housse

- ✎ Desserrez les bretelles (voir le point 4.5).
- ✎ Ouvrez la fermeture velcro du rembourrage de l'entre-jambes **23** et retirez-le.
- ✎ Ouvrez les boutons-pressions **5** à gauche et à droite de la housse du dossier **29** et de l'appui-tête **3**.
- ✎ Décrochez les élastiques de la housse et les passants en caoutchouc situés sous le bord de la coque.
- ✎ Retirez la housse de l'appui-tête **3**.
- ✎ Sortez le fermoir de la ceinture **15** et la sangle de réglage **17** de la housse.
- ✎ Sur la partie inférieure du siège, décrochez les passants en caoutchouc de la housse au niveau du porte-gobelet **4**.
- ✎ Faites passer la housse avec l'évidement par-dessus l'appui-tête **3**.



8.5 Aufziehen des Bezuges

- ☞ Gehen Sie einfach in umgekehrter Reihenfolge wie in 8.3/8.4 beschrieben vor.
- ☞ **Vorsicht!** Vergewissern Sie sich, dass die Gurte nicht verdreht sind und richtig in die Gurtschlitz des Bezuges eingelegt sind.

8.6 Einbau der Gurte

- ☞ Schieben Sie die Metallplatte **19** hochkant von oben nach unten durch den Gurtschlitz **20**.
Vorsicht! Ziehen Sie kräftig am Gurtschloss **15**, um die Befestigung zu überprüfen.
- ☞ Fädeln Sie die Schultergurte **2** mit den Schlossezungen **16** in den Bezug ein.
- ☞ Befestigen Sie das Schrittpolster **23**.
- ☞ Rasten Sie die Schlossezungen **16** im Gurtschloss ein (siehe 5.4).
Vorsicht! Gurte nicht verdrehen oder vertauschen.

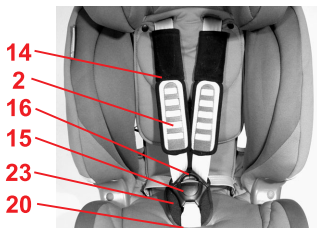
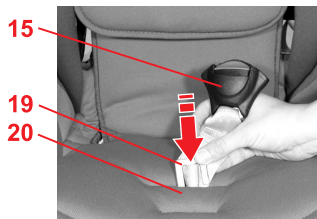

GB

User instructions

8.5 Re-fitting the cover

- ✎ Reverse the previous instructions of how to remove the cover.
- ✎ **Caution!** Ensure that the straps are not twisted and that they were correctly inserted in the belt slots of the cover.

8.6 Installing the harness

- ✎ Push the metal plate **19** on its side downwards through the belt slot **20**.
Caution! Check for correct fitting by pulling firmly on the harness buckle **15**.

- ✎ Thread the shoulder straps **2** and the buckle tongues **16** through the cover.
- ✎ Attach the crotch cushion **23**.
- ✎ Engage the buckle tongues **16** in the harness buckle (see 5.4).
Caution! Do not twist or interchange the straps.

F

Mode d'emploi

8.5 Remise en place de la housse

- ✎ Procédez simplement à l'inverse des points 8.3/8.4.
- ✎ **Attention !** Assurez-vous que les sangles ne sont pas torsadées et qu'elles ont bien été passées dans les fentes pour ceinture de la housse.

8.6 Montage des sangles

- ✎ Poussez la plaque métallique **19** en position verticale, du haut vers le bas, au travers de la fente pour ceinture **20**.
Attention ! Tirez fortement sur le fermoir **15** pour contrôler sa fixation.

- ✎ Enfilez les bretelles **2** avec les languettes **16** dans la housse.
- ✎ Fixez le rembourrage de l'entre-jambes **23**.
- ✎ Enclenchez les languettes **16** dans le fermoir de la ceinture (voir le point 5.4).
Attention ! Veillez à ne pas torsader ni inverser les bretelles.



Gebrauchsanleitung

- ✚ Fädeln Sie die Schulterpolster **14** auf die Schultergurte **2** auf.
- ✚ Verstellen Sie den Kopfstützen-Versteller **8** in seine unterste Position (siehe 5.2).
- ✚ Fädeln Sie die Gurtschlaufen der Schulterpolster **14** in die Gurtschlitze ein.
- ✚ Schieben Sie die Gurtschlaufen der Schulterpolster **14** auf den Steg **28** des Gurthöhen-Verstellers **1** auf.
- ✚ Fädeln Sie die Schultergurte **2** in die Gurtschlitze **5** und in den Gurthöhen-Versteller **1** ein.
Vorsicht! Gurte nicht verdrehen oder vertauschen.
- ✚ Hängen Sie die Schultergurte **2** wieder in das Verbindungsteil **22** ein.

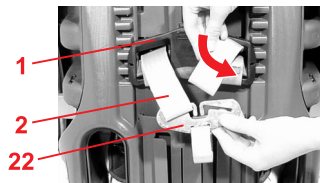
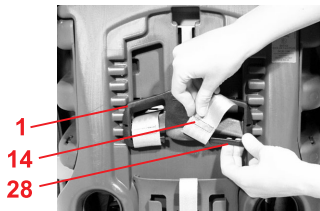

GB

User instructions

- ✎ Thread the shoulder pads **14** onto the shoulder straps **2**.
- ✎ Move the headrest adjuster **8** to its lowest position (see 5.2).
- ✎ Thread the strap loops of the shoulder pads **14** into the belt slots.
- ✎ Hook the strap loops of the shoulder pads **14** from the retainer arms **28** on the shoulder strap adjuster **1**.
- ✎ Thread the shoulder straps **2** into the belt slots **5** and into the shoulder strap adjuster **1**.
Caution! Do not twist or interchange the straps.
- ✎ Hook the shoulder straps **2** back onto the connecting piece **22**.

F

Mode d'emploi

- ✎ Placez les épaulières **14** sur les bretelles **2**.
- ✎ Placez le dispositif de réglage de l'appui-tête **8** dans sa position la plus haute (voir le point 5.2).
- ✎ Faites glisser les passants des épaulières **14** dans les fentes pour ceinture.
- ✎ Faites glisser les passants des épaulières **14** sur la boucle **28** du dispositif de réglage en hauteur des sangles **1**.
- ✎ Faites passer les bretelles **2** dans les fentes pour ceinture **5** et dans le dispositif de réglage en hauteur des sangles **1**.
Attention ! Veillez à ne pas torsader ni inverser les bretelles.
- ✎ Raccrochez les bretelles **2** à l'élément de liaison **22**.



9. Hinweise zur Entsorgung

Bitte beachten Sie die Entsorgungsbestimmungen Ihres Landes.

Entsorgung der Verpackung	
	Container für Pappe
Entsorgung der Einzelteile	
Bezug	Restmüll, thermische Verwertung
Kunststoffteile	entsprechend Kennzeichnung in die dafür vorgesehenen Container
Metallteile	Container für Metalle
Schloss und Zunge	Restmüll

10. 2 Jahre Garantie

Für diesen Auto-/Fahrradkindersitz leisten wir eine Garantie für Fabrikations- oder Materialfehler von 2 Jahren. Die Garantiezeit beginnt am Tage des Kaufes. Zum Nachweis bewahren Sie bitte die ausgefüllte Garantiekarte, den von Ihnen unterzeichneten Übergabe-Check sowie den Kaufbeleg für die Dauer der Garantiezeit auf.

GB

User instructions

9. Notes regarding disposal

Please observe the waste disposal regulations in your country.

Disposal of packaging	
	Container for paperboard
Disposal of components	
Cover	House hold rubbish, thermal utilisation
Plastic parts	Container corresponding to the label on the part
Metal parts	Container for metals
buckle and tongue	House hold rubbish

10. 2-year warranty

For this car/bicycle child seat / pushchair we provide a 2-year warranty against manufacturing or material defects. The warranty period is effective from the day of purchase. As proof we ask that you fill out the Warranty Card and retain it for the whole term of the warranty period, together with the Transfer Check signed by you and your sales receipt.

F

Mode d'emploi

9. Remarques relatives à l'élimination

Veillez respecter les directives en vigueur dans votre pays.

Élimination de l'emballage	
	Conteneur pour le carton
Élimination des pièces détachées	
Housse	Déchets résiduels, recyclage thermique
Éléments en matière plastique	Suivant le marquage, dans le conteneur spécialement prévu à cet usage
Pièces métalliques	Conteneur pour métaux
Fermeoir et languettes	Déchets résiduels

10. 2 ans de garantie

Nous accordons une garantie de 2 ans pour ce siège auto/bicyclette en ce qui concerne les défauts de fabrication ou de matériau. La garantie débute le jour de l'achat. Pour apporter la preuve de la garantie, veuillez conserver pendant toute la durée de la garantie : la carte de garantie remplie, le procès-verbal de remise que vous avez signé ainsi





Gebrauchsanleitung



Bei Reklamationen ist der Garantieschein dem Kindersitz beizufügen. Die Garantieleistung beschränkt sich auf Auto-/Fahrradkindersitze, die sachgemäß behandelt wurden und die in sauberem und ordentlichem Zustand zurückgesandt werden.

Die Garantie erstreckt sich nicht auf:

- Natürliche Abnutzungserscheinungen und Schäden durch übermäßige Beanspruchung
- Schäden durch ungeeignete oder unsachgemäße Verwendung

Garantiefall oder nicht?

Stoffe: Alle unsere Stoffe erfüllen hohe Anforderungen in Bezug auf Farbbeständigkeit gegen UV-Strahlung. Dennoch bleichen alle Stoffe aus, wenn sie der UV-Strahlung ausgesetzt sind. Hierbei handelt es sich um keinen Materialfehler, sondern um normale Verschleißerscheinungen, für die keine Garantie übernommen wird.

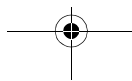
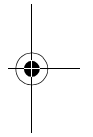
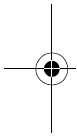

GB

User instructions

In the case of a warranty claim, the Warranty Card must be returned together with the product. The warranty covers only car/bicycle child seats / pushchairs which have been handled properly and which have been sent to us in a clean condition.

The Warranty does not cover:

- natural signs of wear and damage resulting from excessive stress.
- damage resulting from inappropriate or improper use.

What is covered by the warranty?

Fabrics: All our materials meet very high requirements with regard to colour fastness when exposed to UV radiation. Nevertheless, all fabrics fade when exposed to UV radiation. This is not a material defect, but rather a normal sign of wear which is not covered by the warranty.

F

Mode d'emploi

que la facture d'achat.

Pour toute réclamation, le bon de garantie doit être joint au siège enfant. La prestation de garantie est limitée aux sièges auto/ bicyclette qui ont été utilisés conformément à l'usage prévu et qui sont renvoyés propres et complets.

La garantie ne couvre pas les défauts suivants :

- usure naturelle et dommages dus à une sollicitation excessive
- dommages dus à une utilisation inappropriée ou non conforme

Cas de garantie ou non ?

Tissus : tous nos tissus répondent à des exigences élevées quant à la résistance des couleurs aux rayons UV. Malgré tout, les tissus se décolorent lorsqu'ils sont soumis aux rayons UV. Dans ce cas, il ne s'agit pas d'un défaut de matériel, mais d'une usure normale qui n'est pas couverte par la garantie.





Gebrauchsanleitung



Schloss: Sollten Funktionsstörungen am Gurtschloss auftreten, so sind diese meist auf Verunreinigungen zurückzuführen, welche ausgewaschen werden können. Bitte halten Sie sich in der Vorgehensweise an Ihre Gebrauchsanleitung.

Im Garantiefall wenden Sie sich bitte unverzüglich an Ihren Fachhändler. Er wird Ihnen mit Rat und Tat zur Seite stehen. Bei der Bearbeitung von Reklamationsansprüchen kommen produktspezifische Abschreibungssätze zur Anwendung. Hier verweisen wir auf die beim Händler ausliegenden Allgemeinen Geschäftsbedingungen.

Verwendung, Pflege und Wartung

Der Auto-/Fahrradkindersitz muss entsprechend der Gebrauchsanleitung behandelt werden. Wir weisen ausdrücklich darauf hin, dass nur Original-Zubehör bzw. Ersatzteile verwendet werden dürfen.

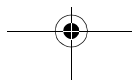
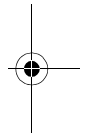
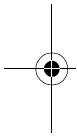

GB

User instructions

Buckle: Buckle malfunction is often due to accumulations of dirt and dust which may stop it from working properly. If this happens, the buckle can be washed out. Please refer to your user instructions.

Please contact your retailer directly in the event of a warranty claim. He or she will give you the advice and support you need. When processing claims, product-specific depreciation rates will be applied. Please refer to our General Terms and Conditions which are available from your retailer.

Use, care and maintenance

The car/bicycle child seat / pushchair must be used in accordance with the user instructions. We would like to point out that it is extremely important that only Britax/RÖMER accessories and replacement parts are used.

F

Mode d'emploi

Fermeture : au cas où le fermoir présenterait des dysfonctionnements, ceux-ci sont souvent dus aux encrassements qui peuvent être enlevés par lavage. Veuillez vous conformer aux instructions de votre mode d'emploi.

En cas de recours en garantie, veuillez vous adresser immédiatement à votre revendeur spécialisé. Il vous assistera volontiers. Lors du traitement des réclamations, les taux d'amortissement spécifiques au produit sont appliqués. Pour cela, veuillez consulter nos conditions générales de vente disponibles auprès de votre revendeur.

Utilisation, entretien et maintenance

Le siège auto/bicyclette doit être traité conformément au mode d'emploi. Nous signalons expressément que seuls les accessoires et les pièces de rechange d'origine doivent être utilisés.



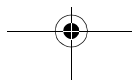
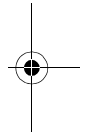
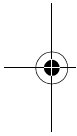



11. Garantiekarte / Übergabe-Check

Name:

Adresse:

Postleitzahl:

Ort:

Telefon (mit Vorwahl):

E-Mail:

Auto-/Fahrradkindersitz:

Artikel-Nummer:

Stoff-Farbe (Dessin):

Zubehör:

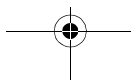
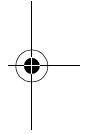
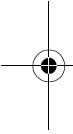

Übergabe-Check:

- 1. Vollständigkeit** geprüft / in Ordnung Ich habe den Auto-/Fahrradkindersitz / Kinderwagen geprüft und mich vergewissert, dass der Sitz komplett übergeben wurde und dass alle Funktionen vollständig funktionieren.
- 2. Funktionsprüfung**
- Verstellmechanismus Sitz geprüft / in Ordnung
- Gurtzeug-Verstellung geprüft / in Ordnung
- 3. Unversehrtheit**
- Sitz überprüfen geprüft / in Ordnung
- Stoffteile überprüfen geprüft / in Ordnung
- Kunststoffteile überprüfen geprüft / in Ordnung
- Ich habe ausreichend Informationen über das Produkt und seine Funktionen vor dem Kauf erhalten und die Pflege- und Wartungsanweisungen zur Kenntnis genommen.



Kaufdatum: _____

Käufer (Unterschrift): _____

Händler: _____

Händler Stempel

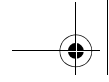

GB

11. Warranty Card / Transfer Check

Name:

Address:

Post Code:

City/Town:

Telephone No.
(including area code):

e-mail address:

The child seat:

Article No.:

Fabric colour
(design):

Accessories:

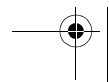
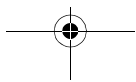
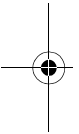
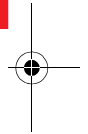

GB

Transfer Check:

1. Completeness

examined / OK

I have checked the child car/bicycle seat and am sure that the seat was complete on delivery and that all functions are sound.

2. Function test

- Seat adjustment mechanism

examined / OK

I received adequate information on the product and its functions prior to purchase and have noted the care and maintenance instructions.

- Harness adjustment

examined / OK

3. Intactness

- Seat

examined / OK

- Fabrics

examined / OK

- Plastic parts

examined / OK

Date of purchase:

Buyer (signature):

Retailer:

Retailer's stamp

GB

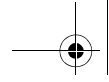

F

11. Carte de garantie/procès-verbal de remise

Nom :

Adresse :

Code postal :

Ville :

Téléphone (avec indicatif) :

E-mail :

Siège auto/bicyclette :

Référence :

Couleur du tissu (dessin) :

Accessoires :

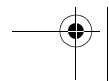
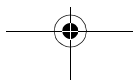
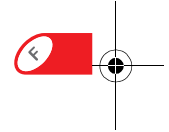
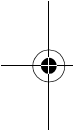

F

Procès-verbal de remise :

1. Intégralité

contrôlé/en ordre

J'ai contrôlé le siège auto/bicyclette et vérifié qu'il m'a été remis en bon état et complet, et que toutes les fonctions sont parfaitement opérationnelles.

2. Contrôle fonctionnel

- Mécanisme de réglage siège

contrôlé/en ordre

- Réglage des sangles

contrôlé/en ordre

J'ai reçu des informations suffisantes concernant le produit et ses fonctions avant l'achat, et j'ai pris connaissance des instructions d'entretien et de maintenance.

3. Absence de dommages

- Contrôle du siège

contrôlé/en ordre

- Contrôle des éléments textiles

contrôlé/en ordre

- Contrôle des éléments en matière plastique

contrôlé/en ordre

Date d'achat :

Acheteur (signature) :

Revendeur :

Cachet du revendeur

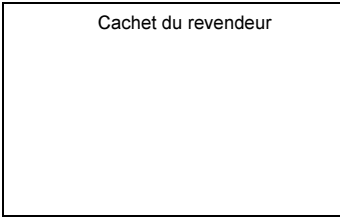



EVOLVA 1-2-3 EVOLVA 1-2-3 plus

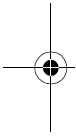

1

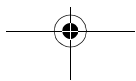

Instrucciones de uso

Instrucciones de uso

Nos alegramos de que nuestro EVOLVA 1-2-3 pueda acompañar a su hijo a través de una nueva etapa de su vida.

Para poder proteger bien a su bebé, es imprescindible instalar y utilizar el EVOLVA 1-2-3 tal y como se indica en estas instrucciones.

Para más información, póngase en contacto con nosotros.

Britax Excelsior Ltd.

Contenido

1. **Idoneidad** 5
2. **Utilización en el vehículo** 9
3. **Indicaciones importantes** 13
4. **Utilización del asiento infantil para vehículos para niños con un peso corporal de 9 a 18 kg** 17
 - 4.1 Ajuste de los cinturones de los hombros 17
 - 4.2 Ajuste de la inclinación del asiento infantil para vehículos 19
 - 4.3 Instalación en el vehículo 19
 - 4.4 Montaje correcto del asiento infantil 27
 - 4.5 Distensión de los cinturones 29

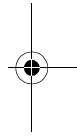



Manual de instruções

Temos todo o prazer pelo nosso **EVOLVA 1-2-3** poder acompanhar o seu filho numa nova fase da vida.

Para assegurar a protecção correcta do seu filho, o EVOLVA 1-2-3 deverá ser utilizado e montado conforme descrito neste manual.

Caso tenha dúvidas relativamente à utilização, consulte-nos.

Britax Excelsior Ltd.

Índice

1. Aptidão	6
2. Utilização no veículo	10
3. Indicações importantes	14
4. Utilização da cadeira de criança para automóvel para crianças com um peso de 9 - 18 kg	18
4.1 Ajuste dos cintos para os ombros	18
4.2 Ajuste da inclinação da cadeira de criança para automóvel	20
4.3 Montagem no veículo	20
4.4 A sua cadeira de criança para automóvel está correctamente montada	28
4.5 Desapertar os cintos	30



Istruzioni per l'uso

Siamo lieti che il nostro **EVOLVA 1-2-3** possa accompagnare in modo sicuro il vostro bambino durante un nuovo periodo della sua vita.

Per garantire una corretta protezione del vostro bambino, EVOLVA 1-2-3 deve necessariamente essere utilizzato e montato come descritto nelle presenti istruzioni.

In caso di ulteriori domande in merito all'utilizzo, non esitate a contattarci.

Britax Excelsior Ltd.

Indice

1. Idoneità	6
2. Utilizzo in auto	10
3. Avvertenze importanti	14
4. Utilizzo del seggiolino da auto per bambini con peso corporeo di 9 - 18 kg	18
4.1 Adattamento delle cinture spalle	18
4.2 Regolazione dell'inclinazione del seggiolino da auto	20
4.3 Montaggio in auto	20
4.4 Corretta installazione del seggiolino da auto	28
4.5 Allentamento delle cinture	30



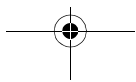
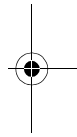
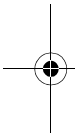

E

Instrucciones de uso

- 4.6 Abrochar el cinturón al niño 31
- 4.7 Tensión de los cinturones 33
- 4.8 Protección perfecta del niño 37
- 5. Utilización del asiento infantil para vehículos para niños con un peso corporal de 15 a 36 kg 39**
 - 5.1 Desinstalación del cinturón de 5 puntos 39
 - 5.2 Regulación de la altura del reposacabezas 43
 - 5.3 Ajuste de la inclinación del asiento infantil para vehículos 45
 - 5.4 Abrochar el cinturón al niño 45
 - 5.5 Protección perfecta del niño 51
- 6. EVOLVA 1-2-3 plus : Regulación de la anchura del respaldo 53**
- 7. Empleo de los portabebidas desplegables 53**
- 8. Instrucciones de mantenimiento 55**
 - 8.1 Mantenimiento del broche del cinturón 57
 - 8.2 Limpieza 61
 - 8.3 Extracción de la funda 63
 - 8.4 EVOLVA 1-2-3 plus: Extracción de la funda 65
 - 8.5 Colocación de la funda 67
 - 8.6 Instalación de los cinturones 67
- 9. Instrucciones sobre la eliminación de los componentes 71**
- 10. 2 años de garantía 71**
- 11. Tarjeta de garantía / Control de entrega 78**

Manual de instruções

4.6	Aperte o cinto de segurança da sua criança	32
4.7	Apertar os cintos	34
4.8	Assim a criança está correctamente protegida	38
5.	Utilização da cadeira de criança para automóvel para crianças com um peso de 15 - 36 kg	40
5.1	Desmontagem do conjunto de cintos de 5 pontos de fixação	40
5.2	Ajuste em altura do apoio para a cabeça	44
5.3	Ajuste da inclinação da cadeira de criança para automóvel	46
5.4	Aperte o cinto de segurança do seu filho	46
5.5	Assim a criança está correctamente protegida	52
6.	EVOLVA 1-2-3 plus : Ajuste da largura do encosto	54
7.	Utilização do suporte para bebidas giratório	54
8.	Instruções de conservação	56
8.1	Conservação do fecho do cinto	58
8.2	Limpeza	62
8.3	Remoção do revestimento	64
8.4	EVOLVA 1-2-3 plus: Remoção do revestimento	66
8.5	Colocação do revestimento	68
8.6	Montagem dos cintos	68
9.	Indicações sobre a eliminação	72
10.	Garantia de 2 anos	72
11.	Certificado de garantia / verificação de transferência	80

Istruzioni per l'uso

4.6	Allacciamento del vostro bambino	32
4.7	Tensionamento delle cinture	34
4.8	Corretto posizionamento del vostro bambino ..	38
5.	Utilizzo del seggiolino da auto per bambini con peso corporeo di 15 - 36 kg	40
5.1	Smontaggio della cintura a 5 punti	40
5.2	Regolazione in altezza del poggiatesta	44
5.3	Regolazione dell'inclinazione del seggiolino da auto	46
5.4	Allacciamento del vostro bambino	46
5.5	Corretto posizionamento del vostro bambino	52
6.	EVOLVA 1-2-3 plus : Regolazione della larghezza dello schienale	54
7.	Uso del portabevande girevole	54
8.	Istruzioni di manipolazione	56
8.1	Manipolazione della chiusura della cintura	58
8.2	Pulizia	62
8.3	Rimozione del rivestimento	64
8.4	EVOLVA 1-2-3 plus: Rimozione del rivestimento	66
8.5	Applicazione del rivestimento	68
8.6	Montaggio delle cinture	68
9.	Avvertenze per lo smaltimento	72
10.	Garanzia di 2 anni	72
11.	Cartolina di garanzia/ricevuta del controllo alla consegna	82



E

Instrucciones de uso

1. Idoneidad

El EVOLVA 1-2-3 está homologado como asiento infantil para vehículos para los grupos de edades I y II+III conforme a la norma europea ECE R 44/04.

Para proteger de forma óptima al niño de cualquier edad, el EVOLVA 1-2-3 dispone de dos sistemas de cinturones:



Asiento infantil para vehículos Britax	Control y autorización conforme a ECE* R 44/04	
	Grupo	Peso corporal
EVOLVA 1-2-3	I	de 9 a 18 kg

*ECE = Norma europea para equipos de seguridad



Los niños con un peso corporal inferior a 15 kg deben ser asegurados en el EVOLVA 1-2-3 con el **cinturón integrado de 5 puntos del asiento infantil**. Recomendamos utilizar el cinturón de 5 puntos hasta que el niño tenga un peso corporal de 18 kg.



El EVOLVA 1-2-3 se instala de forma fija en el automóvil con el cinturón de 3 puntos del vehículo.



Manual de instruções

1. Aptidão

O EVOLVA 1-2-3 está homologado de acordo com o ECE R44/04 enquanto cadeira de criança para automóvel para as faixas etárias I e II+III.

Para poder proteger a sua criança na perfeição em qualquer idade, o EVOLVA 1-2-3 dispõe de dois sistemas de cintos:



9 - 18 kg

Cadeira de criança para automóvel Britax	Verificação e autorização de acordo com a norma ECE* R 44/04	
	Grupo	Peso
EVOLVA 1-2-3	I	9 a 18 kg

*ECE = Norma europeia sobre equipamento de segurança



Crianças com um peso inferior a 15 kg têm de ser seguras no EVOLVA 1-2-3 com o **conjunto integrado de cintos de 5 pontos de fixação do assento para criança**. Nós recomendamos a utilização do conjunto de cintos de 5 pontos de fixação, até a sua criança atingir um peso de 18 kg.



O EVOLVA 1-2-3 é montado fixamente no automóvel com cinto de 3 pontos de fixação do veículo.



Istruzioni per l'uso

1. Idoneità

L'EVOLVA 1-2-3 è omologato come seggiolino da auto per le fasce di età I e II+III a norma ECE R44/04.

L'EVOLVA 1-2-3 dispone di due sistemi di cinture in modo da garantire la protezione dei bambini di ogni età:



9 - 18 kg

Seggiolino da auto Britax	Collaudo e omologazione a norma ECE* R 44/04	
	Gruppo	Peso corporeo
EVOLVA 1-2-3	I	da 9 a 18 kg

*ECE = Normativa europea per dotazioni di sicurezza



Nell' EVOLVA 1-2-3 i bambini con un peso corporeo inferiore a 15 kg devono essere assicurati con la cintura a **5 punti incorporata**. Si consiglia di utilizzare la cintura a 5 punti finché il bambino non ha raggiunto un peso di 18 kg.



L'EVOLVA 1-2-3 viene montato in modo fisso nel veicolo con la cintura a 3 punti.



9 - 18 kg





E

Instrucciones de uso

15 - 36 kg

Asiento infantil
para vehículos
Britax

Control y autorización
conforme
a ECE* R 44/04

EVOLVA 1-2-3

Grupo	Peso corporal
-------	---------------

II+III	de 15 a 36 kg
--------	---------------

*ECE = Norma europea para equipos de seguridad



Los niños con un peso corporal de más de 18 kg deben ser asegurados en el EVOLVA 1-2-3 con el **cinturón de 3 puntos del vehículo**.



El EVOLVA 1-2-3 no se instala de forma fija en el automóvil. Se asegura junto con el niño mediante el cinturón de 3 puntos del vehículo.

Manual de instruções



Cadeira de criança para automóvel Britax	Verificação e autorização de acordo com a norma ECE* R 44/04	
	Grupo	Peso
EVOLVA 1-2-3	II+III	15 a 36 kg

*ECE = Norma europeia sobre equipamento de segurança



Crianças com um peso superior a 18 kg têm de ser seguras no EVOLVA 1-2-3 com o **cinto de 3 pontos de fixação do veículo**.



O EVOLVA 1-2-3 não é montado fixamente no automóvel. Ele simplesmente é seguro juntamente com a criança pelo cinto de 3 pontos de fixação do veículo.

Istruzioni per l'uso



Seggiolino da auto Britax	Collaudo e omologazione a norma ECE* R 44/04	
	Gruppo	Peso corporeo
EVOLVA 1-2-3	II+III	da 15 a 36 kg

*ECE = Normativa europea per dotazioni di sicurezza



Nell' EVOLVA 1-2-3 i bambini con un peso corporeo superiore a 18 kg devono essere assicurati con la cintura a **3 punti**.



L'EVOLVA 1-2-3 non viene montato in modo fisso nell'auto. Viene semplicemente assicurato insieme al vostro bambino mediante la cintura a 3 punti del veicolo.



Homologación

- El asiento infantil para vehículos ha sido diseñado, probado y homologado conforme a las exigencias de la norma europea para dispositivos de seguridad para niños (ECE R 44/04). El distintivo de control E (en un círculo) y el número de autorización se encuentran en la etiqueta de homologación (pegatina sobre el asiento infantil).
- La homologación deja de ser válida en el momento en que se realice alguna modificación en el asiento infantil. Las modificaciones debe efectuarlas exclusivamente el fabricante.
- El EVOLVA 1-2-3 sólo debe utilizarse para la seguridad del niño en el vehículo. En ningún caso es adecuado como asiento o juguete en casa.



2. Utilización en el vehículo



¡Peligro! Si el niño se sujeta al asiento infantil con un cinturón de sólo 2 puntos, un accidente puede causarle lesiones graves o incluso la muerte.





Autorização

- A cadeira de criança para automóvel está equipada, verificada e homologada de acordo com os requisitos da norma europeia sobre dispositivos de segurança para crianças (ECE R 44/04). O certificado de verificação E (num círculo) e o número de homologação encontram-se na etiqueta de homologação (autocolante na cadeira de criança para automóvel).
- A autorização extingue-se logo que a cadeira de criança para automóvel sofra alterações. As alterações devem ser efectuadas exclusivamente pelo fabricante.
- O EVOLVA 1-2-3 deve ser utilizado exclusivamente para a segurança da criança dentro do veículo. Não é, em circunstância alguma, apropriado como assento ou como brinquedo dentro de casa.

2. Utilização no veículo



Perigo! Se a criança estiver segura no assento para criança apenas com um cinto de 2 pontos de fixação, em caso de acidente, ela pode ficar gravemente ferida e até mesmo morrer.



Omologazione

- Il seggiolino da auto è progettato, collaudato e omologato conformemente ai requisiti della normativa europea per i dispositivi di sicurezza per bambini (ECE R 44/04). Il marchio di collaudo E (all'interno di un cerchio) e il numero di omologazione sono indicati sull'etichetta di omologazione (adesivo presente sul seggiolino da auto).
- L'omologazione decade non appena vengono apportate modifiche al seggiolino. Le modifiche possono essere apportate esclusivamente dal produttore.
- L'EVOLVA 1-2-3 deve essere utilizzato esclusivamente per la sicurezza del bambino in auto. Non è adatto in alcun caso come seggiolino da casa o giocattolo.

2. Utilizzo in auto



Pericolo! Se il vostro bambino viene assicurato nel seggiolino solamente mediante una cintura a 2 punti, in caso di incidente potrebbe riportare lesioni gravi o potrebbe rischiare la vita.





Instrucciones de uso



No lo utilice nunca en combinación con un cinturón de 2 puntos.

Usos permitidos del asiento infantil:

en el sentido de la marcha	sí
en sentido contrario a la marcha	no 1)
con cinturón de 2 puntos	no
con cinturón de 3 puntos 2)	sí
en el asiento del copiloto	sí 3)
en asientos posteriores laterales	sí
en el asiento posterior central (con cinturón de 3 puntos)	sí 4)

(Consulte las regulaciones vigentes en su país)

1) Su utilización está permitida en un asiento del vehículo orientado en sentido contrario a la marcha (p. ej. vehículo comercial tipo Van, minibus), que también está homologado para el transporte de adultos. El asiento no puede tener airbag.

2) El cinturón debe estar homologado conforme a la norma ECE R 16 (u otra similar), que se indica, por ejemplo, mediante el símbolo "E", "e" rodeado por un círculo en la etiqueta de homologación del cinturón.

3) Con airbag frontal: retirar el asiento del copiloto hacia atrás a la mayor distancia posible y observar las indicaciones del manual del vehículo.

4) El uso no es posible si se dispone únicamente de un cinturón de 2 puntos.

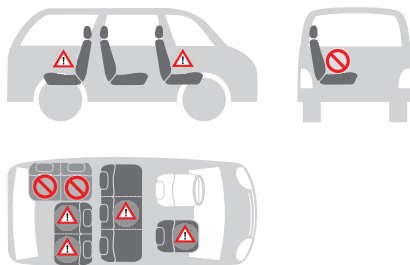



Manual de instruções



Nunca utilizar em conjunto com um cinto de 2 pontos de fixação!

Pode utilizar a sua cadeira de criança para automóvel do seguinte modo:

no sentido da marcha do veículo	sim
no sentido contrário ao da marcha	não 1)
com cinto de 2 pontos de fixação	não
com cinto de 3 pontos de fixação 2)	sim
no banco do passageiro	sim 3)
nos bancos traseiros laterais	sim
no assento traseiro do meio (com cinto de 3 pontos de fixação)	sim 4)

(Preste atenção às prescrições do seu país)

- 1) A utilização só é permitida num assento do veículo virado para trás (p. ex. van, minibus) que também esteja autorizado para o transporte de adultos. Nesse lugar não deve estar activo qualquer airbag.
- 2) O cinto tem de estar homologado conforme a norma ECE R 16 (ou norma semelhante) p. ex. reconhecido no "E" em redor, "e" na etiqueta de verificação no cinto.
- 3) no caso de airbag frontal: deslocar o banco do passageiro o mais para trás possível, se necessário, seguir indicações no manual de instruções do veículo.
- 4) A utilização não é possível quando existir apenas um cinto de 2 pontos de fixação.



Istruzioni per l'uso



Non utilizzate mai in combinazione con una cintura a 2 punti!

Potete utilizzare il vostro seggiolino da auto come indicato di seguito:

in direzione di marcia	sì
in senso opposto alla direzione di marcia	no 1)
con cintura a 2 punti	no
con cintura a 3 punti 2)	sì
sul sedile del passeggero	sì 3)
su sedili posteriori esterni	sì
sul sedile posteriore centrale (con cintura a 3 punti)	sì 4)

(Osservare le disposizioni del vostro paese)

- 1) L'utilizzo è consentito solamente su un sedile dell'auto rivolto all'indietro (ad es. van, minibus), che è omologato anche per il trasporto di adulti. Nessun airbag deve essere attivo sul sedile.
- 2) La cintura deve essere omologata a norma ECE R 16 (o norma comparabile), riconoscibile ad es. dalla "E", "e" contornata sull'etichetta di collaudo presente sulla cintura.
- 3) In caso di airbag frontale: spingere ampiamente all'indietro il sedile del passeggero, eventualmente attenersi alle indicazioni riportate nel manuale dell'automobile.
- 4) L'utilizzo non è possibile se è presente solamente una cintura a 2 punti.





3. Indicaciones importantes



Para la protección del niño

- Principalmente es válido: cuanto más ajuste el cinturón al cuerpo del niño, mayor será la seguridad.
- Nunca deje al bebé en el asiento infantil sin vigilancia.
- Uso en el asiento posterior: coloque el asiento delantero tan adelantado que el niño no pueda tocar con los pies el respaldo del asiento delantero (peligro de lesiones).
- Las piezas de metal y de plástico del asiento infantil se calientan cuando se exponen al sol. **¡Cuidado!** El niño podría quemarse si las toca. Por ello es recomendable proteger el asiento infantil de una irradiación solar intensa cuando no se está utilizando.
- Permita que el niño suba y baje únicamente por el lado de la acera.
- Haga más cómodos los viajes largos mediante pausas en las que su niño disfrute de libertad de movimientos.

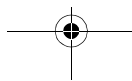
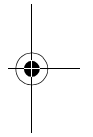
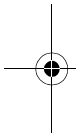



3. Indicações importantes



Para protecção do seu filho

- É válido fundamentalmente: Quanto mais justo ao corpo da criança estiver o cinto, tanto maior será a segurança.
- Nunca deixe a criança sem vigilância na cadeira de criança para automóvel.
- Utilização no banco traseiro: Coloque o assento dianteiro o mais para a frente possível de forma que a criança não bata com os pés no encosto do assento dianteiro (perigo de ferimentos).
- As peças em metal e material sintético do assento para criança aquecem quando expostas ao sol.
Cuidado! A criança pode, por isso, queimar-se. Quando não estiver a ser utilizado, proteja o assento para criança contra uma exposição solar intensa.
- Deixe a criança entrar e sair apenas pelo lado do passeio.
- Faça pausas em grandes viagens, para que a criança possa exercitar os seus movimentos.



3. Avvertenze importanti



Per la protezione del vostro bambino

- In linea di massima vale quanto indicato di seguito: quanto più la cintura aderisce al corpo del bambino, tanto maggiore è la sicurezza.
- Non lasciate mai incustodito il vostro bambino dopo averlo sistemato nel seggiolino in auto.
- Utilizzo sul sedile posteriore: posizionate il sedile anteriore il più possibile in avanti fino a quando il vostro bambino con i piedi non tocca lo schienale del sedile anteriore (pericolo di lesione).
- Le parti in metallo e plastica del seggiolino si surriscaldano se esposte al sole.
Attenzione! In caso di contatto, il bambino può scottarsi. Proteggete il seggiolino, se non viene utilizzato al momento, da radiazioni solari intense.
- Fate salire e scendere il bambino solamente dal lato di accesso.
- Alleggerite i viaggi lunghi con pause, durante le quali il vostro bambino può assecondare lo stimolo di muoversi.





Instrucciones de uso



Para mayor protección de todos los ocupantes del vehículo

En caso de frenada de emergencia o accidente, los objetos y las personas que no estén asegurados pueden lesionar a otros ocupantes. Por ello, es recomendable que se asegure de que:

- los respaldos de los asientos del vehículo estén fijados (p. ej.: bloquee el asiento trasero abatible).
- todos los objetos pesados o de bordes afilados que vayan en el vehículo estén bien sujetos (p. ej. en la percha).
- todos los ocupantes lleven abrochado el cinturón de seguridad.
- el asiento infantil esté siempre bien fijado, aunque no esté ocupado.

Para mayor protección de su vehículo

- En las tapicerías de los vehículos hechas con materiales delicados (p. ej. terciopelo, piel, etc.), el uso de asientos infantiles puede dejar marcas.

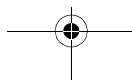
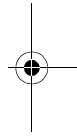
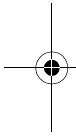



Manual de instruções



Para a protecção de todos os ocupantes do veículo

Em caso de uma travagem de emergência ou em caso de acidente, objectos e pessoas não seguros podem ferir outros ocupantes. Por isso, preste sempre atenção para que

- os encostos do assento do condutor estejam fixos (p.ex. encaixar encosto do banco rebatível).
- no veículo (p.ex. na chapeleira) todos os objectos pesados ou de arestas afiadas estejam seguros.
- todas as pessoas tenham o cinto de segurança colocado.
- a cadeira de criança para automóvel esteja sempre fixa, mesmo quando não transportar nenhuma criança.

Para protecção do seu automóvel

- Em alguns revestimentos dos assentos do automóvel em material delicado (p.ex. veludo, pele, etc.) podem aparecer vestígios de desgaste devido às cadeiras para crianças.



Istruzioni per l'uso



Per la protezione di tutti i passeggeri

In caso di frenata brusca o di incidente, gli oggetti non fissati o le persone non allacciate possono ferire gli altri passeggeri. Pertanto, assicuratevi sempre che...

- gli schienali dei sedili dell'auto siano bloccati (ad es. fate scattare in posizione i sedili posteriori ribaltabili);
- tutti gli oggetti pesanti o con spigoli vivi presenti in auto (ad es. sul ripiano posteriore) siano fissati;
- tutte le persone presenti all'interno dell'auto siano allacciate;
- il seggiolino da auto sia sempre fissato all'interno dell'auto, anche se non viene trasportato alcun bambino.

Per la protezione della vostra automobile

- A causa dell'uso di seggiolini da auto, alcuni rivestimenti in materiale delicato dei sedili (ad es. velluto, pelle, ecc.) possono presentare tracce di usura.



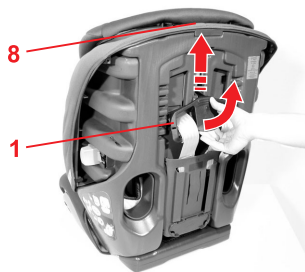
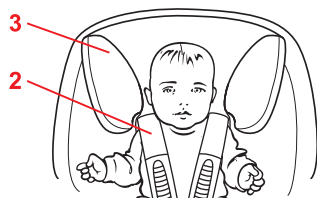

E

Instrucciones de uso

4. Utilización del asiento infantil para vehículos para niños con un peso corporal de 9 a 18 kg



4.1 Ajuste de los cinturones de los hombros



Un ajuste correcto de los cinturones de los hombros proporcionará al niño una sujeción óptima en el asiento.

Los cinturones de los hombros **2** deben colocarse a la altura de los hombros del niño o ligeramente por encima.

La altura de los cinturones puede ajustarse a la estatura del niño de la siguiente manera:

- ✎ Afloje los cinturones al máximo (véase 4.5).
- ✎ Incline el regulador de altura del cinturón **1** para desengancharlo.
- ✎ Desplace el regulador de altura del cinturón **1** hasta la altura correcta del cinturón de los hombros y encájelo.
¡Cuidado! Asegúrese de que el regulador del reposacabezas **8** se encuentra en la posición más baja.

Manual de instruções

4. Utilização da cadeira de criança para automóvel para crianças com um peso de 9 - 18 kg



4.1 Ajuste dos cintos para os ombros



Os cintos para os ombros correctamente ajustados proporcionam à sua criança uma óptima postura na cadeira para automóvel.

O cintos para os ombros **2** têm de passar pela altura dos ombros da sua criança ou um pouco acima.

Pode ajustar a altura dos cintos para os ombros à altura da sua criança da seguinte forma:

- ✂ Solte os cintos o máximo possível (ver 4.5).
- ✂ Incline o dispositivo de ajuste da altura do cinto **1** para fora do engate.
- ✂ Desloque o dispositivo de ajuste da altura do cinto **1** para a altura correcta dos ombros e encaixe-o. **Cuidado!** Preste atenção para que o regulador dos apoios para a cabeça **8** se encontre na sua posição mais baixa.

Istruzioni per l'uso

4. Utilizzo del seggiolino da auto per bambini con peso corporeo di 9 - 18 kg



4.1 Adattamento delle cinture spalle



Le cinture spalle correttamente adattate forniscono al vostro bambino un sostegno ottimale nel seggiolino.

Le cinture **2** devono scorrere all'altezza delle spalle del bambino o leggermente più in alto.

Potete adattare l'altezza delle cinture spalle alle dimensioni del vostro bambino come riportato di seguito:

- ✂ Allentate le cinture il più possibile (vedi 4.5).
- ✂ Sbloccate il regolatore in altezza delle cinture **1** estraendolo dall'incastro.
- ✂ Spostate il regolatore **1** nella giusta altezza della cintura spalla e fatelo scattare in posizione. **Attenzione!** Assicurarsi che il regolatore del poggiatesta **8** sia nella posizione inferiore.

9 - 18 kg



E

Instrucciones de uso

4.2 Ajuste de la inclinación del asiento infantil para vehículos



Antes de instalarlo en el vehículo, el asiento infantil se puede ajustar con dos inclinaciones distintas de la siguiente manera:

Un consejo: si el cinturón del vehículo es demasiado corto durante la instalación puede ser útil que el asiento infantil se encuentre en posición vertical.

☞ Para ello mueva la cuña distanciadora **21** hacia delante o hacia atrás hasta alcanzar la posición deseada.

- **detrás:** para estar sentado con el asiento vertical
- **delante:** para inclinarse cómodamente hacia atrás

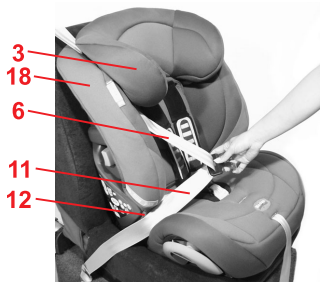
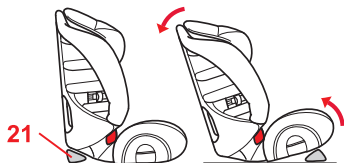

4.3 Instalación en el vehículo



Para asegurar el asiento del niño con el cinturón de 3 puntos de su vehículo, proceda del siguiente modo:

☞ Coloque el asiento infantil sobre el asiento del vehículo de forma que quede orientado en el sentido de la marcha.

☞ Pase el cinturón diagonal **6** entre el reposacabezas y la pieza lateral **18** del respaldo.
¡Cuidado! No retuerza el cinturón.

Manual de instruções

4.2 Ajuste da inclinação da cadeira de criança para automóvel



Desta forma, o assento para criança pode ser ajustado com duas inclinações antes da montagem no veículo:

Dica! Se o cinto do automóvel for demasiado curto durante a montagem, a colocação do assento para criança na posição vertical poderá ser vantajosa.

✧ Para isso, oscile a cunha espaçadora **21** para a frente ou para trás até à posição pretendida.

- **atrás:** para sentar direito
- **à frente:** para encostar confortavelmente

4.3 Montagem no veículo



Segure o seu assento para criança com o cinto de 3 pontos de fixação do seu veículo da seguinte forma:

- ✧ Coloque o assento para criança no assento do automóvel no sentido da marcha.
- ✧ Coloque o cinto diagonal **6** entre o apoio para a cabeça e a parte lateral **18** do encosto, **Cuidado!** Não torcer o cinto.

Istruzioni per l'uso

4.2 Regolazione dell'inclinazione del seggiolino da auto



Il seggiolino può essere regolato in due inclinazioni prima di essere montato nel veicolo:

Consiglio! Se la cintura è troppo corta durante il montaggio nel veicolo, allora può essere utile se il seggiolino è in posizione diritta.

✧ Perciò spostare il cuneo distanziale **21** in avanti o all'indietro nella posizione desiderata.

- **all'indietro:** per posizione diritta
- **in avanti:** per appoggiarsi comodamente allo schienale

4.3 Montaggio in auto



Fissate il seggiolino con la cintura a 3 punti della vostra auto come riportato di seguito:

- ✧ Posizionate il seggiolino in direzione di marcia sul sedile.
- ✧ Inserite la cintura diagonale **6** fra il poggiatesta e la parte laterale **18** dello schienale. **Attenzione!** Non attorcigliate la cintura.



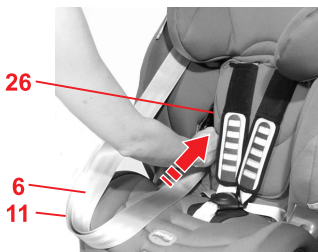



E

Instrucciones de uso

- Introduzca el cinturón de la cintura **11** en las guías de color rojo claro del cinturón **12**.
¡Cuidado! No retuerza el cinturón.
- Agarre juntos unos 80 cm del cinturón diagonal **6** y del cinturón de la cintura **11**.
¡Cuidado! No retuerza el cinturón.

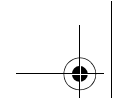
- Pase el cinturón del vehículo desde delante por la primera guía del cinturón **26** del respaldo.



 Manual de instruções

- ✘ Coloque o cinto para a cintura **11** nas guias do cinto **12** vermelhas claras.
Cuidado! Não torcer o cinto.
- ✘ Reúna aprox. 80 cm do cinto diagonal **6** e do cinto para a cintura **11**.
Cuidado! Não torcer o cinto.

 Istruzioni per l'uso

- ✘ Inserite la cintura addominale **11** nelle guide rosso chiaro **12**.
Attenzione! Non attorcigliate la cintura.
- ✘ Unire circa 80 cm della cinghia diagonale **6** e della cinghia addominale **11**.
Attenzione! Non attorcigliate la cintura.

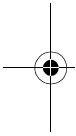

- ✘ Introduza o cinto do automóvel através da primeira passagem do cinto **26** do encosto.

- ✘ Dalla parte anteriore inserite la cinghia attraverso il primo passante **26** dello schienale.

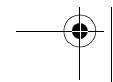
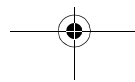
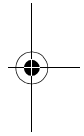

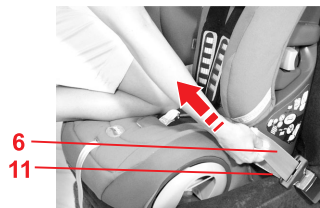
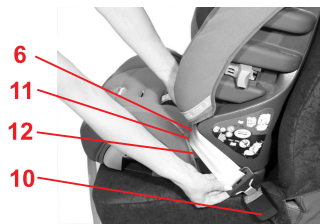
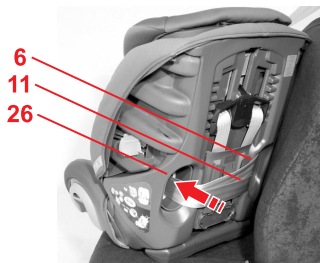

E

Instrucciones de uso

- ❖ Gire el asiento infantil apartándolo ligeramente del asiento del vehículo.
- ❖ A continuación pase el cinturón del vehículo desde detrás por la segunda guía del cinturón **26** otra vez hacia delante.
¡Cuidado! No retuerza el cinturón.
- ❖ Sitúe el cinturón diagonal **6** y el cinturón de la cintura **11** del lado del broche del cinturón del vehículo **10** en las guías del cinturón **12**.
- ❖ Introduzca la lengüeta en el broche del cinturón del vehículo **10**. CLIC

Arrodílese en el asiento infantil y tense el cinturón del automóvil de la siguiente manera:

- ❖ Tire del cinturón diagonal **6** primero por debajo en el broche del cinturón del automóvil, para tensar el cinturón de la cintura **11**.

Manual de instruções

- ✎ Afaste um pouco o assento para criança do assento do automóvel, rodando-a.
- ✎ Introduza agora o cinto do automóvel através da segunda passagem do cinto **26**, entrando na parte de trás e saindo novamente na parte da frente.
Cuidado! Não torcer o cinto.

- ✎ Passe o cinto diagonal **6** e o cinto para a cintura **11**, do lado do fecho do cinto do automóvel **10** pela guia do cinto **12**.
- ✎ Encaixe as linguetas de fecho no fecho do cinto do automóvel **10**. CLIQUE!

Ajoelhe-se no assento para criança e estique o cinto do automóvel da seguinte forma:

- ✎ Puxe o cinto diagonal **6**, comece pela parte de baixo junto ao fecho do cinto do automóvel, para esticar o cinto para a cintura **11**.

Istruzioni per l'uso

- ✎ Scostare leggermente il seggiolino dal sedile.
- ✎ Poi dalla parte posteriore riportate in avanti la cintura attraverso il secondo passante **26**.
Attenzione! Non attorcigliate la cintura.

- ✎ Inserite cintura diagonale **6** e cintura addominale **11** sul lato della chiusura **10** nelle guide **12**.
- ✎ Fate scattare la linguetta nella chiusura della cintura **10**. Dovreste udire un "clic!".

Inginocchiatevi nel seggiolino e tendete la cintura procedendo nel modo seguente:

- ✎ Tirare la cintura diagonale **6** prima in basso sulla chiusura per tendere la cinghia addominale **11**.

9 - 18 kg





6

26

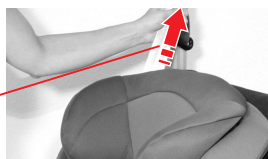

6



E

Instrucciones de uso

☞ Sujete el cinturón diagonal **6** por debajo, y después, por encima de la guía del cinturón **26** tire del cinturón diagonal **6** hacia delante para pasar el cinturón suelto.

☞ Tire con fuerza del cinturón diagonal por arriba **6**, para tensar todo el cinturón del vehículo. **¡Cuidado!** El broche del cinturón del vehículo **10** no debe quedar en ningún caso dentro de la guía del cinturón **12**. Si esto sucede, intente instalar el asiento infantil en otro asiento del vehículo o intente instalarlo en la posición reclinada hacia atrás (véase 4.2).

☞ Asegúrese de que el asiento infantil esté bien fijado al vehículo. Si no es así, vuelva a tensar el cinturón del vehículo.

Un consejo: Tire del asiento infantil hacia delante por el cinturón. No debe poder moverse en absoluto o sólo levemente.

2

Manual de instruções

- ☞ Segure bem o cinto diagonal **6** em baixo e, em seguida, agarre acima da passagem do cinto **26** e puxe o cinto diagonal **6** para a frente para puxar todo o cinto solto.

- ☞ Puxe agora a parte de cima do cinto diagonal **6** com força para esticar todo o cinto do automóvel. **Cuidado!** O fecho do cinto do automóvel **10** não se deve encontrar na guia do cinto **12**. Se for este o caso, tente noutro lugar ou experimente montar o assento para criança na posição inclinada (ver 4.2).

- ☞ Certifique-se de que o assento para criança está montado fixamente. Caso contrário, volte a esticar o cinto do automóvel. **Dica!** Puxe o assento para criança para a frente pelo conjunto de cintos. Não deve ser possível deslocá-lo.

1

Istruzioni per l'uso

- ☞ Tenete ferma la cintura diagonale **6** in basso e poi tiratela in avanti sopra il passante **26** per far passare la cintura diagonale **6** allentata.

- ☞ Tirate con forza la parte superiore della cintura diagonale **6**, in modo da tenderla completamente. **Attenzione!** La chiusura della cintura **10** non deve trovarsi in alcun caso nella guida **12**. In tal caso scegliete un altro sedile o cercate di montare il seggiolino nella posizione inclinata all'indietro (vedi 4.2).
- ☞ Assicuratevi che il seggiolino sia montato in modo fisso. In caso contrario tendete nuovamente la cintura. **Consiglio!** Tirate in avanti il seggiolino agendo sulla cintura. Deve spostarsi solo leggermente o niente affatto.

9 - 18 kg



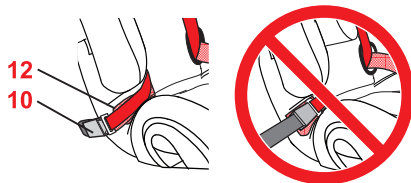
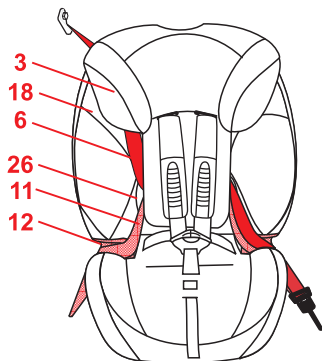

E

Instrucciones de uso

4.4 Montaje correcto del asiento infantil



 Para mayor seguridad del niño, compruebe que:

- el asiento infantil esté bien fijado al vehículo,
- el cinturón de seguridad del vehículo esté tenso y no se haya retorcido,
- el cinturón de la cintura **11** pase por las dos guías rojo claro del cinturón **12**,
- el cinturón diagonal **6** pase por el lado opuesto al broche del cinturón del automóvil **10** entre la pieza lateral **18** y el reposacabezas **3**,
- la lengüeta y el broche del cinturón del automóvil **10** **no** queden dentro de las guías de color rojo claro **12** del cinturón del asiento infantil,



Manual de instruções

4.4 A sua cadeira de criança para automóvel está correctamente montada



Para a segurança da criança, verifique se...

- a cadeira de criança para automóvel está montada de forma fixa no veículo,
- o cinto do automóvel está esticado e não torcido,
- o cinto para a cintura **11** passa por ambas as guias do cinto **12** vermelhas claras,
- o cinto diagonal **6**, do lado oposto ao fecho do cinto do automóvel **10**, passa entre a parte lateral **18** e o apoio para a cabeça **3**,
- as linguetas de fecho e o fecho do cinto do automóvel **10** **não** estão nas guias do cinto **12** vermelhas claras da cadeira de criança para automóvel,



Istruzioni per l'uso

4.4 Corretta installazione del seggiolino da auto



Per la sicurezza del vostro bambino verificate che...

- il seggiolino da auto sia installato saldamente nel veicolo,
- la cintura sia tesa e non attorcigliata,
- la cintura addominale **11** scorra attraverso le due guide di colore rosso chiaro della cintura **12**,
- la cintura diagonale **6** sul lato anteriore la chiusura **10** scorra fra la parte laterale **18** e il poggiatesta **3**,
- la linguetta di chiusura e la chiusura della cintura **10** **non** non siano nelle guide rosso chiaro **12** del seggiolino,



9 - 18 kg



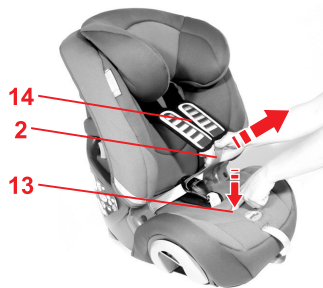
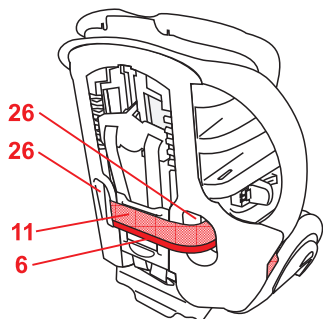

E

Instrucciones de uso

- el cinturón de la cintura **11** y el cinturón diagonal **6** discurren a través de las guías del cinturón **26** del respaldo.

4.5 Distensión de los cinturones

- ☞ Pulse el botón de regulación **13** y tire simultáneamente de ambos cinturones **2** hacia delante.
¡Cuidado! No tire de ellos por la parte acolchada **14**.



Manual de instruções

- o cinto para a cintura **11** e o cinto diagonal **6** passam pelas duas passagens do cinto **26** do encosto.



Istruzioni per l'uso

- la cintura addominale **11** e la cintura diagonale **6** scorrono attraverso le guide **26** dello schienale.



4.5 Desapertar os cintos

- Prima a tecla de ajuste **13** e puxe, simultaneamente, ambos os cintos para os ombros **2** para a frente. **Cuidado!** Não puxar pelas protecções para os ombros **14**.



4.5 Allentamento delle cinture

- Premete il tasto di regolazione **13** e tirate contemporaneamente le due cinture spalle **2** in avanti. **Attenzione!** Non tirate le imbottiture spalle **14**.



4.6 Abrochar el cinturón al niño

- ✧ Afloje los cinturones de los hombros **2** (véase 4.5).
- ✧ Abra el broche del cinturón **15** (presione el pulsador rojo).
- ✧ Introduzca las lengüetas del broche **16** en las gomas de sujeción **26**.
- ✧ Coloque al niño en el asiento infantil.
- ✧ Pase los cinturones **2** sobre los hombros del niño.
¡Cuidado! No retuerza o confunda los cinturones de los hombros **2**.

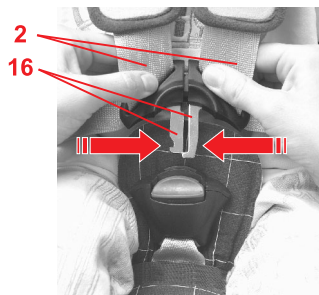
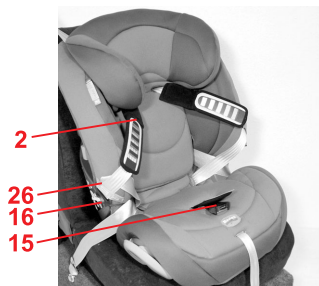

Manual de instruções

4.6 Aperte o cinto de segurança da sua criança



- ✎ Solte os cintos para os ombros **2** (ver 4.5).
- ✎ Abra o fecho do cinto **15** (premir a tecla vermelha).
- ✎ Insira as linguetas de fecho **16** nas borrachas de fixação **26**.
- ✎ Coloque a criança no assento para criança.
- ✎ Coloque os cintos para os ombros **2** por cima dos ombros da criança.
Cuidado! Não torcer **2** ou trocar os cintos para os ombros.
- ✎ Una ambas as linguetas de fecho **16**...

Istruzioni per l'uso

4.6 Allacciamento del vostro bambino



- ✎ Allentate le cinture spalle **2**. (vedi 4.5).
- ✎ Aprite la chiusura della cintura **15** (premendo il tasto rosso).
- ✎ Inserite le linguette di chiusura **16** nei gommini di fissaggio **26**.
- ✎ Collocate il bambino nel seggiolino.
- ✎ Fate passare le cinture **2** sulle spalle del vostro bambino.
Attenzione! Non attorcigliate né scambiate **2** le cinture spalle.
- ✎ Fate passare insieme le due linguette di chiusura **16**...

9 - 18 kg



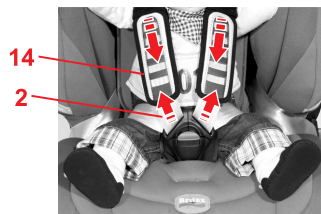
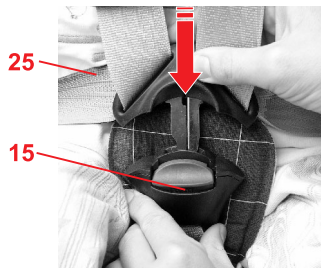

E

Instrucciones de uso

- ✧ Y encájelas en el broche **15** hasta que oiga un CLIC.
- ✧ Tense los cinturones hasta que queden bien ajustados al cuerpo del niño (véase 4.7).
¡Cuidado! Los cinturones de la cadera **25** deben quedar tan tensados como sea posible.

4.7 Tensión de los cinturones

- ✧ Tire del cinturón regulador **17**, hasta que los cinturones queden bien ajustados de forma uniforme al cuerpo del niño.
¡Cuidado! Tire del cinturón regulador **17** hacia fuera lo más recto posible hacia fuera y no hacia un lado o hacia arriba.
- ✧ Tire de la parte acolchada **14** hasta que vuelva a estar abajo.
- ✧ Tire de los cinturones de los hombros **2** para asegurarse de que los cinturones de la cadera **25** están tensos y los cinturones están colocados de forma uniforme.
- ✧ Vuelva a tirar del cinturón regulador **17**, hasta que los cinturones queden bien ajustados de forma uniforme al cuerpo del niño.

Q

Manual de instruções

- ✎ ...e encaixe-as de forma audível no fecho do cinto **15**. CLIQUE!
- ✎ Estique os cintos até que estejam ajustados ao corpo da criança (ver 4.7).
Cuidado! Os cintos para a cintura **25** têm de passar o mais justo possível por cima da região inguinal da criança.

4.7 Apertar os cintos

- ✎ Puxe pelo cinto de ajuste **17**, até o conjunto de cintos assentar de forma uniforme e junto ao corpo da sua criança.
Cuidado! Puxe pelo cinto de ajuste **17** sempre o mais em linha recta possível, não puxe lateralmente ou para cima.
- ✎ Volte a puxar a protecção para os ombros **14** para baixo.
- ✎ Puxe os cintos para os ombros **2**, para garantir que os cintos para a cintura **25** estão esticados e que o conjunto de cintos assenta de modo uniforme.
- ✎ Volte a puxar pelo cinto de ajuste **17**, até o conjunto de cintos assentar de forma uniforme e junto ao corpo da sua criança.

I

Istruzioni per l'uso

- ✎ ... e fatele scattare nella chiusura della cintura **15** in modo percettibile. Dovreste udire un "clic!".
- ✎ Tendete le cinture fino a farle aderire bene al corpo del vostro bambino (vedi 4.7).
Attenzione! Le cinture gambe **25** devono passare il più in basso possibile sull'inguine del vostro bambino.

4.7 Tensionamento delle cinture

- ✎ Tirate la cintura regolabile **17** finché non aderisce bene e uniformemente al corpo del bambino.
Attenzione! Tirate la cintura regolabile **17** possibilmente in direzione diretta e non lateralmente o verso l'alto.
- ✎ Tirate le imbottiture spalle **14** nuovamente verso il basso.
- ✎ Tirate le cinture spalle **2** per assicurarvi che le cinture gambe **25** siano ben tese e aderiscano in modo uniforme.
- ✎ Tirate nuovamente la cintura regolabile **17** finché non aderisce bene e uniformemente al corpo del bambino.

9 - 18 kg



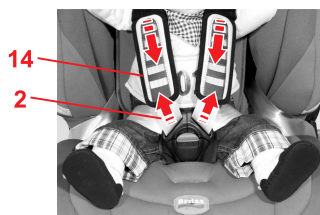
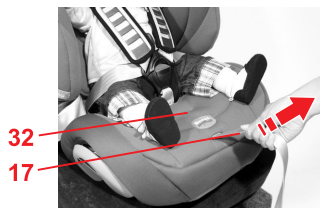

E

Instrucciones de uso

EVOLVA 1-2-3 plus : Tensión de los cinturones con Click & Safe™



Click & Safe

👉 Tire del cinturón regulador **17**, hasta que oiga claramente un clic en la marca de tensado del cinturón **32**.

Un consejo: tire del cinturón regulador **17** hacia fuera lo más recto posible hacia fuera y no hacia un lado o hacia arriba.

👉 Tire de la parte acolchada **14** hasta que vuelva a estar abajo.

👉 Tire de los cinturones de los hombros **2** para asegurarse de que los cinturones de la cadera **25** están tensos y los cinturones están colocados de forma uniforme.

👉 Vuelva a tirar del cinturón regulador **17** hasta que oiga un clic.



Manual de instruções

EVOLVA 1-2-3 plus : **Esticar os cintos com Click & Safe™**



Click & Safe

- ☞ Puxe o cinto de ajuste **17**, até ouvir um clique nítido do indicador de tensão do cinto **32**.
Dica! Puxe pelo cinto de ajuste **17** sempre o mais em linha recta possível, não puxe lateralmente ou para cima.

- ☞ Volte a puxar a protecção para os ombros **14** para baixo.
- ☞ Puxe os cintos para os ombros **2**, para garantir que os cintos para a cintura **25** estão esticados e que o conjunto de cintos assenta de modo uniforme.
- ☞ Puxe novamente o cinto de ajuste **17** até ouvir um clique.



Istruzioni per l'uso

EVOLVA 1-2-3 plus : **Tensionamento delle cinture con Click & Safe™**



Click & Safe

- ☞ Tirate la cintura regolabile **17** finché l'indicatore di tensione **32** non emette un "clac" perfettamente percepibile.
Consiglio! Tirate la cintura regolabile **17** possibilmente in direzione diretta e non lateralmente o verso l'alto.

- ☞ Tirate le imbottiture spalle **14** nuovamente verso il basso.
- ☞ Tirate le cinture spalle **2** per assicurarsi che le cinture gambe **25** siano ben tese e aderiscano in modo uniforme.
- ☞ Tirate nuovamente la cintura regolabile **17** finché non udite un clic.



4.8 Protección perfecta del niño



Para mayor seguridad del niño, compruebe que:

- los cinturones del asiento infantil estén bien ajustados al cuerpo del niño pero sin oprimirle,
- los cinturones de los hombros **2** estén bien colocados,
- los cinturones **no** estén retorcidos,
- las lengüetas de broche **16** estén bien encajadas en el broche del cinturón **15**,
- la parte acolchada **14** esté bien ajustada al cuerpo.

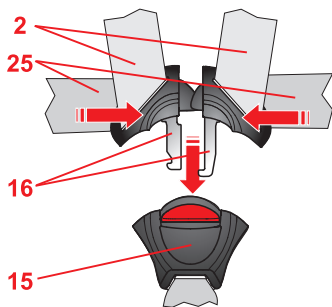

2

Manual de instruções

4.8 Assim a criança está correctamente protegida



Para a segurança da criança, verifique se...

- os cintos da cadeira de criança para automóvel se encontram ajustados ao corpo, sem suspender a criança,
- os cintos para os ombros **2** estão bem ajustados,
- os cintos **não** estão torcidos,
- as linguetas do fecho **16** no fecho do cinto **15** estão encaixadas.
- as protecções para os ombros **14** se encontram correctamente ajustadas ao corpo.

1

Istruzioni per l'uso

4.8 Corretto posizionamento del vostro bambino



Per la sicurezza del vostro bambino verificate che...

- le cinture del seggiolino da auto aderiscano al corpo, senza comprimere il bambino,
- le cinture spalle **2** siano regolate correttamente,
- le cinture **non** si siano attorcigliate,
- le linguette di chiusura **16** siano incastrate nella chiusura della cintura **15**,
- le imbottiture spalle **14** aderiscano correttamente al corpo.

9 - 18 kg



E

Instrucciones de uso

5. Utilización del asiento infantil para vehículos para niños con un peso corporal de 15 a 36 kg



5.1 Desinstalación del cinturón de 5 puntos

- ✧ Afloje los cinturones al máximo (véase 4.5).
- ✧ Empuje el regulador de altura del cinturón **1** hacia arriba al máximo (véase 4.1).
- ✧ Retire los cinturones de los hombros **2** de la pieza de unión **22**.
- ✧ Enganche la pieza de unión **22**, en la parte inferior del respaldo **29**, en su soporte **30**.
- ✧ Extraiga los pasadores de las partes acolchadas **14** de la varilla **28** del regulador de altura del cinturón **1** tirando de ellos hacia abajo.
- ✧ Retire los cinturones **2** y los pasadores, situados en la parte acolchada **14**, de las ranuras.
- ✧ Despegue el cierre de velcro del acolchado ajustable **23** y extráigalo.

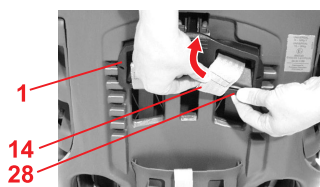
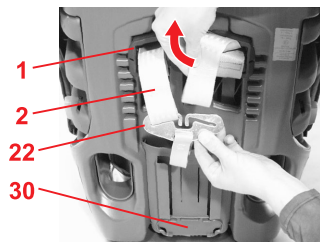

P

Manual de instruções

5. Utilização da cadeira de criança para automóvel para crianças com um peso de 15 - 36 kg



5.1 Desmontagem do conjunto de cintos de 5 pontos de fixação

- ✎ Solte os cintos o máximo possível (ver 4.5).
- ✎ Desloque o dispositivo de ajuste da altura do cinto **1** totalmente para cima (ver 4.1).
- ✎ Levante os cintos para os ombros **2** da peça de ligação **22**.
- ✎ Encaixe a peça de ligação **22**, por baixo do encosto **29**, no seu dispositivo de fixação **30**.
- ✎ Desloque para baixo as corredeiras do cinto da protecção para os ombros **14** da presilha **28** do dispositivo de ajuste da altura do cinto **1**.
- ✎ Puxe o cinto para os ombros **2** e as corredeiras do cinto da protecção para os ombros **14** para fora das ranhuras do cinto.
- ✎ Abra o fecho de feltro na protecção da união dos cintos **23** e retire-o.

I

Istruzioni per l'uso

5. Utilizzo del seggiolino da auto per bambini con peso corporeo di 15 - 36 kg



15 - 36 kg

5.1 Smontaggio della cintura a 5 punti

- ✎ Allentate le cinture il più possibile (vedi 4.5).
- ✎ Spostare in alto il regolatore in altezza delle cinture **1** (vedi 4.1).
- ✎ Sganciate le cinture spalle **2** dalla parte di collegamento **22**.
- ✎ Agganciate la parte di collegamento **22**, in basso sullo schienale **29**, al supporto **30**.
- ✎ Spingete gli occhielli dell'imbottitura spalle **14** dall'anima **28** del regolatore in altezza delle cinture **1** verso il basso.
- ✎ Estraiete le cinture spalle **2** e gli occhielli dell'imbottitura spalle **14** dai passanti della cintura.
- ✎ Aprite la chiusura in velcro dell'imbottitura del bacino **23** ed estraiete quest'ultima.



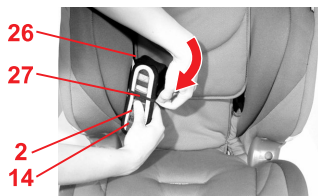
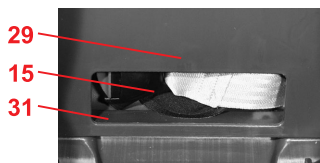
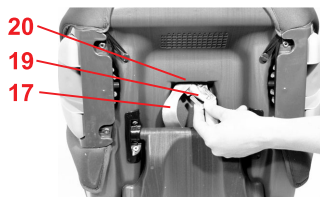

E

Instrucciones de uso

- ✎ Retire el cinturón regulador **17** de la placa de metal **19**.
- ✎ Empuje lateralmente la placa de metal **19**, con la que se sujeta el broche **15** al asiento, a través de la ranura **20**.
- ✎ Vuelva a abrir el broche del cinturón **15**.

- ✎ Deslice los cinturones con las lengüetas de broche **16** a través de las ranuras del cinturón de la funda.
- ✎ Coloque el broche del cinturón **15** debajo de la funda en el compartimento **31** del respaldo **29**.

- ✎ Introduzca el cinturón regulador **17** debajo de la funda.
- ✎ Sujete la parte acolchada **14** y los cinturones de los hombros **2** en los bucles de goma **27** de las guías del cinturón **26**.



Manual de instruções

- ✂ Retire os cintos de ajuste **17** da placa de metal **19**.
- ✂ Desloque a placa de metal **19**, com a qual o fecho do cinto **15** está fixo à concha do assento de canto pela ranhura do cinto **20**.
- ✂ Abra o fecho do cinto **15**.

- ✂ Introduza os cintos com as linguetas de fecho **16** através das ranhuras do cinto para a cintura do revestimento.
- ✂ Coloque o fecho do cinto **15** por baixo do revestimento no compartimento de arrumação **31** no encosto **29**.

- ✂ Introduza o cinto de ajuste **17** por baixo do revestimento.
- ✂ Fixe a protecção para os ombros **14** e os cintos para os ombros **2** nas corredeiras de borracha **27** nas passagens dos cintos **26**.



Istruzioni per l'uso

- ✂ Sganciate la cintura regolabile **17** dalla piastra metallica **19**.
- ✂ Spingete di taglio la piastra metallica **19**, con la quale è fissata la chiusura della cintura **15** della poltroncina, attraverso il passante della cintura **20**.
- ✂ Aprite la chiusura della cintura **15**.

- ✂ Inserite le cinture con le linguette di chiusura **16** attraverso il passante della cintura addominale del rivestimento.
- ✂ Inserite la chiusura della cintura **15** sotto il rivestimento nel vano portaoggetti **31** nello schienale **29**.

- ✂ Inserite la cintura regolabile **17** sotto il rivestimento.
- ✂ Fissate le imbottiture spalle **14** e le cinture spalle **2** negli occhielli di gomma **27** sui passanti della cintura **26**.

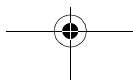

5.2 Regulación de la altura del reposacabezas

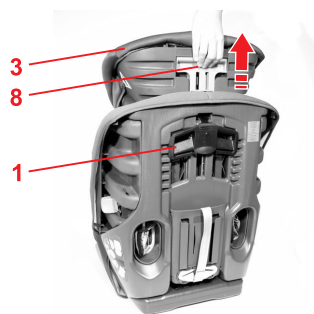
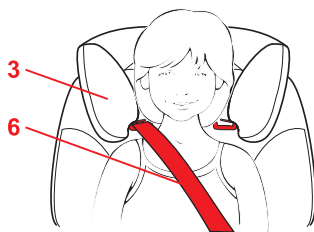

Un reposacabezas adaptado correctamente **3** garantiza la disposición óptima del cinturón diagonal **6**, y le ofrece a su niño la protección y el confort deseados. Puede regular la altura del reposacabezas **3** en 5 posiciones distintas.

- El reposacabezas **3** debe ajustarse de forma tal que entre los hombros del niño y el reposacabezas **3** queden aún dos dedos de anchura.

Para ajustar la altura del reposacabezas **3 al tamaño del niño, proceda del siguiente modo:**

- ✎ Regule el regulador de altura del cinturón **1** hasta la posición más alta (véase 4.1).
- ✎ Deje que el niño tome asiento en el asiento infantil.
- ✎ Inserte la mano en la parte trasera del reposacabezas **3** y tire del regulador del reposacabezas **8** hacia arriba. Ahora el reposacabezas **3** está desbloqueado.
- ✎ Ahora puede regular el reposacabezas **3** desbloqueado a la altura deseada. Tan pronto como suelte el regulador del reposacabezas **8**, se encaja el reposacabezas **3**.



Manual de instruções

5.2 Ajuste em altura do apoio para a cabeça



Um apoio para a cabeça correctamente ajustado **3** garante um correr óptimo do cinto diagonal **6** e proporciona à sua criança a protecção e o conforto desejados. Pode encaixar a altura do apoio para a cabeça **3** em 5 posições.

- O apoio para a cabeça **3** tem de estar ajustado de forma que entre os ombros da criança e o apoio para a cabeça **3** ainda exista a largura de dois dedos.

Pode ajustar a altura dos apoios para a cabeça **3** à altura do corpo da criança:

- ✎ Desloque o dispositivo de ajuste da altura do cinto **1** para a sua posição superior (ver 4.1).
- ✎ Deixe que a criança se sente no assente para criança.
- ✎ Agarre na parte posterior do apoio de cabeça **3** e puxe o regulador dos apoios para a cabeça **8** para cima. Agora o apoio para a cabeça **3** está desbloqueado.
- ✎ Agora pode ajustar o apoio para a cabeça desbloqueado **3** para a altura desejada. Logo que soltar o regulador dos apoios para a cabeça **8**, o apoio para a cabeça **3** encaixa.



Istruzioni per l'uso

5.2 Regolazione in altezza del poggiatesta



Un poggiatesta adattato correttamente **3** assicura lo scorrimento ottimale della cintura diagonale **6** e offre al vostro bambino la protezione e il comfort desiderati. Potete bloccare l'altezza del poggiatesta **3** in 5 posizioni.

- Il poggiatesta **3** deve essere regolato in modo tale che tra le spalle del vostro bambino e il poggiatesta **3** sia presente uno spazio di due dita di larghezza.

Potete adattare l'altezza del poggiatesta **3** alle dimensioni del vostro bambino come indicato di seguito:

- ✎ Spostate il regolatore in altezza delle cinture **1** nella posizione superiore (vedi 4.1).
- ✎ Fate prendere posto al vostro bambino sul seggiolino.
- ✎ Afferrate il lato posteriore del poggiatesta **3** e tirate il regolatore **8** verso l'alto. Ora il poggiatesta **3** è sbloccato.
- ✎ A questo punto potete regolare il poggiatesta sbloccato **3** all'altezza desiderata. Non appena rilasciate il regolatore **8**, il poggiatesta **3** si blocca.



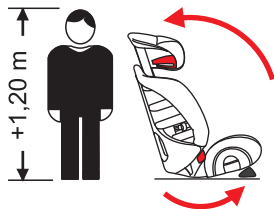

E

Instrucciones de uso

5.3 Ajuste de la inclinación del asiento infantil para vehículos



El asiento infantil se puede ajustar con dos inclinaciones distintas como se describe en 4.2.



¡Cuidado! Para niños con una altura superior a 1,20 m, el EVOLVA 1-2-3 sólo debe utilizarse en posición reclinada con la cuña distanciadora **21** delante.

5.4 Abrochar el cinturón al niño



Para asegurar al niño y el asiento con el cinturón de 3 puntos de su vehículo, proceda del siguiente modo:



1. Abrochar el cinturón de seguridad

☞ Coloque el asiento infantil sobre el asiento del vehículo.

¡Cuidado! Para niños de más de 1,20 m de altura, el asiento infantil sólo debe utilizarse en posición reclinada con la cuña distanciadora **21** delante (véase 5.3).

Manual de instruções

5.3 Ajuste da inclinação da cadeira de criança para automóvel



Desta forma, o assento para criança pode ser ajustado com duas inclinações, conforme descrito em 4.2.



Cuidado! Para crianças com mais de 1,20 m de altura, o EVOLVA 1-2-3 apenas pode ser utilizado na posição inclinada com a cunha espaçadora **21** à frente.

5.4 Aperte o cinto de segurança do seu filho



Segure a sua criança e o seu assento para criança com o cinto de 3 pontos de fixação do seu veículo da seguinte forma:



1. Colocar o cinto do automóvel

Coloque a cadeira de criança no assento do automóvel.

Cuidado! No caso de crianças com mais de 1,20 m de altura, utilize o assento para criança apenas na posição inclinada com a cunha espaçadora **21** à frente (ver 5.3).

Istruzioni per l'uso

5.3 Regolazione dell'inclinazione del seggiolino da auto



Potete regolare il seggiolino in due inclinazioni come descritto al punto 4.2.



Attenzione! Per i bambini oltre 1,20 m di altezza utilizzare l'EVOLVA 1-2-3 solo in posizione inclinata all'indietro con il cuneo distanziale **21** davanti.

5.4 Allacciamento del vostro bambino



Fissate il bambino nel seggiolino con la cintura a 3 punti come riportato di seguito:



1. Applicare la cintura.

Collocate il seggiolino sul sedile.

Attenzione! Per i bambini oltre 1,20 m di altezza, utilizzate il seggiolino solo in posizione inclinata all'indietro con il cuneo distanziale **21** davanti (vedi 5.3).



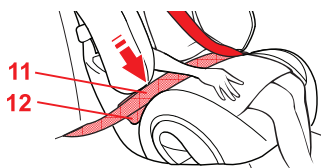
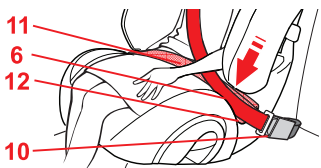
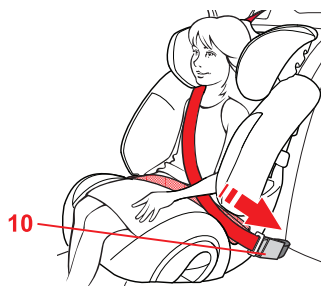

E

Instrucciones de uso

- ❏ Deje que el niño tome asiento en el asiento infantil.
- ❏ Tire del cinturón de seguridad y abróchelo pasando el cinturón por delante del niño **10**.
¡Cuidado! No retuerza el cinturón.
- ❏ Introduzca la lengüeta en el broche del cinturón del vehículo **10**. CLIC

2. Introduzca el cinturón de seguridad por las guías rojas del asiento infantil.

- ❏ Sitúe el cinturón diagonal **6** y el cinturón de la cintura **11** del lado del broche del cinturón del vehículo **10** en la guía de color rojo claro del cinturón **12**.
¡Cuidado! El broche del cinturón del vehículo **10** no debe estar sobre la guía roja clara **12**.
- ❏ Coloque el cinturón de la cintura **11** por el otro lado, también en la guía roja clara **12**.
¡Cuidado! El cinturón de pelvis **11** debe pasar lo más bajo posible por encima del pliegue inguinal del niño en ambos lados.

Manual de instruções

- ✘ Deixe que a criança se sente no assente para criança.
- ✘ Puxe para fora o cinto do automóvel e passe-o pela frente da criança e no fecho do cinto do automóvel **10**.
Cuidado! Não torcer o cinto.
- ✘ Encaixe as linguetas de fecho no fecho do cinto do automóvel **10**. CLIQUE!

2. Colocar o cinto do automóvel nas guias do cinto vermelhas na cadeira de criança.

- ✘ Passe o cinto diagonal **6** e o cinto para a cintura **11**, do lado do fecho do cinto do automóvel **10** pela guia do cinto **12** vermelha clara.
Cuidado! O fecho do cinto de segurança **10** não pode estar sobre a guia vermelha do cinto **12**.
- ✘ Coloque o cinto para a cintura **11** do outro lado também na guia do cinto **12** vermelha clara.
Cuidado! O cinto para a cintura **11** tem de passar o mais justo possível por cima da região inguinal da criança.

Istruzioni per l'uso

- ✘ Fate prendere posto al vostro bambino sul seggiolino.
- ✘ Estraiete la cintura e fatela passare davanti al vostro bambino verso la relativa chiusura. **10**.
Attenzione! Non attorcigliate la cintura.
- ✘ Fate scattare la linguetta nella chiusura della cintura **10**. Dovreste udire un "clic!".

2. Inserite la cintura nelle guide rosse della cintura del seggiolino.

- ✘ Inserite cintura diagonale **6** e cintura addominale **11** sul lato della chiusura **10** nelle guide rosso chiaro **12**.
Attenzione! La chiusura della cintura dell'auto **10** non deve trovarsi nella guida di colore rosso chiaro della cintura **12**.
- ✘ Inserite anche la cintura addominale **11** sull'altro lato nella guida rosso chiaro **12**.
Attenzione! La cintura addominale **11** deve passare, su entrambi i lati, il più in basso possibile sull'inguine del vostro bambino.



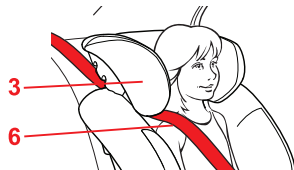
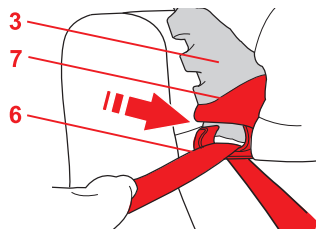

E

Instrucciones de uso

- ✚ Pase el cinturón diagonal **6** por el soporte de color rojo oscuro **7** del reposacabezas **3**, hasta que se deslice por detrás de la lengüeta de bloqueo **7**.

- ✚ Asegúrese de que el cinturón diagonal **6** pasa por encima de la clavícula del niño, y no está en contacto con el cuello.
Un consejo: También puede adaptar la altura del reposacabezas **3** a la altura del vehículo.
- ✚ **¡Cuidado!** El cinturón diagonal **6** debe estar dispuesto hacia atrás de forma transversal.
Un consejo: Puede regular el cinturón con desviador del cinturón regulable de su vehículo.
- ✚ **¡Cuidado!** El cinturón diagonal **6** no puede llevar hacia adelante en dirección al desviador del cinturón.
Un consejo: Intente usar el asiento infantil en otro asiento posterior.
- ✚ Tense el cinturón de seguridad tirando del cinturón diagonal **6**.



Manual de instruções

- ✘ Passe o cinto diagonal **6** pelo suporte do cinto **7** vermelho escuro do apoio para a cabeça **3**, até ele se encontrar totalmente no suporte do cinto sem estar torcido **7**.

- ✘ Certifique-se de que o cinto diagonal **6** passa pela clavícula da criança e não pelo pescoço.
Dica! Pode ajustar o apoio para a cabeça **3** na altura, mesmo dentro do veículo.

- ✘ **Cuidado!** O cinto diagonal **6** tem de passar para trás diagonalmente.
Dica! Pode regular a passagem do cinto com o dispositivo de desvio regulável do cinto do seu veículo.

- ✘ **Cuidado!** O cinto diagonal **6** nunca deve passar pela frente para o dispositivo de desvio do cinto no automóvel.
Dica! Neste caso, tente outro lugar no assento traseiro.

- ✘ Estique o cinto do automóvel, enquanto puxa o cinto diagonal **6**.



Istruzioni per l'uso

- ✘ Inserite la cintura diagonale **6** nel supporto della cintura di colore rosso scuro **7** del poggiatesta **3**, in modo tale che la cintura venga a trovarsi completamente inserita in posizione non attorcigliata nel supporto **7**.

- ✘ Accertatevi che la cintura diagonale **6** scorra sulla clavícula del vostro bambino e non si trovi in corrispondenza della gola.
Consiglio! Potete regolare in altezza il poggiatesta **3** anche in auto.

- ✘ **Attenzione!** La cintura diagonale **6** deve scorrere all'indietro trasversalmente.
Consiglio! Potete regolare lo scorrimento della cintura con l'avvolgitore regolabile della cintura della vostra auto.

- ✘ **Attenzione!** La cintura diagonale **6** non deve mai essere fatta passare davanti per arrivare all'avvolgitore della cintura dell'auto.
Consiglio! In questo caso scegliete un altro posto sul sedile posteriore.

- ✘ Tendete la cintura, tirando la cintura diagonale **6**.



15 - 36 kg



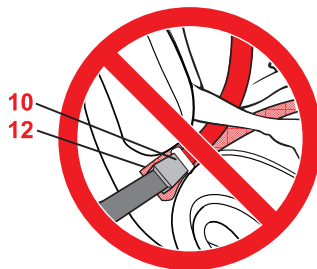
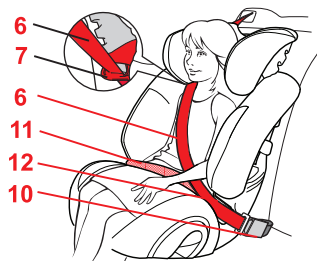

E

Instrucciones de uso

5.5 Protección perfecta del niño

 **Para mayor seguridad del niño, compruebe que:**

- el cinturón de la cintura **11** pasa por ambos lados por las guías rojo claro **12**,
- el cinturón diagonal **6** del lado del broche del cinturón de seguridad del automóvil **10** también pasa por la guía rojo claro **12**,
- el cinturón diagonal **6** pasa a través del soporte del cinturón rojo oscuro **7** del reposacabezas **3**,
- el cinturón diagonal **6** pasa hacia atrás de forma transversal,
- los cinturones están tensados y no retorcidos,
- el broche del cinturón del vehículo **10** no debe estar sobre la guía roja clara **12** ni sobre el asiento.

Manual de instruções

5.5 Assim a criança está correctamente protegida

Para a segurança da criança, verifique se...

- o cinto para a cintura **11** passa em ambos os lados nas guias do cinto **12** vermelhas claras,
- o cinto diagonal **6** no lado do fecho do cinto do automóvel **10** também passa na guia do cinto **12** vermelha clara,
- o cinto diagonal **6** passa pelo suporte do cinto **7** vermelho escuro do apoio para a cabeça **3**,
- o cinto diagonal **6** passa para trás na diagonal,
- os cintos estão apertados e não torcidos,

- o fecho do cinto do automóvel **10** não pode estar sobre a guia do cinto **12** vermelha clara ou a concha do assento.



Istruzioni per l'uso

5.5 Corretto posizionamento del vostro bambino

Per la sicurezza del vostro bambino verificate che...

- la cintura addominale **11** scorra su entrambi i lati all'interno delle guide di colore rosso chiaro **12**,
- la cintura diagonale **6** scorra sul lato della chiusura della cintura **10** sempre all'interno della guida di colore rosso chiaro **12**,
- la cintura diagonale **6** scorra attraverso il supporto di colore rosso scuro **7** del poggiatesta **3**,
- la cintura diagonale **6** scorra all'indietro trasversalmente,
- le cinture siano tese e non si siano attorcigliate,

- la chiusura della cintura **10** non deve trovarsi nella guida di colore rosso chiaro **12** o nella poltroncina.



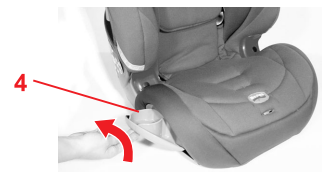
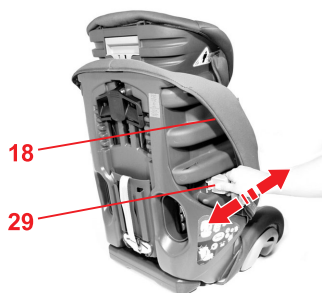

6. EVOLVA 1-2-3 plus : Regulación de la anchura del respaldo

Es posible regular la anchura del respaldo 29 del Evolva 1-2-3 plus.

↗ Deslice los dos reguladores de anchura gris claro 24 en la parte exterior de las piezas laterales 18 hacia delante o hacia atrás hasta alcanzar la posición deseada.

- **hacia atrás:** el asiento se ensancha
- **hacia delante:** el asiento se estrecha

7. Empleo de los portabebidas desplegados

¡Cuidado! Para prevenir lesiones, no utilice nunca los portabebidas para

- líquidos calientes
- objetos cortantes o puntiagudos (p. ej. lapiceros)
- objetos duros y pesados (p. ej. botellas de aluminio)

↗ Mueva hacia arriba y hacia fuera el portabebidas 4 hasta que encaje.

Manual de instruções

6. EVOLVA 1-2-3 plus : Ajuste da largura do encosto

Pode regular a largura do encosto 29 do Evolva 1-2-3 plus.

- ✎ Desloque os dois reguladores da largura **24** cinzentos claros no lado exterior das partes laterais **18** para a frente ou para trás até à posição pretendida.
- **para trás:** o assento fica mais largo
 - **para a frente:** o assento fica mais estreito

7. Utilização do suporte para bebidas giratório

Cuidado! Para evitar ferimentos, nunca utilize as superfícies de apoio para...

- líquidos quentes
 - objectos afiados ou pontiagudos (p.ex., lápis)
 - objectos duros e pesados (p.ex., garrafas de alumínio)
- ✎ Rode o suporte para bebidas **4** para cima e para fora, até este encaixar.

Istruzioni per l'uso

6. EVOLVA 1-2-3 plus : **Regolazione della larghezza dello schienale**

Lo schienale 29 dell'Evolva 1-2-3 plus può essere regolato in larghezza.

- ✎ Spingete i due regolatori grigio chiaro **24** sul lato esterno delle parti laterali **18** avanti o indietro nella posizione desiderata.
- **indietro:** il seggiolino si allarga
 - **avanti:** il seggiolino si restringe

7. Uso del portabevande girevole

Attenzione! Per evitare lesioni, non utilizzate mai i piani di appoggio per...

- liquidi bollenti
- oggetti affilati o appuntiti (ad es. matite)
- oggetti duri e pesanti (ad es. bottiglie in alluminio)

- ✎ Spostate il portabevande **4** verso l'alto e l'esterno finché non scatta in posizione.





E

Instrucciones de uso

8. Instrucciones de mantenimiento



Para mantener el efecto protector

- En un accidente a una velocidad de colisión de más de 10 km/h pueden producirse daños en el asiento infantil para vehículos que no siempre pueden apreciarse a simple vista. En este caso, deberá sustituirse el asiento infantil. Elimínelo, por favor, de forma correcta (véase el punto 9).
- Controle regularmente si las piezas importantes están dañadas. Asegúrese de que todas las piezas mecánicas funcionan sin problemas.
- Compruebe que el asiento infantil no quede aprisionado entre piezas duras (puerta del vehículo, raíles del asiento, etc.), ya que podría dañarse.
- Cuando el asiento esté dañado (p. ej. tras una caída), es imprescindible que el fabricante lo examine.
- No utilice nunca grasas o aceites para lubricar las piezas del asiento infantil.



8. Instruções de conservação



Para obtenção do efeito de protecção

- Em caso de acidente a uma velocidade de colisão superior a 10 km/h podem ocorrer danos na cadeira de criança para automóvel, que podem não ser evidentes. Neste caso a cadeira de criança para automóvel tem de ser substituída. Elimine-a de forma adequada (ver 9.).
- Verifique regularmente todas as peças importantes quanto a danos. Certifique-se de que os componentes mecânicos funcionam de forma impecável.
- Tenha atenção para que a cadeira de criança para automóvel não esteja presa entre duas peças duras (porta do veículo, calha do assento etc.) e fique danificada.
- Uma cadeira de criança para automóvel danificada (p.ex. após uma queda) tem de ser reparada no fabricante.
- Nunca lubrifique as peças do assento para crianças.



8. Istruzioni di manipolazione



Per conservare l'azione protettiva

- In caso di incidente ad una velocità di collisione superiore ai 10 km/h, possono essersi verificati danni al seggiolino, che non necessariamente sono visibili. In tal caso il seggiolino deve essere sostituito. Eseguite un adeguato smaltimento (vedi. 9).
- Verificate regolarmente l'eventuale presenza di danni su tutte le parti importanti. Accertatevi che i componenti meccanici funzionino perfettamente.
- Fate attenzione che il seggiolino non venga schiacciato tra parti dure (portiera dell'auto, guide dei sedili, ecc.) e conseguentemente danneggiato.
- Fate assolutamente controllare dal produttore il seggiolino se risulta danneggiato (ad es. dopo una caduta).
- Non lubrificate o oliate mai i componenti del seggiolino.





E

Instrucciones de uso

- Cuando no utilice el asiento infantil, guárdelo en un lugar seguro. No coloque objetos pesados sobre él. No lo deje nunca cerca de fuentes directas de calor ni expuesto a la luz solar directa.



8.1 Mantenimiento del broche del cinturón

El funcionamiento del broche del cinturón contribuye esencialmente a la seguridad del niño. En general, los problemas de funcionamiento del broche del cinturón son debidos a la suciedad.

Problemas de funcionamiento

- Las lengüetas salen lentamente al presionar el pulsador rojo.
- Las lengüetas no encajan (se salen del broche).
- Las lengüetas encajan sin que suene un "clic" claro.
- Las lengüetas encuentran resistencia al ser introducidas.
- El broche sólo se abre ejerciendo mucha fuerza.

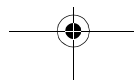
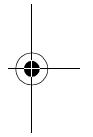
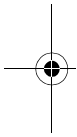



Manual de instruções

- Guarde o assento para criança num local seguro quando este não estiver a ser utilizado. Não coloque objectos pesados sobre ela. Nunca o guarde na proximidade de fontes de calor ou luz solar directas.

8.1 Conservação do fecho do cinto

O funcionamento do fecho do cinto contribui substancialmente para a segurança. Avarias de funcionamento no fecho do cinto atribuem-se, na maioria das vezes, a sujidade.

Avaria de funcionamento

- As linguetas do fecho são ejectadas ao premir retardadamente a tecla vermelha.
- As linguetas do fecho não encaixam (encontram-se de novo ejectadas).
- As linguetas do fecho encaixam sem um "clique" claro.
- As linguetas do fecho são travadas ao introduzir (pastoso).
- O fecho do cinto só abre exercendo muita força.

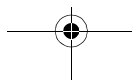
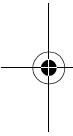

Istruzioni per l'uso

- Quando non viene utilizzato, conservate il seggiolino in un posto sicuro. Non mettere sopra oggetti pesanti. Non immagazzinate mai il seggiolino in prossimità di sorgenti di calore dirette o esporlo alle irradiazioni solari.

8.1 Manipolazione della chiusura della cintura

Il perfetto funzionamento della chiusura della cintura è fondamentale per la sicurezza.

Le anomalie di funzionamento della chiusura sono per lo più riconducibili alla presenza di sporco.

Anomalia di funzionamento

- Se si preme il tasto rosso, le linguette di chiusura vengono espulse con estrema lentezza.
- Le linguette non scattano più in posizione (vengono riespulse).
- Le linguette scattano in posizione in modo impercettibile.
- Durante l'inserimento le linguette vengono ostacolate (frenate).
- La chiusura della cintura può essere aperta solo esercitando una pressione elevata.

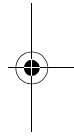

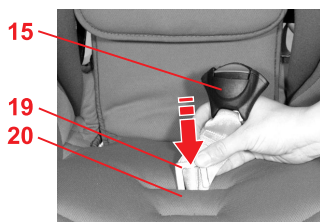

E

Instrucciones de uso

Posible solución

Lave el broche del cinturón de la siguiente manera para que vuelva a funcionar con normalidad:

1. Desmonte el broche (véase 5.1)
2. Lave el broche
 - ✎ Deje el broche **15** durante al menos 1 hora en agua caliente con una solución jabonosa suave. Enjuáguelo y déjelo secar bien.
3. Monte el broche.
 - ✎ Desplace lateralmente la placa metálica **19** de arriba hacia abajo a través de la ranura **20** de la funda y del asiento. Tire con fuerza del broche **15** para **comprobar la sujeción**.
 - ✎ Fije el acolchado ajustable **23**.

Problemas de funcionamiento

- No es posible introducir las lengüetas del broche **16** en el broche del cinturón **15**.

Posible solución

- ✎ Presione el pulsador rojo para desbloquear el broche del cinturón **15**.



Manual de instruções

Solução

Pode lavar o fecho do cinto para que volte a funcionar da seguinte forma:

1. Desmontar fecho do cinto (ver 5.1)
2. Lavar fecho do cinto
 - ✂ Coloque o fecho do cinto **15** pelo menos 1 hora em água quente com sabão. De seguida, enxagúe e deixe-o secar bem.
3. Montar fecho do cinto
 - ✂ Desloque a placa de metal **19** de canto de cima para baixo pela ranhura do cinto **20** no revestimento **e pela concha do assento**. Puxe com força no fecho do cinto **15** para verificar **a fixação**.
 - ✂ Fixe a protecção da união dos cintos **23**.

Avaria de funcionamento

- As linguetas do fecho **16** já não entram no fecho do cinto **15**.

Solução

- ✂ Prima a tecla vermelha para desbloquear o fecho do cinto **15**.



Istruzioni per l'uso

Rimedio

Affinché la chiusura della cintura funzioni di nuovo perfettamente, potete lavarla come riportato di seguito:

1. Smontate la chiusura (vedi 5.1)
2. Lavate la chiusura
 - ✂ Lasciate in ammollo la chiusura **15** almeno per 1 ora in acqua calda con soluzione di sapone delicato. Risciacquatela e fatela asciugare completamente.
3. Montaggio della chiusura della cintura
 - ✂ Spingete di taglio la piastra metallica **19** dall'alto verso il basso attraverso il passante della cintura **20** nel rivestimento **e attraverso la poltroncina**. Tirate energicamente la chiusura della cintura **15** per **controllare il fissaggio**.
 - ✂ Fissate l'imbottitura del bacino **23**.

Anomalia di funzionamento

- Non è più possibile inserire le linguette **16** nella chiusura della cintura **15**.

Rimedio

- ✂ Premete il tasto rosso per sbloccare la chiusura della cintura **15**.



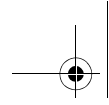

8.2 Limpieza

Asegúrese de utilizar únicamente una funda de repuesto original Britax, ya que la funda constituye un elemento esencial de la funcionalidad del sistema. Puede adquirir repuestos en tiendas especializadas.



El asiento infantil **no debe usarse sin funda**.

- Puede retirar la **funda** y lavarla con un detergente suave a 30° C en la lavadora. Preste atención a las instrucciones en la etiqueta con las instrucciones de lavado de la funda. Si lava a más de 30° C puede decolorarse la tela de la funda. No centrifugue la funda y no la seque nunca en una secadora eléctrica (la funda podría separarse del acolchado).
- Las **piezas de plástico** pueden lavarse con una solución jabonosa. **No** utilice productos agresivos (p. ej. disolventes).
- Los **cinturones** pueden lavarse con una solución jabonosa en agua templada.
¡Cuidado! No extraiga las lengüetas de broche **16** de los cinturones.

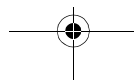
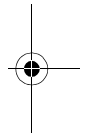
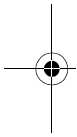



8.2 Limpeza

Preste atenção para só colocar um revestimento sobressalente original Britax pois o revestimento representa uma parte essencial do funcionamento do sistema. Pode obter as peças sobressalentes num revendedor especializado.



A cadeira de criança para automóvel não **deve ser utilizada** sem revestimento.

- Pode retirar o **revestimento** e lavá-lo na máquina com detergente suave, no modo delicado a 30°C. Siga as instruções na etiqueta de lavagem do revestimento. Se lavar a mais de 30 °C, é possível que ocorra o tingimento do tecido do revestimento. Não centrifugar o revestimento e nunca o secar numa máquina de secar roupa (o tecido pode soltar-se do estofamento).
- As **peças em material sintético** podem ser lavadas com uma solução de sabão. **Não** utilizar produtos abrasivos (como p.ex. solventes).
- Os **cintos** podem ser lavados com uma solução de sabão morna.
Cuidado! Nunca retire as linguetas do fecho **16** dos cintos.



8.2 Pulizia

Assicuratevi di utilizzare esclusivamente rivestimenti di ricambio originali Britax, poiché il rivestimento è una parte essenziale per il funzionamento del sistema. I rivestimenti di ricambio sono disponibili nei negozi specializzati.



Il seggiolino da auto non deve essere utilizzato **senza rivestimento**.

- Potete rimuovere il **revestimento** e lavarlo in lavatrice a 30 ° C con un detersivo e un programma per capi delicati. Attenetevi alle istruzioni riportate sull'etichetta di lavaggio del rivestimento. Se lavate a più di 30 ° C, è possibile che il tessuto del rivestimento si scolorisca. Non centrifugate il rivestimento e in nessun caso asciugatelo nell'asciugatrice elettrica (il tessuto può staccarsi dall'imbottitura)
- Potete lavare le **parti in plastica** con una soluzione acqua e sapone. **Non utilizzate** detersivi aggressivi (ad es. solventi).
- Potete lavare le **cinture** con una soluzione tiepida di acqua e sapone.
Attenzione! Non rimuovete mai le linguette di chiusura **16** dalle cinture.



E

Instrucciones de uso

- Las **partes acolchadas 23** se pueden desmontar y lavar con una solución jabonosa en agua templada.
¡Cuidado! Las partes acolchadas **23** reducen el riesgo de lesiones del niño en caso de accidente. Utilice el asiento infantil sólo con estas partes acolchadas **14**.

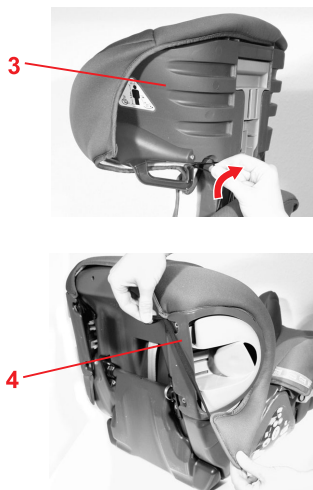

8.3 Extracción de la funda

- Retire los cinturones del modo descrito (véase 5.1).
- Desplace el reposacabezas **3** hacia arriba al máximo.
- Desenganche el borde de la funda y los bucles de goma de debajo del borde del asiento infantil.
- Extraiga la funda del reposacabezas **3**.
- Desenganche los bucles de goma de la funda de la parte inferior del asiento junto al portabebidas **4**.
- Incline la funda con el hueco sobre el reposacabezas **3**.



Manual de instruções

- As **protecções para os ombros 23** podem ser desmontadas e lavadas com uma água morna e sabão.
Cuidado! As protecções para os ombros **23** reduzem o risco de ferimentos na criança, em caso de acidente. Utilize o assento para criança unicamente com estas protecções para os ombros **14**.

8.3 Remoção do revestimento

- ✎ Retire o conjunto de cintos tal como descrito (ver 5.1).
- ✎ Desloque o apoio para a cabeça **3** totalmente para cima.
- ✎ Retire o bordo do revestimento e as corredeiras de borracha do rebordo do revestimento do assento para criança.
- ✎ Retire o revestimento do apoio para a cabeça **3**.
- ✎ Na parte inferior do assento, retire as corredeiras de borracha do revestimento no suporte para bebidas **4**.
- ✎ Vire o revestimento com o rebaixo por cima do apoio para a cabeça **3**.



Istruzioni per l'uso

- Smontate le **imbottiture spalle 23** e poi lavarle con una soluzione di sapone tiepida.
Attenzione! Le imbottiture **23** riducono il pericolo di lesioni del vostro bambino in caso di incidente. Utilizzate il seggiolino solo con queste imbottiture **14**.

8.3 Rimozione del rivestimento

- ✎ Sganciate le cinture come descritto al punto 5.1.
- ✎ Spostate il poggiatesta **3** verso l'alto.
- ✎ Sganciate il lato del rivestimento e gli occhielli elastici sotto il bordo del seggiolino.
- ✎ Rimuovete il rivestimento del poggiatesta **3**.
- ✎ Sul lato inferiore del seggiolino sganciate gli occhielli elastici del rivestimento sul portabevande **4**.
- ✎ Applicare il rivestimento con lo spazio libero sul poggiatesta **3**.



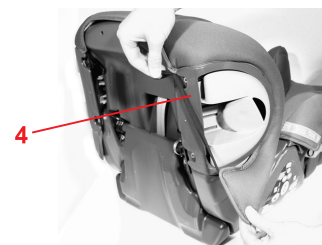
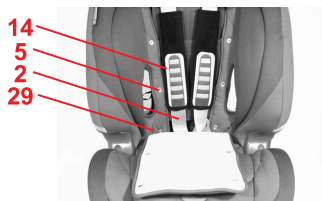

E

Instrucciones de uso

8.4 EVOLVA 1-2-3 plus: Extracción de la funda

- ✎ Afloje el cinturón de los hombros (véase 4.5).
- ✎ Despegue el cierre de velcro del acolchado ajustable **23** y extráigalo.
- ✎ Abra los botones automáticos **5** a la izquierda y a la derecha de la funda del respaldo **29** del reposacabezas **3**.
- ✎ Desenganche el borde de la funda y los bucles de goma de debajo del borde del asiento infantil.
- ✎ Extraiga la funda del reposacabezas **3**.
- ✎ Retire el broche del cinturón **15** y el cinturón regulador **17** de la funda.
- ✎ Desenganche los bucles de goma de la funda de la parte inferior del asiento junto al portabebidas **4**.
- ✎ Incline la funda con el hueco sobre el reposacabezas **3**.



8.4 EVOLVA 1-2-3 plus: Remoção do revestimento

- ✎ Solte os cintos para os ombros (ver 4.5).
- ✎ Abra o fecho de feltro na protecção da união dos cintos **23** e retire-o.
- ✎ Abra os botões de pressão **5** à esquerda e à direita no revestimento do encosto **29** e do apoio para a cabeça **3**
- ✎ Retire o bordo do revestimento e as corredeiras de borracha do rebordo do revestimento do assento para criança.
- ✎ Retire o revestimento do apoio para a cabeça **3**.
- ✎ Retire o fecho do cinto **15** e o fecho de ajuste **17** do revestimento.
- ✎ Na parte inferior do assento, retire as corredeiras de borracha do revestimento no suporte para copos **4**.
- ✎ Vire o revestimento com o rebaixo por cima do apoio para a cabeça **3**.



8.4 EVOLVA 1-2-3 plus: Rimozione del rivestimento

- ✎ Allentate le cinture spalle (vedi fig. 4.5).
- ✎ Aprite la chiusura in velcro dell'imbottitura del bacino **23** ed estraete quest'ultima.
- ✎ Aprite i pulsanti **5** a sinistra e a destra sul rivestimento dello schienale **29** e del poggiatesta **3**.
- ✎ Sganciate il lato del rivestimento e gli occhielli elastici sotto il bordo del seggiolino.
- ✎ Rimuovete il rivestimento del poggiatesta **3**.
- ✎ Sfilate la chiusura della cintura **15** e la cintura regolabile **17** dal rivestimento.
- ✎ Sul lato inferiore del seggiolino sganciate gli occhielli elastici del rivestimento sul portabicchiere **4**.
- ✎ Applicare il rivestimento con lo spazio libero sul poggiatesta **3**.



8.5 Colocación de la funda

- ↘ Repita en orden inverso la operación descrita en 8.3/8.4.
- ↘ **¡Cuidado!** Asegúrese de que no se retuerzan los cinturones y estén introducidos correctamente en las ranuras de la funda.

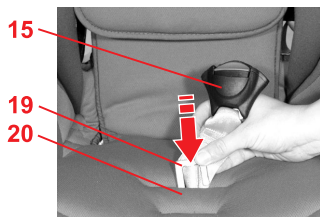

8.6 Instalación de los cinturones

- ↘ Desplace lateralmente la placa metálica 19 de arriba hacia abajo a través de la ranura del cinturón 20.
- ¡Cuidado!** Tire con fuerza del broche 15, para comprobar la sujeción.
- ↘ Introduzca los cinturones de los hombros 2 con las lengüetas de broche 16 en la funda.
- ↘ Fije el acolchado ajustable 23.
- ↘ Introduzca las lengüetas del broche 16 en el broche del cinturón (véase 5.4).
- ¡Cuidado!** No retuerza o confunda los cinturones.

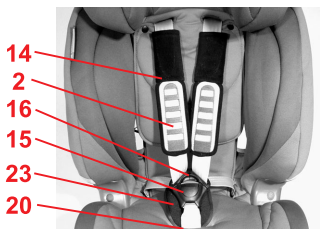



8.5 Colocação do revestimento

- ✎ Proceda simplesmente pela ordem inversa ao descrito no ponto 8.3/8.4.
- ✎ **Cuidado!** Certifique-se de que os cintos não estão torcidos e estão correctamente introduzidos nas ranhuras dos cintos do revestimento.

8.6 Montagem dos cintos

- ✎ Desloque a placa de metal **19** de canto de cima para baixo pela ranhura do cinto **20**. **Cuidado!** Puxe com força no fecho do cinto **15** para verificar a fixação.

- ✎ Introduza os cintos para os ombros **2** com as linguetas do fecho **16** no revestimento.
- ✎ Fixe a protecção da união dos cintos **23**.
- ✎ Encaixe as linguetas do fecho **16** no fecho do cinto (ver 5.4).
Cuidado! Não torcer ou trocar os cintos.

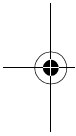

8.5 Applicazione del rivestimento

- ✎ Eseguite le istruzioni descritte al punto 8.3/8.4 in ordine inverso.
- ✎ **Attenzione!** Assicuratevi che le cinture non siano attorcigliate e che siano infilate correttamente nei passanti posti sul rivestimento.

8.6 Montaggio delle cinture

- ✎ Spingete di taglio la piastra metallica **19** dall'alto verso il basso attraverso il passante della cintura **20**.
Attenzione! Tirate energicamente la chiusura della cintura **15** per controllare il fissaggio.
- ✎ Infilate le cinture spalle **2** con le linguette di chiusura **16** nel rivestimento.
- ✎ Fissate l'imbottitura del bacino **23**.
- ✎ Fate scattare le linguette **16** nella chiusura della cintura (vedi 5.4).
Attenzione! Non attorcigliate né scambiate le cinture.

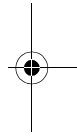

E

Instrucciones de uso

- ✧ Pase las partes acolchadas **14** por encima de los cinturones de los hombros **2**.
- ✧ Regule el regulador del reposacabezas **8** hasta la posición más alta (véase 5.2).
- ✧ Introduzca los pasadores de las partes acolchadas **14** a través de la ranura del cinturón.
- ✧ Deslice los pasadores de las partes acolchadas **14** sobre la varilla **28** del regulador de altura del cinturón **21**.
- ✧ Introduzca los cinturones de los hombros **2** a través de las ranuras del cinturón **5** y en el regulador de altura del cinturón **1**.
¡Cuidado! No retuerza o confunda los cinturones.
- ✧ Vuelva a introducir los cinturones de los hombros **2** en la pieza de unión **22**.

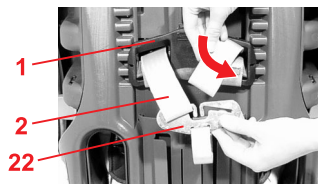
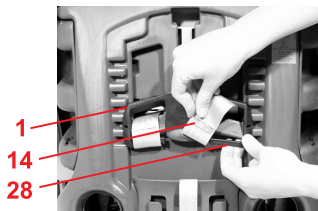



Manual de instruções

- ✎ Introduza a protecção para os ombros **14** nos cintos para os ombros **2**.
- ✎ Desloque o regulador dos apoios para a cabeça **8** para a sua posição inferior (ver 5.2).

- ✎ Introduza as correções do cinto das protecções para os ombros **14** nas ranhuras dos cintos.
- ✎ Inserir as correções do cinto da protecção para os ombros **14** na presilha **28** do dispositivo de ajuste da altura do cinto **21**.

- ✎ Introduza os cintos para os ombros **2** nas ranhuras dos cintos **5** e no dispositivo de ajuste da altura do cinto **1**.
Cuidado! Não torcer ou trocar os cintos.
- ✎ Engate o cinto que passa pelos ombros **2** de novo na peça de ligação **22**.



Istruzioni per l'uso

- ✎ Infilate l'imbottitura spalle **14** sulle cinture spalle **2**.
- ✎ Spostate il regolatore del poggiatesta **8** nella posizione inferiore (vedi 5.2).

- ✎ Infilate gli occhielli dell'imbottitura spalle **14** nei passanti della cintura.
- ✎ Spingete gli occhielli dell'imbottitura spalle **14** sull'anima **28** del regolatore in altezza delle cinture **21**.

- ✎ Infilate le cinture spalle **2** nei passanti **5** e nel regolatore in altezza delle cinture **1**.
Attenzione! Non attorcigliate né scambiate le cinture.
- ✎ Riagganciate le cinture spalle **2** nella parte di collegamento **22**.

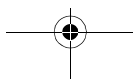
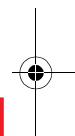



E

Instrucciones de uso

9. Instrucciones sobre la eliminación de los componentes

Consulte las disposiciones de eliminación vigentes en su país.

Eliminación del embalaje	
	Contenedor de papel y cartón
Eliminación de las piezas individuales	
Funda	Basura general, aprovechamiento térmico
Piezas de plástico	En el contenedor que corresponda en función de su identificación.
Piezas metálicas	Contenedor de metales
Broche y lengüetas	Basura general

10. 2 años de garantía

Este asiento infantil para vehículos o bicicletas tiene una garantía de 2 años por defectos de fabricación o de material. El período de garantía comienza el día de la compra del producto. Conserve la tarjeta de garantía, el control de entrega firmado por usted y el justificante de compra para acreditar la duración del período de garantía.

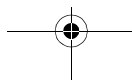
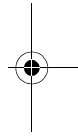
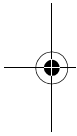



9. Indicações sobre a eliminação

Observe as determinações nacionais acerca da eliminação.

Eliminação da embalagem	
	Contentor para cartão
Eliminação de peças soltas	
Revestimento	Lixo residual, aproveitamento térmico
Peças em material sintético	conforme marcação no contentor previsto para o efeito
Peças de metal	Contentor para metais
Fecho e lingueta	Lixo residual

10. Garantia de 2 anos

Para esta cadeira de criança para bicicleta/automóvel disponibilizamos uma garantia de erros de fabrico e erros do material de 2 anos. A duração da garantia começa no dia da compra. Como comprovativo guarde o certificado de garantia preenchido, a verificação de transferência assinada por si, assim como a prova de compra durante o tempo de garantia.



9. Avvertenze per lo smaltimento

Attenetevi alle disposizioni del vostro paese relative allo smaltimento.

Smaltimento dell'imballaggio	
	Container per cartone
Smaltimento delle singole parti	
Rivestimento	Rifiuti non riciclabili, riciclaggio termico
Parti in plastica	in base al contrassegno riportato sui container previsti a tale scopo
Parti in metallo	Container per metalli
Chiusura e linguetta	Rifiuti non riciclabili

10. Garanzia di 2 anni

Per questo seggiolino da auto/bicicletta, la garanzia è di 2 anni per i difetti di fabbricazione o relativi al materiale. La garanzia decorre dal giorno dell'acquisto. Come prova, conservate, per tutta la durata del periodo di garanzia, la cartolina di garanzia compilata, la ricevuta del controllo alla consegna, da voi controfirmata, e lo scontrino d'acquisto.





E

Instrucciones de uso

En caso de reclamación, el asiento infantil deberá ir acompañado del certificado de garantía.

La garantía queda restringida a los asientos infantiles para vehículos o bicicletas que hayan sido utilizados adecuadamente y que se remitan limpios y en correcto estado.

La garantía no cubre:

- los desperfectos propios del desgaste normal ni los daños producidos al forzar el asiento
- daños debidos a un uso inapropiado

¿Qué cubre exactamente la garantía?

Tejidos: todos nuestros tejidos cumplen unos estándares estrictos en cuanto a la resistencia de los colores a las radiaciones ultravioletas. No obstante, todos los tejidos pierden color cuando se exponen a radiaciones ultravioleta. No se trata, pues, de un defecto de material, sino de fenómenos normales de desgaste que, por lo tanto, no están cubiertos por la garantía.

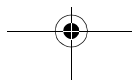
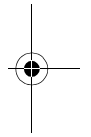
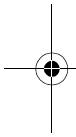



Manual de instruções

No caso de reclamação, deve anexar o certificado de garantia ao assento para criança. A garantia restringe-se a cadeira de criança para bicicleta / automóvel que foram manuseadas correctamente e são enviadas num estado limpo e correcto.

A garantia não se estende a:

- fenómenos naturais de desgaste e danos por sujeições excessivas
- danos devido a uma utilização imprópria ou incorrecta

Caso de garantia ou não?

Material: Todos os nossos materiais preenchem os mais altos requisitos relativamente a resistência da cor contra radiação UV. Porém, todos os tecidos desbotam, quando são expostos à radiação UV. Neste caso, não se trata de nenhum erro no material, mas sim de fenómenos normais de desgaste, para os quais não se assume qualquer garantia.



Istruzioni per l'uso

In caso di reclami, allegare il tagliando di garanzia al seggiolino. La garanzia è limitata ai seggiolini da auto/bicicletta, utilizzati in modo conforme e restituiti puliti ed in ordine.

La garanzia non copre:

- le normali tracce d'usura e i danni causati da una sollecitazione eccessiva,
- i danni causati da un utilizzo non idoneo e non conforme.

Caso coperto da garanzia?

Materiale: tutti i nostri materiali soddisfano elevati requisiti relativamente alla resistenza dei colori ai raggi UV. Tuttavia, tutti i tessuti sbiadiscono, se vengono esposti ai raggi UV. A tale riguardo non si tratta in alcun caso di un difetto del materiale, ma di un normale fenomeno di usura, che non è coperto da garanzia.

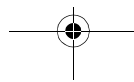
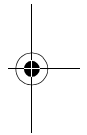



Instrucciones de uso



Broche: Los problemas de funcionamiento en el broche del cinturón se deben generalmente a la suciedad acumulada, que puede eliminarse con un buen lavado. Para ello, siga las instrucciones de uso.

En los casos propios de garantía, dirijase inmediatamente a una tienda especializada. Allí le aconsejarán y le proporcionarán la ayuda necesaria. A la hora de tramitar los derechos de reclamación, se aplican las tasas de amortización específicas del producto. A este respecto, nos remitimos a las Condiciones Generales de Contratación expuestas en el comercio del vendedor especializado.

Uso, cuidado y mantenimiento

El asiento infantil para vehículos o bicicletas debe utilizarse de acuerdo con las instrucciones de uso. Se indica de forma expresa que deben utilizarse exclusivamente accesorios y repuestos originales.

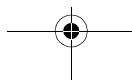



Manual de instruções

Fecho: Se ocorrerem avarias de funcionamento no fecho do cinto, estas atribuem-se muitas vezes a sujidades, que podem ser lavadas. Preste atenção ao modo de procedimento no manual de instruções.

Em caso da garantia, dirija-se de imediato ao seu revendedor especializado. Ele vai estar sempre ao seu lado para o apoiar. No processamento de reclamações são empregues taxas de amortização específicas do produto. Aqui, remetemo-nos às condições gerais de venda expostas pelo vendedor.

Utilização, conservação e manutenção

A cadeira de criança para bicicleta/automóvel tem de ser manuseada conforme o manual de instruções. Chamamos a atenção para que sejam utilizados apenas acessórios ou peças sobressalentes originais.



Istruzioni per l'uso

Chiusura: eventuali anomalie di funzionamento della chiusura della cintura vanno quasi sempre fatte risalire alla presenza di sporco, che può essere eliminato con il lavaggio. Attenetevi alla procedura indicata nelle istruzioni per l'uso.

In caso di diritto di garanzia, rivolgetevi immediatamente al vostro rivenditore specializzato, che vi assisterà con consigli e azioni concrete. Nel disbrigo dei casi in garanzia vengono applicate le detrazioni specifiche del prodotto. A tale riguardo si rimanda alle condizioni commerciali generali disponibili presso il rivenditore specializzato.

Utilizzo, manipolazione e manutenzione

Il seggiolino da auto/bicicletta deve essere trattato conformemente a quanto riportato nelle istruzioni d'uso. Si richiama espressamente l'attenzione sul fatto che possono essere utilizzati solo accessori e/o parti di ricambio originali.



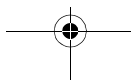
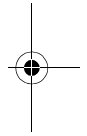
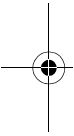



E

11. Tarjeta de garantía / Control de entrega

Nombre:

Dirección:

Código postal:

Localidad:

Teléfono (con prefijo):

Correo electrónico:

Asiento infantil para
coche o bicicleta:

Número de artículo:

Color de la funda
(diseño):

Accesorios:

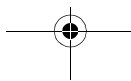



E

Control de entrega:

- 1. Completo** comprobado / correcto He examinado el asiento infantil para vehículos o bicicletas y me he asegurado de que el asiento se entrega completo y de que todos sus dispositivos funcionan correctamente.
- 2. Prueba de funcionamiento**
 - Mecanismo de regulación del asiento comprobado / correcto He recibido información suficiente sobre el producto y su funcionamiento antes de la compra y conozco las instrucciones de cuidado y mantenimiento.
 - Regulación de cinturones comprobado / correcto
- 3. Integridad**
 - Examinar el asiento comprobado / correcto
 - Examinar tejidos comprobado / correcto
 - Examinar piezas de plástico comprobado / correcto

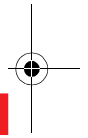
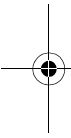

Fecha de compra: _____

Comprador (firma): _____

Vendedor: _____



Sello del vendedor

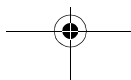



11. Certificado de garantia / verificação de transferência

Nome:

Morada:

Código Postal:

Local:

Telefone (com indicativo):

E-mail:

Cadeira de criança para
bicicleta/automóvel:

Número de artigo:

Cor do tecido (padrão):

Acessórios:

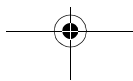
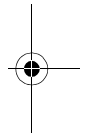
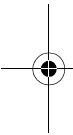

2

Verificação de transferência:

1. Totalidade

verificado / em condições

Verifiquei a cadeira de criança para bicicleta/automóvel e certifiquei-me de que o assento foi entregue completo e que todas as funções funcionam na sua totalidade.

2. Verificação da funcionalidade

- mecanismo de ajuste do assento

verificado / em condições

- Ajuste do conjunto de cintos

verificado / em condições

Obtive informações suficientes acerca do produto e das suas funções antes da compra e tomei conhecimento das instruções de conservação e manutenção.

3. Integridade

- Verificar assento

verificado / em condições

- Verificar peças do tecido

verificado / em condições

- Verificar peças em material sintético

verificado / em condições

Data de compra: _____

Comprador (assinatura): _____

Vendedor: _____

Carimbo do vendedor



11. Cartolina di garanzia/ricevuta del controllo alla consegna

Nome:

Indirizzo:

C.A.P.:

Località:

Telefono (con prefisso):

E-mail:

Seggiolino da auto/
bicycle:

Numero articolo:

Colore tessuto (design):

Accessori:

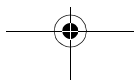
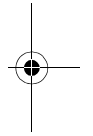
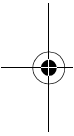

Controllo alla consegna:

1. Completezza

controllato / in ordine

Ho controllato il seggiolino da auto/bicicletta e mi sono accertato/a, che il seggiolino è stato consegnato al completo e che tutte le sue parti funzionano perfettamente.

2. Controllo funzionamento

- meccanismo di regolazione seggiolino controllato / in ordine

- Regolazione cinture controllato / in ordine

Prima dell'acquisto ho ricevuto sufficienti informazioni sul prodotto e sul suo funzionamento, e ho preso atto delle disposizioni per la sua manipolazione e manutenzione.

3. Integrità

- Controllo seggiolino controllato / in ordine

- Controllo parti in tessuto controllato / in ordine

- Controllo parti in plastica controllato / in ordine

Data d'acquisto: _____

Acquirente (firma): _____

Rivenditore: _____

Timbro rivenditore

EVOLVA 1-2-3 EVOLVA 1-2-3 plus

RUS

Инструкция по эксплуатации

Инструкция по эксплуатации

Мы счастливы, что наше сиденье EVOLVA 1-2-3 сможет стать надежным спутником Вашего ребенка на новом этапе его жизни.

Для надлежащей защиты ребенка сиденье EVOLVA 1-2-3 должно быть установлено, а затем эксплуатироваться, только в полном соответствии с настоящей инструкцией.

Если у Вас возникнут дополнительные вопросы по применению, просим обращаться в нашу фирму.

Britax Excelsior Ltd.

Содержание

1. Назначение 5
2. Применение в автомобиле 9
3. Указания 13
4. Применение детского автомобильного сиденья для детей с весом тела 9 - 18 кг 17
 - 4.1 Подгонка плечевых ремней 17
 - 4.2 Установка наклона детскогоавтомобильного сиденья 19
 - 4.3 Монтаж сиденья в автомобиле 19
 - 4.4 Проверка правильной установки детского сиденья 27
 - 4.5 Ослабьте ремни 29



DK

Brugsvejledning

Brugsvejledning

Det glæder os, at vores EVOLVA 1-2-3 kan ledsage dit barn gennem en nyt og vigtigt livsafsnit.

For at kunne beskytte barnet optimalt skal EVOLVA 1-2-3 monteres og anvendes præcist som beskrevet i denne vejledning.

Du er altid velkommen til at kontakte os, hvis du har spørgsmål.

Britax Excelsior Ltd.

Indhold

1. Egnethed	6
2. Anvendelse i køretøjet	10
3. Vigtige anvisninger	14
4. Anvendelse af autostolen til børn med 9 - 18 kg kropsvægt	18
4.1 Indstilling af skulderelemerne	18
4.2 Indstilling af auto-stolens hældning	20
4.3 Montering i bilen	20
4.4 Sådan er autostolen monteret rigtigt	28
4.5 Sådan løsnes seleterne	30

NL

Gebruiksaanwijzing

Gebruiksaanwijzing

Gefeliciteerd met de aankoop van de EVOLVA 1-2-3: de juiste keuze om uw kind veilig door een nieuwe levensfase te begeleiden.

De EVOLVA 1-2-3 moet voor een juiste bescherming van uw kind altijd worden gebruikt en gemonteerd als in deze gebruiksaanwijzing beschreven.

Als u nog vragen hebt over het gebruik, neem dan contact met ons op.

Britax Excelsior Ltd.

Inhoud

1. Geschiktheid	6
2. Gebruik in de auto	10
3. Belangrijke aanwijzingen	14
4. Gebruik van het autokinderzitje voor kinderen met een lichaamsgewicht van 9 t/m 18 kg	18
4.1 De schoudergordels afstellen	18
4.2 De hellingshoek van het auto-kinderzitje instellen	20
4.3 Inbouw in de auto	20
4.4 Zo is het autokinderzitje juist ingebouwd	28





RUS

Инструкция по эксплуатации



4.6	Пристегивание ребенка ремнями	31
4.7	Натяжение ремней	33
4.8	Проверка безопасности ребенка	37
5.	Применение детского автомобильного сиденья для детей с весом тела 15 - 36 кг	39
5.1	Демонтаж 5-точечного ремня	39
5.2	Регулировка высоты подголовника	43
5.3	Установка наклона детского автомобильного сиденья	45
5.4	Пристегивание ребенка ремнями	45
5.5	Проверка безопасности ребенка	51
6.	EVOLVA 1-2-3 plus: Регулировка ширины спинки сиденья	53
7.	Использование откидной подставки для напитков	53
8.	Инструкция по уходу	55
8.1	Уход за замком ремня	57
8.2	Очистка	61
8.3	Снятие чехла	63
8.4	EVOLVA 1-2-3 plus: Снятие чехла	65
8.5	Надевание чехла	67
8.6	Монтаж ремней	67
9.	Указания по утилизации	71
10.	Двухгодичная гарантия	71
11.	Гарантийный талон / Формуляр контроля при покупке	78

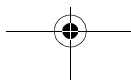
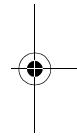
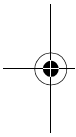

DK

Brugsvejledning

4.6	Fastspænding af barnet	32
4.7	Stramning af selerne	34
4.8	Sådan sikres barnet korrekt	38
5.	Anvendelse af auto-stolen til børn med 15 - 36 kg kropsvægt	40
5.1	Afmontering af 5-punkt-selen	40
5.2	Højdejustering af hovedstøtten	44
5.3	Indstilling af autostolens hældning	46
5.4	Fastspænding af barnet	46
5.5	Sådan sikres barnet korrekt	52
6.	EVOLVA 1-2-3 plus: Bredde-indstilling af ryglænet	54
7.	Brug af drikkeholdere, der kan drejes ud	54
8.	Anvisninger til vedligeholdelse	56
8.1	Pleje af selelåsen	58
8.2	Rengøring	62
8.3	Aftagning af betrækket	64
8.4	EVOLVA 1-2-3 plus: Aftagning af betrækket	66
8.5	Påsætning af betrækket	68
8.6	Montering af selerne	68
9.	Affaldsdeponering	72
10.	2 års garanti	72
11.	Garantibevis / udleveringskontrol	80

NL

Gebruiksaanwijzing

4.5	De gordels losser maken	30
4.6	De gordel bij uw kind omdoen	32
4.7	De gordel straktrekken	34
4.8	Zo is uw kind goed beveiligd	38
5.	Gebruik van het autokinderzitje voor kinderen met een lichaamsgewicht van 15 t/m 36 kg	40
5.1	Uitbouw van de vijfpuntsgordel	40
5.2	Instelling van de hoogte van de hoofdsteun	44
5.3	De hellingshoek van het autokinderzitje instellen	46
5.4	De gordel bij uw kind omdoen	46
5.5	Zo is uw kind goed beveiligd	52
6.	EVOLVA 1-2-3 plus: Instelling van de breedte van de rugleuning	54
7.	Gebruik van de uitklapbare bekerhouder	54
8.	Onderhoudshandleiding	56
8.1	Het gordelslot onderhouden	58
8.2	Reiniging	62
8.3	De bekleding verwijderen	64
8.4	EVOLVA 1-2-3 plus: De bekleding verwijderen	66
8.5	De bekleding bevestigen	68
8.6	Inbouw van de gordels	68
9.	Instructies voor de afvoer	72
10.	2 jaar garantie	72
11.	Garantiekaart/overdrachtscontrole	82



RUS

Инструкция по эксплуатации

1. Назначение

Детское автомобильное сиденье EVOLVA 1-2-3 разрешено для эксплуатации в возрастных группах I и II+III согласно ECE R44/04.

Для оптимальной защиты Вашего ребенка EVOLVA 1-2-3 снабжена двумя системами ремней:



Детское автомобильное сиденье Britax	Проверка и разрешение на эксплуатацию согласно ECE* R 44/04	
	Группа	Вес тела
EVOLVA 1-2-3	I	от 9 до 18 кг

*ECE = Европейский стандарт по оборудованию техники безопасности



Дети с весом тела менее 15 кг в EVOLVA 1-2-3 должны быть **зафиксированы встроенным 5-точечным ремнем** детского сиденья. Рекомендуем Вам использовать 5-точечный ремень до достижения веса тела ребенка 18 кг.



Детское сиденье EVOLVA 1-2-3 надежно закреплено в автомобиле 3-точечным ремнем.

DK

Brugsvejledning

1. Egnethed

EVOLVA 1-2-3 er godkendt som autostol for aldersgrupperne I og II+III iht. ECE R44/04.

EVOLVA 1-2-3 har to selesystemer, så barnet kan beskyttes optimalt i alle aldre:



9 - 18 kg

Britax-autostole	Afrøvet og godkendt i henhold til ECE* R 44/04	
	Gruppe	Kropsvægt
EVOLVA 1-2-3	I	9 til 18 kg

*ECE = Europæisk norm for sikkerhedsudstyr



Børn med en kropsvægt på mindre end 15 kg skal sikres med **autostolens 5-punkts-sele** i EVOLVA 1-2-3. Vi anbefaler at bruge 5-punkts-selen, til barnet har nået en kropsvægt på 18 kg.



EVOLVA 1-2-3 monteres fast i bilen med køretøjets 3-punkts-sele.

NL

Gebruiksaanwijzing

1. Geschiktheid

De EVOLVA 1-2-3 is conform ECE R44/04 goedgekeurd als autokinderzitje voor de leeftijdsgroepen I en II+III.

Om uw kind optimaal te kunnen beschermen ongeacht de leeftijd, is de EVOLVA 1-2-3 uitgerust met twee gordelsystemen:



9 - 18 kg

Britax-autokinderzitje	Controle en goedkeuring conform ECE* R 44/04	
	Groep	Lichaamsgewicht
EVOLVA 1-2-3	I	9 t/m 18 kg

*ECE = Europese norm voor veiligheidsuitrusting



Kinderen met een lichaamsgewicht van minder dan 15 kg moeten in de EVOLVA 1-2-3 worden vastgezet met de **vijfpuntsgordel van het kinderzitje**. Wij raden het gebruik van vijfpuntsgordels aan tot uw kind een lichaamsgewicht van 18 kg heeft bereikt.



De EVOLVA 1-2-3 wordt met de driepuntsgordel van de auto vast ingebouwd.



9 - 18 kg





RUS

Инструкция по эксплуатации

15 - 36 kg

Детское автомобильное сиденье Britax	Проверка и разрешение на эксплуатацию согласно ECE* R 44/04	
	Группа	Вес тела
EVOLVA 1-2-3	II+III	от 15 до 36 кг

*ECE = Европейский стандарт по оборудованию техники безопасности



Дети с весом тела более 18 кг в EVOLVA 1-2-3 должны быть **зафиксированы встроенным 3-точечным ремнем** детского сиденья.



Детское сиденье EVOLVA 1-2-3 закрепляется в автомашине непрочно. Оно просто пристегнуто вместе с ребенком 3-точечным автомобильным ремнем безопасности.

DK

Brugsvejledning

15 - 36 kg

Britax-autostol	Afprøvet og godkendt i henhold til ECE* R 44/04	
	Gruppe	Kropsvægt
EVOLVA 1-2-3	II+III	15 til 36 kg

*ECE = Europæisk norm for sikkerhedsudstyr



Børn med en kropsvægt på mere end 18 kg skal sikres med **bilens 3-punkts-sele** i EVOLVA 1-2-3.



EVOLVA 1-2-3 monteres ikke fast i bilen. Den og barnet fastgøres ganske enkelt med bilens 3-punkt-sele.

NL

Gebruiksaanwijzing

15 - 36 kg

Britax-autokinderzitje	Controle en goedkeuring conform ECE* R 44/04	
	Groep	Lichaamsgewicht
EVOLVA 1-2-3	II+III	15 t/m 36 kg

*ECE = Europese norm voor veiligheidsuitrusting



Kinderen met een lichaamsgewicht van meer dan 18 kg moeten in de EVOLVA 1-2-3 worden vastgezet met de **driepuntsgordel van de auto**.



De EVOLVA 1-2-3 wordt niet vast in de auto ingebouwd. Het zitje wordt simpelweg samen met uw kind met de driepuntsgordel van de auto vastgezet.

15 - 36 kg



RUS

Инструкция по эксплуатации

Разрешение на эксплуатацию

- Автомобильное детское сиденье сконструировано, испытано и разрешено для эксплуатации в соответствии с требованиями Европейского стандарта по оборудованию для безопасности детей в автомобиле (ECE R 44/04). Знак проверки (буква E в кружке) и номер разрешения для эксплуатации приведены на допуске к эксплуатации (наклейка на сиденье).
- При внесении пользователем каких-либо изменений в конструкцию сиденья разрешение для эксплуатации утрачивает силу. Изменения могут вноситься исключительно фирмой-изготовителем.
- Модель EVOLVA 1-2-3 должна использоваться только для закрепления Вашего ребенка в автомобиле. Она абсолютно не пригодна для использования в качестве сиденья или игрушки в домашних условиях.

2. Применение в автомобиле



Опасно! Если ребенок пристегнут в детском сиденье только 2-точечным ремнем, то при аварии он может получить тяжелые ранения или погибнуть.

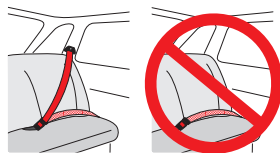



DK

Brugsvejledning

Godkendelse

- Autostolen er konstrueret, afprøvet og godkendt i henhold til kravene i den europæiske norm for børnesikkerhedsudstyr (ECE R 44/04). Kontrolmærket E (i cirklen) og godkendelsesnummeret sidder på godkendelsesetiketten (mærkat på autostolen).
- Godkendelsen bortfalder øjeblikkeligt, hvis der ændres ved autostolens konstruktion. Ændringer må kun foretages af producenten.
- EVOLVA 1-2-3 må udelukkende bruges til sikring af barnet i køretøjer. Den må ikke anvendes som stol eller legetøj derhjemme.

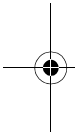

NL

Gebruiksaanwijzing

Goedkeuring

- Het autokinderzitje is ontworpen, gecontroleerd en goedgekeurd overeenkomstig de eisen in de Europese norm voor veiligheidsvoorzieningen voor kinderen (ECE R 44/04). Het keurmerk E (in een rondje) en het goedkeuringsnummer bevinden zich op het goedkeuringslabel (sticker op het autokinderzitje).
- De goedkeuring vervalt zodra er wijzigingen in het autokinderzitje worden aangebracht. Wijzigingen mogen alleen door de fabrikant worden uitgevoerd.
- De EVOLVA 1-2-3 mag uitsluitend ter bescherming van uw kind in de auto worden gebruikt. Het is niet geschikt om in huis als stoeltje of speelgoed te worden gebruikt

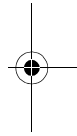

2. Anvendelse i køretøjet



Fare! Hvis barnet kun sikres med en 2-punkt-sele i autostolen, kan det kvæstes hårdt eller blive dræbt, hvis der sker en ulykke.

2. Gebruik in de auto



Gevaar! Als uw kind in het kinderzitje slechts met een tweepuntsgordel is vastgezet, kan het daardoor bij een ongeval zwaar gewond of zelfs gedood worden.

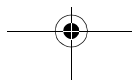

RUS

Инструкция по эксплуатации



Не применять с 2-точечным ремнем!

Варианты применения автомобильного детского сиденья:

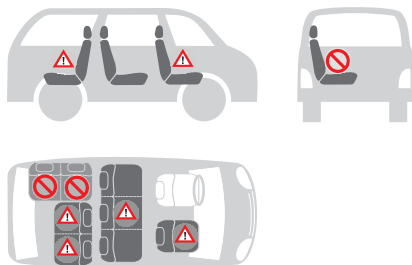

в направлении движения	да
против движения	нет 1)
с 2-точечным ремнем	нет
с 3-точечным ремнем 2)	да
на переднем сиденье	да 3)
на задних сиденьях по краям	да
на среднем заднем сиденье (с 3-точечным ремнем)	да 4)

(Соблюдайте предписания, действующие в Вашей стране)

- 1) Применение разрешается только на установленном против движения автомобильном сиденье (напр., в жилом фургоне, микроавтобусе), которое также допускается для транспортировки взрослого человека. Сиденье не должно быть оборудовано надувной подушкой безопасности.
- 2) Ремень должен иметь разрешение для эксплуатации согласно стандарту ECE R 16 (или аналогичному стандарту), свидетельством чему является, например, буква "E" ("e") в кружке на этикетке допуска на ремне.
- 3) для передней надувной подушки безопасности: Переднее пассажирское сиденье сдвинуть назад до конца, при необходимости воспользоваться указаниями руководства по эксплуатации автомобиля.
- 4) Нельзя применять, если имеется только один 2-точечный ремень.

DK

Brugsvejledning



Må aldrig bruges sammen med en 2-punkt-sele!

Autostolens anvendelsesmuligheder:

i kørselsretningen	ja
modsat kørselsretningen	nej 1)
med 2-punkt-sele	nej
med 3-punkt-sele 2)	ja
på passagersædet	ja 3)
på de yderste bagsæder	ja
På mellemste bagsæde (med 3-punkt-sele)	ja 4)

(Følg forskrifterne i dit land.)

- 1) Er kun tilladt til brug på bagudvendte bilsæder (f.eks. i varevogne, minibus), som også er godkendt til transport af voksne. Der må ikke være airbag til sædet.
- 2) Selen skal være godkendt i henhold til ECE R 16 (eller tilsvarende norm). En sådan godkendelse vil fremgå af et "E", "e" (med cirkel) på selens kontrolmærke.
- 3) Ved front-airbag: Skub passagersædet langt tilbage, og læs evt. i bilens instruktionsbog.
- 4) Kan ikke bruges, hvis der kun er en 2-punkt-sele.

NL

Gebruiksaanwijzing



Nooit in combinatie met een tweepuntsgordel gebruiken!

Het autokinderzitje kan als volgt worden gebruikt:

in de rijrichting	ja
tegen de rijrichting in	nee 1)
met tweepuntsgordel	nee
met driepuntsgordel 2)	ja
op de passagiersstoel	ja 3)
op de achterbank aan de buitenkant	ja
op de achterbank in het midden (met driepuntsgordel)	ja 4)

(Houd u aan de in uw land geldende voorschriften.)

- 1) Het gebruik is alleen toegestaan op een achterwaarts gerichte zitplaats (bijv. bus, minibus) die ook voor het vervoer van volwassenen is toegestaan. Er mag op deze zitplaats geen airbag aanwezig zijn.
- 2) De gordel dient overeenkomstig ECE R 16 (of een vergelijkbare norm) goedgekeurd te zijn. Dit is bijv. herkenbaar aan de omcirkelde "E", "e" op het controlelabel van de gordel.
- 3) Bij airbag voorin: passagiersstoel ver naar achteren schuiven, met inachtneming van de instructies in het handboek van uw auto.
- 4) Gebruik is niet mogelijk als er alleen een tweepuntsgordel aanwezig is.



RUS

Инструкция по эксплуатации

3. Указания



Для защиты Вашего ребенка

- В принципе, действует следующее правило: Чем плотнее прилегает ремень к телу ребенка, тем выше его безопасность.
- Никогда не оставляйте ребенка в установленном в автомобиле детском сиденье без присмотра.
- Применение детского сиденья на заднем сиденье автомобиля: Передвиньте переднее сиденье вперед настолько, чтобы ребенок не касался ногами спинки переднего сиденья (Опасность травмирования!).
- Металлические и пластмассовые части детского сиденья нагреваются на солнце.
Внимание! Ребенок может при этом получить ожоги. Защитите детское сиденье, если оно не используется в данный момент, от интенсивного солнечного излучения.
- Позволяйте ребенку входить и выходить только со стороны тротуара.
- Облегчите длительные поездки остановками, на которых ребенок сможет дать волю своему стремлению двигаться.

DK

Brugsvejledning

3. Vigtige anvisninger



Beskyt barnet

- Generelt gælder: Jo tættere selen sidder mod barnets krop, jo større er sikkerheden.
- Lad aldrig barnet være uden opsyn, når det sidder i autostolen i bilen.
- Anvendelse på bagsædet: Ryk forsædet så langt frem, at barnet ikke kan nå forsædets ryglæn med fødderne (fare for tilskadekomst).
- Autostolens metal- og plastdele opvarmes, når solen skinner på dem.
Forsigtig! Pas på, at barnet ikke brænder sig. Beskyt autostolen mod kraftigt sollys, når den ikke er i brug.
- Lad kun barnet stige ind og ud af bilen til fortovssiden.
- Hold regelmæssigt pauser under længere ture, så barnet har mulighed for at bevæge sig.

NL

Gebruiksaanwijzing

3. Belangrijke aanwijzingen



Ter bescherming van uw kind

- In principe geldt: Hoe beter de gordel op het lichaam van uw kind aansluit, hoe groter de veiligheid.
- Laat uw kind nooit zonder toezicht in het kinderzitje in de auto achter.
- Gebruik op de achterbank: Schuif de voorstoel zo ver naar voren dat de voeten van uw kind de rugleuning van de voorstoel niet raken (verwondingsgevaar).
- De metaal- en kunststofdelen van het kinderzitje worden heet in de zon.
Voorzichtig! Uw kind kan zich hieraan verbranden. Bescherm het kinderzitje, wanneer dit tijdelijk niet wordt gebruikt, tegen intensieve zonnestraling.
- Laat uw kind alleen in- en uitstappen aan de zijde van het trottoir.
- Houd tijdens lange ritten regelmatig pauzes zodat u tegemoetkomt aan de bewegingsdrang van uw kind.



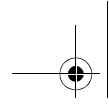

RUS

Инструкция по эксплуатации



Для защиты всех пассажиров

При экстренном торможении или дорожно-транспортном происшествии незакрепленные предметы и не пристегнутые пассажиры могут причинить травмы другим пассажирам. Поэтому необходимо всегда следить за тем, чтобы...

- были закреплены спинки сидений (например, зафиксировать заднее откидное сиденье).
- были зафиксированы все находящиеся в автомобиле тяжелые предметы или предметы с острыми краями (например, на полке заднего стекла),
- все пассажиры были пристегнуты ремнями,
- детское сиденье всегда было зафиксировано, даже если в нем не перевозится ребенок.

Для защиты Вашего автомобиля

- При использовании детского сиденья на автомобильных чехлах из восприимчивых к деформациям материалов (например, из велюра, кожи и т.п.) могут появиться потертые места.

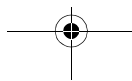
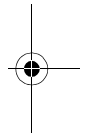
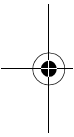

DK

Brugsvejledning



Passagersikkerhed

Hårde opbremsninger eller biluheld indebærer altid en risiko for tilskadekomst som følge af f.eks. genstande eller personer, som ikke er sikret forsvarligt. Kontrollér derfor altid, at:

- bilsædernes ryglæn er fastgjort (gælder også for bagsædet).
- tunge eller skarpkantede genstande i bilen (f.eks. på baghylden) er sikret forsvarligt.
- alle personer i bilen benytter sikkerhedssele.
- autostolen er spændt fast, også selvom barnet ikke sidder i den.

Beskyttelse af bilen

- På sædebetræk af f.eks. velour, læder etc. kan autostolen efterlade mærker.

NL

Gebruiksaanwijzing



Ter bescherming van alle passagiers

Bij een noodstop of een ongeval kunnen niet vastgezette voorwerpen of personen andere passagiers verwonden. Zorg er daarom altijd voor dat...

- de rugleuningen van de zitplaatsen zijn vastgezet (bijv. de neerklapbare rugleuning van de achterbank vastklikken);
- alle zware of scherpe voorwerpen in de auto (bijv. op de hoedenplank) zijn vastgezet;
- alle personen in de auto de gordel om hebben;
- het kinderzitje in de auto is vastgezet, ook als er geen kind word vervoerd.

Ter bescherming van uw auto

- Bepaalde autostoelbekledingen van gevoelig materiaal (bijv. velours, leer, etc) kunnen tekenen van slijtage gaan vertonen door gebruik van het autokinderzitje.



RUS

Инструкция по эксплуатации

4. Применение детского автомобильного сиденья для детей с весом тела 9 - 18 кг

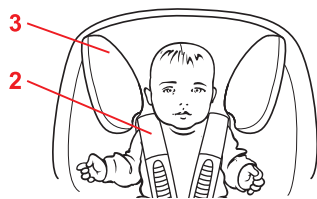

4.1 Подгонка плечевых ремней

Правильно подогнанные плечевые ремни обеспечивают ребенку оптимальную посадку в детском сиденье.



Плечевые ремни 2 должны проходить на высоте плеч ребенка или выше.

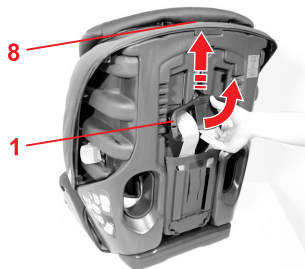

Вы можете подогнать высоту плечевых ремней к росту ребенка следующим образом:

- ✧ Ослабьте ремни насколько это возможно (см. 4.5).
- ✧ Отклонив регулятор высоты ремня 1, освободите его из фиксатора.
- ✧ Сместите регулятор высоты ремня на нужную высоту плечевого ремня и зафиксируйте его снова.

Внимание! Регулятор подголовника должен находиться в 8 своей нижней позиции.

DK

Brugsvejledning

4. Anvendelse af autostolen til børn med 9 - 18 kg kropsvægt



4.1 Indstilling af skulderselerne



Korrekt indstillede skulderseler giver barnet den optimale støtte i autostolen.

Skulderselerne **2** skal sidde i barnets skulderhøjde eller lidt over.

Skulderselernes højde indstilles efter barnets størrelse på følgende måde:

- ✎ Løsn selerne så meget som muligt (se 4.5).
 - ✎ Tag selehøjde-indstillingen **1** ud af låsemekanismen.
 - ✎ Flyt selehøjde-indstillingen **1** til den rigtige skulderhøjde, og sæt den i hak.
- Forsigtig!** Sørg for, at hovedstøtte-indstillingen **8** er i den nederste position.

NL

Gebruiksaanwijzing

4. Gebruik van het autokinderzitje voor kinderen met een lichaamsgewicht van 9 t/m 18 kg



4.1 De schoudergordels afstellen



Juist afgestelde schoudergordels zorgen voor een optimale ondersteuning van uw kind in het autokinderzitje.

De schoudergordels **2** moeten op schouderhoogte van het kind of iets daarboven lopen.

U kunt de hoogte van de schoudergordels als volgt op de lichaamsgrootte van uw kind afstellen:

- ✎ Maak de gordels zover mogelijk los (zie 4.5).
 - ✎ Klik de gordelhoogteverstelling **1** uit de vergrendeling.
 - ✎ Schuif de gordelhoogteverstelling op de juiste hoogte voor de schoudergordels en klik deze vast.
- Let op!** Let erop dat de hoofdsteunverstelling zich **8** in de onderste stand bevindt.



RUS

Инструкция по эксплуатации

4.2 Установка наклона детского автомобильного сиденья



До установки в Вашем автомобиле Вы можете установить сиденье в 2х положениях:

Полезный совет! Если ремень безопасности Вашего автомобиля слишком короткий, Вы можете установить детское сиденье в вертикальном положении.

✧ Для этого наклоните распорный клин **21** вперед или назад в желаемое положение.

- **назад:** для вертикального положения
- **вперед:** для комфортного сидения

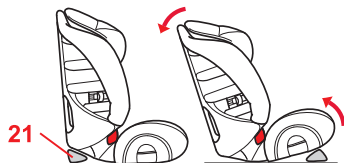

4.3 Монтаж сиденья в автомобиле



Вы можете зафиксировать детское сиденье с помощью 3-точечного ремня, действуя следующим образом:

- ✧ Установите детское сиденье в направлении движения на автомобильном сиденье.
- ✧ Расположите диагональный ремень **6** между подголовником и боковиной **18** спинки сиденья.

Внимание! Не допускать скручивания ремня.

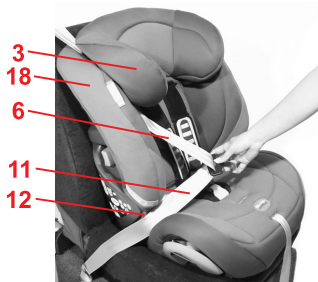

DK

Brugsvejledning

4.2 Indstilling af auto-stolens hældning



Sådan kan du indstille autostolen i to hældninger før montering i bilen:

Tip! Hvis bilselen er for kort under indbygning i bilen, kan det hjælpe at stille autostolen i oprejst stilling.

- ↘ Drej afstandskilen **21** frem eller tilbage til den ønskede stilling.
- **tilbage:** barnet sidder oprejst
- **frem:** barnet lænes behageligt tilbage

4.3 Montering i bilen

Sådan sikrer du autostolen med køretøjets 3-punkt-sele:

- ↘ Stil autostolen på bilsædet i kørselsretningen.
- ↘ Læg diagonalselen **6** mellem hovedstøtten og ryglænets sidedel **18**,
Forsigtig! Pas på, at selen ikke snor sig.

NL

Gebruiksaanwijzing

4.2 De hellingshoek van het auto-kinderzitje instellen



U kunt het kinderzitje voor inbouw in de auto als volgt op twee hellingshoeken instellen:

Tip! Als de autogordel bij de inbouw te kort blijkt te zijn, kan het helpen het kinderzitje recht overeind te houden.

- ↘ Draai daarvoor het afstandsblokje **21** naar de gewenste plaats aan de voorzijde- of achterzijde.
- **achter:** voor rechtop zitten
- **voor:** voor comfortabel achterover leunen

4.3 Inbouw in de auto

U kunt het kinderzitje met de driepuntsgordel van de auto als volgt vastzetten:

- ↘ Plaats het kinderzitje in de rijrichting op de autostoel.
- ↘ Leid het schoudergedeelte **6** van de gordel tussen de hoofdsteen en het zijstuk **18** van de rugleuning.
Let op! Verdraai de gordel niet.

9 - 18 kg

RUS

DK

NL

20

RUS

Инструкция по эксплуатации



- ✘ Вставьте поясной ремень **11** в обе светлокрасные направляющие ремня **12**.
Внимание! Не допускать перекручивания ремня.
- ✘ Соедините 80 см диагонального ремня **6** и поясного ремня **11**.
Внимание! Не допускать скручивания ремня.

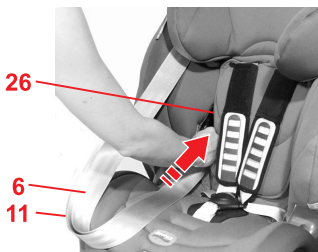

- ✘ Протяните ремень через первый ввод ремня **26** спинки сиденья.



DK

Brugsvejledning

- ✂ Læg hofseselen **11** ind i de to lyserøde seleføringer **12**.
Forsigtig! Pas på, at selen ikke snor sig.
- ✂ Saml cirka 80 cm af diagonalselen **6** og hofseselen **11**.
Forsigtig! Pas på, at selen ikke snor sig.

NL

Gebruiksaanwijzing

- ✂ Leid het heupgedeelte **11** van de autogordel in de twee lichtrode gordelgeleiders **12**.
Let op! Verdraai de gordel niet.
- ✂ Pak ongeveer 80 cm van het schoudergedeelte **6** en het heupgedeelte **11** van de autogordel samen vast.
Let op! Verdraai de gordel niet.

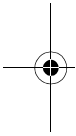

- ✂ Træk bilselen forfra gennem ryglænets første seleåbning **26**.

- ✂ Leid de autogordel van voren door de eerste gordeldoorvoer **26** van de rugleuning.

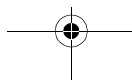
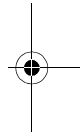

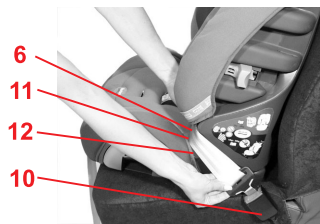
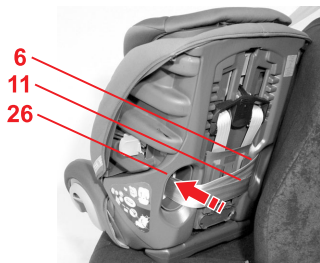

RUS

Инструкция по эксплуатации

- ✧ Немного разверните детское сиденье от автомобильного.
- ✧ Выведите ремень через второй ввод ремня **26** вперед.
Внимание! Не допускать скручивания ремня.

- ✧ Вставьте диагональный ремень **6** и поясной ремень **11** со стороны замка ремня автомобиля **10** во входы ремня **12**.
- ✧ Зафиксируйте язычки в замке автомобильного ремня **10**. ЩЕЛК!

Встаньте коленями на детское сиденье и натяните ремень безопасности след. образом:

- ✧ Потяните диагональный ремень **6**, затем ремень безопасности, чтобы натянуть поясной ремень **11**.



DK

Brugsvejledning

- ✎ Drej autostolen lidt væk fra bilsædet.
- ✎ Træk bilselen bagfra gennem den anden seleåbning **26** og frem igen.
Forsigtig! Pas på, at selen ikke snor sig.

NL

Gebruiksaanwijzing

- ✎ Draai het kinderzitje iets van de autostoel af.
- ✎ Leid nu de autogordel van achteren door de tweede gordeldoos **26** van de rugleuning.
Let op! Verdraai de gordel niet.



9 - 18 kg

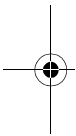

- ✎ Læg diagonalselen **6** og hofseselen **11** ind i seleføringerne **12** på den side, hvor bilens selelås **10** sidder.
- ✎ Lad låsetungen gå i hak i bilens selelås **10**. KLIK!

- ✎ Leid het schoudergedeelte **6** en het heupgedeelte **11** van de autogordel aan de kant van gordelslot **10** door de gordelgeleider **12**.
- ✎ Klik de gespdelen in het gordelslot **10** vast. KLIK!



Sæt knæet op i autostolen, og stram bilselen på følgende måde:

- ✎ Træk først i diagonalselen **6** fornedet ved bilens selelås for at stramme hofseselen **11**.

Plaats uw knie in het kinderzitje en trek de autogordel als volgt strak:

- ✎ Trek eerst aan het schoudergedeelte **6** van de autogordel onder aan het gordelslot om het heupgedeelte **11** aan te trekken.

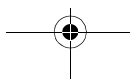

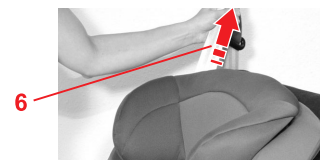

RUS

Инструкция по эксплуатации

Удерживайте диагональный ремень **6** снизу и протяните над вводом ремня **26** диагональный ремень **6** вперед, чтобы протянуть свободный ремень.

Потяните за диагональный ремень **6**, чтобы натянуть весь автомобильный ремень. **Внимание!** Замок автомобильного ремня **10** ни в коем случае не должен находиться в направляющей ремня **12**. В противном случае попытайтесь поменять сиденья или установите детское сиденье в наклонное положение (см. 4.2)

Убедитесь, что детское сиденье надежно закреплено. В противном случае повторно затяните ремень. **Полезный совет!** Наклоните зафиксированное сиденье вперед. Оно должно быть закреплено неподвижно.



DK

Brugsvejledning

- ✘ Hold fast i diagonalselen **6** forenden, og træk så diagonalselen **6** frem over seleåbningen **26** for at trække den løse sele igennem.

NL

Gebruiksaanwijzing

- ✘ Houd het schoudergedeelte **6** van de autogordel onderaan vast en trek dan boven aan de gordeldoorvoer **26** het schoudergedeelte **6** naar voren om de losse gordel door te trekken.



9 - 18 kg

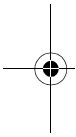

- ✘ Træk nu kraftigt i diagonalselen **6** for at stramme hele bilselen.

Forsigtig! Bilens selelås **10** må under ingen omstændigheder ligge i seleføringsen **12**. Hvis det er tilfældet, skal du prøve på et andet sæde eller montere barnesædet i den tilbagelænedede stilling (se 4.2).

- ✘ Trek nu stevig boven aan het schoudergedeelte **6**, van de autogordel om de hele autogordel aan te trekken.

Let op! Het gordelslot **10** mag in geen geval in de gordelgeleider **12** liggen. Indien dit wel het geval is, probeert u het kinderzitje op een andere zitplaats in de achteroverleunstand (zie 4.2) in te bouwen.

- ✘ Kontrollér, at autostolen er monteret, så den sidder fast. Stram ellers bilselen endnu mere.
Tip! Træk autostolen frem i selen. Den må ikke kunne bevæge sig eller kun en lille smule.

- ✘ Zorg ervoor dat het kinderzitje vast is ingebouwd. Trek anders de autogordel nogmaals strak.
Tip! Trek het kinderzitje aan de gordel naar voren. Er mag niet of nauwelijks beweging zijn.



26

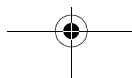

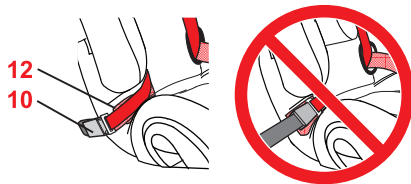
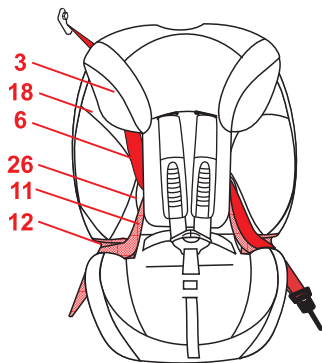

RUS

Инструкция по эксплуатации

4.4 Проверка правильной установки детского сиденья



Для гарантии безопасности Вашего ребенка убедитесь в том, что...

- детское сиденье надежно закреплено в автомобиле,
- автомобильный ремень натянут и не скручен,
- поясной ремень **11** проходит через обе ярко-красные направляющие ремня **12**,
- диагональный ремень **6** на автомобильном ремне **10** на противоположной стороне, проходит между боковиной **18** и подголовником **3**,
- язычки замка и замок автомобильного ремня **10** не находятся в красных направляющих ремня **12** автомобильного детского сиденья,

DK

Brugsvejledning

4.4 Sådan er autostolen monteret rigtigt



Kontrollér for en sikkerheds skyld følgende...

- autostolen er fast monteret i bilen,
- bilens sele er stram og ikke snoet,
- hofteselen **11** går gennem begge de lyserøde seleføringer **12**,
- diagonalselen **6** sidder på siden over for bilens seletås **10**, mellem sidedelen **18** og hovedstøtten **3**,
- låsetungen og seletåsen **10** til bilens sele sidder **ikke** i autostolens lyserøde seleføringer **12**,

NL

Gebruiksaanwijzing

4.4 Zo is het autokinderzitje juist ingebouwd



Controleer voor de veiligheid van uw kind of...

- het autokinderzitje vast in de auto is ingebouwd,
- de autogordel strak is gespannen en niet is verdraaid,
- het heupgedeelte **11** van de gordel door de twee lichtrode gordelgeleiders **12** loopt,
- het schoudergedeelte **6** van de autogordel aan de tegenover het gordelslot **10** liggende zijde tussen het zijstuk **18** en de hoofdsteun **3** loopt,
- de gespdelen en het slot **10** van de autogordel **niet** in de lichtrode gordelgeleiders **12** van het autokinderzitje liggen,



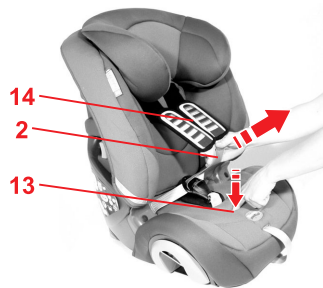
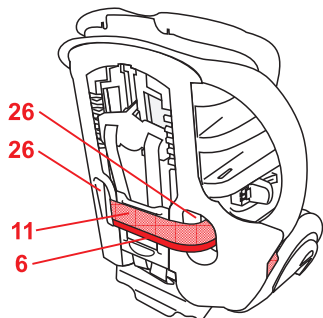

RUS

Инструкция по эксплуатации

- поясной ремень **11** и диагональный ремень **6** проходят через направляющие ремня **26** спинки сиденья.

4.5 Ослабьте ремни

- ✎ Нажмите на кнопку регулировки натяжения **13** и вытяните оба плечевых ремня **2** одновременно вперед. **Внимание!** Не допускается тянуть за плечевые подкладки **14**.





DK

Brugsvejledning

- hofseselen **11** og diagonalselen **6** går gennem ryglænets seleføringer **26**.

NL

Gebruiksaanwijzing

- het heupgedeelte **11** en het schoudergedeelte **6** van de autogordel door de gordeldoorvoeren **26** van de rugleuning lopen.



9 - 18 kg

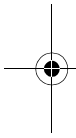

4.5 Sådan løsnes selerne

- ✎ Tryk på justeringsknappen **13**, og træk de to skulderseler **2** frem samtidig.

Forsigtig! Træk ikke i skulderpolstringerne **14**.



4.5 De gordels losser maken

- ✎ Druk op de verstelknop **13** en trek de beide schoudergordels **2** tegelijkertijd naar voren.

Let op! Trek niet aan de schouderkussentjes **14**.

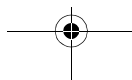
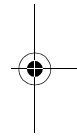

RUS

Инструкция по эксплуатации

4.6 Пристегивание ребенка ремнями

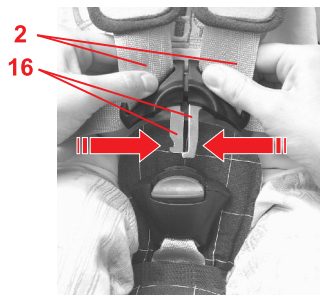
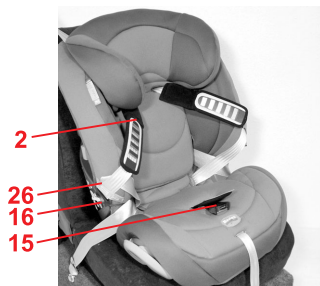

- ✧ Ослабьте плечевые ремни **2** (см. пункт 4.5).
- ✧ Откройте замок ремня **15** (нажав на красную кнопку).
- ✧ Введите язычки замка **16** в резиновые крепления **26**.
- ✧ Усадите ребенка в детское сиденье.
- ✧ Направьте плечевые ремни **2** поверх плеч ребенка.
Внимание! Не допускать скручивания или перестановки плечевых ремней **2**.
- ✧ Сведите оба язычка замка **16** друг с другом...

DK

Brugsvejledning

4.6 Fastspænding af barnet



- ✘ Løsn skulderselerne **2** (se 4.5).
- ✘ Åbn selelåsen **15** (tryk på den røde knap).
- ✘ Sæt låsetungerne **16** ind i holdegummiet **26**.
- ✘ Sæt barnet i autostolen.
- ✘ Læg skulderselerne **2** over barnets skuldre.
Forsigtig! Skulderselerne **2** må ikke snos, og der må ikke byttes om på dem.

- ✘ Sæt de to låsetunger **16** sammen...

NL

Gebruiksaanwijzing

4.6 De gordel bij uw kind omdoen



- ✘ Maak de schoudergordels **2** wat losser. (zie 4.5).
- ✘ Open het gordelslot **15** (druk op de rode knop).
- ✘ Steek de gespdelen **16** in de bevestigingsrubbers **26**.
- ✘ Plaats uw kind in het kinderzitje.
- ✘ Leid de schoudergordels **2** over de schouders van uw kind.
Let op! Verdraai de schoudergordels **2** niet en wissel deze ook niet om.

- ✘ Breng de beide gespdelen **16** bij elkaar...



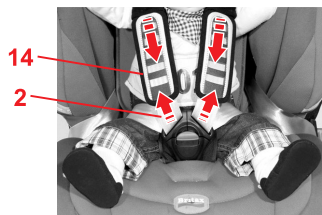
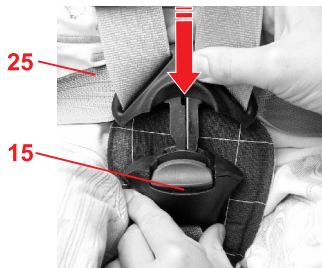

RUS

Инструкция по эксплуатации

- ✧ ... и зафиксируйте их с щелчком в замке ремня **15**. ЩЕЛК!
- ✧ Натяните ремни так, чтобы они плотно прилегали к телу ребенка (см. 4.7).
Внимание! Поясные ремни **25** должны проходить через паховый сгиб ребенка как можно ниже.

4.7 Натяжение ремней

- ✧ Потяните регулировочный ремень **17**, система ремней должна равномерно и плотно прилегать к телу ребенка.
Внимание! Ziehen Sie den Verstellgurt **17** вытяните конец ремня прямо не смещая его в сторону или вверх.
- ✧ Разровняйте плечевые накладки **14** снова по направлению вниз.
- ✧ Потяните плечевые ремни **2**, убедитесь, что плечевые ремни **25** натянуты и ремень прилегает равномерно.
- ✧ Потяните регулировочный ремень **17**, система ремней должна равномерно и плотно прилегать к телу ребенка.



DK

Brugsvejledning

- ✎ ...og lad dem gå i hak i seletåsen **15** (skal kunne høres). KLIK!
- ✎ Stram selerne, så de ligger tæt ind til barnets krop (se 4.7).
Forsigtig! Hofteselerne **25** skal sidde så tæt på barnets lysken som muligt.

NL

Gebruiksaanwijzing

- ✎ ...en klik deze hoorbaar in het gordelslot **15** vast. KLIK!
- ✎ Trek de gordels aan tot deze strak om het lichaam van uw kind zitten (zie 4.7).
Voorzichtig! De heupgordels **25** moeten zo laag mogelijk over de liezen van uw kind lopen.



4.7 Stramning af selerne

- ✎ Træk i indstillingssele **17**, til sele sidder tæt og ensartet på barnets krop.
Forsigtig! Træk indstillingssele **17** så lige ud som muligt og ikke til siden eller op.

4.7 De gordel straktrekken

- ✎ Trek aan de verstelgordel **17** tot de gordels gelijkmatig en strak om het lichaam van uw kind zitten.
Let op! Trek de verstelgordel **17** indien mogelijk recht naar buiten en niet zijdelings of naar boven.

- ✎ Træk skulderpolstringerne **14** ned igen.
- ✎ Træk i skulderselerne **2** for at kontrollere, at hofteselerne **25** er stramme, og at sele sidder stramt til.
- ✎ Træk i indstillingssele **17** igen, til sele sidder tæt og ensartet på barnets krop.

- ✎ Trek de schouderkussentjes **14** weer naar beneden.
- ✎ Trek aan de schoudergordels **2** om ervoor te zorgen dat de heupgordels **25** zijn aangetrokken en de gordels gelijkmatig aansluiten.
- ✎ Trek nogmaals aan de verstelgordel **17** tot de gordels gelijkmatig en strak om het lichaam van uw kind zitten.

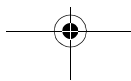
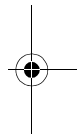

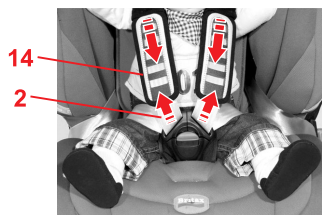
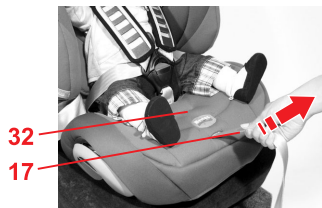

RUS

Инструкция по эксплуатации

EVOLVA 1-2-3 plus: Затяните ремни, используя Click & Safe™



☞ Тяните за регулировочный ремень **17**, пока индикация натяжения ремня **32** не издаст щелчок.

Полезный совет! Ziehen Sie den Verstellgurt **17** вытяните конец ремня прямо не смещая его в сторону или вверх.

- ☞ Разровняйте плечевые накладки **14** снова по направлению вниз.
- ☞ Потяните плечевые ремни **2**, убедитесь, что плечевые ремни **25** натянуты и ремень прилегает равномерно.
- ☞ Еще раз до щелчка потяните за конец ремня **17**, пока не услышите щелчок.



DK

Brugsvejledning

EVOLVA 1-2-3 plus: **Stramning af selerne med Click & Safe™**



Click & Safe

- Træk i indstillingsselen **17**, indtil der kan høres et tydeligt klik på selens spændingsindikator **32**.
- Tip!** Træk indstillingsselen **17** så lige ud som muligt og ikke til siden eller op.

NL

Gebruiksaanwijzing

EVOLVA 1-2-3 plus: **De gordels straktrekken met Click & Safe™**



Click & Safe

- Trek aan de verstelgordel **17** tot u de gordelspanningsindicatie **32** duidelijk hoort klikken.
- Tip!** Trek de verstelgordel **17** indien mogelijk recht naar buiten en niet zijdelings of naar boven.

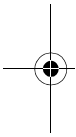

- Træk skulderpolstringerne **14** ned igen.
- Træk i skulderselerne **2** for at kontrollere, at hofeselerne **25** er stramme, og at selen sidder stramt til.
- Træk i indstillingsselen **17** igen, indtil der kan høres et klik.

- Trek de skouderkussentjes **14** weer naar beneden.
- Trek aan de schoudergordels **2** om ervoor te zorgen dat de heupgordels **25** zijn aangetrokken en de gordels gelijkmatig aansluiten.
- Trek nogmaals aan de verstelgordel **17** tot u een klik hoort.

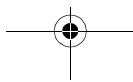
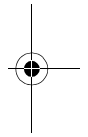

RUS

Инструкция по эксплуатации

4.8 Проверка безопасности ребенка



Для гарантии безопасности Вашего ребенка убедитесь в том, что...

- ремни детского сиденья плотно прилегают к телу ребенка, не стесняя его,
- плечевые ремни **2** правильно отрегулированы,
- ремни **не** перекручены,
- язычки замка **16** зафиксированы в замке ремня **15**,
- плечевые подкладки **14** правильно прилегают к телу.

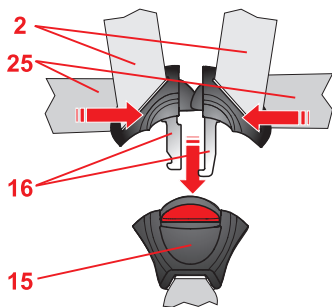

DK

Brugsvejledning

4.8 Sådan sikres barnet korrekt



Kontrollér for en sikkerheds skyld følgende...

- autostolens seler skal sidde tæt ind til barnets krop uden at sidde for stramt,
- skulderselerne **2** skal være korrekt indstillet,
- selerne må **ikke** være snoede,
- låsetungerne **16** skal være i hak i selelåsen **15**,
- skulderpolstringerne **14** skal sidde tæt til kroppen.

NL

Gebruiksaanwijzing

4.8 Zo is uw kind goed beveiligd



Controleer voor de veiligheid van uw kind of...

- de gordels van het autokinderzitje nauwsluitend zitten zonder uw kind echter te beknellen,
- de schoudergordels **2** juist zijn afgesteld,
- de gordels **niet** zijn verdraaid,
- de gespdelen **16** in het gordelslot **15** zijn vastgeklikt,
- de schouderkussentjes **14** vast tegen het lichaam aanliggen.



RUS

Инструкция по эксплуатации

5. Применение детского автомобильного сиденья для детей с весом тела 15 - 36 кг

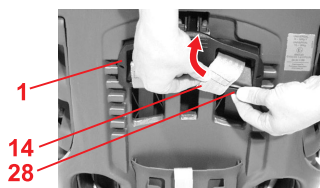
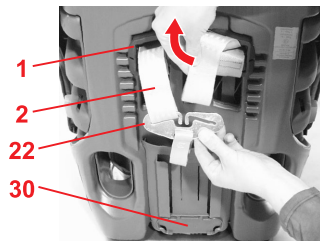

5.1 Демонтаж 5-точечного ремня

- ✧ Ослабьте ремни насколько это возможно (см. 4.5).
- ✧ Поверните вверх дугу для ношения **1** детского сиденья (см. 4.1).
- ✧ Вытяните плечевые ремни **2** из соединительного элемента **22**.
- ✧ Защелкните соединительный элемент **22**, на спинке сиденья снизу **29**, в крепление **30**.
- ✧ Петли ремня плечевых подкладок **14** переместите с перемычки **28** регулятора высоты ремня **1** вниз.
- ✧ Вытяните плечевые ремни **2** и петли ремня плечевых подкладок **14** из пазов для ремня.
- ✧ Откройте текстильную застежку на перемещаемой подкладке **23** и снимите ее.

DK

Brugsvejledning

5. Anvendelse af auto-stolen til børn med 15 - 36 kg kropsvægt



5.1 Afmontering af 5-punkt-selen

- ✎ Løsn selerne så meget som muligt (se 4.5).
- ✎ Stil selehøjde-indstillingen **1** helt op (se 4.1).
- ✎ Tag skulderselerne **2** ud af forbindelsesdelen **22**.
- ✎ Klips forbindelsesdelen **22** nederst på ryglænet **29** i holderen **30**.
- ✎ Skub skulderpolstringernes selestropper **14** ned fra selehøjde-indstillingens **1** mellemstykke **28**.
- ✎ Tag skulderselerne **2** og skulderpolstringernes selestropper **14** ud af seleslidserne.
- ✎ Åbn velcrobåndet ved skridtpolstringen **23** og tag den af.

NL

Gebruiksaanwijzing

5. Gebruik van het autokinderzitje voor kinderen met een lichaamsgewicht van 15 t/m 36 kg



5.1 Uitbouw van de vijfpuntsgordel

- ✎ Maak de gordels zover mogelijk los (zie 4.5).
- ✎ Schuif de gordelhoogteverstelling **1** helemaal naar boven (zie 4.1).
- ✎ Maak de schoudergordels **2** los van het verbindingsstuk **22**.
- ✎ Klik het verbindingsstuk **22**, onder aan de rugleuning **29** in de bevestiging **30**.
- ✎ Schuif de gordellussen van de schouderkussentjes **14** van de overbrugging **28** van de gordelhoogteverstelling **1** omlaag.
- ✎ Trek de schoudergordels **2** en de gordellussen van de schouderkussentjes **14** uit de gordelsleuven.
- ✎ Open de klittenbandsluiting van de gordelslothes **23** en verwijder deze.



15 - 36 kg



40

RUS

Инструкция по эксплуатации

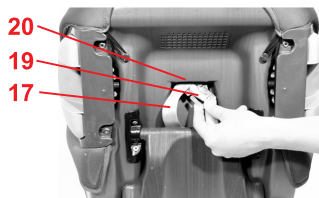

- ✘ Снимите регулировочный ремень **17** из металлической пластины **19**.
- ✘ Проденьте металлическую пластинку **19**, при помощи которой замок ремня **15** закреплен на сиденье, ребром через паз для ремня **20**.
- ✘ Откройте замок ремня **15** снова.

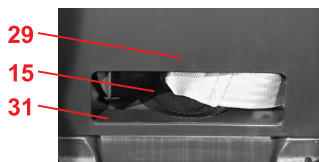

- ✘ Протяните ремни с язычками **16** через пазы для поясного ремня чехла.
- ✘ Поместите замок ремня **15** в вещевой ящик под чехлом **31** в спинке сиденья **29**.

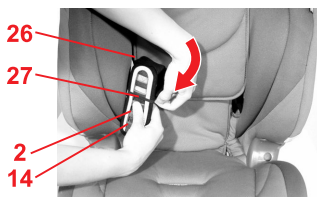

- ✘ Поместите регулировочный ремень **17** под чехол.
- ✘ Закрепите плечевые накладки **14** и плечевые ремни **2** в резиновых петлях **27** на направляющих ремня **26**.



DK

Brugsvejledning

- ✂ Tag indstillingsselen **17** ud af metalpladen **19**.
- ✂ Skub metalpladen **19**, som forbinder selelåsen **15** med autostolen, på højkant gennem seleslidsen **20**.
- ✂ Åbn selelåsen **15** igen.

- ✂ Træk selerne med låsetungerne **16** gennem betrækkets hofeseleslids.
- ✂ Læg selelåsen **15** ind under betrækket i opbevaringsrummet **31** i ryglænet **29**.

- ✂ Skub indstillingsselen **17** ind under betrækket.
- ✂ Fastgør skulderpolstringerne **14** og skulderselerne **2** i gummistropperne **27** på selegennemføringerne **26**.

NL

Gebruiksaanwijzing

- ✂ Maak de verstelgordel **17** los van de metalen plaat **19**.
- ✂ Schuif de metalen plaat **19** waarmee het gordelslot **15** aan de zitkuip is bevestigd met de smalle kant door de gordelsleuf **20**.
- ✂ Open het gordelslot **15**.

- ✂ Schuif de gordels met de gespden **16** door de sleuven voor het heupgedeelte van de autogordel in de bekleding.
- ✂ Leid het gordelslot **15** onder de bekleding door naar het opbergvak **31** in de rugleuning **29**.

- ✂ Schuif de verstelgordel **17** onder de bekleding.
- ✂ Bevestig de schouderkussentjes **14** en de schoudergordels **2** in de rubberen lussen **27** aan de gordeldoorvoeren **26**.

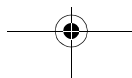
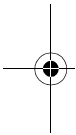
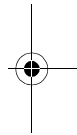

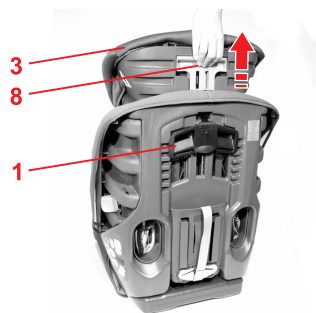
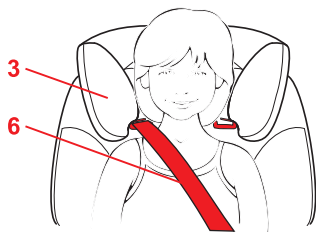

RUS

Инструкция по эксплуатации

5.2 Регулировка высоты подголовника



Правильно подогнанный подголовник **3** обеспечивает оптимальное положение диагонального ремня **6**, и гарантирует ребенку необходимую защиту и комфорт. Подголовник **3** можно зафиксировать по высоте в одном из 5 положений.

- Подголовник **3** должен быть отрегулирован таким образом, чтобы между плечами ребенка и подголовником **3** могли поместиться два пальца.

Отрегулировать высоту подголовника 3 в соответствии с ростом ребенка можно следующим образом:

- ☞ Поверните вверх дугу для ношения **1** детского сиденья (см. 4.1).
- ☞ Усадите ребенка в детское сиденье.
- ☞ Возьмитесь за заднюю сторону подголовника **3** и потяните регулятор подголовника **8** вверх. Теперь подголовник **3** разблокирован.
- ☞ Разблокированный подголовник **3** можно зафиксировать на необходимой высоте. Как только Вы отпустите ручку регулировки **8**, подголовник **3** зафиксируется.

DK

Brugsvejledning

5.2 Højdejustering af hovedstøtten



En korrekt indstillet hovedstøtte **3** sikrer, at diagonalselen **6** sidder optimalt og giver barnet den optimale komfort og sikkerhed. Hovedstøttens højde **3** kan indstilles i 5 positioner.

- Hovedstøtten **3** skal indstilles, så der er plads til fingre mellem barnets skuldre og hovedstøtten **3**

Hovedstøttens højde **3** indstilles efter barnets størrelse på følgende måde:

- ✎ Stil selehøjde-indstillingen **1** helt op til den øverste stilling (se 4.1).
- ✎ Lad barnet sætte sig i autostolen.
- ✎ Hold fast på bagsiden af hovedstøtten **3**, og træk hovedstøtte-indstillingen **8** op. Nu er hovedstøtten **3** låst op.
- ✎ Nu kan hovedstøtten **3** indstilles til den ønskede højde. Så snart hovedstøtte-indstillingen **8** slippes, går hovedstøtten **3** i hak.

NL

Gebruiksaanwijzing

5.2 Instelling van de hoogte van de hoofdsteun



Een goed afgestelde hoofdsteun **3** waarborgt de optimale positie van het schoudergedeelte van de gordel **6** en biedt uw kind de gewenste beveiliging en een heerlijk comfort. U kunt de hoogte van de hoofdsteun **3** in vijf standen vastklikken.

- De hoofdsteun **3** moet zo zijn afgesteld dat er tussen de schouders van uw kind en de hoofdsteun **3** nog twee vingers ruimte is.

U kunt de hoogte van de hoofdsteun **3** als volgt op de lichaamsgrootte van uw kind afstellen:

- ✎ Schuif de gordelhoogteverstelling **1** naar de bovenste stand (zie 4.1).
- ✎ Laat uw kind in het kinderzitje plaatsnemen.
- ✎ Grijp in de achterzijde van de hoofdsteun **3** en trek de hoofdsteunverstelling **8** naar boven. Nu is de hoofdsteun **3** ontgrendeld.
- ✎ U kunt nu de ontgrendelde hoofdsteun **3** op de gewenste hoogte instellen. Zodra u de verstelknop **8** loslaat, klikt de hoofdsteun **3** vast.



15 - 36 kg



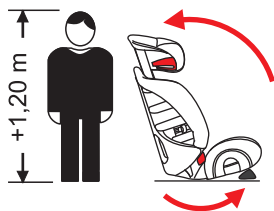

RUS

Инструкция по эксплуатации

5.3 Установка наклона детского автомобильного сиденья

Вы можете установить детское автомобильное сиденье в 2 положения, как описано в п. 4.2.



Внимание! Для детей выше 1,20 м применяйте сиденье EVOLVA 1-2-3 только в наклонном положении, распорный клин **21** должен быть наклонен вперед.



5.4 Пристегивание ребенка ремнями

Вы можете зафиксировать детское сиденье с помощью 3-точечного ремня, действуя следующим образом:

1. Закрепление ремня

Установите детское сиденье на сиденье автомобиля.

Внимание! Для детей выше 1,20 м установите сиденье в наклонное положение, распорный клин **21** наклоните вперед (см. 5.3).



DK

Brugsvejledning

5.3 Indstilling af autostolens hældning

Autostolen kan indstilles i to hældninger som beskrevet under 4.2.



Forsigtig! For børn med en størrelse på over 1,20 m må EVOLVA 1-2-3 kun anvendes i den tilbagelænedede stilling med afstandskilen **21** foran.



NL

Gebruiksaanwijzing

5.3 De hellingshoek van het autokinderzitje instellen

Zoals beschreven in 4.2, kunt u het kindersitje op twee hellingshoeken instellen.



Voorzichtig! Voor kinderen die langer zijn dan 1,20 m mag EVOLVA 1-2-3 in de achteroverleunstand alleen met het afstandsblokje **21** voor worden gebruikt.



15 - 36 kg

5.4 Fastspænding af barnet

Sådan sikrer du autostolen med køretøjets 3-punkt-sele:

1. Fastspænding af bilselen

Stil autostolen på bilsædet.

Forsigtig! Ved børn over 1,20 m må autostolen kun anvendes i tilbagelænet stilling med afstandskilen **21** foran (se 5.3).



5.4 De gordel bij uw kind omdoen

U kunt uw kind en het kindersitje met de driepuntsgordel van de auto als volgt vastzetten:

1. Autogordel omdoen

Plaats het kindersitje op de autostoel.

Let op! Gebruik bij kinderen die langer dan 1,20 m zijn, het kindersitje alleen in de achteroverleunstand met het afstandsblokje **21** voor (zie 5.3).



RUS

DK

NL

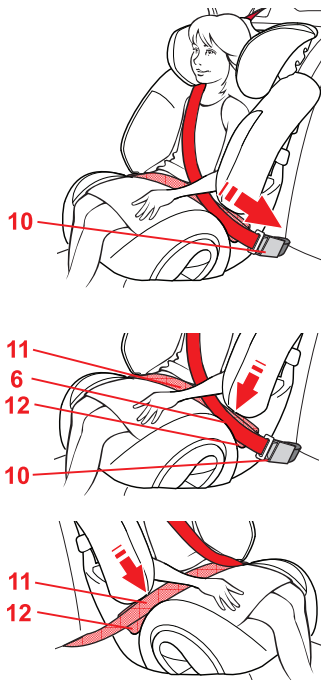

RUS

Инструкция по эксплуатации

- ✧ Усадите ребенка в детское сиденье.
- ✧ Вытяните автомобильный ремень и проведите его над ребенком к замку автомобильного ремня **10**.
Внимание! Не допускать скручивания ремня.
- ✧ Зафиксируйте язычки в замке автомобильного ремня **10**. ЩЕЛК!

2. Вставьте автомобильный ремень в красные направляющие ремня на детском сиденье.

- ✧ Вставьте диагональный ремень **6** и поясной ремень **11** со стороны замка ремня автомобиля **10** в красные направляющие ремня **12**.
Внимание! Замок автомобильного ремня **10** ни в коем случае не должен находиться в приемнике ремня ярко-красного цвета **12**.

- ✧ Вставьте поясной ремень **11** на другой стороне подушки сиденья в ярко-красную направляющую ремня **12**.
Внимание! Поясной ремень **11** должен проходить с обеих сторон через паховый гиб ребенка как можно ниже.



DK

Brugsvejledning

- ✧ Lad barnet sætte sig i autostolen.
- ✧ Træk bilselen ud, og træk den foran barnet til bilens selelås **10**.
Forsigtig! Pas på, at selen ikke snor sig.
- ✧ Lad låsetungen gå i hak i bilens selelås **10**.
KLIK!

2. Bilselen lægges i de røde seleføringer på autostolen.

- ✧ Læg diagonalselen **6** og hofseselen **11** på den side, hvor bilens selelås **10** er og ind i den lyserøde seleføring **12**.
Forsigtig! Bilens selelås **10** må ikke ligge på den lyserøde seleføring **12**.

- ✧ Læg også hofseselen **11** ind i den lyserøde seleføring **12** på den anden side.
Forsigtig! Hofseselen **11** skal sidde så tæt på barnets lysken som muligt på begge sider.

NL

Gebruiksaanwijzing

- ✧ Laat uw kind in het kinderzitje plaatsnemen.
- ✧ Trek de autogordel los en leid deze voor uw kind langs naar het gordelslot **10**.
Let op! Verdraai de gordel niet.
- ✧ Klik de gesp in het gordelslot **10** vast. KLIK!

2. Autogordel door de rode gordelgeleiders van het kinderzitje leiden.

- ✧ Leid het schoudergedeelte **6** en het heupgedeelte **11** van de autogordel aan de kant van gordelslot **10** door de lichtrode gordelgeleider **12**.
Let op! Het gordelslot **10** mag niet op de lichtrode gordelgeleider **12** liggen.

- ✧ Leid het heupgedeelte **11** van de gordel aan de andere zijde ook door de lichtrode gordelgeleider **12**.
Let op! Het heupgedeelte van de gordel **11** moet aan beide zijden zo laag mogelijk over de liezen van uw kind lopen.



15 - 36 kg

RUS

DK

NL

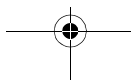
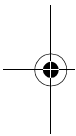
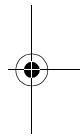

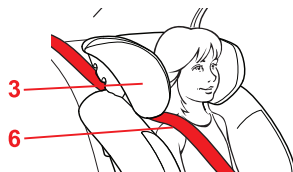
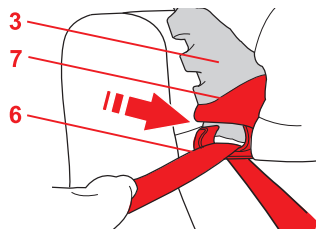

RUS

Инструкция по эксплуатации

- ✚ Протяните диагональный плечевой ремень безопасности **6** через темно-красный держатель ремня **7** подголовника **3** таким образом, чтобы он полностью находился в держателе ремня **7** и не был перекручен.

- ✚ Убедитесь в том, что диагональный ремень **6** проходит над ключицей ребенка и не прилегает к шее.
Полезный совет! Высоту подголовника **3** можно также отрегулировать в автомашине.
- ✚ **Внимание!** Диагональный ремень **6** должен проходить по диагонали назад.
Полезный совет! Прохождение ремня можно отрегулировать с помощью перемещаемого регулятора направления ремня автомашины.
- ✚ **Внимание!** Диагональный ремень **6** не должен подходить к регулятору направления ремня спереди.
Полезный совет! Используйте в этом случае другое заднее сиденье.
- ✚ Подтяните автомобильный ремень путем натяжения диагонального ремня **6**.



DK

Brugsvejledning

❖ Træk diagonalselen **6** ind i den mørkerøde seleholder **7** til hovedstøtten **3**, indtil den ligger helt i seleholderen **7** uden at dreje.

❖ Kontrollér, at diagonalselen **6** sidder over barnets kraveben og ikke på halsen.
Tip! Hovedstøtten **3** kan også indstilles i højden, mens autostolen er monteret i bilen.

❖ **Forsigtig!** Diagonalselen **6** skal gå skråt bagud.
Tip! Seleforløbet kan reguleres med den justerbare selestyring i bilen.

❖ **Forsigtig!** Diagonalselen **6** må aldrig føres frem til bilens selestyring.

Tip! Prøv i så fald et andet sæde på bagsædet.

❖ Stram bilselen ved at trække i diagonalselen **6**.

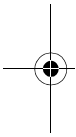

NL

Gebruiksaanwijzing

❖ Leid het schoudergedeelte **6** van de gordel in de donkerrode gordelhouder **7** van de hoofdsteun **3** totdat deze zich volledig en niet verdraaid in gordelhouder **7** bevindt.

❖ Controleer of het schoudergedeelte **6** van de gordel over het sleutelbeen van uw kind loopt en niet vast tegen de hals ligt.

Tip! U kunt de hoogte van de hoofdsteun **3** ook nog in de auto afstellen.

❖ **Voorzichtig!** Het schoudergedeelte **6** van de gordel moet schuin naar achteren lopen.

Tip! U kunt de weg van de gordel met de instelbare gordelomleider van uw auto regelen.

❖ **Let op!** Het schoudergedeelte **6** van de gordel mag nooit naar voren naar de gordelomleider in de auto lopen.

Tip! Probeer in dit geval een andere zitplaats op de achterbank.

❖ Trek de autogordel strak door aan het schoudergedeelte **6** te trekken.

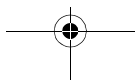

15 - 36 kg

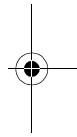

RUS

DK

NL

50



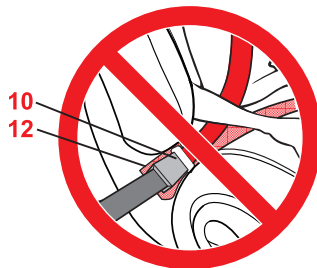
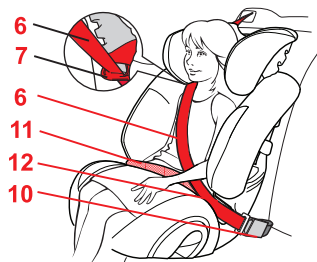

RUS

Инструкция по эксплуатации

5.5 Проверка безопасности ребенка



Для гарантии безопасности
Вашего ребенка убедитесь
в том, что...



- поясной ремень **11** проходит с обеих сторон через ярко-красные направляющие ремня **12**, расположенные на подушке сиденья,
- диагональный ремень **6** проходит со стороны замка автомобильного ремня **10** также через ярко-красную направляющую ремня **12**, расположенную на подушке сиденья,
- диагональный ремень **6** проходит через темно-красный держатель ремня **7** подголовника **3**,
- диагональный ремень **6** проходит по диагонали назад,
- ремни натянуты и не перекручены,
- автомобильный ремень **10** не лежит на светло-красной направляющей ремня **12** или на детском сиденье.

DK

Brugsvejledning

5.5 Sådan sikres barnet korrekt



Kontrollér for en sikkerheds skyld følgende...

- Hofseselen **11** sidder i de lyserøde seleføringer **12** på begge sider,
 - Diagonalselen **6** på siden, hvor bilens selelås **10** er, sidder også i den lyserøde seleføring **12**
 - Diagonalselen **6** går gennem den mørkerøde seleholder **7** på hovedstøtten **3**,
 - Diagonalselen **6** forløber skråt bagud,
 - Selerne er stramme og ikke snoede,
-
- Bilens selelås **10** sidder ikke på den lyserøde seleføring **12** eller på autostolen.



NL

Gebruiksaanwijzing

5.5 Zo is uw kind goed beveiligd



Controleer voor de veiligheid van uw kind of...

- het heupgedeelte **11** van de gordel aan beide zijden door de twee lichtrode gordelgeleiders **12** van het zitkussen loopt;
 - het schoudergedeelte **6** van de gordel aan de kant van het gordelslot **10** ook door de lichtrode gordelgeleider **12** loopt;
 - het schoudergedeelte **6** van de gordel door de donkerrode gordelhouder **7** van de hoofdsteun **3** loopt;
 - het schoudergedeelte **6** van de gordel schuin naar achteren loopt;
 - de gordels goed strak zitten en niet zijn verdraaid;
-
- het gordelslot **10** niet op de lichtrode gordelgeleider **12** of de zitkuip ligt.



15 - 36 kg

RUS

DK

NL

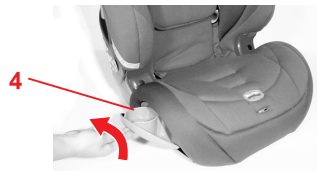
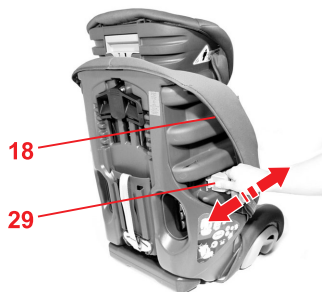

RUS

Инструкция по эксплуатации

6. EVOLVA 1-2-3 plus: Регулировка ширины спинки сиденья

Для спинки сиденья **29** Evolva 1-2-3 plus Вы можете регулировать ширину.

☞ Потяните светло-серые регуляторы ширины **24** на внешних сторонах боковин **18** вперед или назад в желаемое положение.

- **назад:** сиденье станет шире
- **вперед:** сиденье станет уже

7. Использование откидной подставки для напитков

Внимание! Чтобы избежать травм, ни в коем случае не используйте полку для...

- горячих напитков
- острых или заостренных предметов (например, карандашей)
- твердых и тяжелых предметов (например, алюминиевых фляг)

☞ Наклоняйте подставку для напитков **4** вверх и в сторону, пока она не зафиксируется.



DK

Brugsvejledning

6. EVOLVA 1-2-3 plus: Bredde-indstilling af ryglænet

Ryglænet **29** kan indstilles i bredde for Evolva 1-2-3 plus.

- ☞ Skub de to lysegrå bredde-indstillinger **24** på sidedelens yderside **18** frem eller tilbage til den ønskede stilling.
- **tilbage:** sædet bliver bredere
- **frem:** sædet bliver smallere

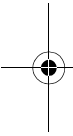

7. Brug af drikkeholdere, der kan drejes ud

Forsigtig! For at undgå ulykker må holderne aldrig bruges til...

- varme væsker
- skarpe eller spidse genstande (f.eks. blyanter)
- hårde og tunge genstande (f.eks. drikkeflasker af aluminium)

- ☞ Drej drikkeholderen **4** op og ud, til den går i hak.



NL

Gebruiksaanwijzing

6. EVOLVA 1-2-3 plus: Instelling van de breedte van de rugleuning

Bij de Evolva 1-2-3 plus kunt u de breedte van rugleuning **29** instellen.

- ☞ Schuif beide lichtgrijze breedteverstellers **24** aan de buitenzijde van het zijstuk **18** voorwaarts of achterwaarts naar de gewenste stand.
- **achterwaarts:** het zitje wordt breder
- **voorwaarts:** het zitje wordt smaller



7. Gebruik van de uitklapbare bekerhouder

Let op! Om letsel te voorkomen, dient u de opbergvakjes nooit te gebruiken voor...

- hete vloeistoffen
- scherpe of spitse voorwerpen (bijv. potloden)
- harde en zware voorwerpen (bijv. aluminium drinkflessen)

- ☞ Klap de bekerhouder **4** naar boven en buiten totdat deze vastklikt.

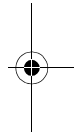

RUS

Инструкция по эксплуатации

8. Инструкция по уходу

Для сохранения защитной функции сиденья

- При дорожно-транспортном происшествии в результате столкновения или наезда на препятствие со скоростью свыше 10 км/ч в детском сиденье могут возникнуть повреждения, которые не всегда видны невооруженным глазом. В этом случае автомобильное детское сиденье следует заменить. Пожалуйста, правильно утилизируйте повреждённое сиденье (см. 9).
- Регулярно проверяйте все важные детали на предмет наличия повреждений. Убедитесь в том, что детали механической конструкции функционируют безупречно.
- Следите за тем, чтобы сиденье не было зажато между жесткими деталями конструкции автомобиля (двери, направляющие сидений и т.д.) или повреждено.
- Поврежденное сиденье (например, в результате падения) в обязательном порядке должно быть передано изготовителю для проверки.
- Не смазывайте детали детского сиденья.

DK

Brugsvejledning

8. Anvisninger til vedligeholdelse



Bevarelse af autostolens beskyttende virkning

- Ved uheld med en kollisionshastighed på over 10 km/t kan autostolen tage skade, uden at det kan ses.
Hvis det er tilfældet, skal autostolen udskiftes. Bortskaf den efter reglerne (se 9).
- Kontrollér med jævne mellemrum, at ingen af de vigtige dele har taget skade.
Kontrollér, at de mekaniske komponenter fungerer efter hensigten.
- Pas på, at autostolen ikke kommer i klemme mellem hårde bildele (f.eks. bildøren, glideskinne osv.) og på denne måde beskadiges.
- Autostole, som er blevet beskadiget (f.eks. fordi de er faldet ned), skal altid efterses af producenten.
- Smør eller oliér aldrig autostolens dele.

NL

Gebruiksaanwijzing

8. Onderhoudshandleiding



Voor het behoud van de beschermende werking

- Bij ongevallen waarbij de botsnelheid hoger dan 10 km/u is, kan het autokinderzitje beschadigd raken, hoewel de beschadigingen niet altijd zichtbaar hoeven te zijn.
In dergelijke gevallen moet het autokinderzitje worden vervangen. Voer het zitje volgens de geldende voorschriften af (zie 9).
- Controleer alle belangrijke onderdelen regelmatig op beschadiging.
Zorg ervoor dat de mechanische componenten vlekkeloos functioneren.
- Zorg ervoor dat het autokinderzitje niet tussen harde delen (portier, stoelrail, etc) klem komt te zitten en beschadigd raakt.
- Laat een autokinderzitje dat beschadigd is (bijv. als dit is gevallen) altijd door de fabrikant controleren.
- Smeer of olie nooit onderdelen van het kindersitje.





RUS

Инструкция по эксплуатации



- Бережно относитесь к детскому сиденью, если он не используется. Не ставьте на сиденье тяжелые вещи. Не храните сиденье вблизи от прямых источников тепла или прямых солнечных лучей.

8.1 Уход за замком ремня

От функционирования замка ремня существенно зависит безопасность сиденья. Неисправности замка ремня в большинстве случаев возникают вследствие его загрязнения.

Неисправность

- При нажатии красной кнопки язычки замка выскакивают с задержкой.
- Язычки замка не фиксируются (каждый раз выталкиваются снова).
- Язычки замка вставляются без слышимого щелчка.
- Смыкание язычков замка происходит с торможением (как в вязкой среде).

Замок ремня открывается с большим трудом.

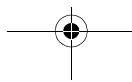
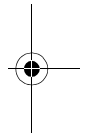
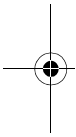



DK

Brugsvejledning

- Opbevar autostolen hensigtsmæssigt, når den ikke benyttes: Stil ikke tunge ting oven på den. Opbevar den aldrig i nærheden af direkte varmekilder eller i direkte sollys.

8.1 Pleje af selelåsen

En velfungerende selelås bidrager væsentligt til sikkerheden. Evt. fejlfunktioner ved selelåsen skyldes som regel snavs.

Funktionsfejl

- Låsetungerne er meget længe om at springe ud, når der trykkes på den røde knap.
- Låsetungerne går ikke i hak (hopper ud igen).
- Låsetungerne går i hak uden tydeligt "klik".
- Låsetungerne møder modstand (som om de trykkes ned i en dej).
- Der skal bruges mange kræfter for at åbne selelåsen.

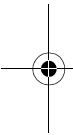

NL

Gebruiksaanwijzing

- Berg het kinderzitje zorgvuldig op als u deze niet gebruikt: Leg er geen zware dingen op. Sla het nooit op in de nabijheid van warmtebronnen of in direct zonlicht.

8.1 Het gordelslot onderhouden

Een goed werkend gordelslot is van wezenlijk belang voor de veiligheid. Problemen met de werking van het gordelslot zijn meestal het gevolg van verontreinigingen.

Problemen met de werking

- Als op de rode knop wordt gedrukt, komen de gespdelen slechts langzaam uit het slot.
- De gespdelen kunnen niet meer worden vastgeklikt (schieten weer los).
- Er is geen duidelijk klik hoorbaar als de gespdelen worden vastgeklikt.
- De gespdelen lopen bij het vastklikken aan (hiervoor is meer kracht dan gebruikelijk nodig).
- Het gordelslot kan alleen met grote krachtsinspanning worden geopend.

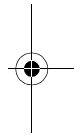

RUS

Инструкция по эксплуатации

Устранение неисправности

Чтобы замок ремня снова работал исправно, его следует промыть, действуя следующим образом:

1. Демонтаж замка ремня (см. 5.1)
2. Промывание замка ремня

✎ Положите замок ремня **15**, по меньшей мере, на 1 час в теплую воду с моющим средством. Затем промойте его и хорошо просушите.

3. Монтаж замка ремня

✎ Проденьте металлическую пластинку **19** сверху вниз ребром через паз для ремня **20** в чехле и через сиденье. Потяните с силой за замок ремня **15**, чтобы проверить его крепление.

✎ Закрепите перемещаемую прокладку **23**.

Неисправность

- Язычки **16** не вставляются в замок ремня **15**.

Устранение неисправности

✎ Нажмите на красную кнопку, чтобы разблокировать замок ремня **15**.

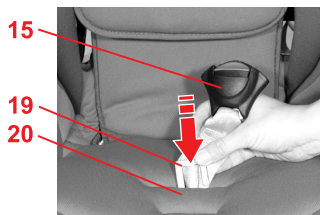



DK

Brugsvejledning

Modforanstaltning

Sådan vaskes selelåsen, så den fungerer fejlfrit igen:

1. Afmonter selelåsen (se 5.1)
2. Vask selelåsen
 - ✂ Læg selelåsen **15** i blød mindst 1 time i varmt sæbevand. Skyl låsen grundigt, og lad den tørre helt.
3. Montering af selelås
 - ✂ Skub metalpladen **19** på højkant oppefra og ned gennem seleslidsen **20** i betrækket og gennem autostolen.
Træk kraftigt i selelåsen **15** og kontrollér, om den er spændt og **sidder ordentligt fast**.
 - ✂ Fastgør skridtpolstringen **23**.

Funktionsfejl

- Låsetungerne **16** kan ikke føres ind i selelåsen **15**.

Modforanstaltning

- ✂ Tryk på den røde knap for at låse selelåsen **15** op.

NL

Gebruiksaanwijzing

Oplossing

Het gordelslot kan als volgt worden gereinigd zodat dit weer vlekkeloos functioneert:

1. Gordelslot uitbouwen (zie 5.1)
2. Gordelslot uitwassen
 - ✂ Leg het gordelslot **15** minimaal 1 uur in warm water met een milde zeepoplossing. Spoel het slot vervolgens uit en laat dit goed drogen.
3. Bouw het gordelslot in.
 - ✂ Schuif de metalen plaat **19** met de smalle kant van boven naar beneden door de gordelsleuf **20** in de bekleding **en door de zitkuip**.
Trek hard aan het gordelslot **15** om de **bevestiging te controleren**.
 - ✂ Bevestig de gordelslothes **23**.

Problemen met de werking

- De gespdelen **16** kunnen niet meer in het gordelslot **15** worden vastgeklikt.

Oplossing

- ✂ Druk op de rode knop om het gordelslot **15** te ontgrendelen.

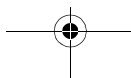
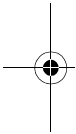
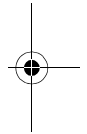

RUS

Инструкция по эксплуатации

8.2 Очистка

Вы должны проследить за тем, чтобы использовался только оригинальный запасной чехол фирмы Britax, поскольку этот чехол представляет собой существенную часть конструкции сиденья. Запасной чехол можно приобрести в специализированном магазине.



Запрещается эксплуатация детского сиденья **без чехла**.

- **Чехол** можно снимать и стирать в стиральной машине в щадящем режиме при температуре 30°C с использованием нейтрального моющего средства. Пожалуйста, соблюдайте указания по стирке, приведенные на этикетке чехла. При стирке с температурой выше 30°C материал чехла может полинять. Не разрешается отжим чехла в центрифуге, а также его сушка в электрической сушилке (ткань может отслоиться от набивки).
- **Пластмассовые детали** можно промывать в мыльном растворе. **Запрещается** применять сильнодействующие моющие средства (например, растворители).
- **Ремни** можно промывать в теплом мыльном растворе.

Внимание! Никогда не отделяйте язычки замка **16** от ремней.

DK

Brugsvejledning

8.2 Rengøring

Der må kun benyttes originale Britax-reservebetræk til autostolen, da de udgør en vigtig del af hele systemets funktion. Reservebetræk fås i specialforretningerne.



Autostolen må **ikke benyttes uden betræk**.

- **Betrækket** kan aftages og vaskes ved 30°C skåneprogram i vaskemaskinen med vaskemiddel til finvask. Følg anvisningerne på betrækkets vaskemærke. Hvis betrækket vaskes ved varmere temperaturer end 30°C, kan farverne løbe ud. Betrækket må ikke centrifugeres, og det må under ingen omstændigheder tørres i tørretumbleren (stoffet kan løsne sig fra polstringen).
- **Plastdelene** kan tørres af med sæbevand. **Undgå** brug af stærke rengøringsmidler (f.eks. opløsningsmidler).
- **Selerne** kan tørres af med lunkent sæbevand. **Forsigtig!** Fjern aldrig låsetungerne **16** fra selerne.

NL

Gebruiksaanwijzing

8.2 Reiniging

Gebruik bij vervanging uitsluitend originele Britax-bekleding. De bekleding is van wezenlijk belang voor de werking van het systeem. Vraag hiernaar bij de vakhandel.



Het autokinderzitje mag **niet zonder bekleding** worden gebruikt.

- De **bekleding** kan worden verwijderd en in de wasmachine worden gewassen met een fijnwasprogramma op 30°C en een fijnwasmiddel. Let op de aanwijzingen op het wasetiket van de bekleding. Als de bekleding op meer dan 30°C wordt gewassen, verkleurt de stof mogelijk. De bekleding mag niet worden gecentrifugeerd of in een elektrische wasdroger worden gedroogd (hierdoor kan de stof van de vulling losraken).
- De **kunststofdelen** kunnen met een zeepoplossing worden gereinigd. Gebruik **geen** bijtende middelen (zoals oplosmiddelen).
- De **gordels** kunnen met een lauwwarme zeepoplossing worden gereinigd. **Voorzichtig!** De gespdelen **16** mogen nooit van de gordels worden losgemaakt.

RUS

DK

NL

RUS

Инструкция по эксплуатации

- Вы можете демонтировать **плечевые накладки 23** и стирать их в теплой воде с использованием мыльного раствора.
Внимание! Плечевые накладки **23** уменьшают риск получения травм Вашим ребёнком при аварии. Пользуйтесь детским автокреслом только при наличии этих плечевых накладок **14**.

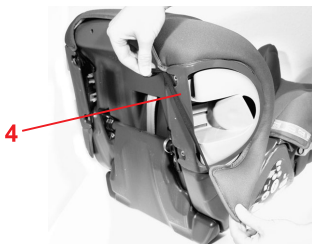

8.3 Снятие чехла

- ✎ Снимите ремень, как описано в п. 5.1.
- ✎ Надавите вверх на подголовник **3**.
- ✎ Отцепите кайму чехла и резиновые петли под краем сиденья.
- ✎ Снимите чехол подголовника **3**.
- ✎ Снимите резиновые петли чехла на подставке для напитков **4**.
- ✎ Уплотните чехол с углублением через подголовник **3**.



DK

Brugsvejledning

- **Skulderpolstringerne 23** kan tages af og vaskes i luncent sæbevand.
Forsigtig! Skulderpolstringerne **23** reducerer risikoen for, at dit barn kommer til skade ved en ulykke. Brug kun autostolen sammen med disse skulderpolstringer **14**.

8.3 Aftagning af betrækket

- ✎ Tag selen af som beskrevet (se 5.1).
- ✎ Stil hovedstøtten **3** helt op.
- ✎ Tag betrækkets kant og gummistropperne under autostolens kant af.
- ✎ Tag betrækket til hovedstøtten **3** af.

- ✎ Tag gummistropperne til betrækket ved drikkeholderen **4** af på sædets underside.
- ✎ Træk betrækket med udskæringen over hovedstøtten **3**.

NL

Gebruiksaanwijzing

- De **schouderkussentjes 23** kunnen worden uitgebouwd en met een lauwwarme zeepoplossing worden gereinigd.
Voorzichtig! De schouderkussentjes **23** verlagen de kans op verwondingen bij uw kind bij een ongeval. Gebruik het autokinderzitje uitsluitend met deze schouderkussentjes **14**.

8.3 De bekleding verwijderen

- ✎ Maak de gordels los zoals beschreven (zie 5.1).
- ✎ Breng de hoofdsteun **3** helemaal omhoog.
- ✎ Maak de zoomranden en rubberen lussen onder de rand van het kinderzitje los.
- ✎ Verwijder de bekleding van de hoofdsteun **3**.

- ✎ Maak aan de onderzijde van het zitje de rubberen lussen van de bekleding bij de bekerhouder **4** los.
- ✎ Trek de bekleding met de uitsparing over de hoofdsteun **3**.

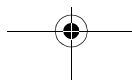
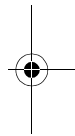

RUS

Инструкция по эксплуатации

8.4 EVOLVA 1-2-3 plus: Снятие чехла

- ✎ Ослабьте ремень (см. пункт 4.5).
- ✎ Откройте текстильную застежку на перемещаемой подкладке **23** и снимите ее.
- ✎ Откройте кнопки **5** слева и справа от чехла спинки сиденья **29** и подголовника **3**.
- ✎ Отцепите кайму чехла и резиновые петли под краем сиденья.
- ✎ Снимите чехол подголовника **3**.
- ✎ Вытяните замок ремня **15** и конец ремня **17** из чехла.
- ✎ Снимите резиновые петли чехла на подставке для напитков **4**.
- ✎ Уплотните чехол с углублением через подголовник **3**.

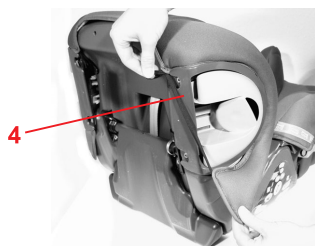
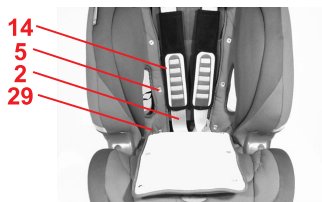



DK

Brugsvejledning

8.4 EVOLVA 1-2-3 plus: Aftagning af betrækket

- ✂ Løsn skulderselerne (se 4.5).
- ✂ Åbn velcrobåndet ved skridtpolstringen **23** og tag den af.
- ✂ Åbn trykknapperne **5** til venstre og højre på betrækket til ryglænet **29** og hovedstøtten **3**.
- ✂ Tag betrækkets kant og gummistropperne under autostolens kant af.
- ✂ Tag betrækket til hovedstøtten **3** af.
- ✂ Tag selelåsen **15** og indstillingsselen **17** ud af betrækket.
- ✂ Tag gummistropperne til betrækket ved drikkeholderen **4** af på sædets underside.
- ✂ Træk betrækket med udskæringen over hovedstøtten **3**.

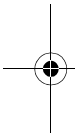

NL

Gebruiksaanwijzing

8.4 EVOLVA 1-2-3 plus: De bekleding verwijderen

- ✂ Maak de schoudergordels losser (zie 4.5).
- ✂ Open de klittenbandsluiting van de gordelslothes **23** en verwijder deze.
- ✂ Maak de drukknopen **5** links en rechts op de bekleding van de rugleuning **29** en de hoofdsteun **3** los.
- ✂ Maak de zoomranden en rubberen lussen onder de rand van het kinderzitje los.
- ✂ Verwijder de bekleding van de hoofdsteun **3**.
- ✂ Trek het gordelslot **15** en de verstelgordel **17** uit de bekleding.
- ✂ Maak aan de onderzijde van het zitje de rubberen lussen van de bekleding bij de bekerhouder **4** los.
- ✂ Trek de bekleding met de uitsparing over de hoofdsteun **3**.

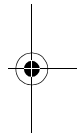

RUS

Инструкция по эксплуатации

8.5 Надевание чехла

- ✎ Все описанные операции следует выполнить в обратной последовательности согласно 8.3/8.4.
- ✎ **Внимание!** Убедитесь в том, что ремни не запутаны и правильно вложены в пазы ремней чехла.

8.6 Монтаж ремней

- ✎ Вставьте металлическую пластину **19** ребром сверху вниз через паз для ремня **20**.
Внимание! Потяните с силой за замок ремня **15** чтобы проверить его крепление.
- ✎ Заправьте в чехол плечевые ремни **2** вместе с язычками замка **16**.
- ✎ Закрепите перемещаемую прокладку **23**.
- ✎ Вставьте язычки с защелкиванием **16** в замок ремня (см 5.4).
Внимание! Не допускать перекручивания или перепутывания ремней.

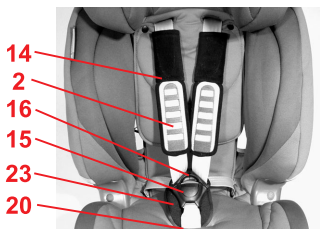
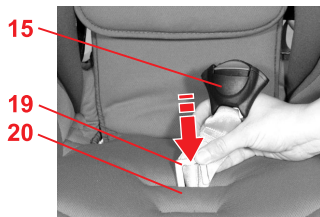



DK

Brugsvejledning

8.5 Påsætning af betrækket

- ✎ Gå frem i omvendt rækkefølge som beskrevet under 8.3/8.4.
- ✎ **Forsigtig!** Kontrollér, at selerne ikke er snoede, og at de er sat rigtigt ind i betrækkets seleslids.

8.6 Montering af selerne

- ✎ Sæt metalpladen **19** på højkant oppefra og ned gennem seleslidsen **20**.
Forsigtig! Træk kraftigt i seleslåsen **15** og kontrollér, om den er spændt ordentligt fast.
- ✎ Sæt skulderselerne **2** med låsetungerne **16** ind i betrækket.
- ✎ Fastgør skridtpolstringen **23**.
- ✎ Sæt låsetungerne **16** i hak i seleslåsen (se 5.4).
Forsigtig! Selerne må ikke snos, og der må ikke byttes om på dem.

NL

Gebruiksaanwijzing

8.5 De bekleding bevestigen

- ✎ Ga gewoon in de omgekeerde volgorde zoals beschreven in 8.3/8.4 te werk.
- ✎ **Voorzichtig!** Zorg ervoor dat de gordels niet verdraaid zijn en wel op de juiste wijze in de gordelsleuven zijn gestoken.

8.6 Inbouw van de gordels

- ✎ Schuif de metalen plaat **19** met de smalle kant van boven naar beneden door de gordelsleuf **20**.
Voorzichtig! Trek hard aan het gordelslot **15** om de bevestiging te controleren.
- ✎ Trek de schoudergordels **2** met de gespden **16** door de bekleding.
- ✎ Bevestig de gordelslothes **23**.
- ✎ Klik de gespden vast **16** in het gordelslot (zie 5.4).
Voorzichtig! Verdraai de schoudergordels niet en wissel deze ook niet om.

RUS

DK

NL

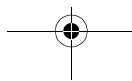
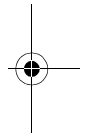

RUS

Инструкция по эксплуатации

- ✧ Наденьте плечевые подкладки **14** на плечевые ремни **2**.
- ✧ Поверните вверх дугу для ношения **8** детского сиденья (см. 5.2).
- ✧ Проденьте петли ремня плечевых подкладок **14** в пазы для ремня.
- ✧ Петли ремня плечевых подкладок **14** переместите на перемычку **28** регулятора подголовника **21**.
- ✧ Проденьте плечевые ремни **2** в пазы для ремня **5** и регулятор высоты ремня **1**.
Внимание! Не допускать перекручивания или перепутывания ремней.
- ✧ Снова заправьте плечевые ремни **2** в соединительный элемент **22**.

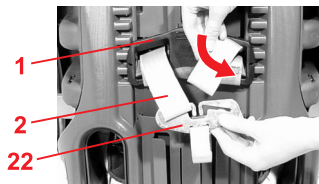
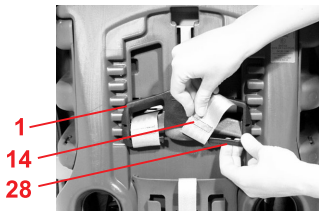



DK

Brugsvejledning

- ✎ Sæt skulderpolstringerne **14** på skulderselerne **2**.
- ✎ Stil hovedstøtte-indstillingen **8** på den nederste stilling (se 5.2).
- ✎ Sæt skulderpolstringernes selestropper **14** ind i seleslidserne.
- ✎ Skub skulderpolstringernes selestropper **14** op på mellemstykket **28** til selehøjde-indstillingen **21**.
- ✎ Sæt skulderselerne **2** ind i seleslidsen **5** og i selehøjde-indstillingen **1**.
Forsigtig! Selerne må ikke snos, og der må ikke byttes om på dem.
- ✎ Sæt skulderselerne **2** ind i forbindelsesdelen **22** igen.

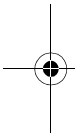

NL

Gebruiksaanwijzing

- ✎ Schuif de schouderkussentjes **14** over de schoudergordels **2**.
- ✎ Schuif de hoofdsteunverstelling **8** naar de onderste stand (zie 5.2).
- ✎ Schuif de gordellussen van de schouderkussentjes **14** door de gordelsleuven.
- ✎ Schuif de gordellussen van de schouderkussentjes **14** op het verbindingsstuk **28** van de gordelhoogteverstelling **21**.
- ✎ Schuif de schoudergordels **2** in de gordelsleuven **5** en de gordelhoogteverstelling **1**.
Voorzichtig! Verdraai de schoudergordels niet en wissel deze ook niet om.
- ✎ Bevestig de schoudergordels **2** weer aan het verbindingsstuk **22**.

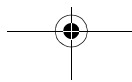
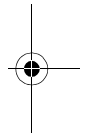



RUS

Инструкция по эксплуатации

9. Указания по утилизации

Пожалуйста, соблюдайте предписания по утилизации, действующие в Вашей стране.

Утилизация упаковочных материалов	
	Контейнер для картона
Утилизация отдельных деталей	
Чехол	Прочие отходы, использование для регенерации тепла
Пластмассовые детали	согласно маркировке в предусмотренные для этого контейнеры
Металлические детали	Контейнер для металлолома
Замок и язычок	Прочие отходы

10. Двухгодичная гарантия

На это автомобильное/велосипедное детское сиденье мы предоставляем двухгодичную гарантию на отсутствие брака изготовления или дефектов материала. Гарантийный срок исчисляется с момента покупки.

Для подтверждения сохраняйте заполненный гарантийный талон, подписанный Вами

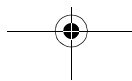
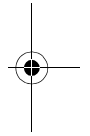
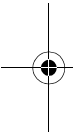

DK

Brugsvejledning

9. Affaldsdeponering

Følg forskrifterne i dit land.

Deponering af emballagen	
	Container til pap
Deponering af enkeltdele	
Betræk	Restaffald, termisk forarbejdning
Plastdele	I containere i henhold til mærkningen
Metaldele	Container til metal
Lås og tunge	Restaffald

10. 2 års garanti

På denne autostol/cykelstol giver vi 2 års garanti på fabriktions- eller materialefejl. Garantiperioden begynder den dag, produktet købes. Du bedes i hele garantiperioden opbevare det udfyldte garantibevis, udleveringsbeviset, som er underskrevet af dig samt købskvitteringen.

NL

Gebruiksaanwijzing

9. Instructies voor de afvoer

Houd u aan de in uw land geldende afvoervoorschriften.

Afvoer van de verpakking	
	Bij het oud papier
Afvoer van de afzonderlijke delen	
Bekleding	Huisvuil, thermische verwerking
Kunststofdelen	Overeenkomstig de aanduiding op het deel in de daarvoor bestemde container
Metalen delen	Container voor metaal
Slot en gespdelen	Huisvuil

10. 2 jaar garantie

Wij geven 2 jaar garantie op fabricage- en materiaalfouten in deze auto-/fietskinderzitjes. De garantieperiode gaat in op de datum van aankoop. Bewaar om aanspraak op de garantie te kunnen maken de ingevulde garantiekaart, de door u ondertekende overdrachtscontrole en het aankoopbewijs gedurende de gehele garantieperiode.





RUS

Инструкция по эксплуатации

формуляр контроля при покупке, а также торговый чек на весь период действия гарантийных обязательств.

При представлении рекламаций к сиденью должен быть приложен гарантийный талон. Гарантийные обязательства распространяются только на детские автомобильные/велосипедные сиденья, с которыми обращались надлежащим образом, и которые были отправлены обратно в чистом и аккуратном виде.

Гарантийные обязательства не распространяются:

- на естественной износ, а также на повреждения, вызванные чрезмерной нагрузкой
- на повреждения, возникшие как следствие применения не по назначению или неправильной эксплуатации

Действует гарантия или нет?

Материалы: Все наши материалы отвечают жестким требованиям к сохранению цвета под воздействием УФ-излучения. Несмотря на это, все материалы, подвергающиеся воздействию УФ-излучения, выцветают.

При этом речь идет не о дефектах материалов, а о естественных признаках износа, на которые гарантийные обязательства не распространяются.

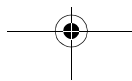
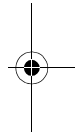
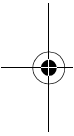



DK

Brugsvejledning

I forbindelse med evt. reklamationer skal garantibeviset vedlægges autostolen. Garantien ydes kun, hvis autostolen/cykelstolen er blevet behandlet med den fornødne omhu og returneres i ren og ordentlig stand.

Garantien dækker ikke:

- naturlig slitage samt skader, der er opstået som følge af for voldsom belastning.
- skader, der er opstået, fordi autostolen er blevet behandlet forkert eller anvendes i modstrid med det egentlige formål.

Garanti eller ej?

Stoffer: Alle vore stoffer opfylder meget strenge krav, hvad angår deres farveægthed i forhold til UV-stråler. Alligevel vil stoffernes farver falme, hvis de udsættes for UV-stråler. Der er her tale om normalt slid og ikke om materialefejl, og det er derfor ikke omfattet af garantien.

NL

Gebruiksaanwijzing

Bij het indienen van een garantieclaim dient het garantiebewijs met het kinderzitje te worden meegestuurd. De garantie is alleen van toepassing op auto-/fietskinderzitjes waar juist mee is omgegaan en die in schone en goede staat worden teruggezonden.

Uitgesloten van garantie zijn:

- normale tekenen van slijtage en schade ten gevolge van overmatige belasting
- schade ten gevolge van onbedoeld of onjuist gebruik

Garantie of niet?

Stoffen: Al onze stoffen voldoen aan hoge eisen wat betreft de kleurbestendigheid tegen UV-straling. Alle stoffen verbleken echter als deze aan UV-straling worden blootgesteld. Hierbij gaat het niet om materiaalfouten, maar om normale slijtageverschijnselen die van garantie zijn uitgesloten.

RUS

DK

NL

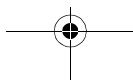



RUS

Инструкция по эксплуатации

Замок: Неисправности замка в большинстве случаев вызваны загрязнением, которое можно удалить промыванием. В своих действиях руководствуйтесь, пожалуйста, настоящей инструкцией по эксплуатации.

В случаях, требующих предоставления услуг по гарантии, немедленно обращайтесь в специализированный магазин, продавший Вам этот товар. Там Вам будет оказана помощь словом и делом. При обработке рекламаций применяются нормы амортизации для конкретного изделия. Здесь мы обращаем Ваше внимание на общие условия сделки, с которыми можно ознакомиться у продавца.

Применение, уход и техническое обслуживание

При обращении с автомобильным/велосипедным детским сиденьем необходимо соблюдать инструкции по эксплуатации. Мы настоятельно обращаем Ваше внимание на то, что использоваться могут только оригинальные запасные части или принадлежности.

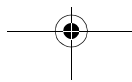
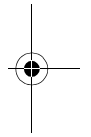
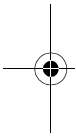



DK

Brugsvejledning

Lås: Hvis der konstateres funktionsfejl på selelåsen, skyldes det som regel snavs, der kan vaskes væk. Følg altid anvisningerne i betjeningsvejledningen.

Hvis du ønsker at gøre brug af garantien, bedes du henvende dig til en specialforretning. Her vil du blive vejledt af professionelle fagfolk. Ved reklamationer bruges der produktspecifikke afskrivningssatser. Vi gør i den forbindelse opmærksom på vores Almindelige Forretningsbetingelser, som du kan få udleveret hos forhandleren.

Anvendelse, pleje og vedligeholdelse

Autostolen til bilen/cyklen skal behandles i overensstemmelse med betjeningsvejledningen. Vi gør udtrykkeligt opmærksom på, at der kun må benyttes originalt tilbehør / reservedele.

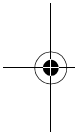

NL

Gebruiksaanwijzing

Slot: Eventuele problemen met het gordelslot zijn meestal het gevolg van verontreiniging die kunnen worden verwijderd door het slot met water te reinigen. Houd u zich hierbij aan de instructies in uw gebruiksaanwijzing.

Neem, als uw kinderzitje nog onder de garantie valt, onmiddellijk contact op met uw vakhandel. Hier wordt u met raad en daad terzijde gestaan. Bij de behandeling van garantieclaims worden productspecifieke afschrijvingsregels toegepast. Hiervoor verwijzen wij u naar de bij de vakhandel verkrijgbare algemene voorwaarden.

Gebruik, onderhoud en verzorging

Het auto-/fietskinderzitje moet overeenkomstig de gebruiksaanwijzing worden gebruikt en onderhouden. Wij wijzen er nadrukkelijk op dat uitsluitend originele accessoires en onderdelen mogen worden gebruikt.

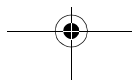
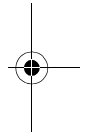

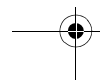
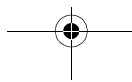
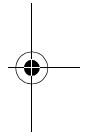
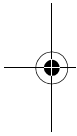
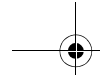



RUS

11. Гарантийный талон / Формуляр контроля при покупке

Фамилия:

Адрес:

Почтовый индекс:

Город:

Телефон (с кодом
страны, города):

Электронная почта:

Автомобильное/
велосипедное детское
сиденье:

Номер артикула:

Цвет материала (узор):

Принадлежности:

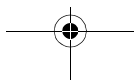
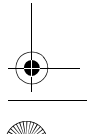
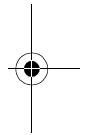

RUS

Формуляр контроля при покупке:

- 1. Комплектность** проверено / в порядке Я проверил автомобильное/ велосипедное детское сиденье и удостоверился в том, что сиденье передано мне в полном комплекте, и что все его функции действуют в полном объеме.
- 2. Функциональный контроль**
- Механизм регулировки сиденья проверено / в порядке Я получил достаточную информацию об изделии и его функциях перед покупкой и принял к сведению указания по эксплуатации и техническому обслуживанию.
- Регулировка ремней проверено / в порядке
- 3. Сохранность**
- Контроль сиденья проверено / в порядке
- Контроль матерчатых элементов проверено / в порядке
- Контроль пластмассовых деталей проверено / в порядке

Дата покупки: _____

Покупатель (подпись): _____

Продавец: _____

Штамп продавца





DK

11. Garantibevis / udleveringskontrol

Navn:

Adresse:

Postnummer:

By:

Telefon (inkl. omr.-nr.):

E-mail:

Barnestol til bilen/cyklen:

Artikelnummer:

Stoffarve (dessin):

Tilbehør:

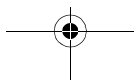
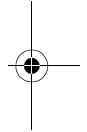
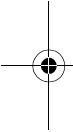



DK

Udleveringskontrol:

1. Fuldstændighed

afprøvet / i orden

Jeg har afprøvet autostolen til bilen/cyklen og forvissat mig om, at jeg har fået udleveret samtlige dele, og at stolen er fuldt funktionsdygtig.

2. Funktionskontrol

- Justeringsmekanisme sæde

afprøvet / i orden

- Selejustering

afprøvet / i orden

Jeg har modtaget omfattende informationer om produktet og dets funktioner inden køb og taget pleje- og vedligeholdelsesanvisningerne til efterretning.

3. Ubeskadiget tilstand

- Kontrol af sæde

afprøvet / i orden

- Kontrol af stofdele

afprøvet / i orden

- Kontrol af plastdele

afprøvet / i orden

Købsdato:

Køber (underskrift):

Forhandler:

Forhandlerens stempel

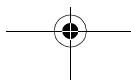



NL

11. Garantiekaart/overdrachtscontrole

Naam:

Adres:

Postcode:

Plaats:

Telefoon (incl.
netnummer):

E-mail:

Auto-/fietskinderzitje:

Artikelnummer:

Kleur stof (dessin):

Accessoires:

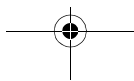

NL

Overdrachtscontrole:

1. Volledigheid

- gecontroleerd / in orde Ik heb het auto-/fietskinderzitje gecontroleerd en mijzelf ervan overtuigd dat het zitje compleet en volledig functionerend aan mij is overgedragen.

2. Controle van de werking

- Verstelmecanisme zitje gecontroleerd / in orde

- Gordelverstelling gecontroleerd / in orde

- Ik heb voorafgaand aan de aankoop voldoende informatie over het product en de werking ervan gekregen en ben op de hoogte gesteld van de onderhouds- en verzorgingsvoorschriften.

3. Controleren op beschadigingen

- Zitje controleren gecontroleerd / in orde

- Stoffen delen controleren gecontroleerd / in orde

- Kunststofdelen controleren gecontroleerd / in orde

Datum van aankoop: _____

Klant (handtekening): _____

Verkopers: _____



Stempel vakhandel

