

Contents

1	Instructions	30
1.1	General safety instructions	30
1.2	Appliance purpose	32
1.3	Disposal	33
1.4	Identification plate	34
1.5	This user manual	34
1.6	How to read the user manual	34
2	Description	35
2.1	General Description	35
2.2	Description of parts	36
2.3	Control panel	37
3	Use	38
3.1	Instructions	38
3.2	Preliminary operations	38
3.3	First use	38
3.4	Using the control panel	39
3.5	Using the wine cellar compartments	42
3.6	Alarms	44
3.7	Food storage advice	45
4	Cleaning and maintenance	48
4.1	Instructions	48
4.2	Cleaning the appliance	48
4.3	What to do if...	50
5	Installation	51
5.1	Electrical connection	51
5.2	Positioning	51

Apple, App Store and iOS marks belong to Apple Inc.
Google Play Store and Android marks belong to Google Inc.
Wi-Fi is a mark belonging to Wi-Fi Alliance.

TRANSLATION OF THE ORIGINAL INSTRUCTIONS

We advise you to read this manual carefully, as it contains all the instructions for maintaining the appliance's aesthetic and functional qualities.

For further information on the product: www.smeg.com



Instructions

1 Instructions

1.1 General safety instructions

Risk of personal injury

- Keep children under the age of 8 at a safe distance unless they are constantly supervised.
- Children must never play with the appliance.
- Never try to put out a fire or flames with water: turn off the appliance and smother the flames with a fire blanket or other appropriate cover.
- Cleaning and maintenance must not be carried out by unsupervised children.
- Have qualified personnel carry out installation and assistance interventions according to the standards in force.
- Do not modify this appliance.
- Do not insert pointed metal objects (cutlery or utensils) into the slots in the appliance.
- Do not try to repair the appliance yourself or without the intervention of a qualified technician.
- Do not pull the cable to remove the plug.
- If the power supply cable is damaged, contact technical support immediately and they will replace it.
- If it is necessary to replace the power cable, **this must be performed by an authorised technician from Technical Support Service.**
- DO NOT USE OR STORE FLAMMABLE MATERIALS NEAR THE APPLIANCE.
- DO NOT USE AEROSOLS IN THE VICINITY OF THIS APPLIANCE WHILST IT IS IN USE.
- DO NOT MODIFY THIS APPLIANCE.
- Have qualified personnel carry out installation and assistance interventions according to the standards in force.



Risk of damaging the appliance

- Never rest sharp metal objects such as knives, forks, spoons and lids on the appliance during use.
- Do not use abrasive or corrosive detergents (e.g. scouring powders, stain removers and metallic sponges) on glass parts.
- Do not use rough or abrasive materials or sharp metal scrapers.
- Do not sit on the appliance.
- Do not rest any weight or sit on the open door of the appliance.
- Take care that no objects are stuck in the doors.
- Do not store inflammable, explosive or volatile substances.
- Organic compounds, acids and essential oils can corrode the seals and plastic surfaces if left in contact with them for extended periods.
- Bottles with a high alcohol content must be tightly closed.
- Do not use steam jets to clean the appliance.
- Do not spray any spray product near the appliance.
- Do not obstruct ventilation openings and heat dispersal slots.
- Do not use electrical appliances inside food storage compartments unless these are of the type recommended by the manufacturer.
- **DO NOT USE THE APPLIANCE TO COOL ROOMS FOR ANY REASON.**
- Never use mechanical devices or any other means not recommended by the manufacturer to accelerate the defrosting process.
- Always unplug the appliance in the event of a fault or when performing cleaning or maintenance.
- Never use the oven door to lever the appliance into place when fitting.
- Avoid exerting too much pressure on the door when open.
- Do not use the handle to lift or move this appliance.



Instructions

Installation and maintenance

- THIS APPLIANCE **MUST NOT BE INSTALLED** IN A BOAT OR CARAVAN.
- This appliance must not be installed on a pedestal.
- Position the appliance into the cabinet cut-out with the help of a second person.
- To prevent any possible overheating, the appliance should not be installed behind a decoration door or a panel.
- Have qualified personnel carry out installation and assistance interventions according to the standards in force.
- Have the electrical connection performed by authorised technicians.
- The appliance must be connected to ground in compliance with electrical system safety standards.
- Use cables withstanding a temperature of at least 90 °C.
- The tightening torque of the screws of the terminal board leads must be 1.5 - 2 Nm.

- Before any operation on the appliance (installation, maintenance, positioning or movement) always wear PPM.
- Before performing any operation on the appliance, switch off the power supply.

1.2 Appliance purpose

- This appliance has been designed exclusively for storing wine in a domestic setting. Every other use is considered inappropriate.
- This appliance may be used by children aged at least 8 and by people of reduced physical, sensory or mental capacity, or lacking in experience in the use of electrical appliances, provided that they are supervised or instructed by adults who are responsible for their safety.
- This appliance is not suitable for use by persons (including children) with reduced physical, sensory or mental capacity, or by those without experience or knowledge, unless they are supervised or instructed on the use of the appliance by a person responsible for their safety.



- Children should be supervised to ensure that they do not play with the appliance.
- Do not install/use the appliance outdoors.
- The appliance is not designed to operate with external timers or with remote-control systems.

The appliance is designed for use in a domestic or similar environment, for instance:

- Staff kitchen areas in shops, offices and other working environments;
- Farm houses and by guests in hotels, motels and other residential type environments;
- bed and breakfast establishments;
- catering and similar non-retail applications.

1.3 Disposal



This appliance must be disposed of separately from other waste (Directives 2002/95/EC, 2002/96/EC, 2003/108/EC).

The appliance does not contain substances in quantities sufficient to be considered hazardous to health and the environment, in accordance with current European directives.

To dispose of the appliance:

- Cut the power supply cable and remove it along with the plug.



Power voltage

Danger of electrocution

- Disconnect the mains power supply.
- Unplug the appliance.
- Deliver the appliance to the appropriate recycling centre for electrical and electronic equipment waste, or return it to the retailer when purchasing an equivalent product, on a one for one basis.



Instructions

Our appliances are packaged in non-polluting and recyclable materials.

- Deliver the packing materials to the appropriate recycling centre.



Plastic packaging Danger of suffocation

- Do not leave the packaging or any part of it unattended.
- Do not let children play with the plastic bags.

1.4 Identification plate

The identification plate bears the technical data, serial number and brand name of the appliance. Do not remove the identification plate for any reason.

1.5 This user manual

This user manual is an integral part of the appliance and must therefore be kept in its entirety and within the user's reach for the whole working life of the appliance.

Read this user manual carefully before using the appliance.

1.6 How to read the user manual

This user manual uses the following reading conventions:

Instructions



General information on this user manual, on safety and final disposal.

Description



Description of the appliance and its accessories.

Use



Information on the use of the appliance and its accessories.

Cleaning and maintenance



Information for proper cleaning and maintenance of the appliance.

Installation



Information for the qualified technician: Installation, operation and inspection.



Safety instructions



Information



Advice

1. Sequence of instructions for use.

- Standalone instruction.



2 Description

2.1 General Description

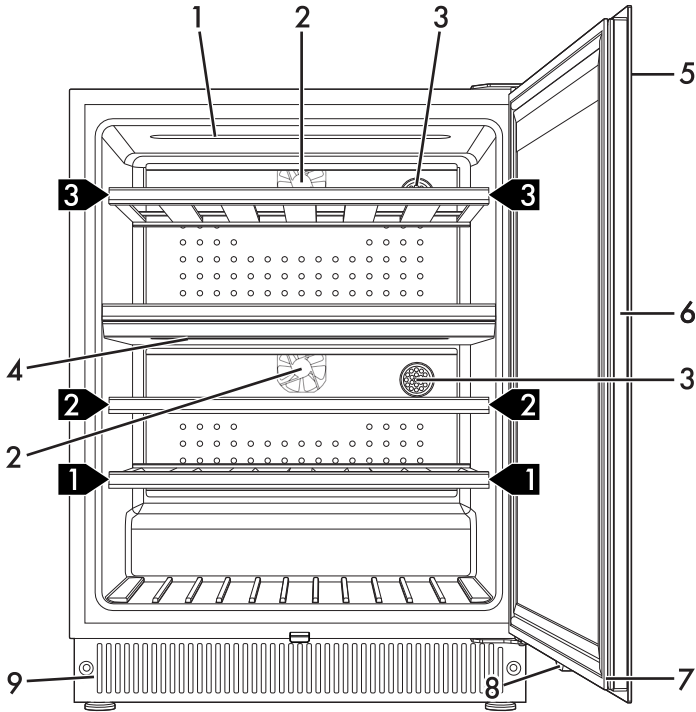

1 Upper compartment interior lighting

2 Fan (not visible)

3 Activated charcoal filter

4 Lower compartment interior lighting

5 Control panel

6 Door

7 Door seal

8 Magnet

9 Ventilation grille

1,2,3 Removable shelf

EN



Description

2.2 Description of parts

Smeg Connect

The appliance is equipped with the **Smeg Connect** technology so that the user can control its operation through an App on his smartphone or PC tablet.

For further information, refer to the supplied brochure and/or visit the site

www.smeg.com

Interior lighting

The interior lighting of the appliance turns on when the door is opened (maximum brightness) or when the Light Key  on the control panel is pressed (medium brightness).

Activated charcoal filters

Ensure optimum air quality for wine storage.

Fans (not visible)

Distribute the temperature and reduce condensation on the shelves and other surfaces.

Removable shelves

The removable shelves allow easy removal of the bottles of wine.

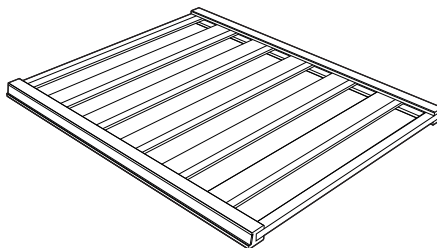

Fixed shelf

The fixed shelf is designed to hold bottles of champagne and sparkling wines or other bottles with a diameter larger than that of normal wines.

The lower compartment LED lighting is located beneath the fixed shelf.

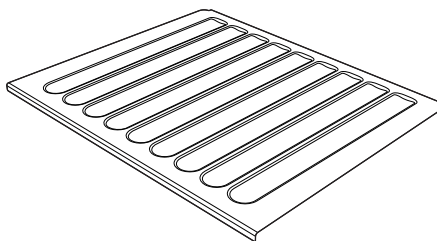

When the fans are on, the power consumption increases.

Door

Fitted with a seal and magnet, this provides perfect insulation of the wine cellar from the surrounding environment.



2.3 Control panel

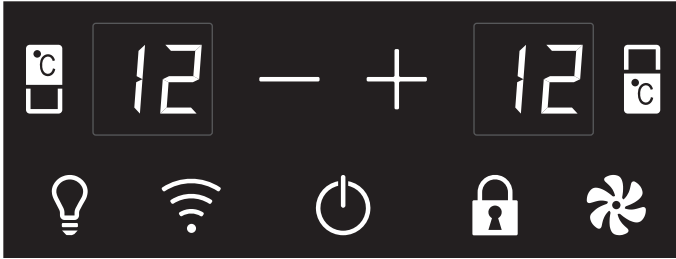

The control panel allows the user to interact with the appliance. Touch the keys with symbols to access the available functions.

Upper cellar display key

The display shows the temperature inside the upper wine cellar.

Decrease key

This key lowers the temperature inside the upper or lower compartment.

Increase key

This key increases the temperature inside the upper or lower compartment.

Lower cellar display key

The display shows the temperature inside the lower wine cellar.

Light key

This key turns the lighting inside the wine cellar on and off. The lighting turns off after a maximum period of 15 minutes.

Connection key

By this key you can activate the connectivity functions.

ON/OFF key

It switches on and off the appliance and activates the control panel.

Control lock key

This key disables the control panel keys.

Fan key

 The fan activates and deactivates automatically depending on the software settings.

Through this button you can activate or deactivate the **manual ventilation** mode to increase humidity inside the wine cellar.



3 Use

3.1 Instructions



Improper use Risk of damage to the appliance







- Do not rest any weight or sit on the appliance door.
- Do not store inflammable, explosive or volatile substances.
- Organic compounds, acids and essential oils can corrode the seals and plastic surfaces if left in contact with them for extended periods.
- Do not obstruct the openings of the ventilation grille in any way.
- Bottles with a high alcohol content must be tightly closed.

3.2 Preliminary operations



1. Remove any protective film from the outside or inside of the appliance, including accessories.
2. Remove any labels (apart from the technical data plate) from the accessories and shelves.
3. Remove and wash all the appliance's accessories (see 4 Cleaning and maintenance).

3.3 First use

To turn on the appliance:

1. insert the plug into the power socket;
2. press the ON/OFF  key on the control panel;
3. press the **upper wine cellar temperature**  **12** key and select the required temperature for the interior of the upper wine cellar by pressing the **Increase**  or **Decrease**  keys (from 5°C to 20°C).
4. press the **lower wine cellar temperature key**  **12** and select the required temperature for the interior of the lower wine cellar by pressing the **Increase**  or **Decrease**  keys (from 5°C to 20°C).



Each press of the **Increase**  or **Decrease**  keys changes the temperature by 1°C.



The set temperature will flash on the display for around 5 seconds, and then it remains steadily displayed.

To turn off the appliance:

5. press and hold the ON/OFF  key on the control panel for a few seconds.







3.4 Using the control panel

Interior lighting



The interior lighting is provided by an LED light bar installed at the top of the wine cellar.

To activate and deactivate the interior lighting:

1. press the **ON/OFF**  key to activate the control panel.
2. press the **Light**  key. The symbol on the Light key will flash and the upper compartment lighting will turn on.
3. Press the **Light**  key. The upper compartment lighting will turn off and the lower compartment lighting will turn on.
4. Press the **Light**  key. The lower compartment lighting will remain on and the upper compartment lighting will turn on.
5. Press the **Light**  key. The symbol on the Light key will remain steadily lit and the lighting in both compartments will turn off.



Manually operated interior lighting will stay on for a maximum of 15 minutes.

- The lighting also comes on when the door is opened.



The internal lighting activated when the door is opened is brighter than the lighting activated via the **Light**  key.



Manual ventilation

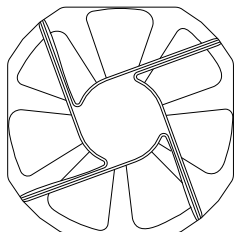



The fans switch on and off automatically to guarantee a constant temperature and provide suitable climate control for conservation of the wine.

To increase the level of humidity inside the wine cellar it is possible to activate and deactivate the manual ventilation mode. Once activated, the manual ventilation mode forces the continuous operation of the fan. If the manual ventilation mode is deactivated, the fan goes back to the standard operation managed by the electronics.

It is advisable to select this option from time to time in order to prevent corks from drying out when bottles are stored for long periods.

To activate manual ventilation:

1. press the **ON/OFF**  key to activate the control panel.
2. Press the **fan**  key. The symbol on the fan key will flash.

To deactivate manual ventilation:

3. Press the **fan**  key again.



If the door is opened, the fans will be deactivated. The fans then reactivate when the door is closed.

Connectivity

Connectivity requirements:

- Smartphone or PC tablet with IOS version 10.x or higher or Android version 5.1 or higher.
- Wi-Fi connection (2.4 GHz band, WPA2 security) active and available in the location where the device is installed.
- Internet connection.
- Name and password of the home Wi-Fi.



For further information, please read the **Connectivity Manual**.



Control lock

i This function prevents the appliance from being accidentally switched off. When active, the control panel will not react when any key is pressed.

To activate the control lock:

1. press the **ON/OFF**  key to activate the control panel.
2. Press and hold the **Control lock**  key for at least 3 seconds.







To deactivate the control lock:

3. Press and hold the **Control lock**  key for at least 3 seconds.





Demo mode (for showrooms only)

i Turns off the appliance's fans and compressor while keeping the control panel active.

To activate demo mode:

1. press the **ON/OFF**  key to activate the control panel.
2. Press and hold the **fan**  and **control lock**  keys simultaneously for around five seconds. The text  will appear on the display.
3. Press the **fan**  key. The text  will appear on the display.

To deactivate demo mode:

4. Press and hold the **fan**  and **control lock**  keys simultaneously for around five seconds. The text  will appear on the display.
5. Press the **fan**  key. The text  will appear on the display.

i When demo mode is active, the display will show the message  for 2 seconds every 2 minutes.



Use

3.5 Using the wine cellar compartments

Bottle arrangement

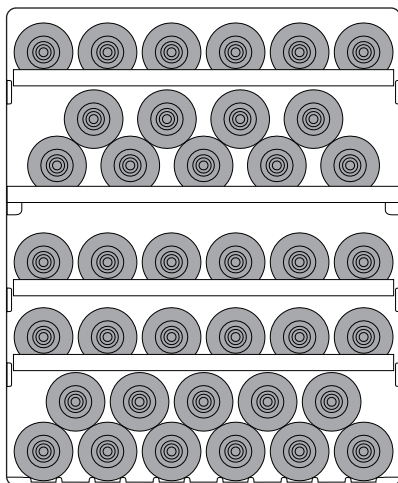

(max 38 bottles)

Each removable shelf can hold up to 6 standard 0.75 litre wine bottles.

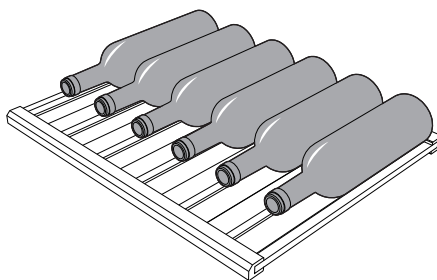

The fixed shelf can hold up to 9 standard 0.75 litre wine bottles, but it can also accommodate up to 5 champagne/sparkling wine type bottles (or in any case bottles with a greater than normal diameter).

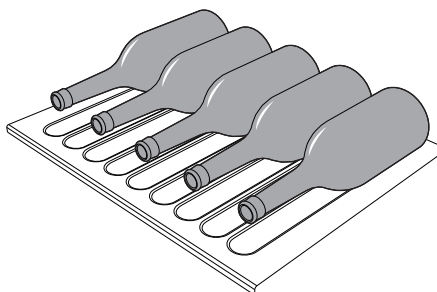



Up to 11 x 0.75 litre bottles can also be placed on the base of the wine cellar.

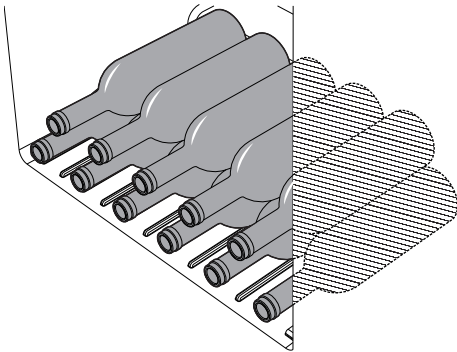

Improper use
Damage and injury hazard

- Do not place bottles sideways on the base of the wine cellar. They could fall when the door is opened.

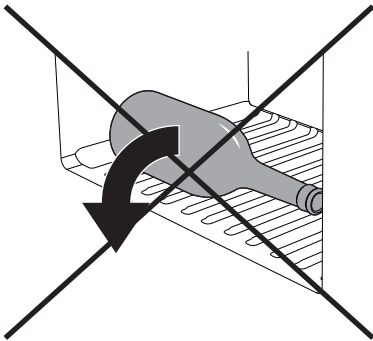

Activated charcoal filter



To maintain optimum air quality inside the wine cellar, the activated charcoal filter must be replaced at least once a year.

To replace the activated charcoal filter:

1. Turn the filter cap 90° to the left or right.

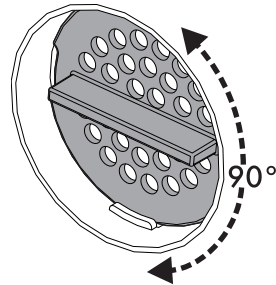

2. Extract the cap from its seat.

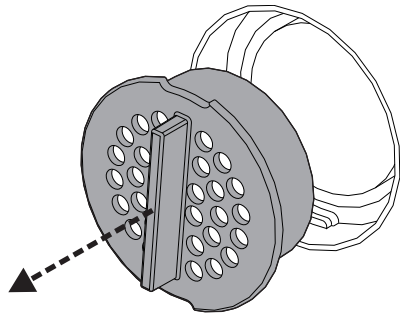

3. Replace the activated charcoal filter with a new one.
4. Replace the filter cap following the indications in points 1 and 2.



Replacement filters can be ordered from Authorised Service Centres.



Noises during operation

The wine cellar is cooled by means of a compression system. In order to maintain the preset temperature inside the wine cellar, the compressor comes into operation in response to the level of cooling required, and may operate continuously if necessary. When the compressor starts to function, it creates a buzzing noise which generally diminishes in intensity after a few minutes.

Another normal wine cellar operating noise is a gurgling due to the refrigerant flowing through the pipes in the circuit. This noise is normal and does not indicate an appliance malfunction.

Turning the appliance off

Whenever the appliance is to remain unused for long periods, it should be switched off.

1. Press and hold the **ON/OFF**  key on the control panel for a few seconds until the appliance turns off.
2. Unplug the appliance from the wall socket.
3. Empty the wine cellar.
4. Dry any residual moisture which has accumulated with a soft cloth.
5. Leave the door ajar to prevent the humidity and trapped air from creating unpleasant smells.

3.6 Alarms



The alarms help protect the wine from temperatures which could compromise its quality.

Each alarm consists of a message flashing on the display, and an audible warning.

The display continues to flash until the alarm condition finishes.

- To deactivate the alarm, press the display button of the upper compartment .

Temperature alarm

The temperature on the display may start to flash. This means that the temperature inside the wine cellar compartment is too high or too low in relation to that set.

This may occur:

- when the appliance is first turned on;
- if a temperature much higher or much lower than the previous one is set;
- if the wine cellar is loaded with many bottles at ambient temperature;
- in the event of an extended interruption in mains voltage.



These conditions may occur during normal operations of the appliance and are not caused by problems/faults.

In this case, deactivate the alarm through any key on the control panel and wait for the temperature to return within the normal storage values. It may be necessary to repeat this operation 1–2 times.



If the alarm continues to occur, call Technical Support.

Alarm for door open

The left display shows: **ES** the door has been left open for more than 60 seconds

- Close the door.



The alarm will reactivate in the same way 60 seconds after it is shut off if the door is still open.

Fault alarms

The left display shows from **E1** to **E9** (**ES** excluded) or **EA** or **EC** or **EE** or **EF**: appliance fault.

- Switch off the appliance and call Technical Support.

Connectivity alarms

The display shows **EE**: appliance failure.

The APP shows **EF**: appliance failure.

- Call Technical Support.

For further information, please read the **Connectivity Manual**.



In case of alarm **EE** the appliance continues cooling wines.

3.7 Food storage advice

White wines

White wines are generally more acidic than reds and contain less tannin. To be enjoyed at its best, an acidic drink should usually be stored at a slightly lower temperature than other types, and so these wines should be stored at a temperature between 10°C and 14°C.

Young, fresh, aromatic white wines can be served at a temperature as low as 10°C, while for less aromatic wines 12°C is recommended. For full, mature white wines which have aged in the bottle for a few years, higher temperatures are acceptable and they can be served at between 12°C and 14°C.

Serving a white wine at a higher temperature means emphasising its “sweet” properties, while the acidity and sharpness considered pleasant and desirable in wines of this kind will be less noticeable.



Rosé wines

Generally, the rules for serving rosé wines are the same as for whites. However, it is important to consider these wines' tannin content and serve them at a higher temperature if necessary so that their flavour is not too sharp. Tannin content permitting, young, fresh rosé wines are served between 10°C and 12°C, while more robust, full-bodied types, including more mature wines, can be served between 12°C and 14°C.

Red wines

The serving temperature for red wines depends on a great deal of factors, but in view of their higher tannin and lower acidity than whites, they are usually served at higher temperatures. Young red wines with low tannin are usually served between 14° and 16°C, while for more full-bodied types 16°C or in exceptional cases even 18°C may be recommended.

Young red wines high in tannins and with a fairly uncomplicated structure can be served at between 12°C and 14°C without tasting too sharp, and will still be very pleasant. This rule applies to "nouveau" wines, made by a special method which reduces their tannin content; they can be appreciated to the full at cooler temperatures than other red wines.

Sparkling wines

In view of the large number of types of sparkling wines on the market, there would be little sense in laying down one rule to fit them all. Sweet, aromatic white sparkling wines can be served at a temperature as low as 8°C. Their aromatic nature means they are excellent at low temperatures.

Sweet red sparkling wines such as Brachetto may be served at temperatures between 10°C and 12°C. Here again, the more aromatic sparkling wines are suitable for lower temperatures, even down to 8°C, while those with a slightly higher tannin content require temperatures as high as 14°C.

Dry sparkling wines made by the "Charmat method" or "Martinotti method", such as some Prosecco wines, can be served at temperatures between 8°C and 10°C.

Sparkling wines made by the "traditional method" and the "méthode Champenoise", such as Champagne, require special consideration: in general these sparkling wines are served at temperatures between 8°C and 10°C. However, for prestige wines marked with the vintage, or sparkling wines that have been aged for a long time, even 12°C may be advisable to allow the development of the complex bouquet that has been slowly and painstakingly built up over the years.



Dessert wines and fortified wines

These two types of wine generally both contain a high alcohol percentage and they are both often also sweet. However, there are dry dessert wines, such as Marsala, with a sugar content so low as to be almost imperceptible on the palate. For these wines, the serving temperature depends on which features you wish to emphasise. If you prefer to accentuate the wine's sweetness, the complexity of its bouquet and its austerity, it should be served at a high temperature, between 14°C and 18°C. Remember that in this case its alcohol content will also be more in evidence.

If you require a fresher sensation, or to reduce the sweetness of over-sweet wines, serve at a lower temperature, between 10°C and 14°C.

Young, fresh, dry dessert wines can be served at colder temperatures, below 10°C. This makes the alcohol content considerably less noticeable. However, remember that as the temperature is reduced the bouquet also becomes less evident. One of these wines' key characteristics is the charm and complexity of their bouquet; serving them too cold also means sacrificing this important feature.

Storage temperatures

To enjoy the flavour and bouquet of each wine at its best, it should be stored and drunk at a specific temperature. The recommended temperatures for different kinds of wines are given below.

Type of wine	Temperature
Young whites	10°C - 12°C
Mature whites	12°C - 14°C
Young, light rosés	10°C - 12°C
Mature, full-bodied rosés	12°C - 14°C
Nouveau reds	10°C - 14°C
Young, light reds with low tannin	14°C - 16°C
Mature, full-bodied reds with high tannin	16°C - 18°C
Very mature and cask-aged reds	16°C - 18°C
Sweet and aromatic sparkling wines	8°C
Sweet and aromatic red sparkling wines	10°C - 12°C
"Charmat method" sparkling wines	8°C - 10°C
"Long Charmat method" sparkling wines	10°C - 12°C
"Traditional method" sparkling wines without year	8°C - 10°C
"Traditional method" sparkling wines with year	10°C - 12°C
Dessert wines	10°C - 18°C
Fortified or liqueur wines	10°C - 18°C



4 Cleaning and maintenance

4.1 Instructions



Improper use

Risk of damage to surfaces

- Do not use steam jets to clean the appliance.
- Do not use cleaning products containing chlorine, ammonia or bleach on parts made of steel or that have metallic surface finishes (e.g. anodizing, nickel- or chromium-plating).
- Do not use abrasive or corrosive detergents (e.g. scouring powders, stain removers and metallic sponges) on glass parts.
- Do not use rough or abrasive materials or sharp metal scrapers.



Power voltage

Danger of electrocution

- Turn off the appliance and unplug it from the mains before cleaning.
- Do not pull the cable to remove the plug.

4.2 Cleaning the appliance

A special antibacterial protection on the appliance's interior walls prevents bacterial growth and keeps them clean. They must nevertheless be cleaned regularly in order to keep them in good condition.

Cleaning the outside of the appliance

- The appliance may be cleaned with water or alcohol-based liquid detergents (e.g. window cleaning products).
- Avoid aggressive detergents and rough sponges in order not to damage the surfaces.

Cleaning the inside of the appliance

- Clean the inside of the appliance with diluted liquid detergent and warm water, adding a little bit of vinegar.

Cleaning the removable shelves

- Use a soft, damp cloth to clean the removable shelves. Avoid the use of soaps and detergents and/or sponges which could damage both the wooden and steel surfaces.

Removing the removable shelves

The removable shelves can be extracted from the interior of the wine cellar to facilitate cleaning.



To extract the removable shelves

1. Open the door.
2. Extract one of the shelves.

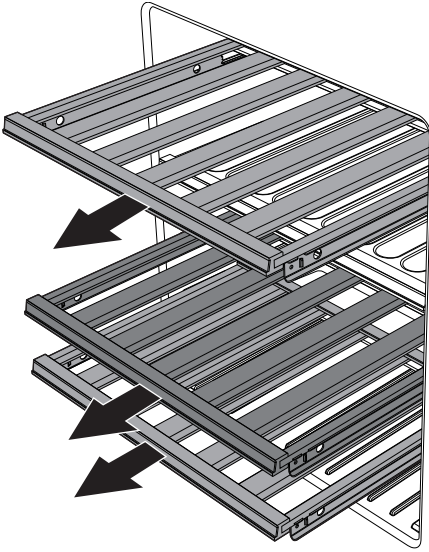

3. Lift the shelf removed upwards.

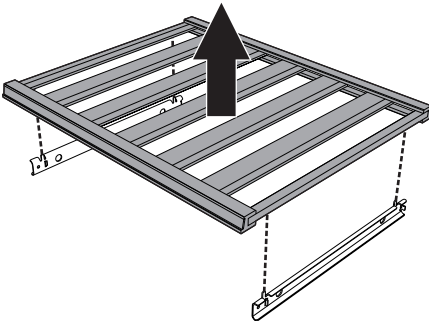

4. Repeat the operation for the other shelves.

To refit the removable shelves

1. Line up the shelf with the four pins of the guide and rest it on this.

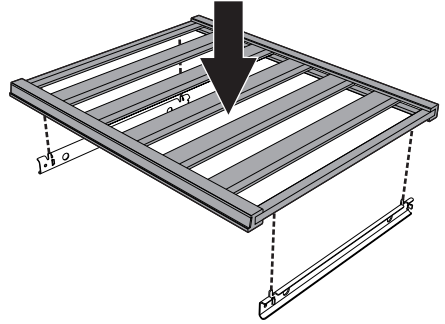

2. Push the shelf inside the wine cellar.

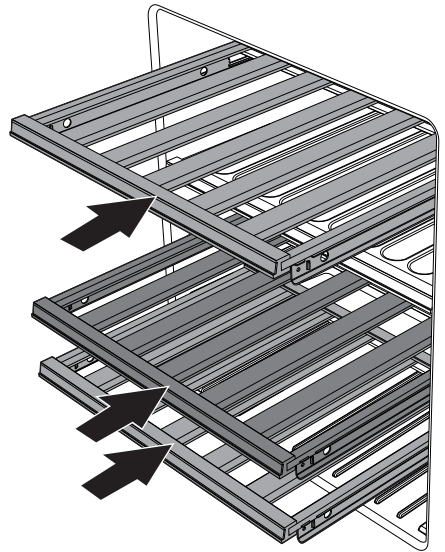

3. Repeat the operation for the other shelves.
4. Close the door.



Cleaning and maintenance

4.3 What to do if...

The appliance does not work:

- Make sure that the appliance is plugged in and that the main switch is turned on.

The compressor starts to function too often or functions continuously:

- The room temperature is too high.
- The door is being opened too often or for too long.
- The door is not closing/sealing properly.
- There is an excessive quantity of warm bottles.
- Check that the back of the freezer is properly ventilated and that the condenser is not too dirty.

There is excessive condensate build-up inside the wine cellar:

- The door is being opened too often or for too long.
- Warm bottles have been placed inside the wine cellar.
- The door seal is damaged or dirty.
Clean or replace it.

Water builds up inside the wine cellar:

- The drainage channel or opening is blocked.

The wine cellar cooling is insufficient:

- The temperature set on the display is too high.
- The door is being opened too often or for too long.
- The door is not closing/sealing properly.
- The room temperature is too high.



5 Installation

5.1 Electrical connection



Power voltage
Danger of electrocution

- The appliance must be connected to ground in compliance with electrical system safety standards.
- Do not pull the cable to remove the plug.

General information

- Check the mains characteristics against the data indicated on the plate. The identification plate bearing the technical data, serial number and brand name is visibly positioned inside the appliance. Do not remove this plate for any reason.
- Make sure that the plug and socket are of the same type.
- Avoid using adapters, gang sockets or extensions as these could cause overheating and a risk of burns.
- The plug must always be accessible when the appliance is installed.
- Leave the appliance standing vertically for at least two hours before turning it on for the first time.
- If it is necessary to replace the power cable, **this must be performed by an authorised technician from Technical Support Service.**

5.2 Positioning



Heavy appliance
Crushing hazard

- Position the appliance with the aid of a second person.



Pressure on the open door
Risk of damage to the appliance

- Never use the open door to lever the appliance into place when fitting.
- Avoid exerting too much pressure on the door when open.
- The appliance must not be exposed to direct sunlight.
- The appliance must not be installed near heat sources. If this is not possible, suitable insulation must be used.
- Do not use the appliance outdoors.

Choice of location

Always install the appliance in a dry place with satisfactory ventilation. Depending on its climate class (stated on the nameplate inside), the wine cellar can be used in different temperature conditions.



Installation

Class	Room temperature
SN	+ 10°C to + 32°C
N	+ 16°C to + 32°C
ST	+ 16°C to + 38°C
T	+ 16°C to + 43°C
SN-ST	+ 10°C to + 38°C
SN-T	+ 10°C to + 43°C

SN = Subnormal - N = Normal

ST = Subtropical - T = Tropical

- Install the appliance at least 3 cm away from electrical or gas cookers and at least 30 cm away from combustion heaters or radiators.
- The appliance must not be installed near heat sources. If this is not possible, suitable insulation must be used.
- Ensure that the appliance is located with sufficient space for the door to open and for the internal drawers and shelves to be removed, if necessary.
- To ensure correct cooling of the condenser, respect the clearance requirements when mounting.

Appliance overall dimensions (mm)

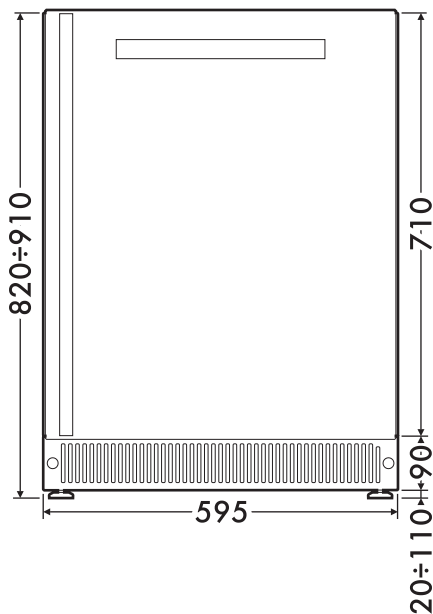

(front view)

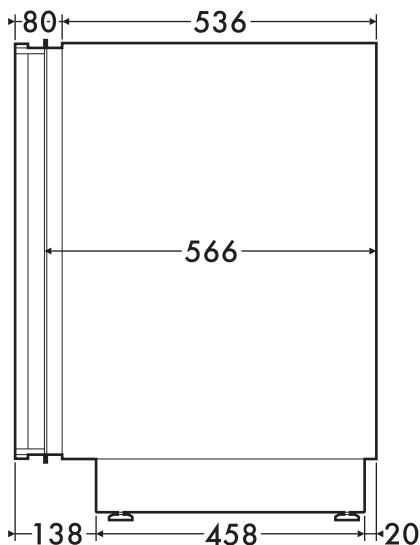

(side view)

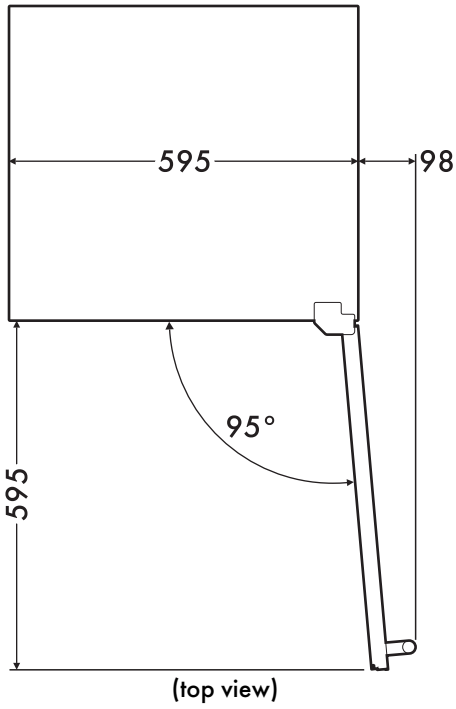

Mounting (mm)

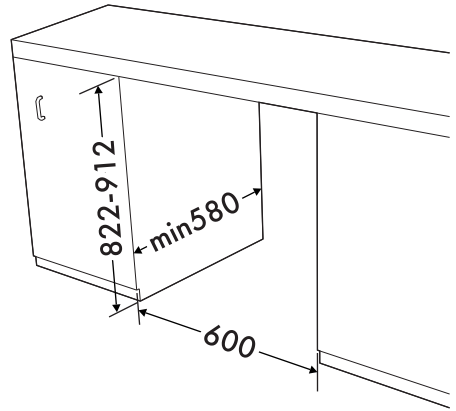

EN



Do not cover the ventilation holes.



Installation

Positioning

Position the appliance on a firm, level surface. Use the four adjustable feet to compensate for any irregularities in the floor (use a CH17 spanner).

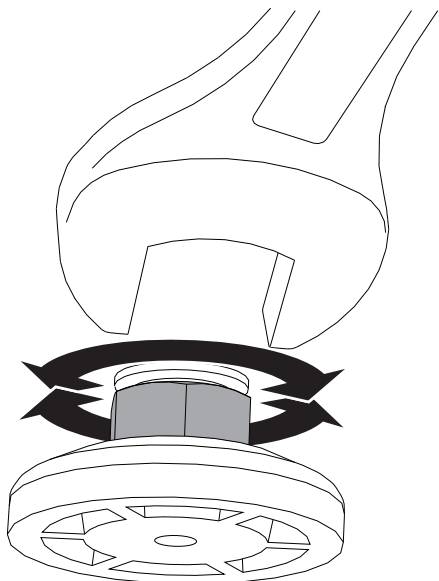

Take great care when moving the appliance, in order not to damage flooring by sliding it (for example with wood flooring).

Fastening trim bar

The appliance is fitted with a (removable) fastening trim bar to fasten it below the kitchen worktop.

To fasten the appliance to a kitchen worktop:

1. Open the door.
2. Use the 4 screws supplied to fasten the appliance.

