

组件

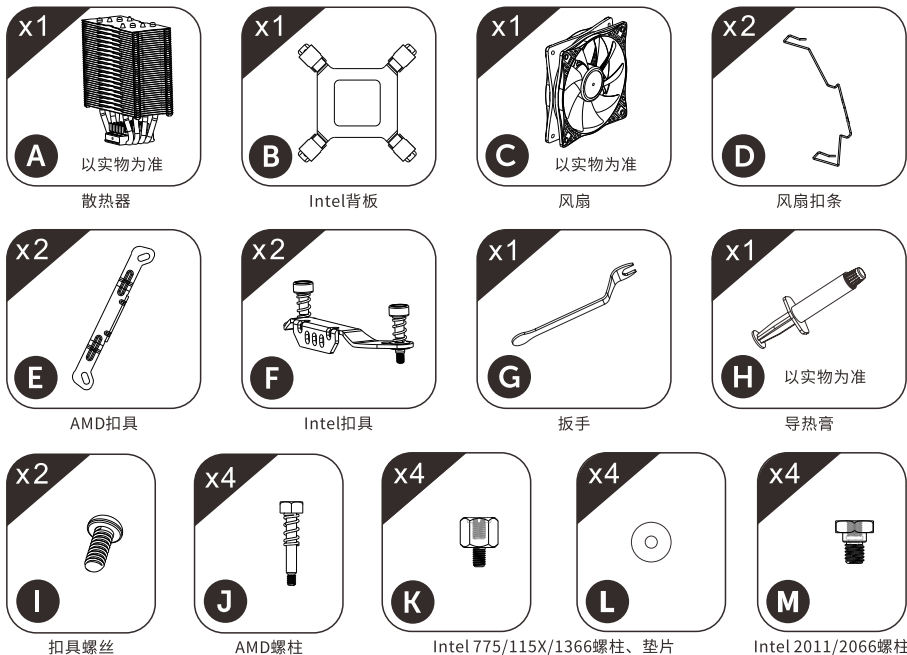

AMD安装步骤

步骤一：将导热膏均匀涂抹在CPU上

步骤二：将散热器安装在主板上：

- 1、安装扣具；
- 2、散热器固定在主板上；
- 3、风扇安装在散热器上；
- 4、检查散热器安装是否稳固。

⚠ 请注意分清CPU平台孔位

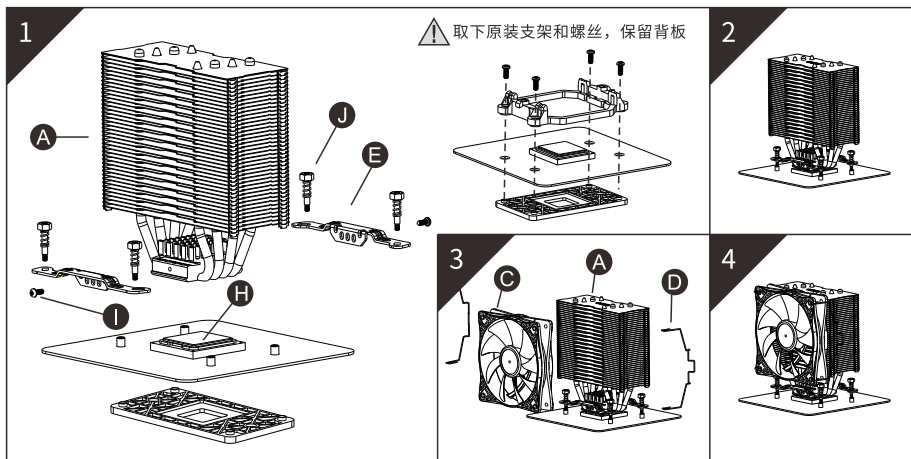
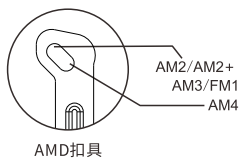

INTEL安装步骤

步骤一：调整扣具螺丝至相应主板平台位置

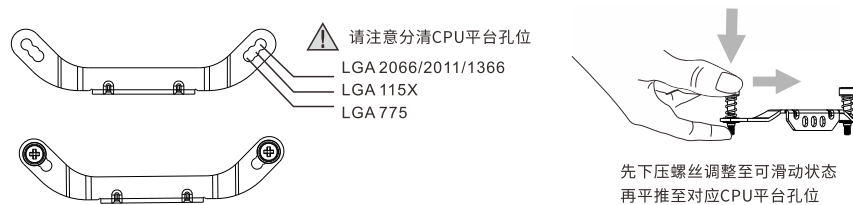

步骤二：将导热膏均匀涂抹在CPU上

步骤三：将散热器安装在主板上：

- 1、安装扣具；
- 2、散热器固定在主板上；
- 3、风扇安装在散热器上；
- 4、检查散热器安装是否稳固。

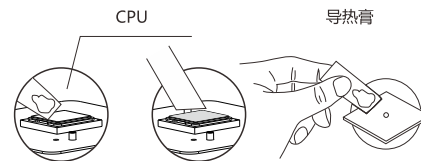



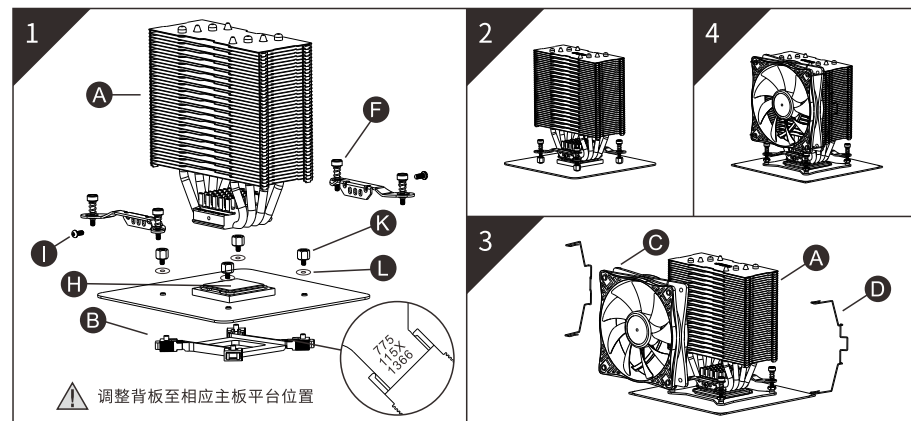



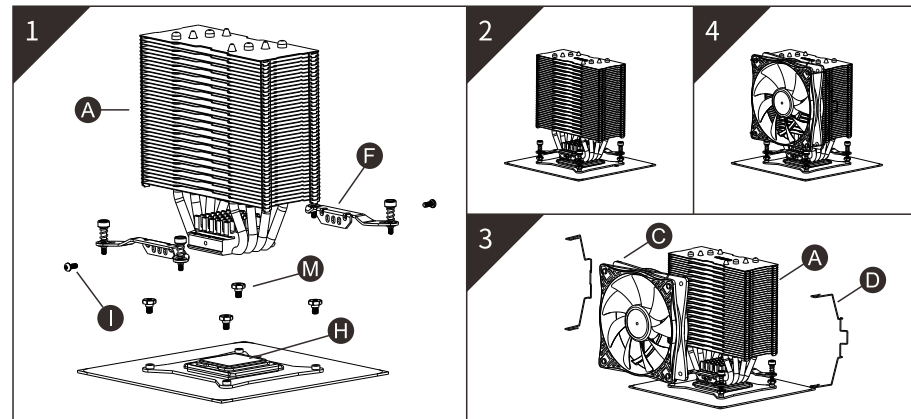

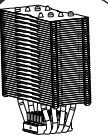
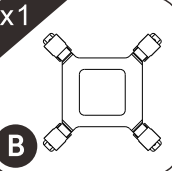
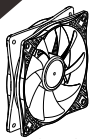

LGA 775/115X/1366 安装示意图

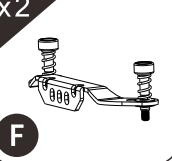

LGA 2011/2066 安装示意图



COMPONENTS

<b>x1</b> <b>A</b>  Heat Sink <small>based on real products</small>	<b>x1</b> <b>B</b>  Intel Back Plate	<b>x1</b> <b>C</b>  Fan <small>based on real products</small>	<b>x2</b> <b>D</b>  Fan Clip
<b>x2</b> <b>E</b>  AMD Bracket	<b>x2</b> <b>F</b>  Intel Bracket	<b>x1</b> <b>G</b>  Wrench	<b>x1</b> <b>H</b>  Thermal Grease <small>based on real products</small>
<b>x2</b> <b>I</b>  Bracket Holding Screw	<b>x4</b> <b>J</b>  AMD AM4/AM3 Holding Screw	<b>x4</b> <b>K</b>  Intel 775/115x/1366 Holding Screw	<b>x4</b> <b>L</b>  Intel 775/115x/1366 Gasket
	<b>x4</b> <b>M</b>  Intel LGA2011/2066 Holding Screw		

AMD Platform Installation Steps

**Step 1:** Apply Thermal Grease on CPU evenly

**Step 2:** Install the Heat Sink on the MB:

1. Bracket Setup;
2. Install the Heat Sink on the MB tightly;
3. Installing the Fan on the Heat Sinks;
4. Check whether the Heat Sinks is stable installed.

⚠ Make sure the correct hole positions of each platform

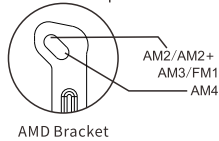

INTEL Platform Installation Steps

**Step 1:** Adjust the bracket Screws to the Right Positions

⚠ Make sure the correct hole positions of each platform

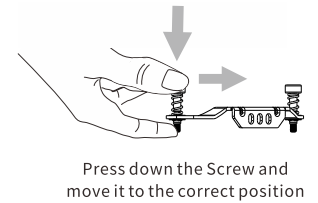
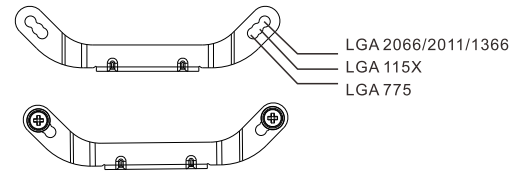

**Step 2:** Apply Thermal Grease on CPU evenly

**Step 3:** Install the Heat Sink on the MB:

1. Bracket Setup;
2. Install the Heat Sink on the MB tightly;
3. Installing the Fan on the Heat Sinks;
4. Check whether the Heat Sinks is stable installed.

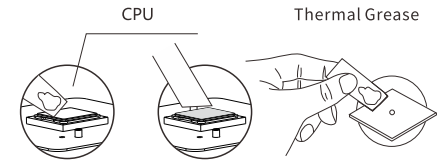

LGA 775/115X/1366 Installation Guide

LGA 2011/2066 Installation Guide