

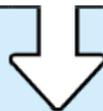

**SUPER
MARIO**™

71387

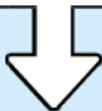

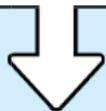
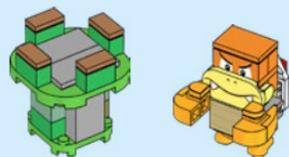
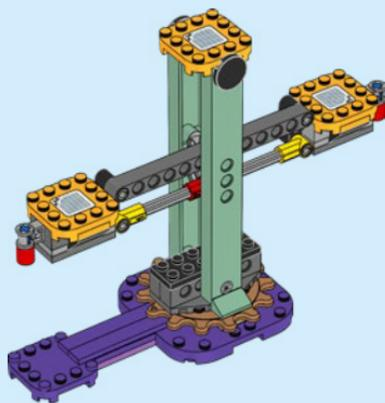

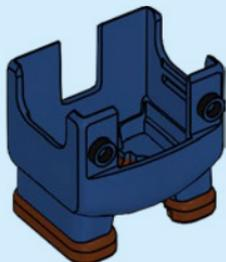
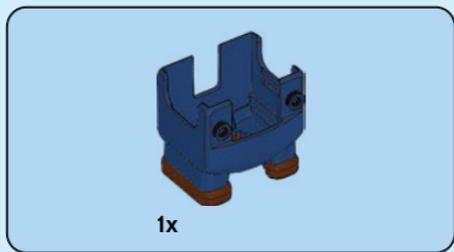
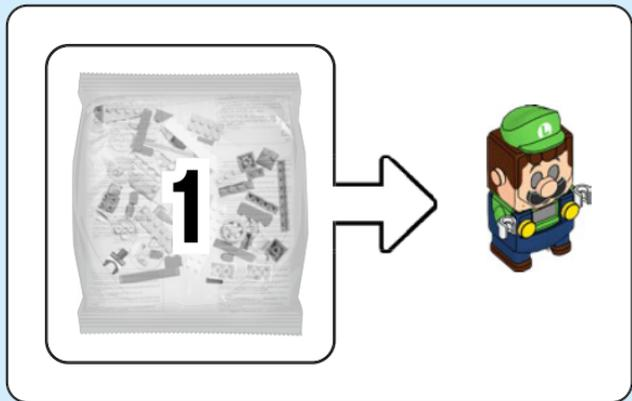

2





2x



2x

3

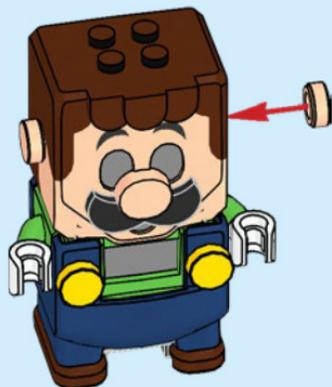

1x

4



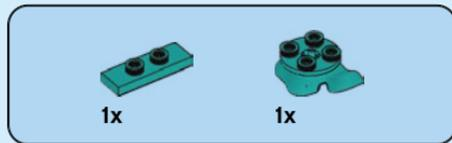
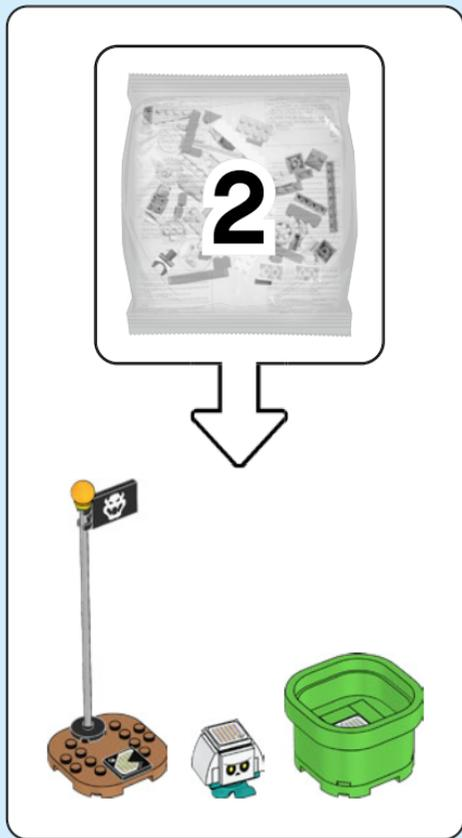

1

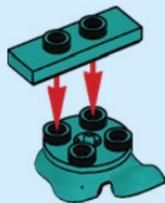



1x

2

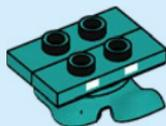

2x

3



1x

4





1x



1x

5

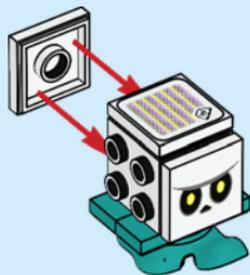

2x

6

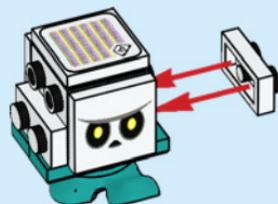

2x

7



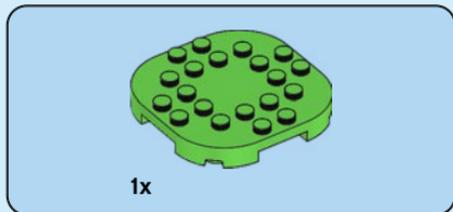

1

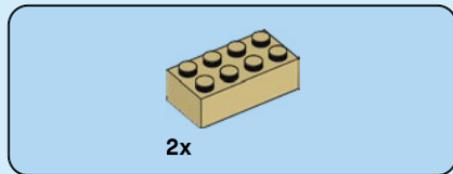
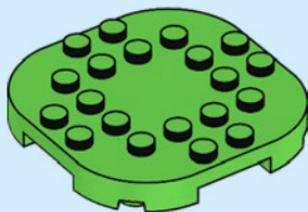

2

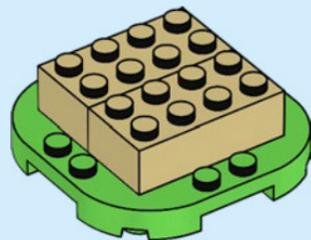

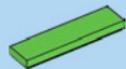

2x

3

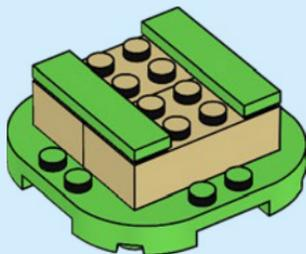

2x



1x

4

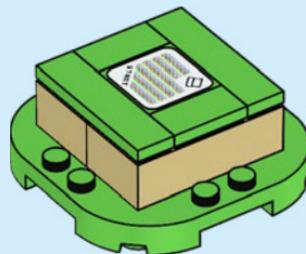

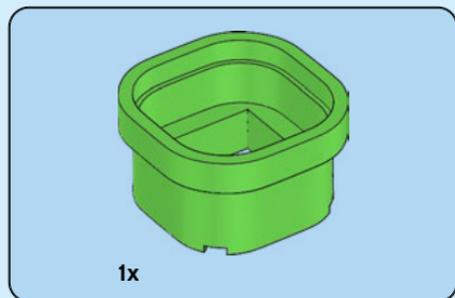

5

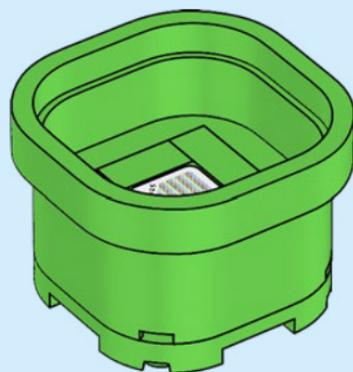

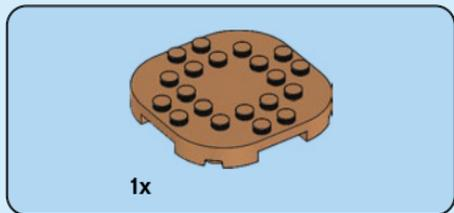

1

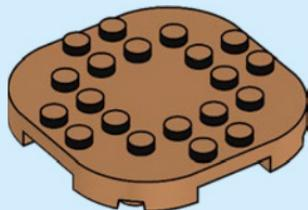

12

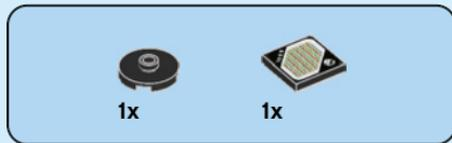

2

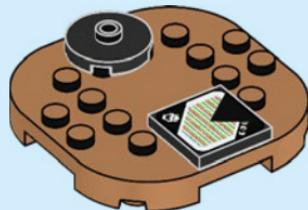

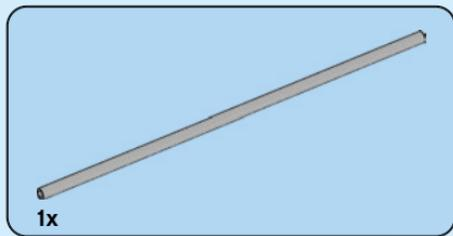

3

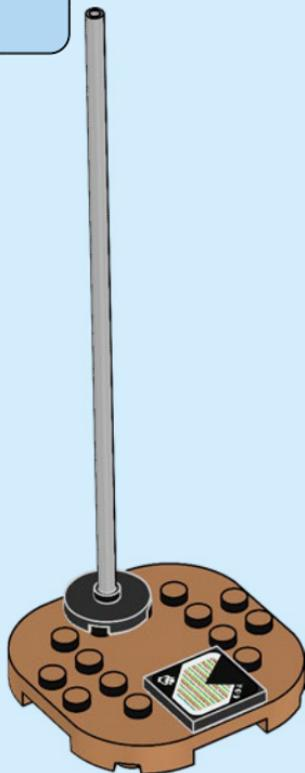

4

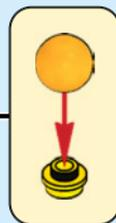
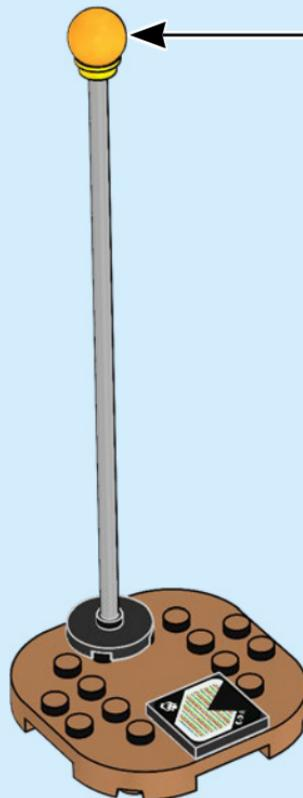



1x

5

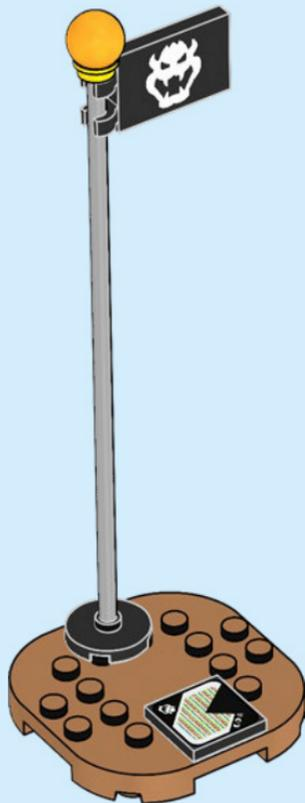

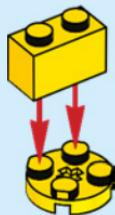
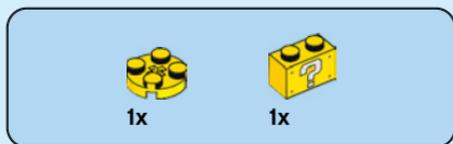
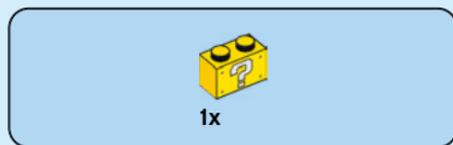
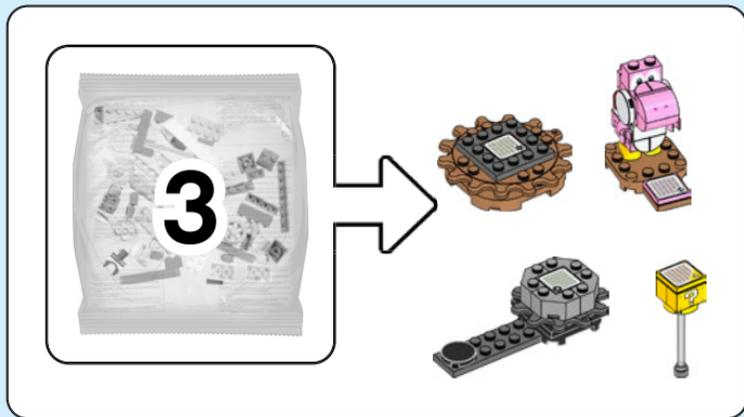



1x

3



1x

4



16



1x

5

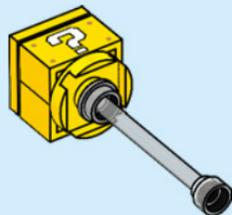

6



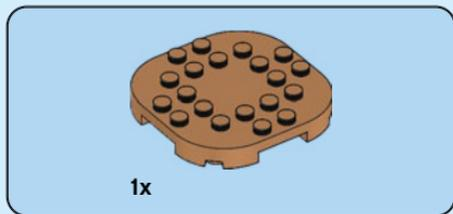

1

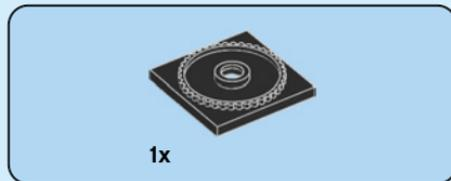
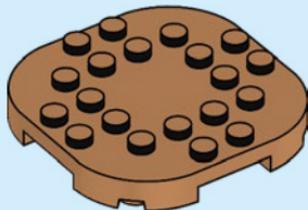

2



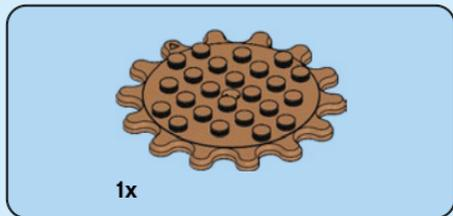

3

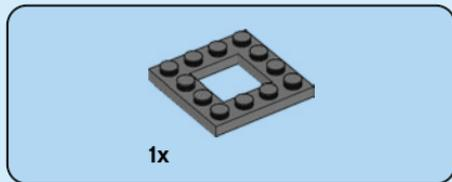
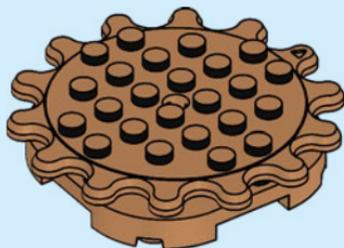

4

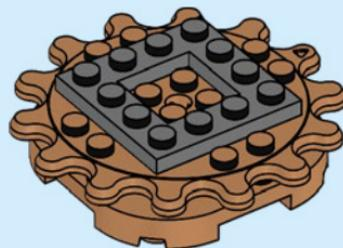



1x

5



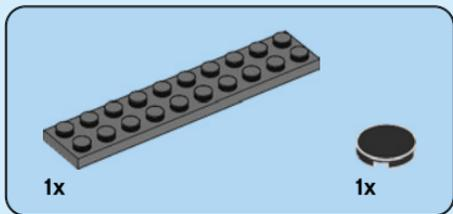

1

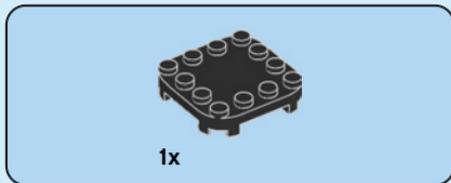
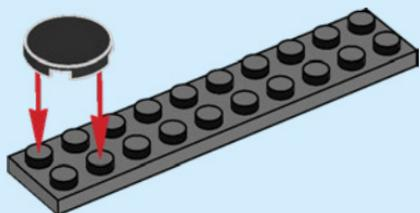

1x

2

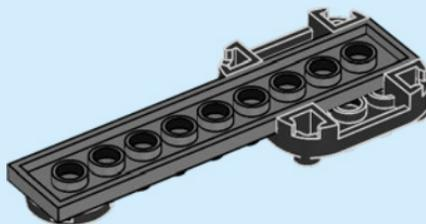

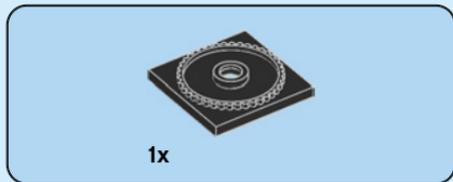

3

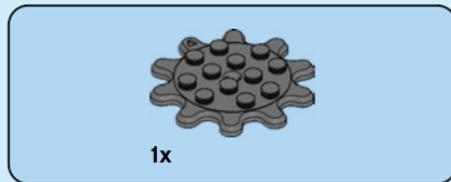
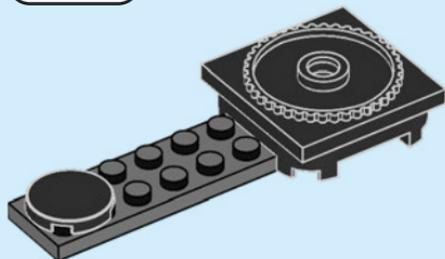

4

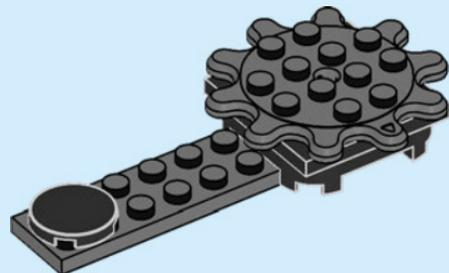



2x

5

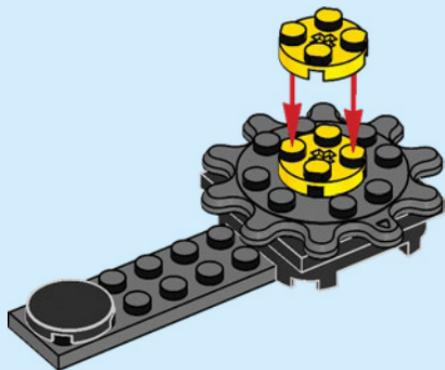

4x

6

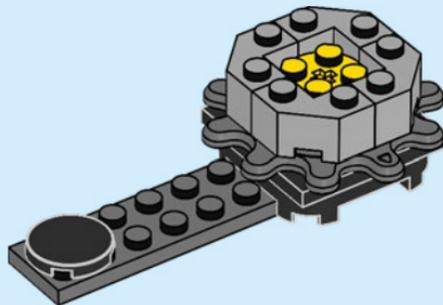

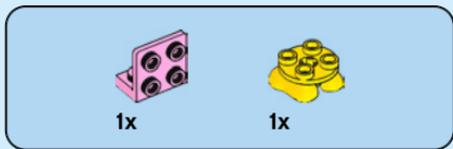

1

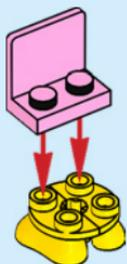

2

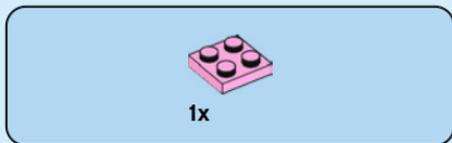

3

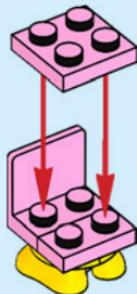



4

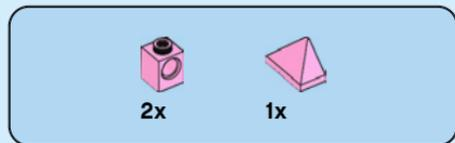

5

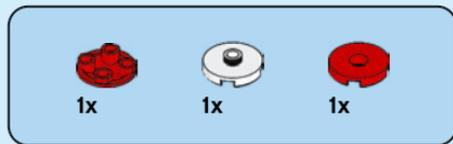
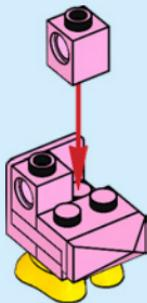

6

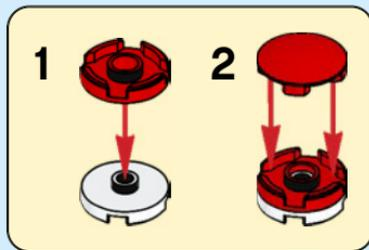



1x



2x

7



2x

8



1x

9

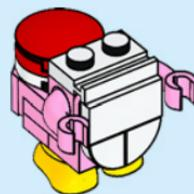

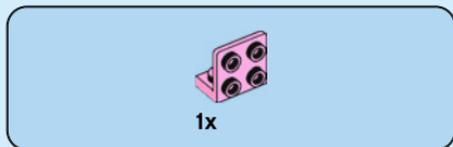

10

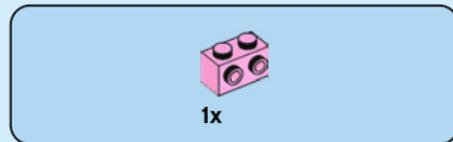

11

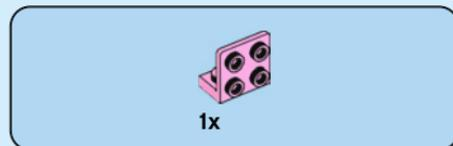

12





1x

13



2x

14

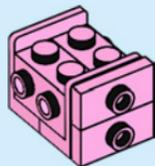

2x

15

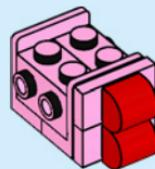

2x

16





1x

17

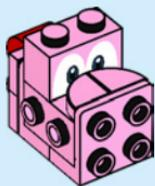

1x



1x

18

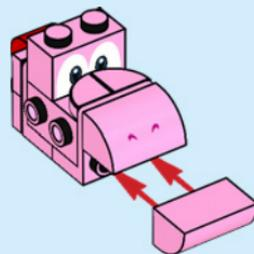

19

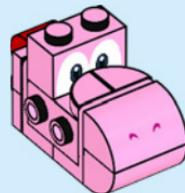

20

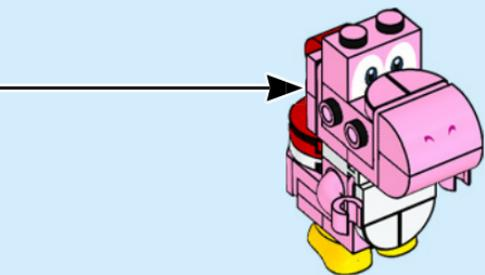

30



21

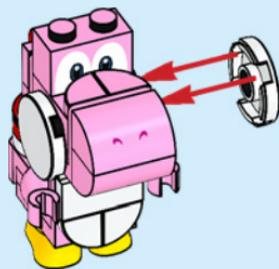

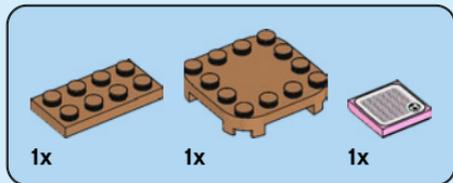

22

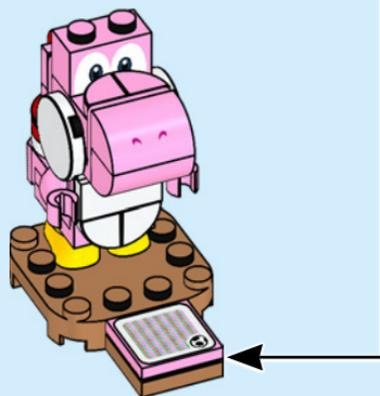
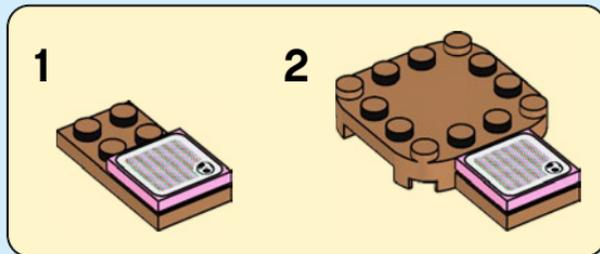

4

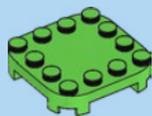
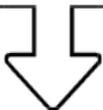

1x

1

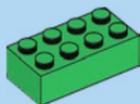
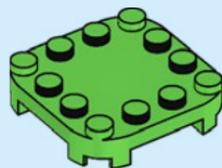

1x

2

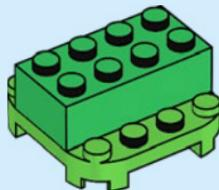



2x

3

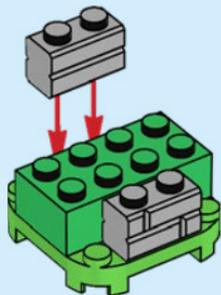

1x

4

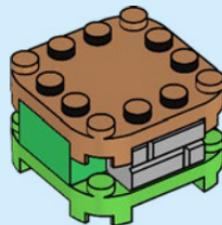

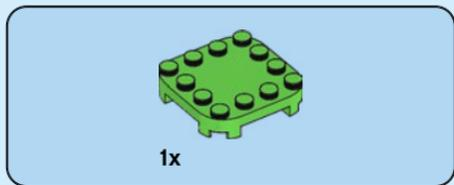

1

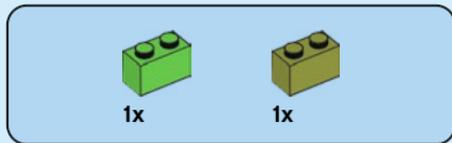
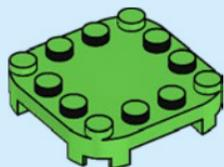

2

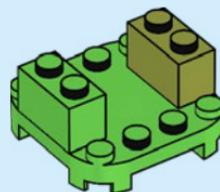

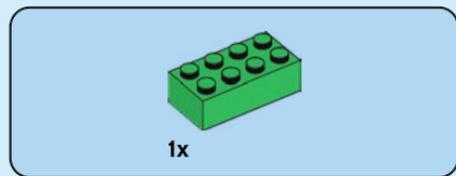

3

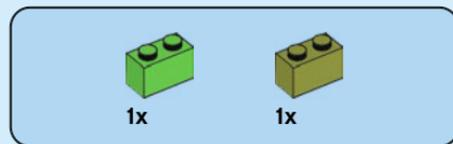
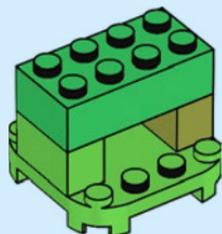

4

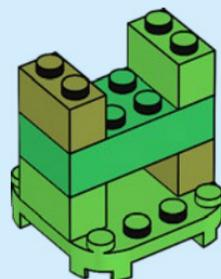

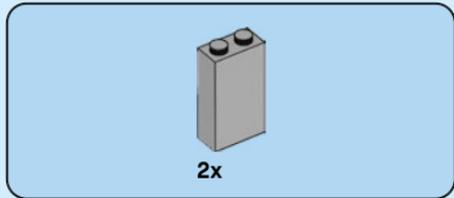

5

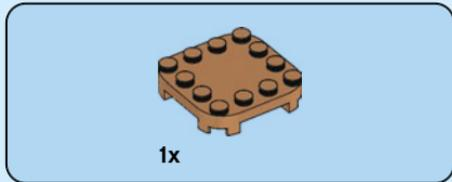
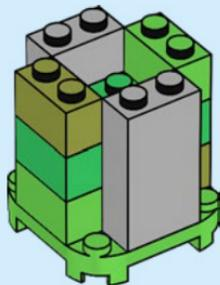

6

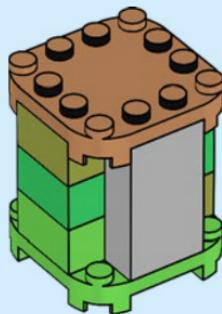

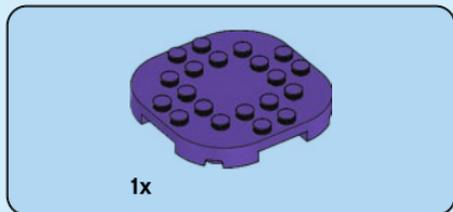

1

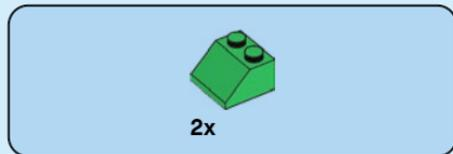
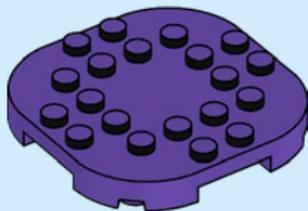

2

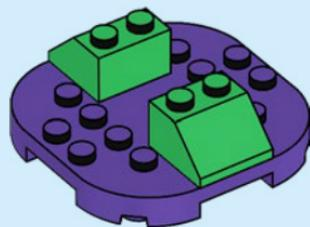

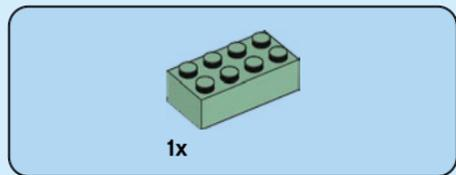

3

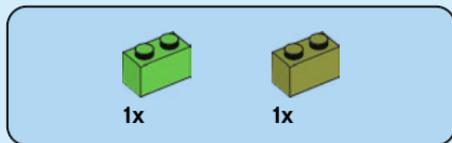
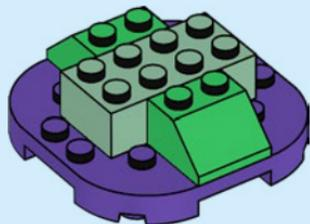

4

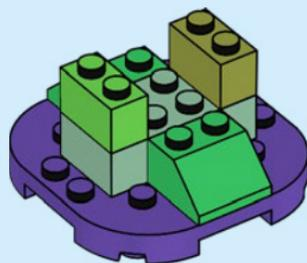

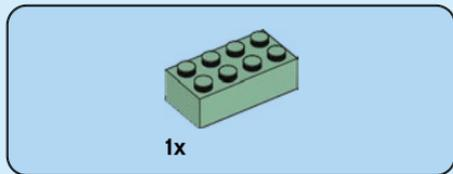

5

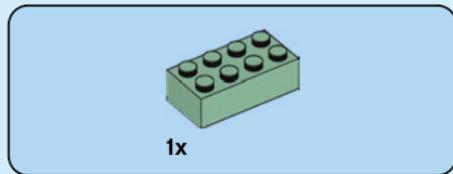
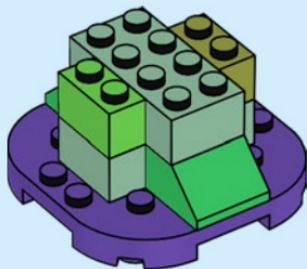

6

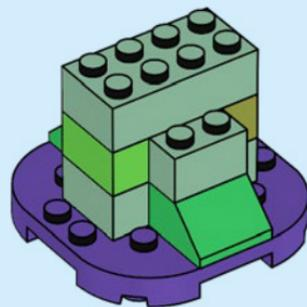



2x

7

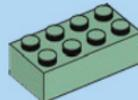
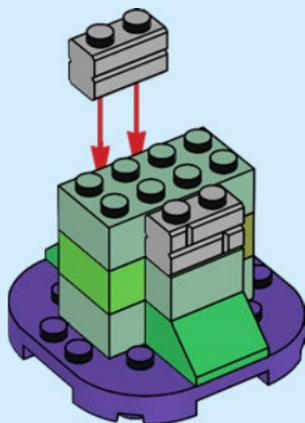

1x

8

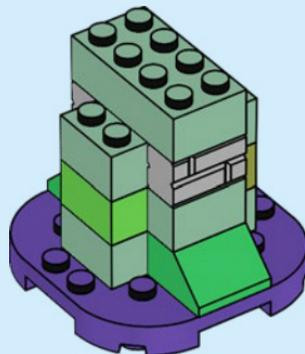



1x



1x

9

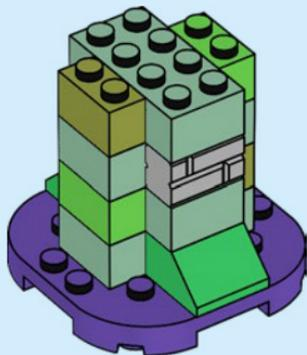

1x



1x

10

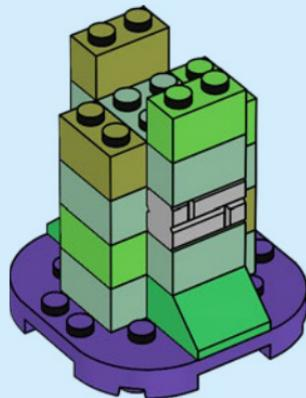

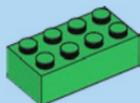

1x

11

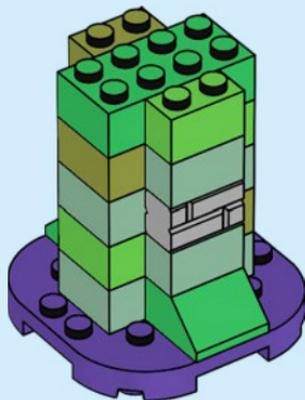

42



1x

12

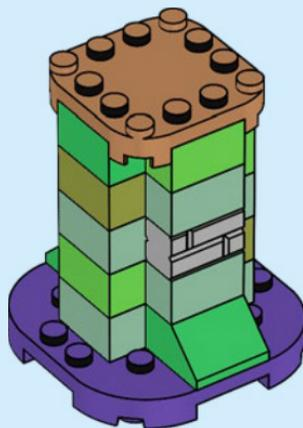

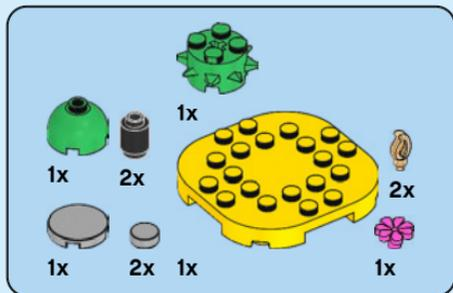

1

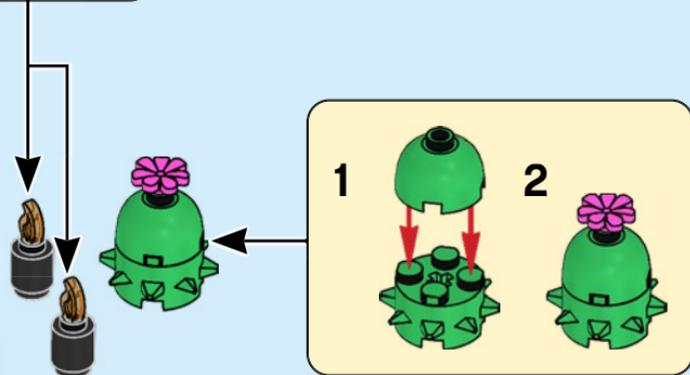
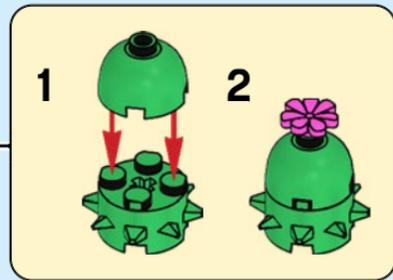
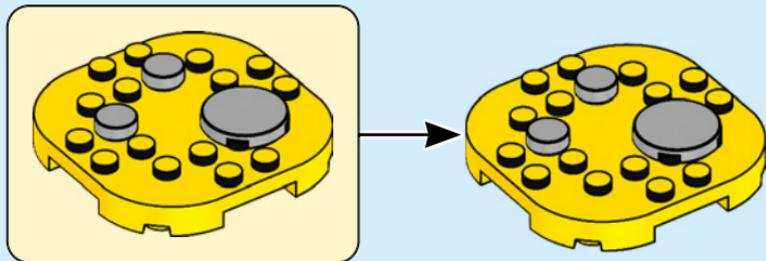
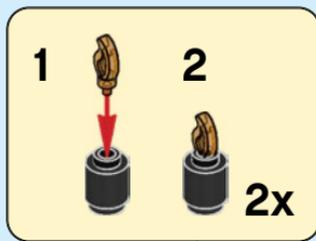

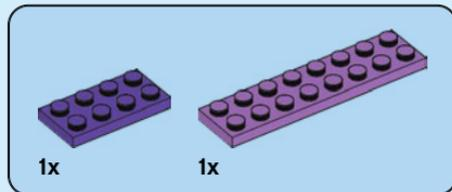
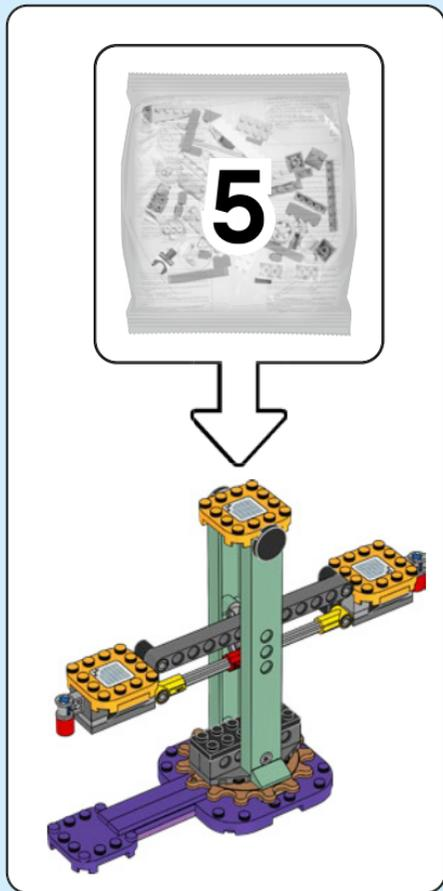

1

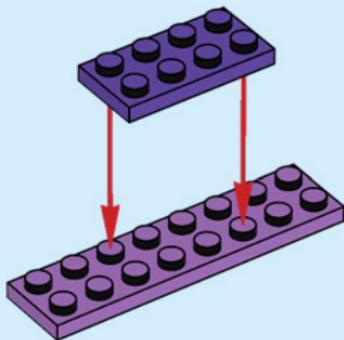

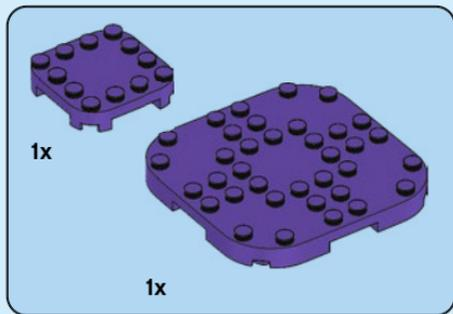

2

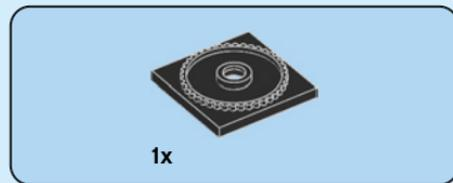
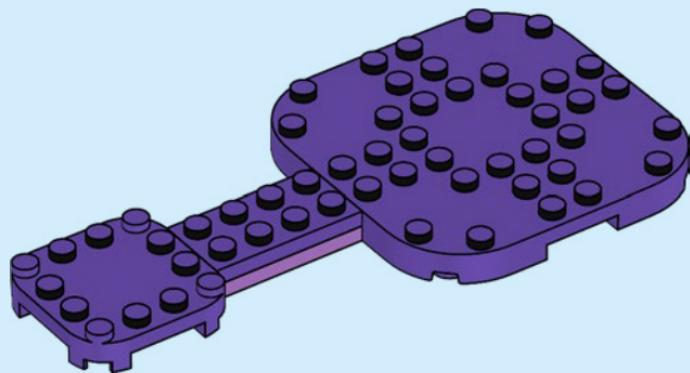

3

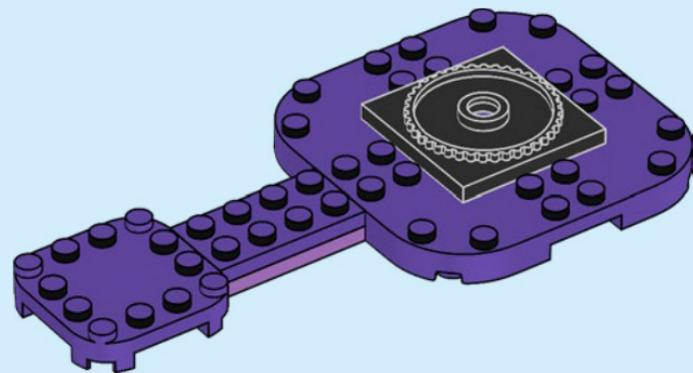

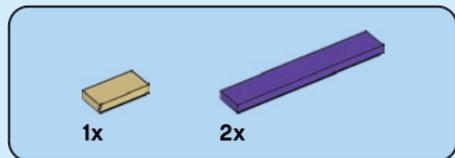

4

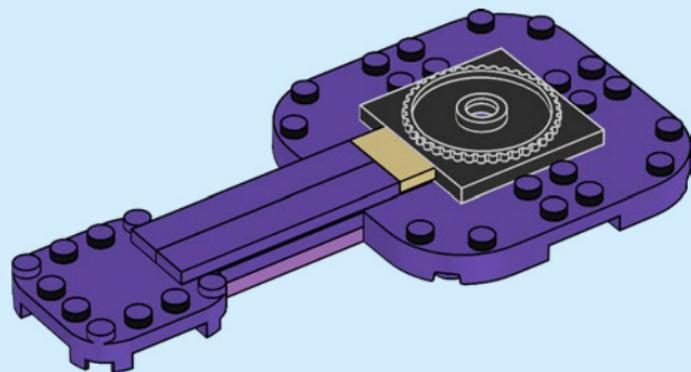

5

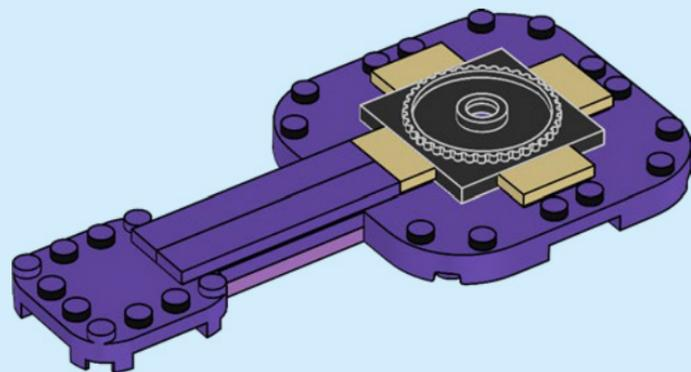

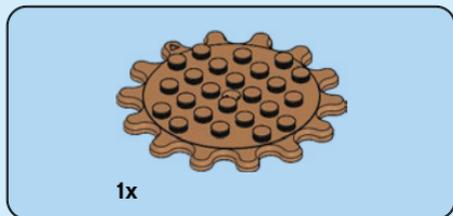

6

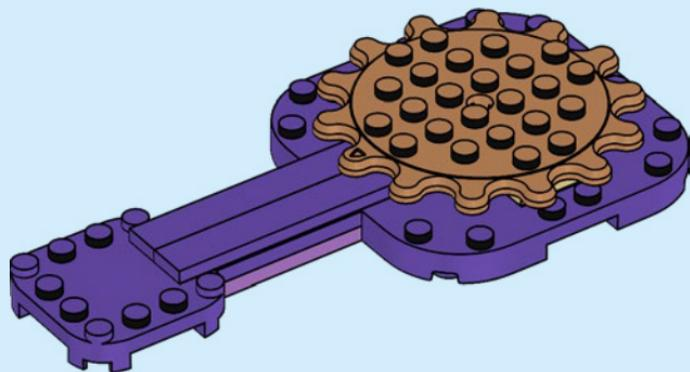

7

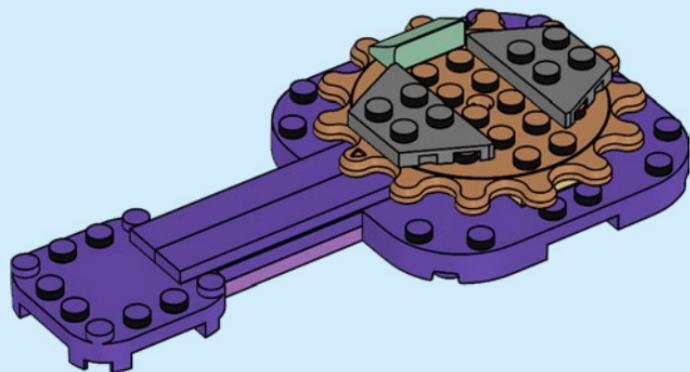

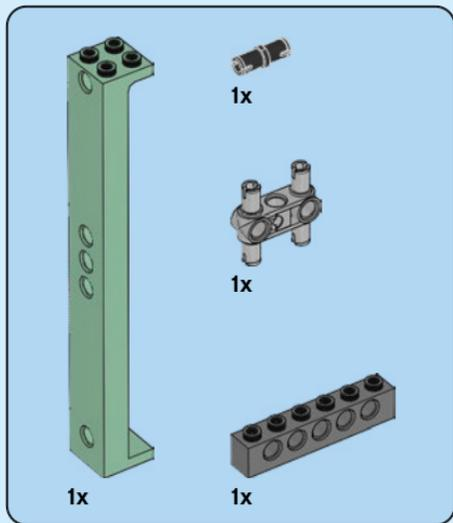

8

1

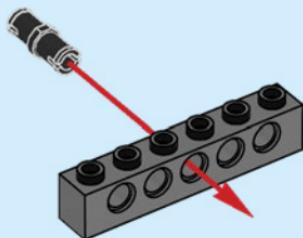

2

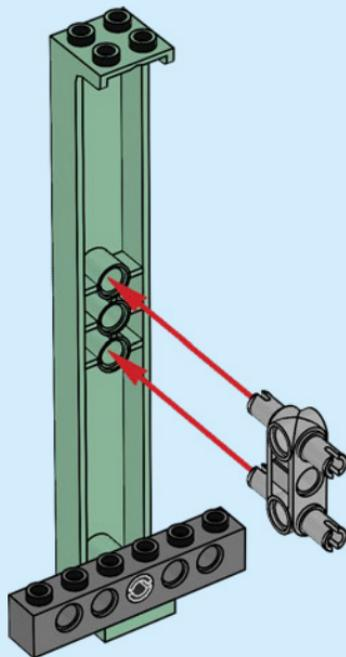

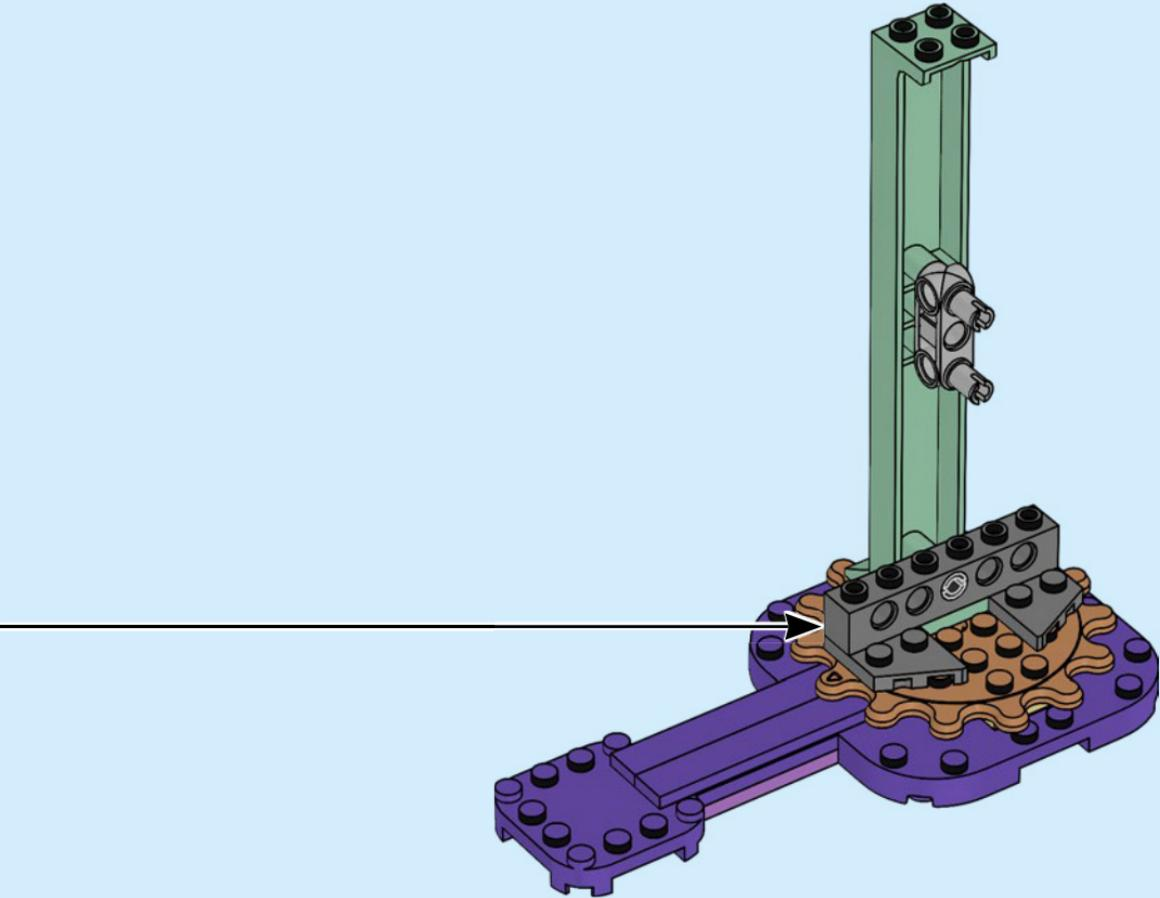

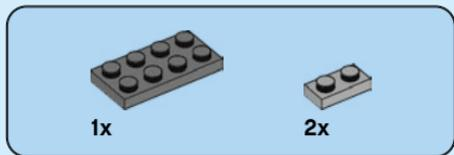
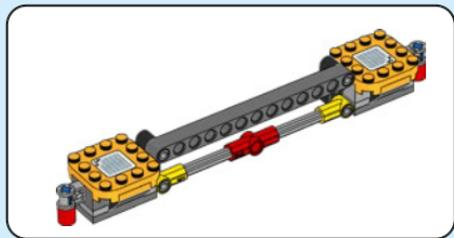

9

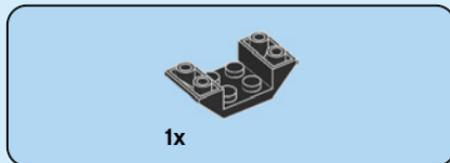
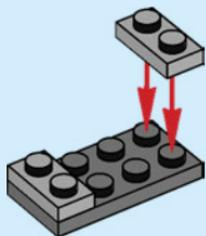

10

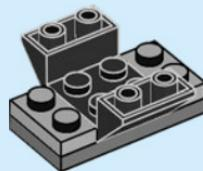

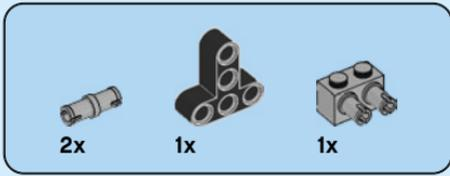

11

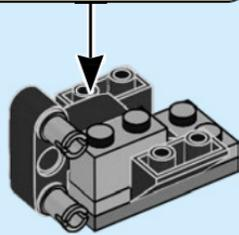
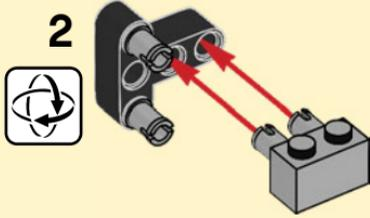
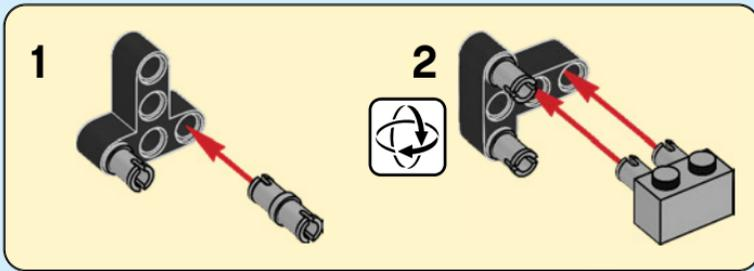



1x

12

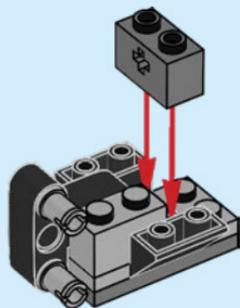

1x

13

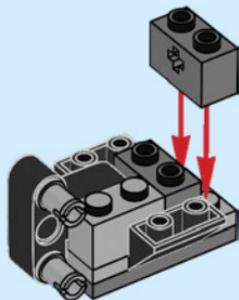

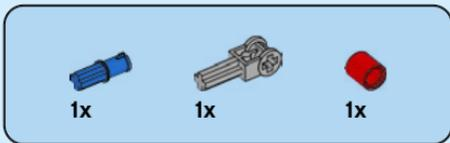

14

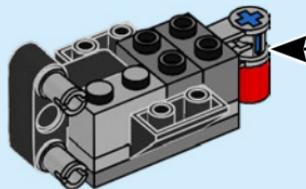
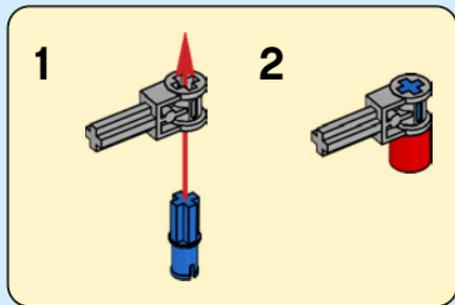

15

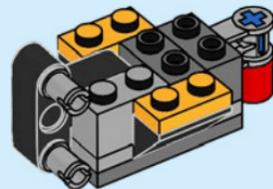



1x

16

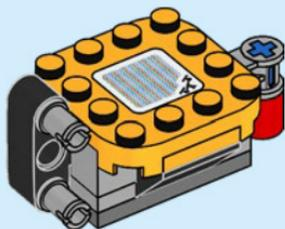

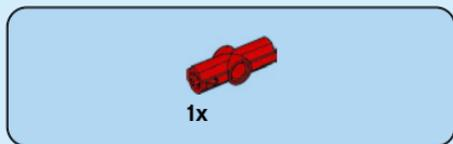
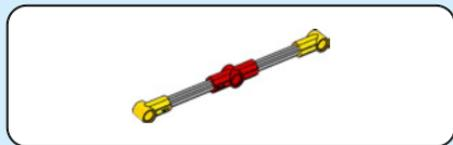

17

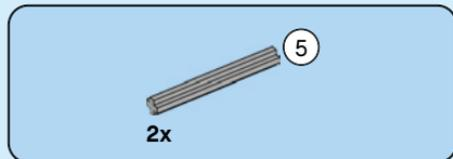

18

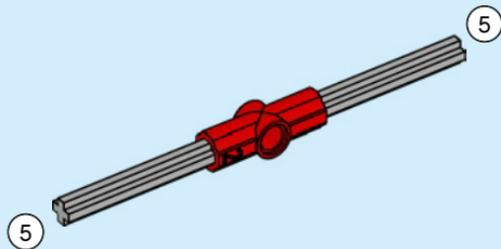



2x

19

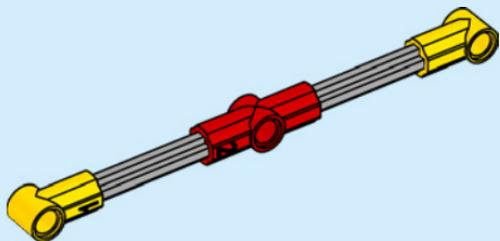

20

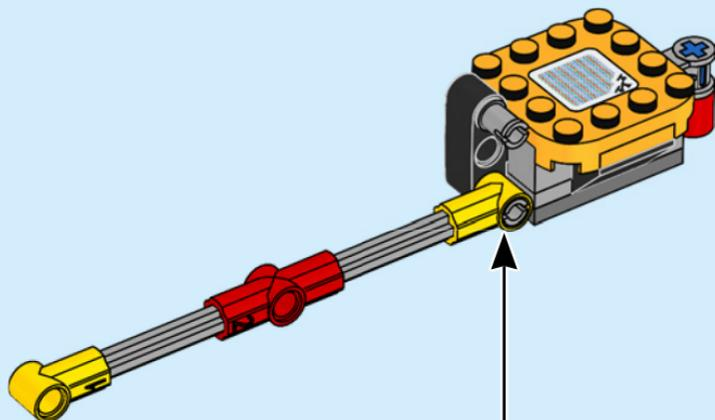

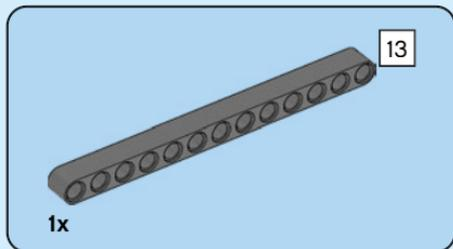

21

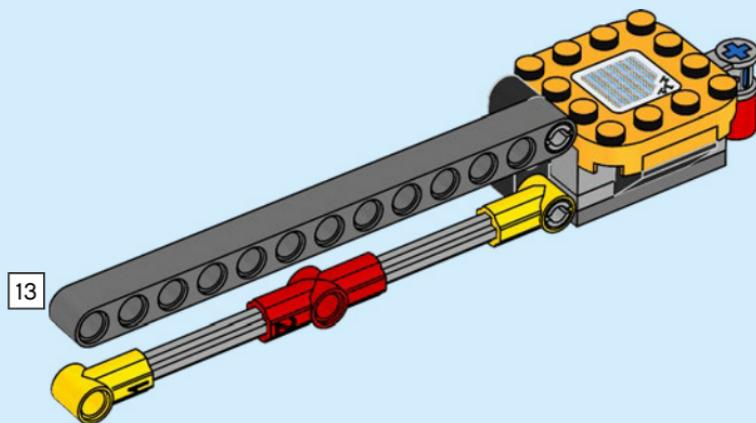

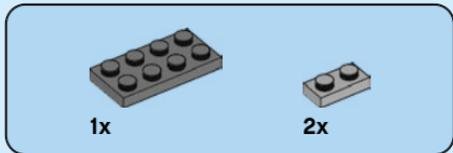

22

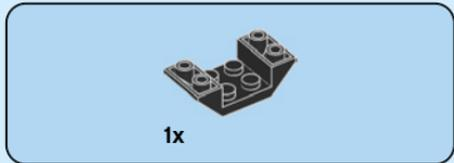
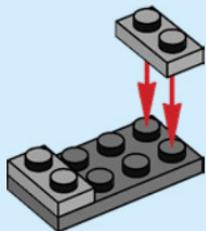

23

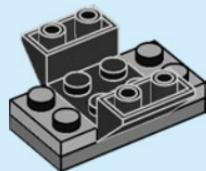

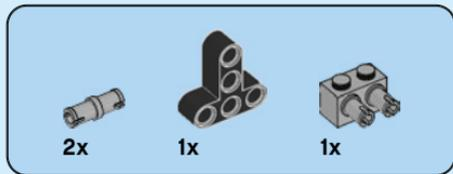

24

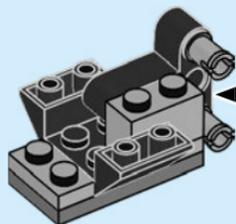
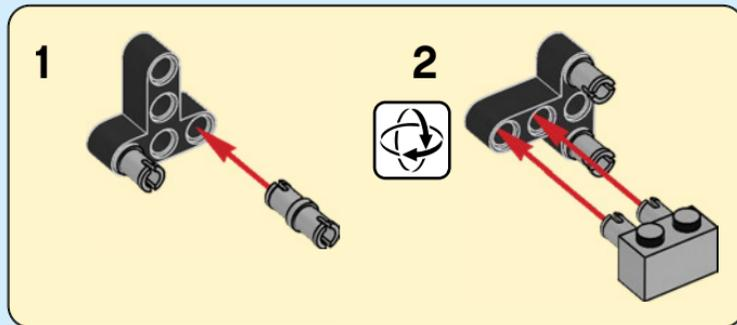



2x

25

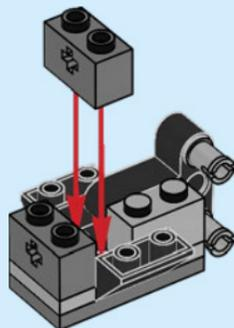

60



1x



1x



1x

26

1

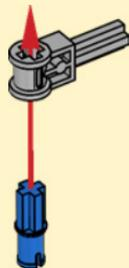

2

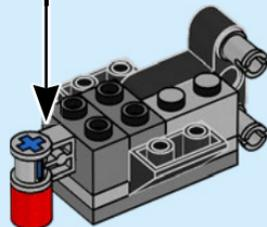



2x

27

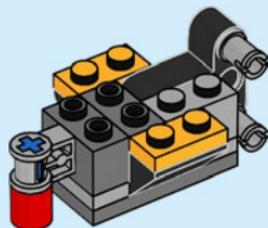

1x

28

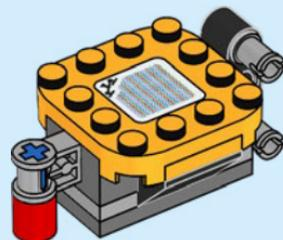

29

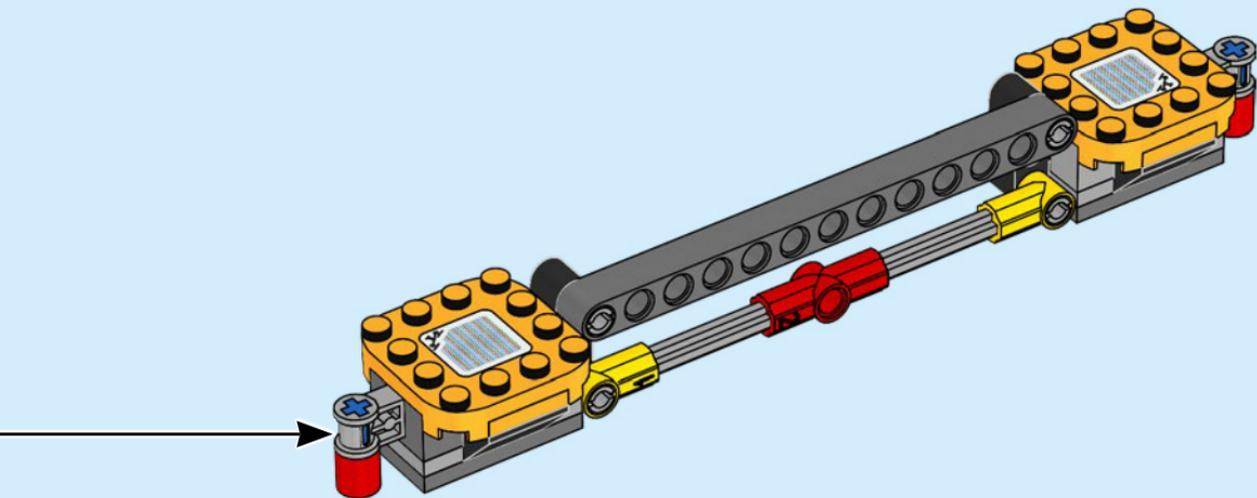

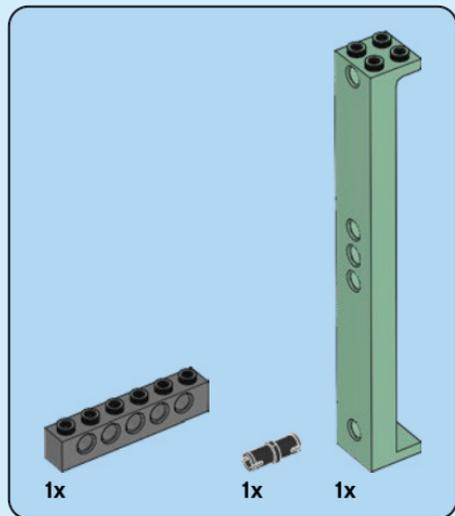

31

1

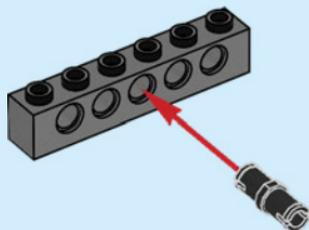

2

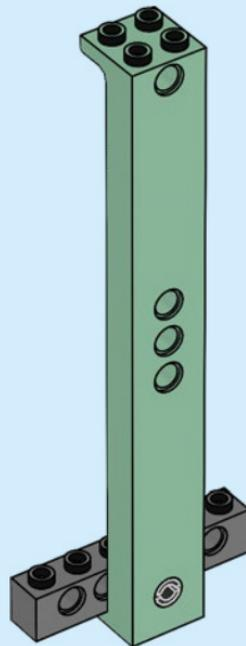

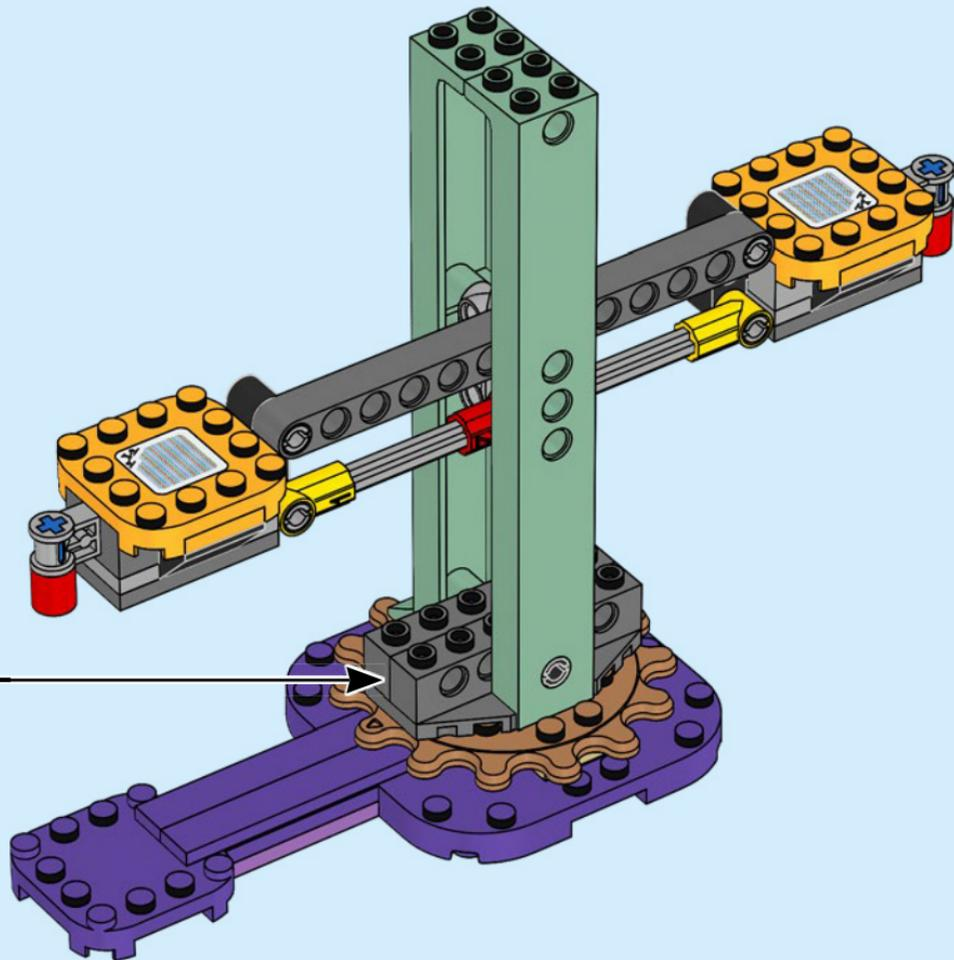

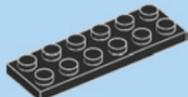

1x

32

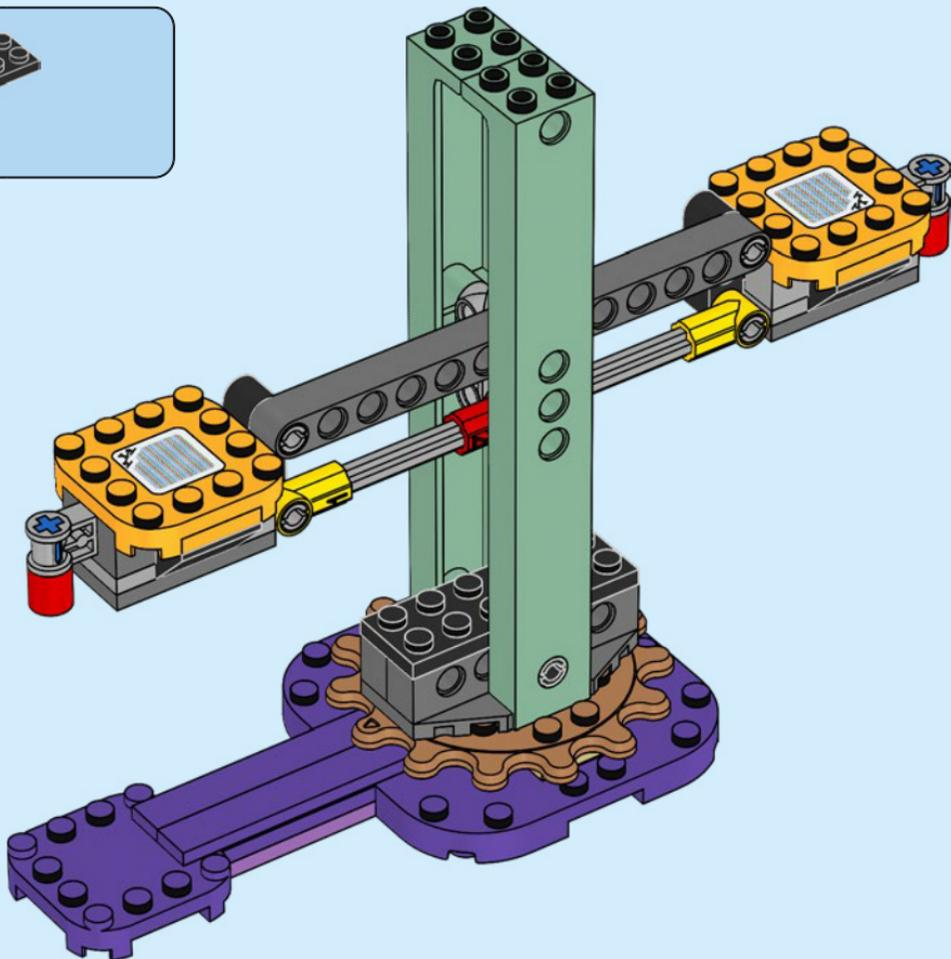



2x

34

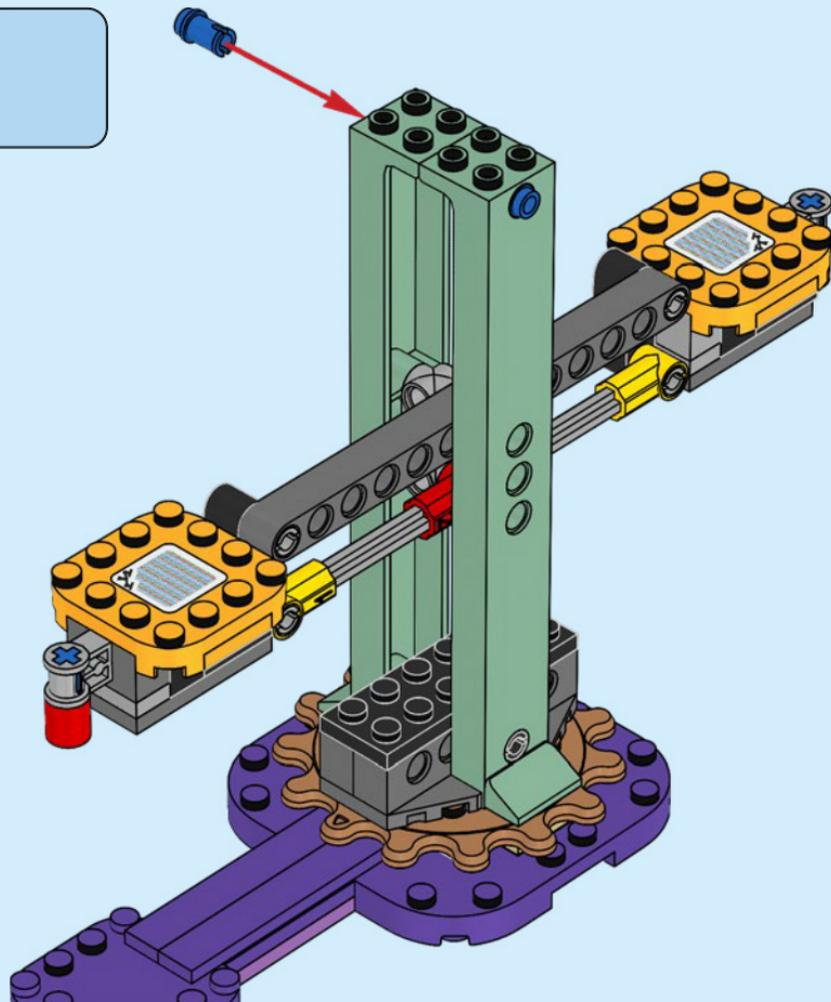

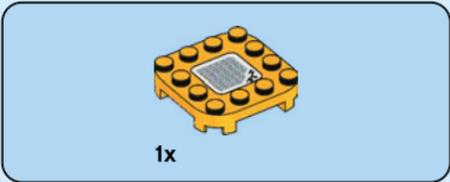

35

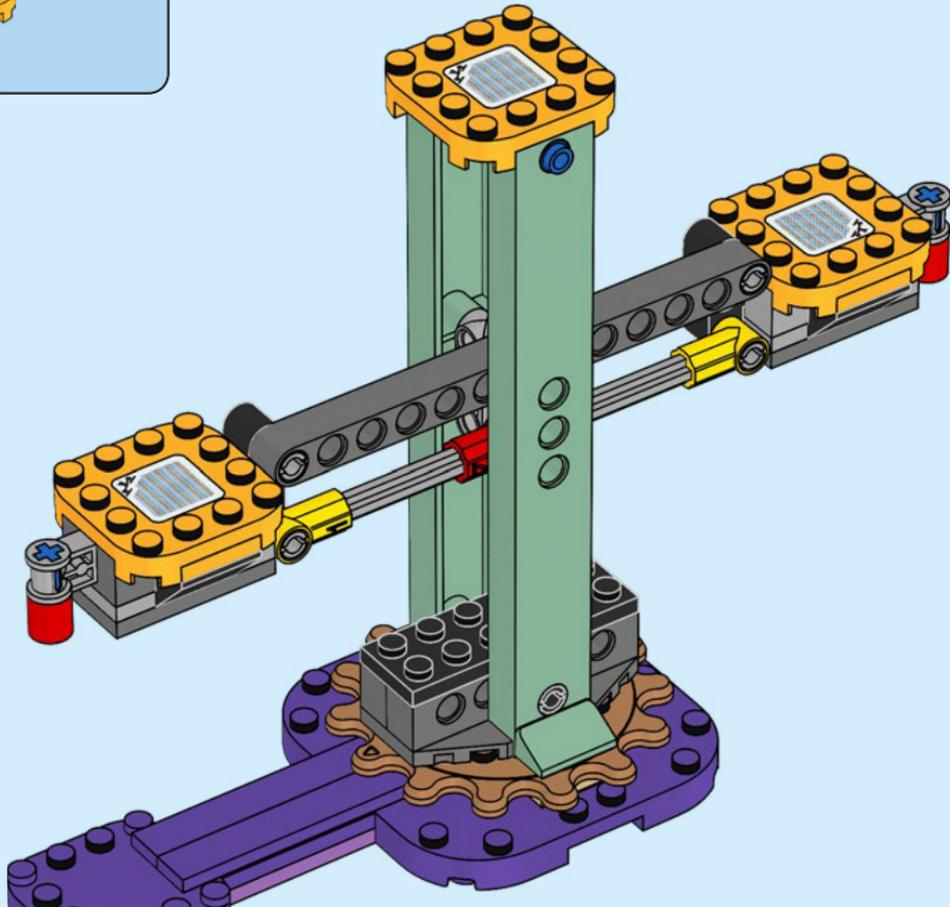



2x

36

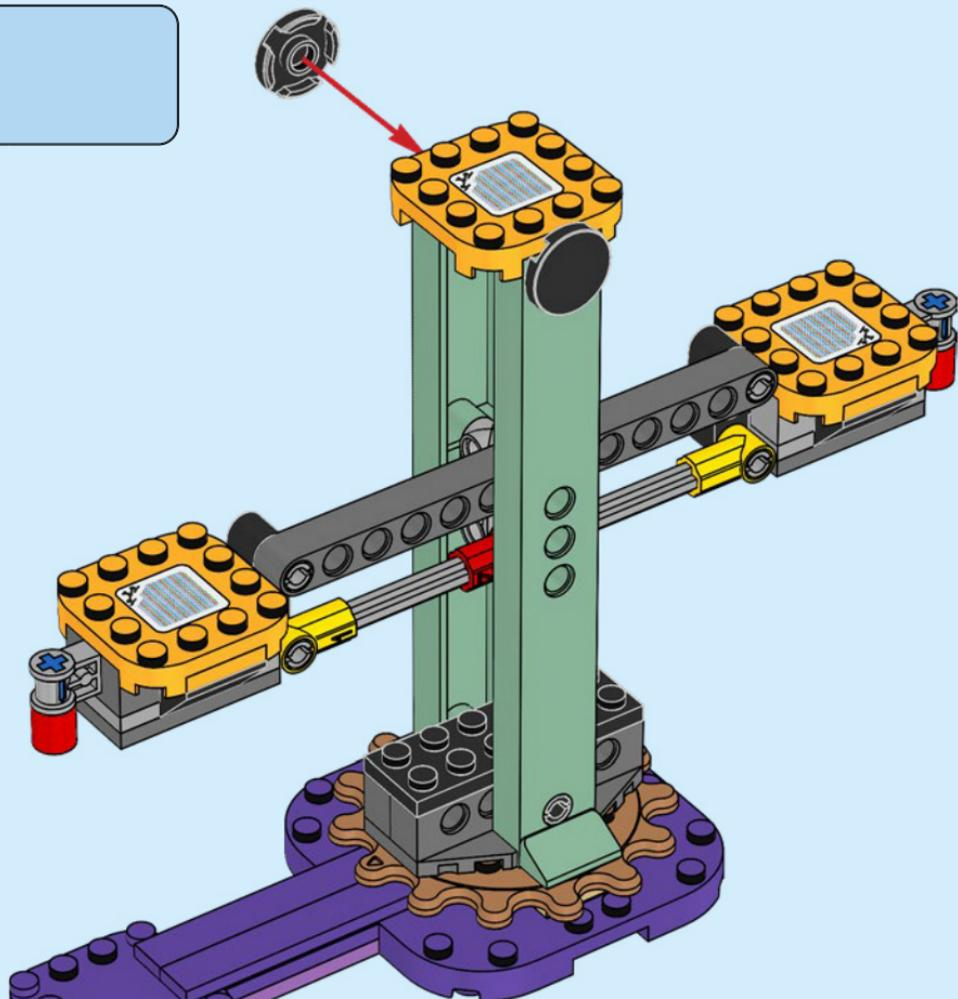

37

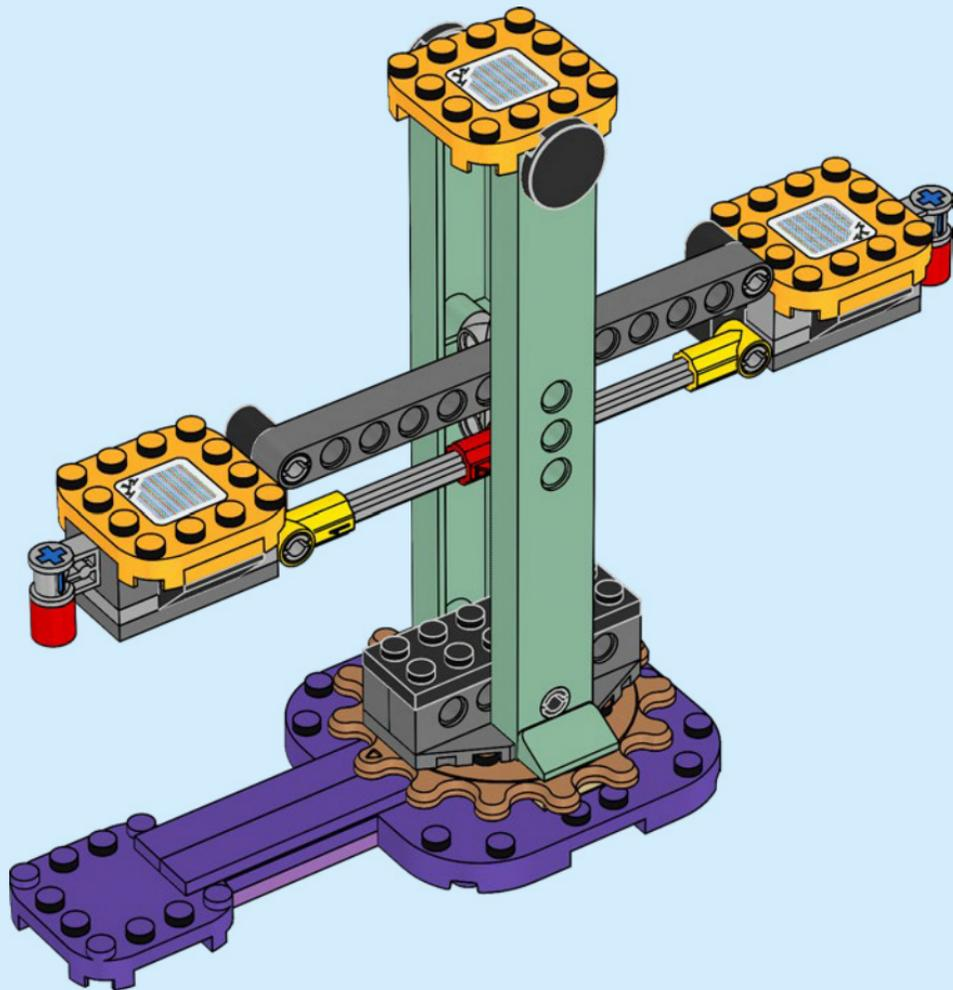

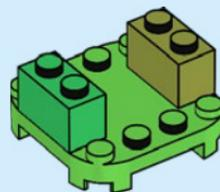
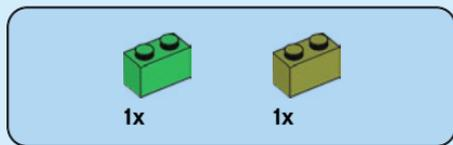
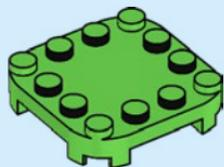
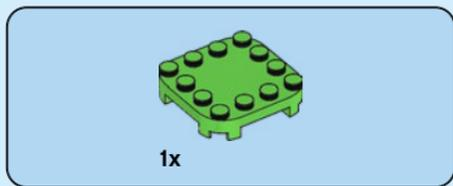
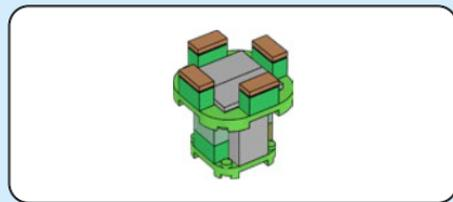
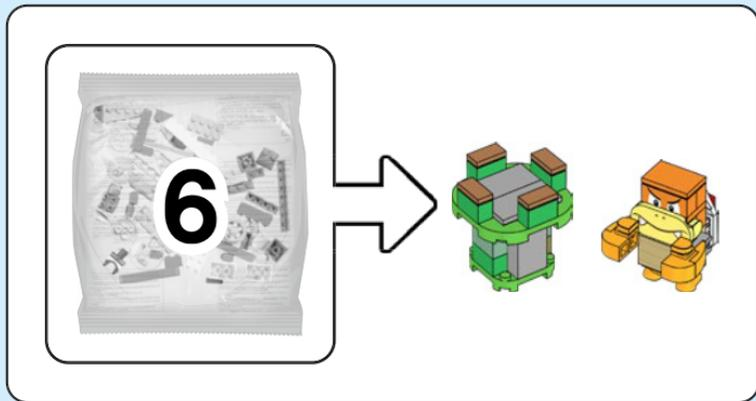

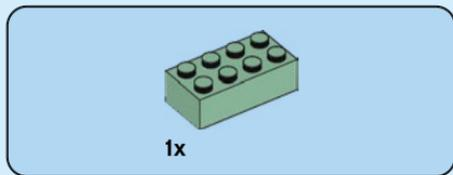

3

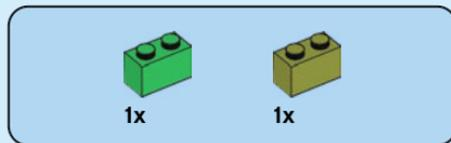
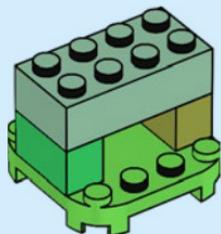

4

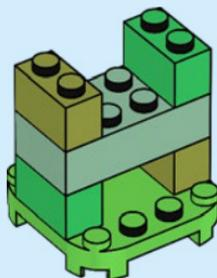

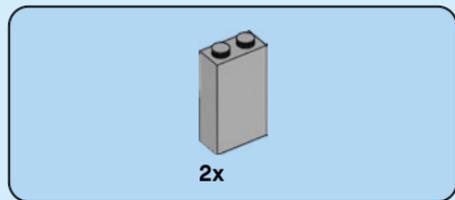

5

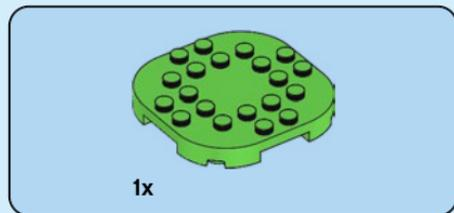
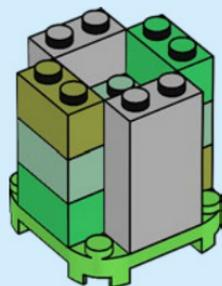

6

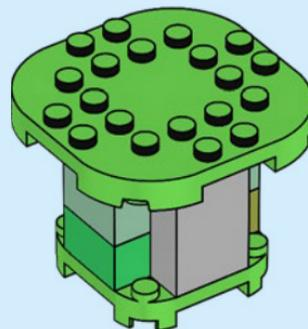

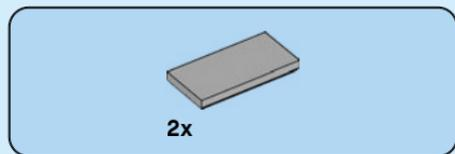

7

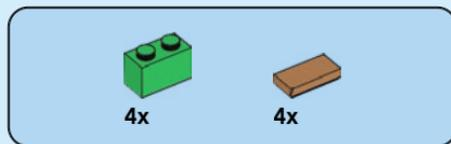
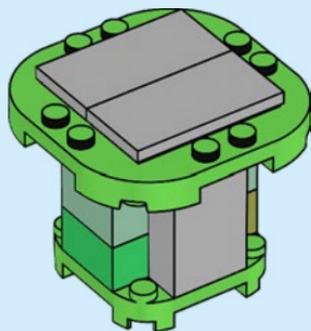

8

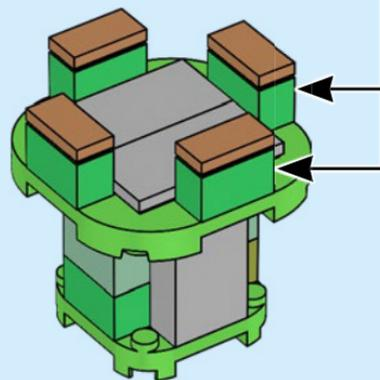
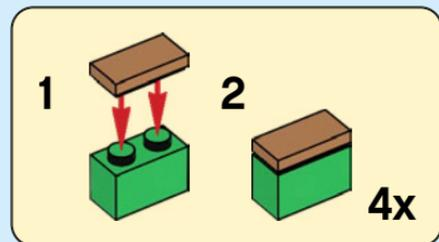

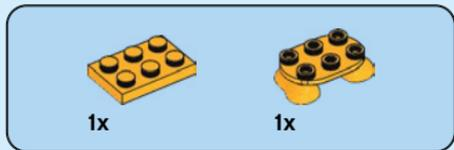

1

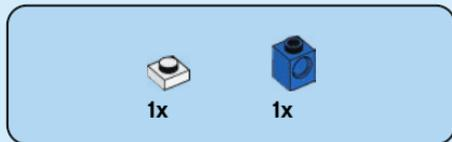
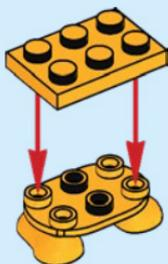

2

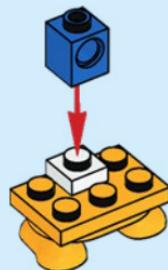

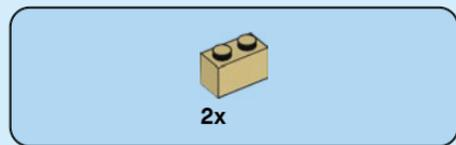

3

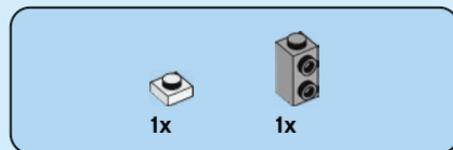

4

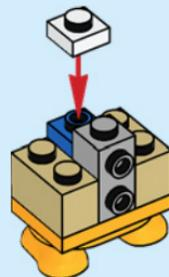



1x



2x

5

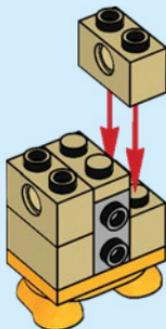

1x

6





2x

7

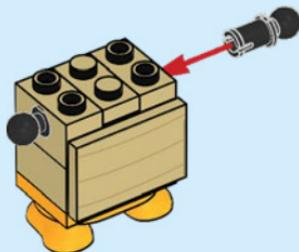

1x



2x

8





1x



2x

9



2x

10

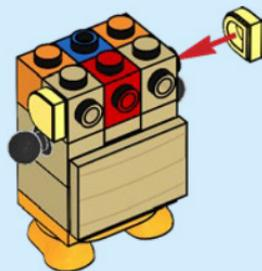



1x

11



1x



1x

12

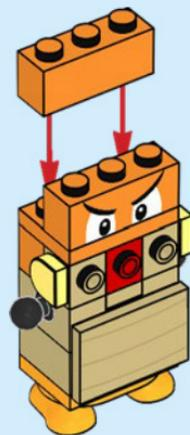

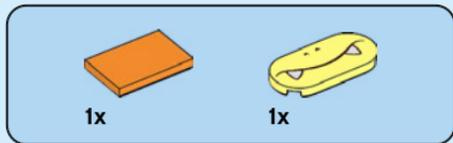

13



82

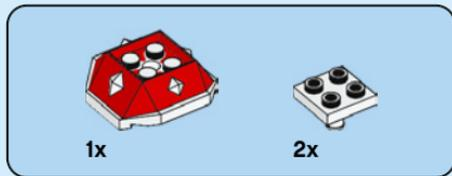

14

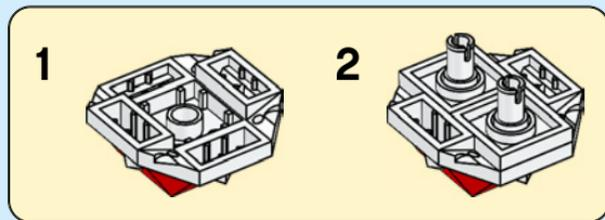



1x

15



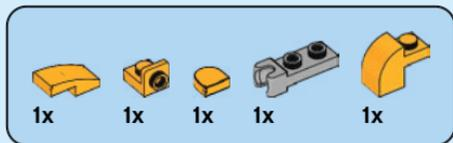

16

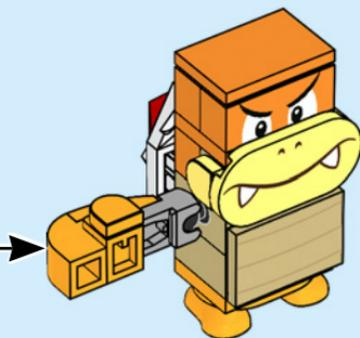
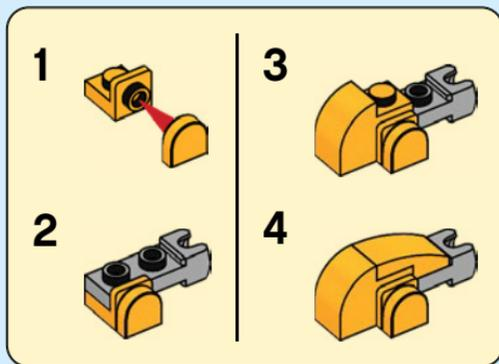

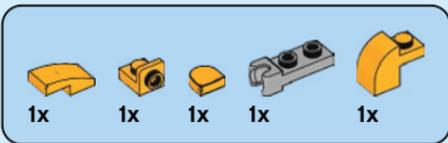

17

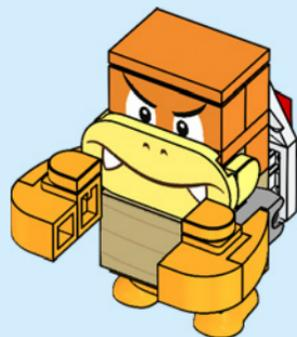
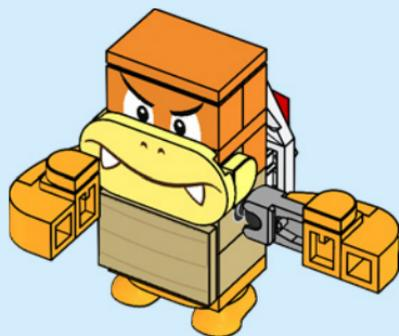
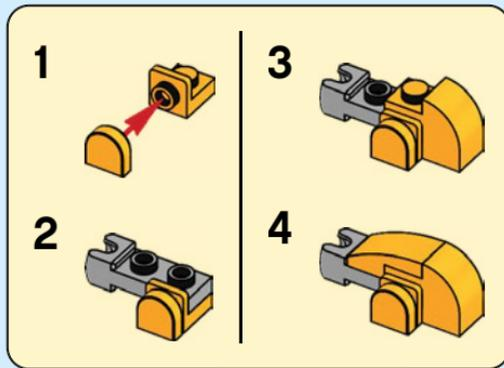





1

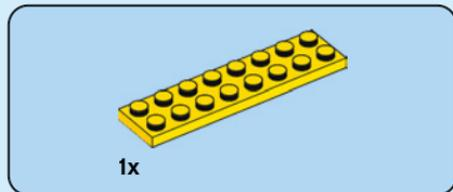
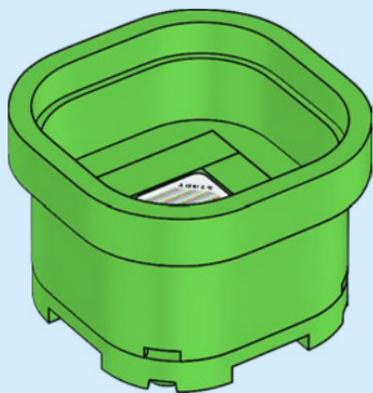

2

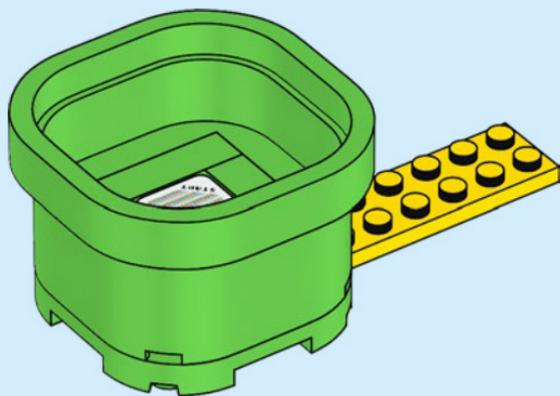



2x



2x

3

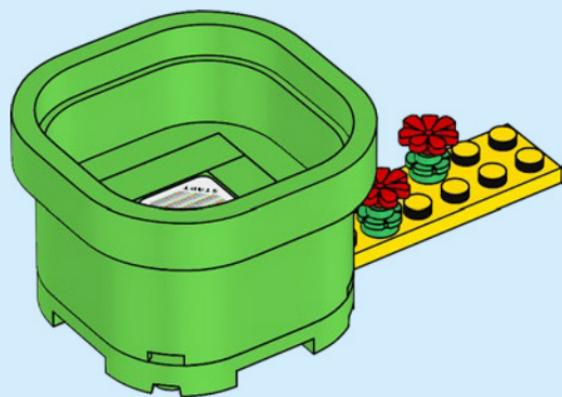
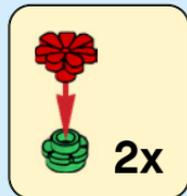

1x

4

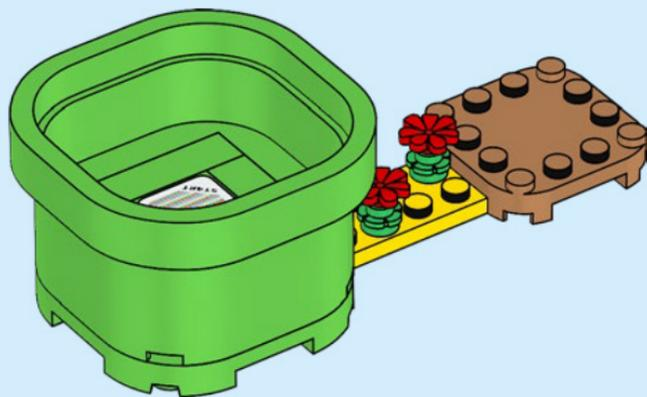

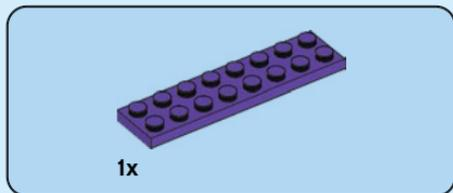

5

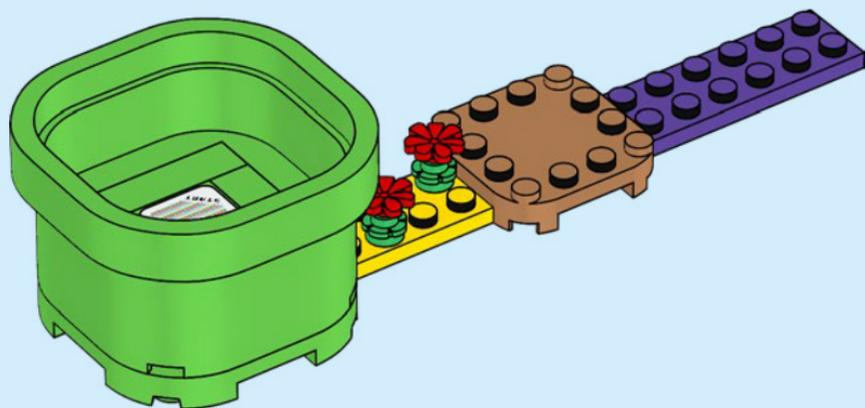

6

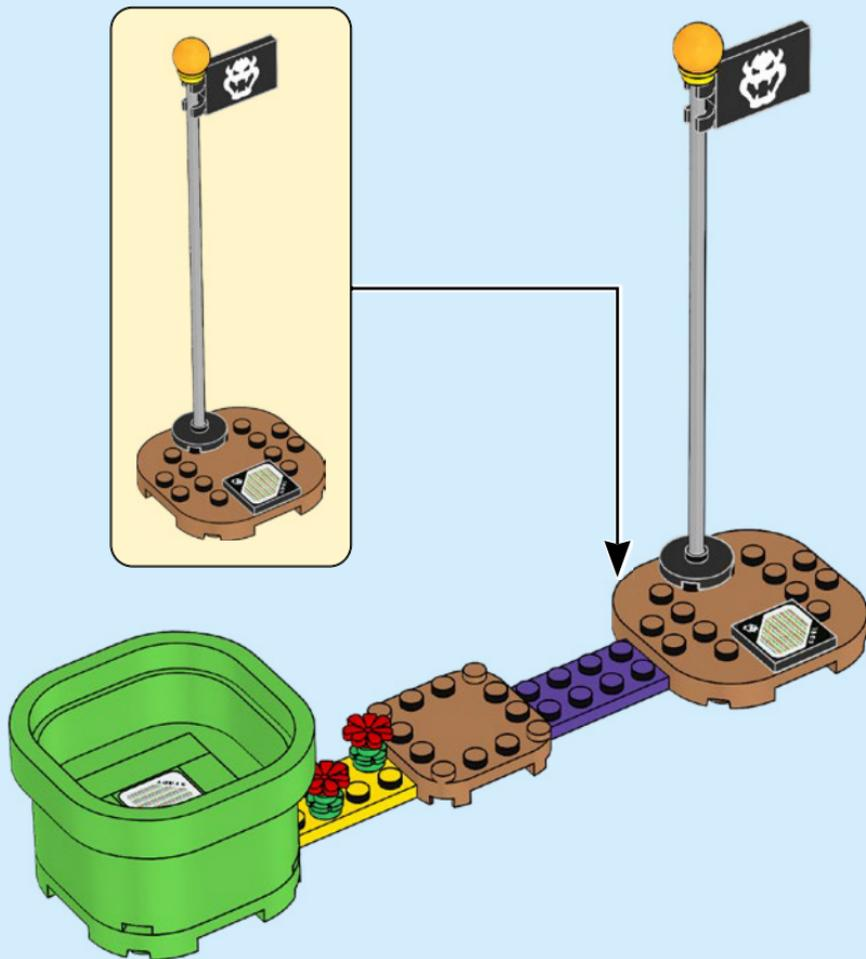

7

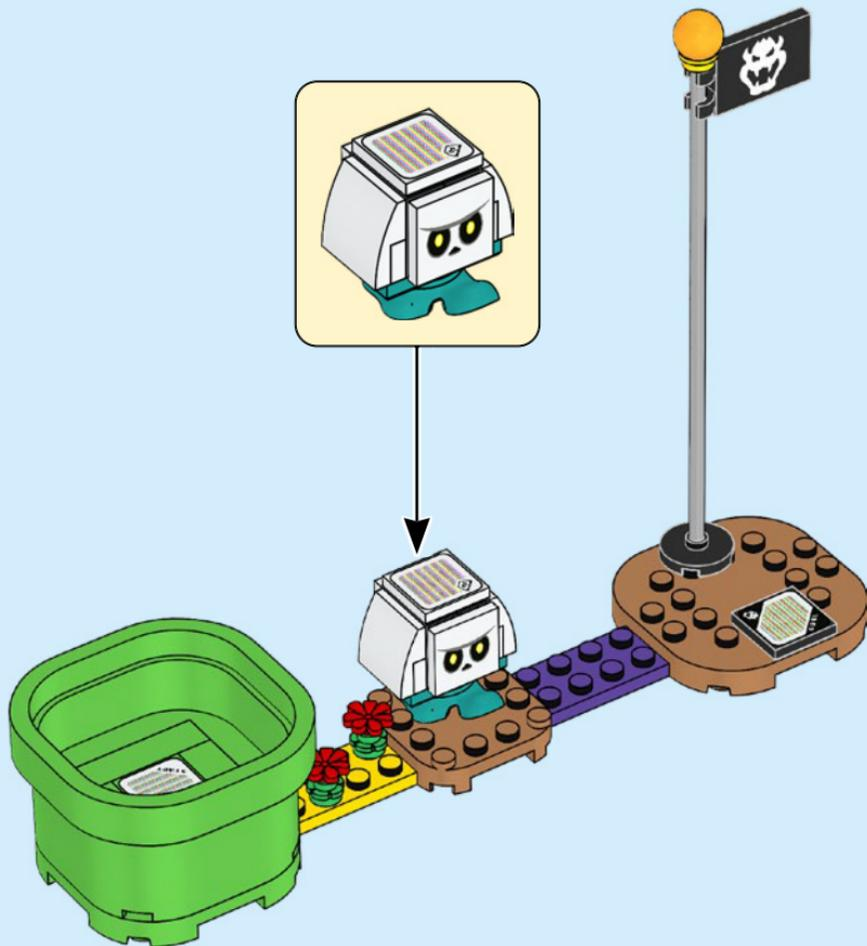



2x
302401



2x
6172366



2x
6044691



1x
6093053



1x
306901



2x
302301



2x
6312480



1x
4249563



2x
6313603



1x
6334685



1x
306801



2x
6047220



1x
6333979



1x
6302720



2x
6175968



4x
4114026



2x
4109995



2x
4205107



1x
4113917



1x
6353867



2x
4114319



2x
6182260



2x
6093950



1x
4558886



2x
6278441



1x
4278275



1x
6102138



1x
6354349



1x
6351572



2x
4143005



2x
4119014



2x
4206482



2x
6284577



1x
6168644



2x
6329889



3x
403224



2x
6353866



1x
6302719



1x
6315656



1x
302024



1x
6314197



1x
6314191

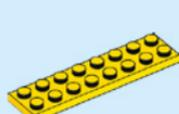

3x
303424



2x
306226



2x
6344752



2x
6279875



3x
6070695



1x
6195325



1x
6315659



2x
4552347



1x
6369098



2x
4188534



1x
6312482



3x
4517986



1x
379526



2x
6135287



1x
6038353



6x
4107736



1x
6299948



2x
303928



3x
4106356



5x
4647553



2x
6195258



1x
6354351



1x
6363295



2x
6195267



3x
6308875



2x
6301631



1x
6294708



1x
6166111





2x
4173805



1x
6353862



1x
4118787



1x
6293710



1x
4125278



1x
6357991



1x
6334098



1x
6334686



2x
6210479



2x
6353195



5x
6075626



2x
6357747



2x
6313554



1x
6071608



2x
6249235



4x
6028736



2x
6099728



2x
6374487



1x
6353232



1x
6097503



3x
6360150



1x
6351935



1x
6355368



4x
6170387



4x
4651063



2x
6284071



1x
6168647



1x
6225242



1x
6052200



4x
4211807



4x
6000066



4x
4211398



2x
6276874



1x
6354352



2x
6338163



2x
4211536



1x
6282158



2x
4560183



2x
4211639



4x
6178919



1x
6354332



2x
4527082



2x
4211065



2x
4210917



1x
6252371



1x
6186825



1x
4210678

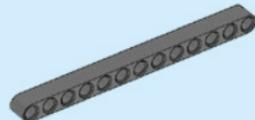

1x
4522937



1x
6206151



2x
6353190



2x
6240463



1x
6353194



2x
6264994



2x
6353192



Customer Service

Kundenservice

Service Consommateurs

Servicio Al Consumidor

LEGO.com/service or dial



00800 5346 5555 :



1-800-422-5346 :



1x
6353865



1x
4654128



1x
6353864



1x
6314374



1x
6353189



3x
6288181



2x
6359698



1x
6096589



1x
6371087



2x
6250598



1x
6353863



7x
6024722



2x
6315196



2x
6030277



2x
6334094



2x
4619657

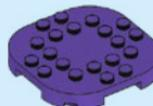

1x
6326550



2x
6109931

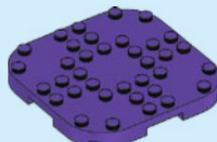

1x
6326551



4x
6021997



2x
6093494



5x
6308873



2x
6301636



3x
6226644



2x
6338455

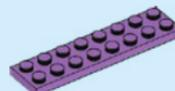

1x
6330087

1



+

1



1

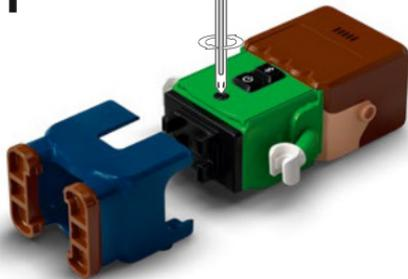

2



2xAAA

3



4



5



READY TO PLAY!
BEREIT ZUM SPIELEN!
PRÊT À ÊTRE UTILISÉ !
PRONTO PER IL GIOCO!
¡LISTO PARA JUGAR!
PREPARAR PARA JOGAR!
JÁTÉKRA KÉSZ!
SAGATAVOJIES SPĚLE!
准备玩乐!

READY
TO
PLAY!



2

**GET THE
LATEST
VERSION OF
THE APP!**



GET THE LATEST VERSION OF THE APP!
HOL DIR DIE NEUESTE VERSION DER APP!
OBTIENS LA DERNIÈRE VERSION DE L'APPLICATION !
SCARICA L'ULTIMA VERSIONE DELL'APP
¡DESCARGA LA VERSIÓN MÁS RECIENTE DE LA APP!
OBTÉM A ÚLTIMA VERSÃO DA APP!
TÖLTSD LE AZ ALKALMAZÁS LEGÚJABB VERZIÓJÁT!
IEGŪSTI JAUNĀKO LIETOTNES VERSIJU!
获取此应用程序的最新版本!



Digital building instruction in free app

Digitale Bauanleitungen in der kostenlosen App
Instructions de montage numériques dans l'appli gratuite
Istruzioni digitali per costruire nella app gratuita
Instrucciones de construcción digitales disponibles en la app gratuita
Instrução de construção digital na app grátis
Digitális összerelési útmutató az ingyenes alkalmazásban
Digitāla būvēšanas instrukcija bezmaksas lietotnē
免费应用程序内含数字拼搭说明

Check for compatibility
Kompatibilität prüfen
Vérifier la compatibilité
Controlla la compatibilità
Comprueba tu compatibilidad
Verificar a compatibilidade
Ellenőrizd a kompatibilitást
Pārbaudīt saderību
检查兼容性



LEGO® Super Mario™
[LEGO.com/devicecheck](https://www.lego.com/devicecheck)

5

Looking. Stand still!

Play challenge
Treasure huntMultiplayer
Weekly Challenge
Hidden Bonus

47

54

**MORE
FUN
IN THE
APP!**



MORE FUN IN THE APP!
NOCH MEHR SPASS IN DER APP!
AMUSE-TOI ENCORE PLUS AVEC L'APPLI !
TANTO DIVERTIMENTO IN PIU' NELL'APP!
¡MÁS DIVERSIÓN EN LA APP!
MAIS DIVERSÃO NA APP!
MÉG TÖBB MÓKÁT TALÁL SZ AZ APPBAN!
VÉL VAIRÁK JAUTRÍBAS LIETOTNĒ!
更多乐趣，尽在App应用程序！





Zzz





71360



71387



71388



71389



71390



71391

Starter Course 71360 and 71387 needed
 Starter set 71360 und 71387 wird benötigt
 Packs de démarrage 71360 et 71387
 nécessaires
 Starter Pack 71360 e 71387 necessario
 Se necesitan los sets Pack Inicial 71360
 y 71387

Necessita do Pack Inicial 71360 e 71387
 A 71360-as és a 71387-es Kezdőpálya
 szükséges
 Nepieciešami sákuma maršruta komplekti
 71360 un 71387
 需要入门套组 71360 和 71387





71390

71391



**TEAM UP
FOR
NEW
ADVENTURES!**

TEAM UP FOR NEW ADVENTURES!
ERLEBT GEMEINSAM NEUE ABENTEUER!
FORME UNE ÉQUIPE POUR VIVRE DE
NOUVELLES AVENTURES!
GIOCA CON GLI AMICI PER NUOVE
AVVENTURE!

¡FORMA EQUIPO Y VIVE NUEVAS AVENTURAS!
JUNTA-TE À EQUIPA PARA NOVAS AVENTURAS!
JÁTSSZ CSAPATBAN AZ ÚJ KALANDOKERT!
APVIENOJIET SPEKUS JAUNIEM
PIEDZĪVOJUMIEM!
一起踏上全新的探險之旅!



71360



71387



Starter Course 71360 and 71387 needed
Starterset 71360 und 71387 wird
benötigt
Packs de démarrage 71360 et 71387
nécessaires
Starter Pack 71360 e 71387 necessario
Se necesitan los sets Pack Inicial 71360
y 71387

Necessita do Pack Inicial 71360 e 71387
A 71360-as és a 71387-es Kezdőpálya
szükséges
Nepieciešami sākuma maršruta
komplekti 71360 un 71387
需要入门套组 71360 和 71387



**10 TO
COLLECT
SERIES
3**

10 TO COLLECT
10 ZUM SAMMELN
10 MODÈLES À COLLECTIONNER
10 DA COLLEZIONARE
10 PARA COLECCIONAR
10 PARA COLECIONAR
GYŰJTSD ÖSSZE MIND A 10-ET!
SAKRÁJ 10
共 10 个角色可供收集

SERIES 3
REIHE 3
SÉRIE 3
SÉRIE 3
3. SOROZAT
3. SÉRIJA
系列 3



71394



**POWER-UP
PACK**

POWER-UP PACK
POWER-UP-PAKET
PACK DE PUISSANCE
POWER UP PACK
PACK POTENCIADOR

PACK POWER-UP
SZUPERERŐ CSOMAG
SPĚJU KOMPLEKTS
增强包



71392



71393



EN

Important information about batteries

Never use different types of batteries together, or a combination of old and new batteries. Always remove the batteries if the product is not to be used for a long time or if the batteries have run down. Never use damaged batteries. Only use alkaline type batteries. Insert the batteries so that the poles are correctly positioned. Never attempt to recharge non-rechargeable batteries. Never short-circuit the battery holder.

DE

Wichtige Informationen zu Batterien

Benutzen Sie niemals unterschiedliche Arten von Batterien oder alte und neue gleichzeitig. Nehmen Sie stets die Batterien heraus, wenn mit dem Modell längere Zeit nicht gespielt wird oder wenn die Batterien leer sind. Verwenden Sie niemals beschädigte Batterien. Verwenden Sie ausschließlich Alkali-Batterien. Achten Sie beim Einsetzen der Batterien auf die richtige Polung. Versuchen Sie unter keinen Umständen, „normale“ Batterien wieder aufzuladen. Schließen Sie das Batteriefach niemals kurz.

FR

Informations importantes concernant les piles

Ne jamais utiliser un mélange de différents types de piles, ou de piles neuves et de piles anciennes ou déjà utilisées. Toujours retirer les piles si le produit n'est pas utilisé durant une période prolongée ou si les piles sont vides. Ne jamais utiliser de piles endommagées. N'utiliser que des piles alcalines. En insérant les piles, respecter scrupuleusement le sens d'orientation des pôles (+/-). Ne jamais essayer de recharger des piles non rechargeables. Ne jamais court-circuiter le compartiment des piles.

IT

Importanti informazioni sulle batterie

Non usare mai contemporaneamente batterie di tipo diverso o batterie nuove e usate insieme. Rimuovere sempre le batterie qualora il prodotto non venga utilizzato per periodi prolungati, oppure se le batterie sono esauste. Non utilizzare mai batterie danneggiate. Utilizzare solo batterie di tipo alcalino. Inserire le batterie avendo cura che la loro polarità sia corretta. Non tentare mai di ricaricare batterie non ricaricabili. Non cortocircuitare mai il portabatterie.

NL

Belangrijke informatie over batterijen

Gebruik nooit verschillende soorten of een combinatie van oude en nieuwe batterijen tegelijkertijd. Verwijder de batterijen altijd als je het product lange tijd niet wilt gebruiken of als batterijen leeg zijn. Gebruik nooit beschadigde batterijen. Gebruik alleen alkalinebatterijen. Plaats de batterijen met de polen in de juiste richting. Probeer nooit niet-oplaadbare batterijen opnieuw op te laden. Laat de batterijhouder nooit kortsluiten.

ES

Información importante acerca de las pilas

No use pilas de diferentes tipos ni pilas nuevas y antiguas para alimentar el producto. Extraiga las pilas del producto si este va a permanecer sin uso durante un período prolongado de tiempo o aquellas se han agotado. No use pilas dañadas. Use solo pilas alcalinas. Inserte las pilas de modo que los polos queden situados en las posiciones correctas. No trate de cargar pilas no recargables. No cortocircuite el compartimento de las pilas.

DA

Vigtige oplysninger om batterier

Brug aldrig forskellige batterityper sammen eller en kombination af gamle og nye batterier. Fjern altid batterierne, hvis produktet ikke skal bruges i lang tid, eller hvis batterierne er flade. Brug aldrig beskadigede batterier. Brug kun alkaliske batterier. Sæt batterierne i, så polerne vender den rigtige vej. Forsøg aldrig at oplade ikke-genopladelige batterier. Kortslut aldrig batteriholderen.

IS

Mikilvægar upplýsingar um rafhlöður

Aldrei skal nota mismunandi gerðir rafhlaða samtímis, né nýjar og eldri rafhlöður samtímis. Ef ekki á að nota tækið í lengri tíma eða ef rafhlöðurnar eru orðnar tómar skal fjarlægja rafhlöðurnar. Aldrei skal nota rafhlöður sem hafa skemmt. Eingöngu má nota alkaline-rafhlöður. Setja skal rafhlöðurnar í þannig að plús- og mínusskaut þeirra snúi rétt. Aldrei skal reyna að endurhlaða rafhlöður sem ekki eru endurhlaðanlegar. Aldrei ætti að valda skammhlaupi í rafhlöðuhöfninu.

FI

Tärkeää tietoa paristoista

Älä koskaan käytä erityyppisiä paristoja yhdessä. Älä myöskään käytä samassa laitteessa sekä vanhoja että uusia paristoja. Poista paristot tuotteesta aina, kun se on pitemmän aikaa käyttämättä, tai kun paristot ovat tyhjentyneet. Älä koskaan käytä viallisia paristoja. Käytä vain alkaliparistoja. Aseta paristot siten, että navat osoittavat oikeaan suuntaan. Älä koskaan aiheuta oikosulkua pariston kosketinten välillä.

SV

Viktig information om batterier

Använd aldrig olika sorters batterier samtidigt, och inte heller en kombination av gamla och nya batterier. Ta alltid ur batterierna om produkten inte ska användas under en längre tid eller om batterierna är slut. Använd aldrig skadade batterier. Använd endast alkaliska batterier. Sätt i batterierna så att polerna hamnar i rätt läge. Försök aldrig ladda icke-laddningsbara batterier. Kortslut aldrig batteriutrymmets kontaktytor.

NO

Viktig informasjon om batterier

Bruk aldri ulike typer batterier sammen og heller aldri gamle og nye batterier sammen. Ta alltid ut batteriene hvis produktet ikke skal brukes på lang tid, eller hvis batteriene er brukt opp. Bruk aldri skadde batterier. Bruk bare alkaliske batterier. Sett inn batteriene med polene vendt riktig vei. Forsøk aldri å lade opp ikke-oppladbare batterier. Kortslett aldri batteriholderen.

PT

Informação importante sobre as pilhas

Nunca use diferentes tipos de pilhas em simultâneo, ou uma combinação de pilhas usadas e novas. Retire sempre as pilhas se o produto não for usado durante muito tempo ou se as pilhas já não tiverem carga. Nunca use pilhas danificadas. Use apenas pilhas alcalinas. Insira as pilhas de forma a que os polos fiquem corretamente posicionados. Nunca tente recarregar pilhas não recarregáveis. Nunca deixe o compartimento das pilhas entrar em curto-circuito.

EL

Σημαντικές πληροφορίες για τις μπαταρίες

Μην χρησιμοποιείτε ποτέ διαφορετικούς τύπους μπαταριών μαζί και μην συνδυάζετε παλιές και καινούργιες μπαταρίες. Αφαιρείτε πάντα τις μπαταρίες αν δεν σκοπεύετε να χρησιμοποιήσετε το προϊόν για αρκετό καιρό ή αν οι μπαταρίες έχουν αδειάσει. Ποτέ μην χρησιμοποιείτε μπαταρίες που έχουν φθορές. Χρησιμοποιείτε μόνο αλκαλικές μπαταρίες. Τοποθετήστε τις μπαταρίες με τους πόλους στη σωστή θέση. Μην επιχειρήσετε ποτέ να επαναφορτίσετε μη επαναφορτιζόμενες μπαταρίες. Ποτέ μην βραχυκυκλώνετε τη θήκη των μπαταριών.

JA

電池取扱いに関する重要事項

異なるタイプの電池や古い電池を混ぜて使用しないでください。商品を長時間使用しないときや電池が切れたときは、電池を必ず取り外してください。不具合のある電池は絶対に使用しないでください。アルカリタイプの電池のみを使用してください。電極を確認して電池を正しい向きに入れてください。充電式ではない電池は絶対に充電しないでください。電池ホルダをショートさせないでください。

ZH

電池使用注意事项

请勿同时使用不同类型的电池, 或把新旧程度不同的电池混合使用。如果产品将有很长时间不会使用, 或者电池已经没电, 请注意取出电池。切勿使用已破损的电池。仅可使用碱性电池。装入电池时请注意正负极。请勿尝试给非充电电池充电。切勿对电池仓进行短路连接。

KO

배터리 사용 시 주의사항

다른 종류의 배터리를 함께 사용하거나, 새 전지와 오래된 전지를 혼용하지 마세요. 배터리가 방전되었거나 장기간 제품을 작동하지 않을 때에는 반드시 배터리를 분리하세요. 파손된 배터리는 사용하지 마세요. 알칼라인 타입의 배터리만을 사용하세요. 양극과 음극의 위치를 잘 맞춰서 넣으세요. 일반 배터리는 충전해서 사용할 수 없습니다. 배터리 홀더의 접촉부에 배터리를 정확히 끼워서 사용하세요.

RU

Необходимая информация об элементах питания

Ни в коем случае не используйте одновременно элементы питания различных типов, а также элементы питания с разным сроком годности. В обязательном порядке вынимайте элементы питания из терминалов в случае, если вы не пользуетесь прибором в течение долгого времени, либо в случае, если в элементах питания закончился заряд. Ни в коем случае не используйте поврежденные элементы питания. Используйте только элементы питания щелочного типа. Установите элементы питания, соблюдая указанную полярность. Ни в коем случае не пытайтесь подзаряжать непerezаряжаемые элементы питания. Ни в коем случае не пытайтесь замкнуть полюса в устройстве для элементов питания.

PL

Ważne informacje dotyczące baterii

Nigdy nie należy stosować razem różnych rodzajów baterii ani stosować równocześnie starych i nowych baterii. Jeżeli produkt nie jest używany przez dłuższy czas lub jeżeli baterie się wyczerpały, należy wyjąć baterie. Nigdy nie należy stosować uszkodzonych baterii. Należy używać wyłącznie baterii alkalicznych. Przy wkładaniu baterii należy zwrócić uwagę na właściwe położenie biegunów. Nigdy nie należy próbować ładowania baterii jednorazowych. Nigdy nie należy doprowadzać do zwarcia w gnieździe baterii.

CZ

Důležitá informace o bateriích

Nikdy nepoužívejte najednou různé typy baterií nebo kombinaci starých a nových baterií. Nebude-li se výrobek delší dobu používat nebo jsou-li baterie vybité, vždy je vyjměte z výrobku. Nikdy nepoužívejte poškozené baterie. Používejte pouze alkalické baterie. Baterie instalujte se správnou orientací pólů. Nikdy se nesnažte nabíjet baterie, které nejsou nabíjitelné. Nikdy nezkratujte kontakty v prostoru pro baterie.

SK

Dôležitá informácia o batériách

Nikdy nepoužívajte naraz odlišné typy batérií ani nekombinujte staré batérie s novými. Batérie vždy vyberte, ak sa výrobok nebude dlhšie používať, alebo ak sa batérie vybili. Nikdy nepoužívajte poškodené batérie. Používajte iba alkalické batérie. Batérie vkladajte so správnou orientáciou pólou. Nikdy sa nesnažte nabíjať batérie, ktoré nie sú nabíjateľné. Nikdy neskratujte kontakty v priestore pre batérie.

HU

Fontos tudnivalók az elemekről

Soha ne használjon különböző típusú elemeket, illetve ne használjon vegyesen új és használt elemeket. Mindig távolítsa el az elemeket, ha a készülékét előre láthatóan hosszabb ideig nem fogják használni, vagy ha az elemek lemerültek. Soha ne használjon megrongálódott elemeket. Csak alkáli elemeket használjon! Az elemeket helyesen helyezze be, a polaritásuknak megfelelően. Soha ne próbálja meg feltölteni a nem tölthető elemeket. Soha ne hozzon létre rövidzárlatot az elemtartó kivezetésein.

UA

Необхідна інформація про батареї

Ніколи не використовуйте одночасно батареї різних типів або батареї з різним терміном придатності. Обов'язково вилучайте батареї з приладу, якщо довго не користуетесь ним, або якщо в батареях уже скінчився заряд. Ніколи не використовуйте пошкоджені батареї. Використовуйте лише лужні батареї. Вставляйте батареї, враховуючи задану полярність. У будь-якому випадку не намагайтеся підзарядити батареї, що не підлягають підзарядці. У будь-якому випадку не намагайтеся зробити коротке замикання в приладі для батарей.

HR

Važno obavijesti o bateriji

Nikada nemoj koristiti različite vrste baterija zajedno, isto tako ni kombinaciju starih i novih baterija. Uvijek izvadi baterije ako dugo nećeš koristiti proizvod ili ako su one potrošene. Nikada nemoj koristiti oštećene baterije. Upotrebljavajte samo alkalne baterije. Umetni baterije pazeći da dobro okreneš polove. Nikada ne pokušavaj puniti baterije koje nisu predviđene za punjenje. Nikada ne izazivaj kratki spoj u držaču baterija.

SR

Важне информације о батеријама

Nikada ne koristite različite tipove baterija zajedno niti kombinaciju starih i novih baterija. Uvek izvadite baterije ukoliko proizvod nežete dugo vreme koristiti ili ukoliko su baterije prazne. Nikada ne koristite oštećene baterije. Koristite samo alkalne baterije. Stavite baterije tako da su polovi pravilno pozicionirani. Nikada ne pokušavajte da punitе baterije koje ne mogu da се pune. Nikada ne izazivajte kratak spoj у kuћишту за батерије.

MK

Важни информации за батериите

Nikogаш ne koristete različni tipovi baterii заедно или комбинација од стари и нови батерији. Секогаш отстранувајте ги батериите доколку не го користите производот подолго време или доколку се потрошиле. Никогаш не користете оштетени батерији. Користете само алкални батерији. Вметнете ги батериите така што точно ќе ги наместите половите. Никогаш не обидувајте се да ги полните батериите за еднократна употреба. Никогаш не предизвикувајте краток spoj на држачот за батерији.

SL

Pomembne informacije o baterijah

Nikoli ne uporabljajte skupaj različnih baterij ali kombinacije starih in novih baterij. Vedno odstranite baterije, če izdelka dlje časa ne boste uporabljali ali če so iztrošene. Nikoli ne uporabljajte poškodovanih baterij. Uporabljajte le alkalne baterije. Baterije vstavite tako, da so njihovi polji pravilno obrnjeni. Nikoli ne poskušajte polniti baterij, ki niso akumulatorske. Pazite, da ležišč za baterije ne boste spravili v kratek stik.

RO

Informații importante despre baterii

Nu folosiți niciodată împreună tipuri diferite de baterii, sau o combinație de baterii vechi și noi. Îndepărtați întotdeauna bateriile dacă produsul nu este folosit timp îndelungat sau dacă bateriile s-au epuizat. Nu folosiți niciodată baterii deteriorate. Utilizați numai baterii de tip alcalin. Introduceți bateriile astfel ca poli să fie poziționați corect. Nu încercați niciodată să reincărcați baterii nereincărcabile. Nu scurtcircuitați niciodată suportul bateriei.

BG

Важна информация за батериите

Никога не използвайте едновременно различни типове батерии или комбинация от стари и нови батерии. Винаги изваждайте батериите, ако изделието няма да се използва продължително време или ако батериите са се изтозили. Никога не използвайте повредени батерии. Използвайте само алкални батерии. Поставете батериите така, че полюсите да са разположени правилно. Никога не свързвайте да зареждате батерии, които не са акумулаторни. Никога не свързвайте на късо контактите на отделението за батериите.

LV

Svarīga informācija par baterijām

Nekad vienlaikus nelietojiet dažādu tipu, kā arī vecas un jaunās baterijas. Vienmēr izņemiet baterijas, ja tās ir izlādējušas vai ja produkts ilgāku laiku netiek lietots. Nekad nelietojiet bojātas baterijas. Izmantojiet tikai sārma tipa baterijas, lievietojot baterijas, ievērojiet pareizu polaritāti. Nekad nemēģiniet uzlādēt baterijas, kas nav uzlādējamas. Nepieļaujiet īssavienojumu bateriju nodalījumā.

ET

Oluline teave patareide kohta

Ära kunagi kasuta koos erinevat tüüpi patareisid, samuti vanu ja uusi patareisid. Kui mänguasja ei kasutata pika aja jooksul, võta patarei sellest välja. Ära kunagi kasuta kahjustatud patareisid. Kasuta ainult leelispatareisid. Pane patareid mänguasja sisse nii, et pluss- ja miinusleemmi asend oleks õige. Ära kunagi proovi akulaadijaga laadida tavalisi patareisid. Patareipesa klemmide vahel ei tohi tekkida lühis.

LT

Svarbi informacija apie elementus

Vienu metu nenaudokite skirtingų elementų, taip pat su naujais elementais nenaudokite senų. Jei mėnguasja neišnaudosite gaminio ilgesnį laiką arba jei elementai išseko, visuomet išimkite juos iš gaminio. Niekada nenaudokite pažeistų elementų. Naudokite tik šarminius elementus. Elementus dėkite atsižvelgdami į jų poliškumą. Niekada nebandykite įkrauti vienkartinį elementų. Saugokitės, kad elementų dėkle nesukeltumėte trumpojo jungimo.

TR

Piller hakkında önemli bilgiler

Hiçbir zaman farklı tipte pilleri ya da eski pillerle yeni pilleri bir arada kullanmayın. Ürün uzun süre kullanılmayacaksa ya da piller bitmişse, pilleri ürünün içinden çıkarın. Hiçbir zaman zedelenmiş piller kullanmayın. Sadece alkanin piller kullanın. Pilleri kutupları doğru konumda olacak şekilde yerleştirin. Hiçbir zaman, şarj edilebilir olmayan pilleri şarj etmeye çalışmayın. Hiçbir zaman pil kutusuna kısa devre yaptırmayın.

AR

معلومات مهمة عن البطاريات

يحظر استخدام أنواع مختلفة من البطاريات معا أو مزيج من البطاريات القديمة و الجديدة. احرص دائما على نزع البطاريات في حال عدم استخدام المنتج لفترة طويلة او إذا نفذت طاقة البطاريات. تجنب استخدام البطاريات النالفة. لا تستخدم إلا البطاريات القلوية فقط. قم بتكيب البطاريات بحيث تكون الأقطاب في موضعها الصحيح. يحظر إعادة شحن البطاريات غير القابلة لإعادة الشحن. تجنب إحداث دائرة قصر في حامل البطارية.

ID

Informasi penting tentang baterai

Jangan gunakan baterai yang jenisnya berlainan, atau mencampur baterai lama dan baterai baru. Lepas baterai jika produk tidak akan digunakan untuk waktu lama atau jika baterai sudah lemah. Jangan gunakan baterai yang rusak. Gunakan hanya baterai alkali. Masukkan baterai dengan posisi kutub yang tepat. Jangan pernah coba mengisi ulang baterai biasa. Jangan pernah membuat arus pendek pada dudukan baterai.

MS

Maklumat penting tentang bateri

Jangan guna jenis bateri yang berbeza bersama-sama, atau gabungan bateri baharu dan lama. Tanggalkan bateri jika produk tidak akan digunakan untuk tempoh masa yang lama atau jika bateri telah kehabisan kuasa. Jangan guna bateri yang rosak. Guna bateri jenis alkali sahaja. Selitkan bateri supaya paksi berada pada kedudukan yang betul. Jangan cuba untuk mengecap semula bateri yang tidak boleh dicaskan semula. Jangan pintas litar pemegang bateri.



EN
Protect the environment by not disposing of this product with your household waste.

Check with your local authority for recycling advice and facilities.

DE
Schützen Sie die Umwelt und entsorgen Sie dieses Produkt nicht mit Ihrem Hausmüll.
Informationen zu Recycling-Möglichkeiten erhalten Sie bei den örtlichen Behörden.

FR
Protégez l'environnement : ne jetez pas ce produit avec vos autres déchets ménagers.
Contactez les autorités locales pour obtenir des informations sur le recyclage et connaître les points de collecte.

IT
Proteggi l'ambiente! Non smaltire questo prodotto con i rifiuti domestici.
Per consulenza sul riciclaggio dei rifiuti e le strutture di riciclaggio, rivolgersi alle proprie autorità locali.

NL
Bescherm het milieu: gooi dit product niet samen met het andere huisvuil weg.
Raadpleeg de plaatselijke instanties voor locaties van milieustations en advies over hergebruik.

ES
Proteja el medio ambiente no deshaciéndose de este producto junto con sus residuos domésticos.
Solicite asesoramiento e información sobre instalaciones de reciclaje a las autoridades locales.

DA
Beskyt miljøet! Smid ikke dette produkt ud sammen med husholdningsaffaldet.
Få vejledning om genbrug og genbrugsstationer hos din kommune.

IS
Stuðlið að umhverfisvernd með því að farga þessari vöru ekki með heimilissorpi.
Leitið upplýsinga um endurvinnslu- og förgunarstaði hjá yfirvöldum á hverjum stað.

FI
Tämä tuote on hävitettävä ympäristöystävällisesti ja erillään muusta talousjätteestä.
Tietoja kierrätyksestä ja keräyspisteiden sijainnista saat paikkakuntasi teknisestä virastosta.

SV
Skydda miljön genom att inte kasta denna produkt bland ditt hushållsavfall.
Kontakta din kommun för frågor om återvinning och miljöstationer.

NO
Beskytt miljøet. Ikke kast dette produktet i husholdningsavfall.
Kontakt kommunen for veiledning om gjenbruk og miljøstasjoner.

PT
Proteja o ambiente não eliminando este produto com o seu lixo doméstico.
Consulte as autoridades locais para informação sobre reciclagem e sistemas de recolha.

EL
Προστατέψτε το περιβάλλον. Μην πετάτε αυτό το προϊόν μαζί με τα συνηθισμένα οικιακά απορρίμματα.
Επικοινωνήστε με τις τοπικές αρχές σχετικά με συμβουλές και εγκαταστάσεις ανακύκλωσης.

JA
環境保護のため、本製品は家庭ごみとは別に処分してください。
リサイクルに関する指示や施設については、お住まいの地方自治体にお問い合わせください。

ZH
注意保护环境，请勿将本产品与生活垃圾一起丢弃处理。
请咨询当地相关部门，了解与回收相关的设施与建议。

KO
환경 보호를 위해 이 제품을 생활폐기물과 함께 버리지 마십시오.
재활용 방법 및 시설에 관한 사항은 현지 관계 당국에 문의하십시오.

RU
Позаботьтесь об окружающей среде: не утилизируйте этот продукт вместе с бытовым мусором.
Узнайте в органах местного самоуправления правила вторичной переработки и утилизации таких отходов.

PL

Aby chronić środowisko naturalne, nie należy wyrzucać tego produktu wraz z odpadkami z gospodarstwa domowego.
W celu uzyskania wskazówek dotyczących recyklingu oraz adresów zakładów należy skontaktować się z lokalnym urzędem.

CZ

Nevyhazujte tento produkt do domácího odpadu, chráňte životní prostředí. Zjistěte si prosím u místních úřadů možnosti recyklace a dostupná zařízení.

SK

Nevyhadzujte tento produkt do domáceho odpadu, chráňte životné prostredie. Zistite si na miestnych úradoch možnosti recyklácie a dostupné zariadenia.

HU

Környezetét óvja, ha ettől a terméktől nem a háztartási hulladékkal együtt válik meg.
Érdeklődjék a lakóhelyéhez közel eső hatóságnál az újrahasznosítás módjáról és lehetőségeiről.

UA

Допоможіть захистити довкілля: не утилізуйте цей виріб разом із побутовим сміттям.
Вказівки з утилізації та відомості про пункти прийому з'ясуйте в місцевих компетентних органів.

HR

Zaštitite okoliš tako da ovaj proizvod ne odložite u otpad zajedno s kućanskim otpadom.
Od lokalnih vlasti zatražite savjet ili informacije o pogonima za recikliranje.

SR

Заштитите животну средину тако што нећете да одлажете овај производ са кућним отпадом.
Распитајте се код локалног надлежног органа о начину рециклаже и о сабирном центру.

МК

Заштитете ја околината така што нема да се ослободите од производот со домашниот отпад.
Консултирајте се со локалните власти за да дознаете за советите и објектите за рециклирање.

SL

Zaščitite okolje! Okolje varujte tako, da tega izdelka ne zavržete skupaj z gospodinjскими odpadki.
Pri krajevni upravi preverite, kakšne možnosti in kateri obrati za recikliranje obstajajo v vaši okolici.

RO

Protejați mediul înconjurător și nu vă debarasați de acest produs împreună cu deșeurile menajere
Consultați autoritățile locale pentru îndrumări și facilități de reciclare.

BG

Заштитете околната среда и не изхвърляйте този продукт заедно с битовите си отпадъци.
Свържете се с местните власти относно съвети и съоръжения за рециклиране.

LV

Lai saudzētu vidi, neizmetiet šo izstrādājumu kopā ar sadzīves atkritumiem.
Vērsieties vietējās varas iestādēs, lai noskaidrotu, kur un kā tas nododams pārstrādei.

ET

Keskkonda saate kaitsta nii, et ei kõrvalda seda toodet koos olmejäätmetega.
Nüüandeid toote taaskasutusse võtmise ja ümbertöötlemispunktide kohta saate asjaomaselt kohalikult asutuselt.

LT

Saugokite aplinką: nemeskite šio produkto kartu su buitinėmis atliekomis.
Atsižvelkite į savo vietos valdžios rekomendacijas dėl pakartotinio panaudojimo ir sąlygas.

TR

Bu ürününü, evsel atıklarla birlikte atmayarak çevreyi koruyun.
Gerİ dönüşüm tavsiyeleri ve tesisler hakkında bilgi için yerel yönetimle iletişim kurun.

AR

احمي البيئة بعدم التخلص من هذا المنتج مع الخلفات المنزلية.
استشر السلطة المحلية لديك للحصول على نصح بخصوص إعادة تدوير الخلفات ومرافقها.

ID

Jagalah lingkungan dengan tidak membuang produk ini bersama sampah rumah tangga Anda.
Periksa peraturan pemerintah setempat tentang saran dan fasilitas daur ulang.

MS
Lindungi alam sekitar dengan tidak melupuskan produk ini bersama sisa isi rumah anda.
Rujuk pihak berkuasa tempatan anda tentang nasihat dan kemudahan kitar semula.

This device complies with part 15 of the FCC Rules. Operation is subject to the following two conditions:

- (1) This device may not cause harmful interference, and
- (2) this device must accept any interference received, including interference that may cause undesired operation.

NOTE: This equipment has been tested and found to comply with the limits for a Class B digital device, pursuant to part 15 of the FCC Rules. These limits are designed to provide reasonable protection against harmful interference in a residential installation. This equipment generates, uses and can radiate radio frequency energy and, if not installed and used in accordance with the instructions, may cause harmful interference to radio communications. However, there is no guarantee that interference will not occur in a particular installation. If this equipment does cause harmful interference to radio or television reception, which can be determined by turning the equipment off and on, the user is encouraged to try to correct the interference by one or more of the following measures:

- Reorient or relocate the receiving antenna.
- Increase the separation between the equipment and receiver.
- Connect the equipment into an outlet on a circuit different from that to which the receiver is connected.
- Consult the dealer or an experienced radio/TV technician for help.

Caution: changes or modifications not expressly approved by the party responsible for compliance could void the user's authority to operate the equipment.

This device contains licence-exempt transmitter(s)/receiver(s) that comply with Innovation, Science and Economic Development Canada's licence-exempt RSS(s).

Operation is subject to the following two conditions:

- (1) This device may not cause interference.
- (2) This device must accept any interference, including interference that may cause undesired operation of the device.

L'émetteur/récepteur exempt de licence contenu dans le présent appareil est conforme aux CNR d'Innovation, Sciences et Développement économique Canada applicables aux appareils radio exempts de licence. L'exploitation est autorisée aux deux conditions suivantes :

- (1) L'appareil ne doit pas produire de brouillage;
- (2) L'appareil doit accepter tout brouillage radioélectrique subi, même si le brouillage est susceptible d'en compromettre le fonctionnement.

CAN ICES-3 (B)/NMB-3(B)

EN

The LEGO Group hereby declares that above product/products comply with the essential requirements and other relevant provisions of Directive 2014/53/EU. Complete declaration on WWW.LEGO.COM

DE

Hiermit erkl rt die LEGO Gruppe, dass das oben genannte Produkt/die oben genannten Produkte den notwendigen Anforderungen und weiteren relevanten Bestimmungen der Richtlinie 2014/53/EU entspricht bzw. entsprechen. Vollst ndige Erkl rung auf www.LEGO.com.

FR

Par la pr sente, le Groupe LEGO d clare que le(s) produit(s) mentionn (s) ci-dessus est/sont conforme(s) aux exigences essentielles et aux autres dispositions pertinentes de la Directive 2014/53/UE. D claration compl te sur WWW.LEGO.COM

IT

Con la presente, LEGO Group dichiara che il prodotto/prodotti di cui sopra sono conformi ai requisiti essenziali e alle altre disposizioni pertinenti stabiliti dalla Direttiva 2014/53/UE. Dichiarazione completa su WWW.LEGO.COM

NL

De LEGO Groep verklaart bij dezen dat het bovenstaande product/de bovenstaande producten voldoet/voldoen aan de essenti le eisen en overige relevante bepalingen van Richtlijn 2014/53/EU. De volledige verklaring is te vinden op WWW.LEGO.COM

ES

The LEGO Group declara que el producto o los productos anteriores satisfacen los requisitos fundamentales y dem s disposiciones correspondientes de la Directiva 2014/53/UE. La declaraci n completa est  disponible en WWW.LEGO.COM

DA

LEGO Koncernen erkl rer hermed, at produktet/produkterne n vnt ovenfor opfylder de v sentlige krav og andre relevante bestemmelser i direktiv 2014/53/EU. Komplet erkl ring p  www.LEGO.dk

IS

LEGO Group l sir því h r me  yfir a  ofangreind vara/v rur uppfylla grundvallarkr fur og samr mast a rum vi eigandi  kv o um tilskipunar nr. 2014/53/ESB. Yfirl singuna i heild er a  finna   WWW.LEGO.COM

FI

LEGO Group vakuuttaa t ten, ett  edell  mainittu yksi tai useampi tuote on direktiivin 2014/53/EU oleellisten vaatimusten ja ehtojen mukainen. T ydellinen vaatimustenmukaisuusvakuutus on osoitteessa WWW.LEGO.COM

SV

LEGO Koncernen intygar h rmed att ovanst ende produkt/produkter uppfyller de v sentliga kraven och andra relevanta best mmelser i direktiv 2014/53/EU. Fullst ndig f rklaring p  WWW.LEGO.COM

NO

LEGO konsernet erkl rer herved at ovennevnte produkt/produkter oppfyller de obligatoriske kravene og andre relevante bestemmelser i Europaparlaments- og r dsdirektiv 2014/53/EU. Hele erkl ringen ligger p  WWW.LEGO.NO

PT

O LEGO Group declara que o/os produto(s) acima mencionado(s) est /est o em conformidade com os requisitos essenciais e outras disposi es relevantes da Diretiva 2014/53/UE. Declara o completa em WWW.LEGO.COM

EL

 ia της παρούσης ο Όμιλος LEGO Group δηλώνει ότι το/τα παραπάνω προϊόν/προϊόντα συμμορφώνεται/ονται με τις ουσιαστικές απαιτήσεις και άλλες σχετικές διατάξεις της Οδηγίας 2014/53/EE. Η πλήρης δήλωση βρίσκεται στο WWW.LEGO.COM

JA

LEGO Group による上記の製品はすべて、2014 年EU 指令 (2014/53/EU) の基本的な要求事項およびその他の関連既定に準拠しております。準拠宣言の全文はこちら：WWW.LEGO.COM

ZH

乐高集团特此声明，上述产品符合欧盟 2014/53/EU 指令的基本要求和其它有关规定。请访问 WWW.LEGO.COM 网站查看完整声明

KO

레고 그룹은 상기 제품이 2014/53/EU 지침의 필수 요건 및 기타 관련 조항을 준수함을 선언합니다.
자세한 내용은 WWW.LEGO.COM에서 확인할 수 있습니다.

RU

Настоящим LEGO Group заявляет, что указанные выше товары отвечают основополагающим требованиям и иным применимым положениям Директивы 2014/53/EC.
Полный текст см. на сайте WWW.LEGO.COM/RU-RU

PL

Grupa LEGO niniejszym oświadcza, że wymienione produkty są zgodne z zasadniczymi wymaganiami oraz innymi właściwymi postanowieniami dyrektywy 2014/53/UE.
Pełna treść deklaracji na stronie WWW.LEGO.PL

CZ

LEGO Group tímto prohlašuje, že všechny výše uvedené produkty odpovídají základním požadavkům a všem příslušným ustanovením směrnice 2014/53/EU.
Kompletní prohlášení na WWW.LEGO.CZ

SK

LEGO Group týmto vyhlasuje, že vyššie uvedené produkty zodpovedajú základným požiadavkám a všetkým príslušným ustanoveniam smernice 2014/53/EÚ.
Kompletné vyhlásenie na WWW.LEGO.CZ

HU

A LEGO Csoport ezennel kijelenti, hogy a fenti termék/termékek megfelelnek a 2014/53/EU irányelv alapvető követelményeinek és egyéb vonatkozó rendelkezéseinek.
A nyilatkozat teljes szövege itt olvasható: WWW.LEGO.COM

UA

LEGO Group заявляє, що цей продукт чи продукти відповідають головним вимогам та іншим відповідним положенням Директиви 2014/53/EU. Повний текст заяви можна переглянути на сайті WWW.LEGO.COM

HR

LEGO Group ovim izjavljuje da su gore navedeni proizvod/proizvodi sukladni bitnim zahtjevima i drugim odgovarajućim odredbama direktive 2014/53/EU.
Cjelovita izjava nalazi se na WWW.LEGO.COM

SR

Компанија LEGO Group овим путем изјављује да је/су горенаведени производ/и усклађен/и са основним захтевима и другим релевантним одредбама Директиве 2014/53/EU.
Комплетну изјаву можете пронаћи на адреси WWW.LEGO.COM

MK

LEGO Group со ова изјавува дека производот/производителите погоре се во согласност со основните барања и другите релевантни одредби на директивата 2014/53/EC.
Целосна декларација на WWW.LEGO.COM

SL

LEGO Group izjavlja, da izdelek ustreza osnovnim zahtevam in drugim relevantnim določilom Direktive 2014/53/ES.
Celotna deklaracija je na spletni strani WWW.LEGO.COM

RO

Grupul LEGO declară prin prezenta că produsul/produsele de mai sus se conformează cerințelor esențiale și altor prevederi relevante ale Directivei 2014/53/UE.
Declarația completă pe WWW.LEGO.COM

BG

LEGO Group декларира, че посочените продукти по-горе съответстват на основните изисквания и други съответни разпоредби на Директива 2014/53/EC.
Пълна декларация на WWW.LEGO.COM

LV

Ar šo LEGO Group paziņo, ka iepriekšminētais(i) produkts(i) atbilst Direktīvas 2014/53/ES būtiskajām prasībām un citiem saistītajiem noteikumiem.
Pilns deklarācijas teksts pieejams vietnē WWW.LEGO.COM

ET

Käesolevaga teatab LEGO Group, et eespool nimetatud toode/tooted vastavad direktiivi 2014/53/EL olulistele nõuetele ja muudele asjakohastele sätetele.
Täielik deklaratsioon on saadaval aadressil WWW.LEGO.COM

LT

Šiuo dokumentu „LEGO Group“ deklaruoja, kad anksčiau nurodytas (-i) produktas (-ai) atitinka svarbiausius reikalavimus ir kitas 2014/53/ES direktyvos sąlygas.
Visą deklaraciją rasite WWW.LEGO.COM

TR

LEGO Group işbu belge ile yukarıdaki ürünün/ürünlerin 2014/53/EU sayılı direktifin temel gereksinimlerine ve diğer ilgili hükümlerine uygun olduğunu beyan eder. Beyanın tam metnine WWW.LEGO.COM adresinden ulaşabilirsiniz.

AR

تعلمن مجموعة LEGO Group بموجب هذه الوثيقة أن المنتج/المنتجات تتوافق مع المتطلبات الأساسية والأحكام الأخرى ذات الصلة بالتوجيه 2014/53/EU. التصريح كاملاً على الموقع WWW.LEGO.COM

ID

LEGO Group dengan ini menyatakan bahwa produk di atas sesuai dengan persyaratan penting dan ketentuan terkait lainnya dalam Directive 2014/53/EU. Pernyataan selengkapnya tersedia di WWW.LEGO.COM

MS

LEGO Group dengan ini mengumumkan bahawa produk di atas mematuhi keperluan asas dan peruntukan relevan lain dalam Directive 2014/53/EU. Pengisytiharan lengkap di WWW.LEGO.COM

EN CAUTION: Risk of explosion if the battery is replaced by an incorrect type.

DE ACHTUNG: Es besteht Explosionsgefahr, wenn die Batterie durch einen ungeeigneten Batterietyp ersetzt wird.

FR ATTENTION : Risque d'explosion si la batterie est remplacée par un modèle incompatible.

IT ATTENZIONE: rischio di esplosione se la batteria è sostituita con una di tipo errato.

NL VOORZICHTIG: Explosiegevaar indien de batterij wordt vervangen door een onjuist type.

ES PRECAUCIÓN: Sustituir la batería por otra de tipo incorrecto representa un riesgo de explosión.

DA ADVARSEL: Der er risiko for eksplosion, hvis batteriet udskiftes med en forkert type.

IS VARÚÐ: Hættu á sprengingu ef rafhlöðunni er skipt út fyrir rafhlöðu af rangri gerð.

FI VAROITUS: Räjähdyksvaara, jos pariston tilalle vaihdetaan väärän tyyppinen paristo.

SV VARNING: Explosionsrisk om batteriet byts ut mot ett batteri av fel typ.

NO FORSKTIG: Kan eksplodere hvis batteriet skiftes ut med feil type batteri.

PT ATENÇÃO: Risco de explosão se as pilhas forem substituídas por um tipo incorreto.

EL ΠΡΟΣΟΧΗ: Κίνδυνος έκρηξης εάν η μπαταρία αντικατασταθεί με μια άλλη λανθασμένου τύπου.

JA 注意: 誤った種類の電池を挿入すると爆発する恐れがあります。

ZH 注意事项: 如果所更换的电池类型不正确, 则存在爆炸的风险。

KO 주의: 출고 시 규격 이외의 배터리로 교체할 경우 폭발의 위험이 있습니다.

RU ВНИМАНИЕ! Установка элемента питания неправильного типа может привести к его взрыву.

PL UWAGA: Zastosowanie nieprawidłowego typu baterii stwarza zagrożenie wybuchem.

CZ POZOR: V případě nahrazení baterie nesprávným typem hrozí riziko výbuchu.

SK VAROVANIE: Ak batériu nahradíte nesprávnym typom, hrozí riziko výbuchu.

HU VIGYÁZAT! Robbanásveszély, ha az akkumulátort nem megfelelő típusúra cserélik.

UA ОБЕРЕЖНО! Якщо вставити невідповідний тип батарейки, може статися вибух.

HR OPREZ: Opasnost od eksplozije ako se baterija zamijeni vrstom koja nije propisana.

SR OPREZ: Opasnost od eksplozije ako se baterija zamjeni neodgovarajućom vrstom.

MK ВНИМАНИЕ: Има ризик од експлозија, ако батеријата е заменета со погрешен тип.

SL POZOR: Če vstavite baterijo napačnega tipa, tvegate, da bo eksplodirala.

RO ATENȚIE: risc de explozie dacă bateria este înlocuită cu una de un tip incorect.

BG ВНИМАНИЕ: Има риск от експлозия, ако батерията бъде заменена с такава от неправилен тип.

LV UZMANĪBU! Ja baterija tiek nomainīta ar nepareiza tipa bateriju, pastāv sprādziena risks.

ET ETTEVAATUST! Plahvatusoht, kui patarei asendatakse vale tüüpi patareiga.

LT ATSARGIA! Istaciūs netinkamo tipo elementą, gali kilti sprogimo pavojus.

TR UYARI: Yanlış türde pil kullanılırsa patlama riski bulunur.

AR تنبيه: خطر الانفجار في حالة استبدال البطارية بنوع غير صحيح.

ID HATI-HATI: Risiko ledakan dapat timbul jika baterai diganti dengan jenis yang berbeda.

MS PERINGATAN: Risiko letupan jika bateri ditukarkan dengan jenis bateri yang salah.

La operación de este equipo está sujeta a las siguientes dos condiciones:
 (1) es posible que este equipo o dispositivo no cause interferencia perjudicial y
 (2) este equipo o dispositivo debe aceptar cualquier interferencia, incluyendo la que pueda causar su operación no deseada.



Este equipamento não tem direito à proteção contra interferência prejudicial e não pode causar interferência em sistemas devidamente autorizados.

第十二條

經型式認證合格之低功率射頻電機，非經許可，公司、商號或使用者均不得擅自變更頻率、加大功率或變更原設計之特性及功能。

第十四條

低功率射頻電機之使用不得影響飛航安全及干擾合法通信；經發現有干擾現象時，應立即停用，並改善至無干擾時方得繼續使用。前項合法通信，指依電信法規定作業之無線電通信。低功率射頻電機須忍受合法通信或工業、科學及醫療用電波輻射性電機設備之干擾

有毒有害物质/元素的名称及含量表						
根据中国<电子信息产品污染控制管理办法>						
有毒有害物质/元素						
部件名称	铅 (Pb)	汞 (Hg)	镉 (Cd)	六价铬 (Cr(VI))	多溴联苯 (PBB)	多溴二联苯 (PBDE)
印刷电路板组件	X	O	O	O	O	O

本表格依据 SJ/T 11364 的规定编制。
 O: 表示该有害物质在该部件所有均质材料中的含量均在 GB/T 26572 规定的限量要求以下。
 X: 表示该有害物质至少在该部件的某一均质材料中的含量超出 GB/T 26572 规定的限量要求。
 (由于技术原因目前尚未能替代化。除非破坏产品，否则消费者接触不到相关组件。)

- EN Please retain the leaflet and packaging as they contain important information
 DE Broschüre und Verpackung bitte aufbewahren, sie enthalten wichtige Informationen
 FR Veuillez conserver le dépliant et l'emballage, car ils contiennent des informations importantes
 IT Conserva l'opuscolo e la confezione in quanto contengono informazioni importanti
 NL Bewaar a.u.b. de folder en verpakking: die bevatten belangrijke informatie
 ES Conserve el folleto y el embalaje; contienen información importante
 DA Gem hæftet og emballagen, da de indeholder vigtige oplysninger
 IS Geymið bæklinginn og umbúðirnar þar sem þau innihalda mikilvægar upplýsingar
 FI Säilytä esite ja pakkaus, koska ne sisältävät tärkeää tietoa
 SV Spara broschyren och förpackningen eftersom de innehåller viktig information
 NO Heftet og emballasjen inneholder viktig informasjon og skal beholdes
 PT Por favor guarde o folheto e a embalagem, pois contém informação importante
 EL Κρατήστε το φυλλάδιο και τη συσκευασία γιατί περιέχουν σημαντικές πληροφορίες
 JA 説明書とパッケージには重要な情報が含まれていますので保管しておいてください
 ZH 说明书和包装均包含重要信息，请妥善保管
 KO 중요한 정보가 담겨 있으므로 리플릿과 포장물 보관해두세요
 RU Пожалуйста, сохраните эту брошюру и упаковку, поскольку они содержат важную информацию
 PL Prosimy zachować ulotkę i opakowanie, ponieważ zawierają one ważne informacje
 CZ Ponechte si prosím leták i obal, neboť obsahují důležité informace
 SK Ponechajte si prosím leták aj obal, pretože obsahujú dôležité informácie
 HU Kérjük, őrizze meg a szórólapot és a csomagolást, mert fontos tudnivalók tartalmaznak
 UA Будь ласка, зберігайте вкладиш та упаковку, оскільки вони містять важливу інформацію
 HR Spremite letak i ambalažu jer sadrže važne obavijesti
 SR Molimo da sačuvate uputstvo i pakovanje jer se na njima nalaze važne informacije
 MK Чувајте ги брошурата и амбалажата бидејќи содржат важна информација
 SL Prosimo, da brošurico in embalažo shranite, saj vključujeta pomembne informacije
 RO Vă rugăm să păstrați prospectul și ambalajul intrucât conțin informații importante
 BG Запазете листовката и опаковката, тъй като съдържат важна информация
 LV Lūdzu, saglabājiet bukletu un iepakojumu, jo uz tā ir norādīta svarīga informācija
 ET Hoidke infoleht ja pakend alles, sest nendele on märgitud oluline teave
 LT Išsaugokite informacinį lapelį ir pakuotę, nes ant jų pateikiama svarbi informacija
 TR Önemli bilgiler içerdigi için broşürü ve ambalajı saklayın
 AR إجراء الاحتفاظ بالنشرة والغلاف لاحتوائهما على معلومات هامة
 ID Harap simpan brosur dan kemasan ini karena berisi informasi penting
 MS Sila simpan risalah dan pembungkusan kerana ia mengandungi maklumat penting



Rebuild
the
world™



WIN

GO TO WWW.LEGO.COM/PRODUCTFEEDBACK AND
GIVE US YOUR SHORT **FEEDBACK** ABOUT THIS
LEGO® SET FOR A CHANCE TO WIN
A COOL LEGO PRIZE.

Terms & Conditions apply

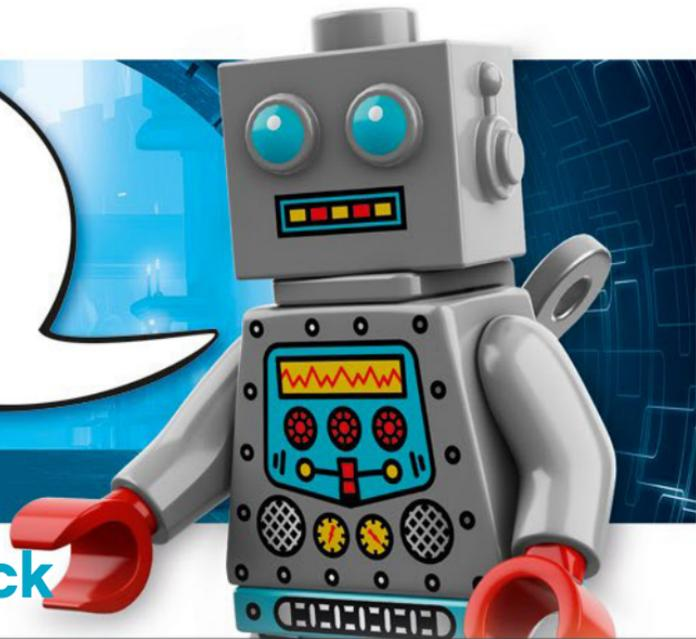

LEGO.com/productfeedback

GEWINNE

Erzähle uns auf
www.LEGO.com/productfeedback

etwas über die Erfahrungen, die du mit
diesem LEGO® Set gemacht hast, und
sichere dir die Chance auf einen coolen
LEGO Preis!

Es gelten die Teilnahmebedingungen

GAGNE

Rends-toi sur
www.LEGO.com/productfeedback

et donne-nous quelques commentaires sur
ce produit LEGO® pour avoir une chance
de gagner un prix LEGO !

Voir Conditions Générales

GANAN

Visita
www.LEGO.com/productfeedback

y envíanos tu opinión acerca de este set
LEGO®. ¡Participarás en el sorteo de un
premio LEGO!

Términos y Condiciones aplicables

获取奖品

登录
www.LEGO.com/productfeedback

给出关于此乐高®套装的简短反馈，
就有机会获得炫酷乐高奖品

《条款及条件》适用

LEGO, the LEGO logo and the Brick and Knob configurations are trademarks and/or copyrights of the LEGO Group. ©2021 The LEGO Group.
TM & © 2021 Nintendo.