

NVR-108LS-P8



Key Features

- Support Ultra 265/H.265/H.264 video formats
- 8-channel input
- Third-party IP cameras supported with ONVIF conformance: Profile S, Profile G, Profile T
- Support 1-ch HDMI, 1-ch VGA
- HDMI and VGA simultaneous output
- Up to 5MP resolution recording
- 1 SATA HDD up to 6TB
- Support cloud upgrade

Specifications

Model	NVR-108LS-P8
Video/Audio Input	
IP Video Input	8-ch
Network	
Incoming Bandwidth	50Mbps
Outgoing Bandwidth	40Mbps
Remote Users	128
Protocols	P2P, NTP, DHCP, PPPoE
Video/Audio Output	
HDMI/VGA Output	HDMI: 1920x1080p/60Hz, 1920x1080p/50Hz, 1600x1200/60Hz, 1280x1024/60Hz, 1280x720/60Hz, 1024x768/60Hz VGA: 1920x1080p/60Hz, 1920x1080p/50Hz, 1600x1200/60Hz, 1280x1024/60Hz, 1280x720/60Hz, 1024x768/60Hz
Recording Resolution	5MP/4MP/3MP/1080p/960p/720p/D1/2CIF/CIF

Synchronous Playback	8-ch
Corridor Mode Screen	3/4/5/7/9
Decoding	
Decoding format	Ultra 265/H.265/H.264
Liveview/Playback	5MP/4MP/3MP/1080p/960p/720p/D1/2CIF/CIF
Capability	1 x 5MP@30, 2 x 4MP@25, 2 x 3MP@30, 4 x 1080p@25, 8 x 960p@25, 8 x 720p@30
Hard Disk	
SATA	1 SATA interface
Capacity	up to 6TB for each disk
External Interface	
Network Interface	1 RJ45 10M/100M self-adaptive Ethernet Interface
USB Interface	Rear panel: 2 x USB2.0
Supported Standard	IEEE 802.3at, IEEE 802.3af
External Interface	
Interface	8 independent 100 Mbps PoE network interfaces
Max Power	Max 30W for single port Max 108W in total (13.5W for each)
Supported Standard	IEEE 802.3at, IEEE 802.3af
General	
Power Supply	52V DC Power Consumption: ≤9 W (without HDD)
Working Environment	-10°C ~ +55°C (+14°F ~ +131°F), Humidity ≤ 90% RH (non-condensing)
Dimensions (W×D×H)	270mm × 205mm × 45mm (10.6"×8.1"×1.6")
Weight (without HDD)	0.8kg (1.76 lb)

Dimensions

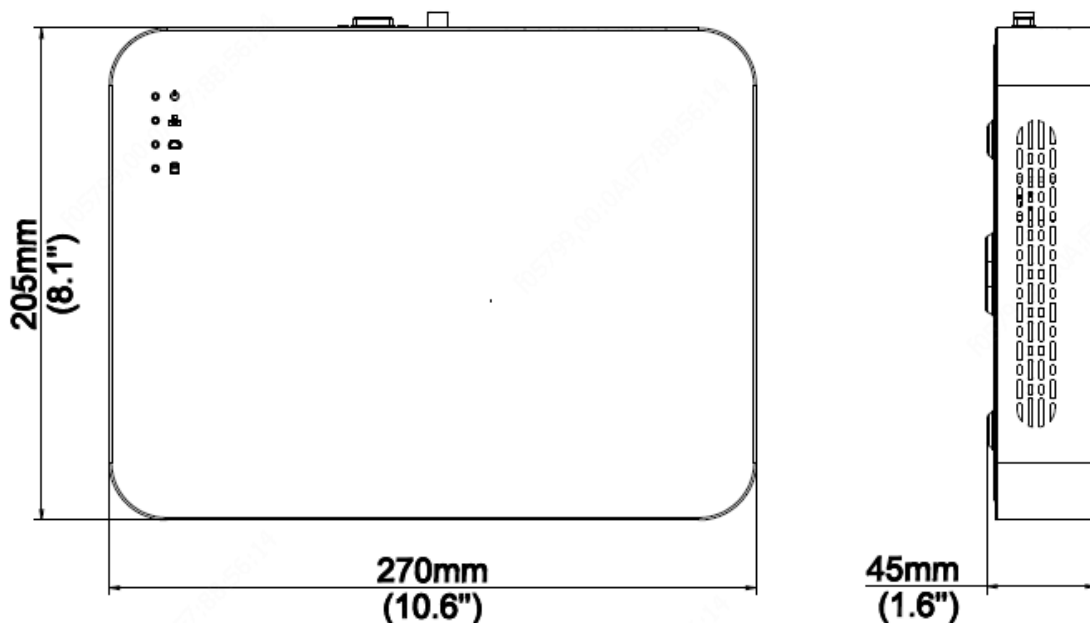

Rear Panel

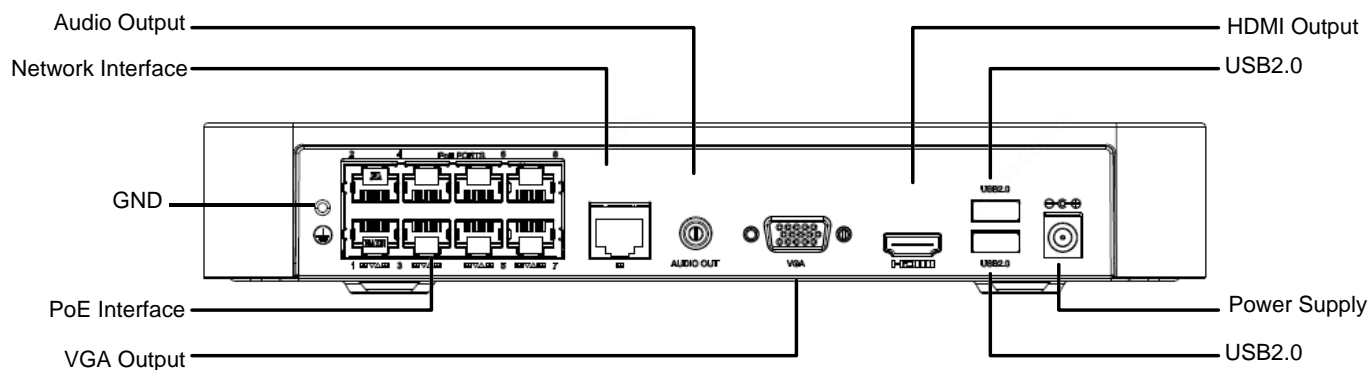

www.uniview.com/uniarch

©2019 Zhejiang Uniview Technologies Co., Ltd. All rights reserved.

*Product specifications and availability are subject to change without notice.